



**UNIVERSAL ROBOTS**

# User Manual

UR12e





The information contained herein is the property of Universal Robots A/S and shall not be reproduced in whole or in part without prior written approval of Universal Robots A/S. The information herein is subject to change without notice and should not be construed as a commitment by Universal Robots A/S. This document is periodically reviewed and revised.

Universal Robots A/S assumes no responsibility for any errors or omissions in this document.

Copyright © 2009-2025 by Universal Robots A/S.

The Universal Robots logo is a registered trademark of Universal Robots A/S.



# 1. Preface

---

## Introduction

Congratulations on the purchase of your new Universal Robots robot, that consists of the robot arm (manipulator), Control Box and the Teach Pendant.

Originally designed to mimic the range of motion of a human arm, the robot arm is composed of aluminium tubes, articulated by six joints, allowing for a high range of flexibility in your automation installation.

The Universal Robots patented programming interface, PolyScope, allows you to create, load and run your automation applications.

---

## About this manual

This manual contains safety information, guidelines for safe use, and instructions to mount the robot arm, Control Box and Teach Pendant. You can also find instructions for how to begin to install and how to start programming the robot.

Read and adhere to the intended uses. Perform a risk assessment. Install and use in accordance with the electrical and mechanical specifications provided in this user manual.

Risk assessment requires an understanding of the hazards, risks and risk reduction measures for the robot application. Robot integration can require a basic level of mechanical and electrical training.

---

## Content disclaimer

Universal Robots A/S continues to improve the reliability and performance of its products, and as such reserves the right to upgrade products, and product documentation, without prior warning. Universal Robots A/S takes every care to ensure the content of the User Manual/s is precise and correct, but takes no responsibility for any errors or missing information.

This manual does not contain warranty information.

---

## Online manuals

Manuals, guides and handbooks can be read online. We have gathered a large number of documents at <https://www.universal-robots.com/manuals>

- PolyScope Software Handbook with descriptions and instructions for the software
  - The Service Handbook with instructions for troubleshooting, maintenance and repair
  - The Script Directory with scripting for in depth programming
-

**UR+** The online showroom UR+[www.universal-robots.com/plus](http://www.universal-robots.com/plus) provides cutting-edge products to customize your UR robot application. You can find everything you need in one place – from tools and accessories to software.

UR+ products connect to and work with UR robots to ensure simple set-up and an overall smooth user experience. All UR+ products are tested by UR.

You can also access the UR+ Partner Program via our software platform [plus.universal-robots.com](http://plus.universal-robots.com) to design more user-friendly products for UR robots.

---

**Academy** The UR Academy site [academy.universal-robots.com](http://academy.universal-robots.com) offers a variety of training opportunities.

---

**myUR** The myUR portal allows you to register all your robots, keep track of service cases and answer general support questions.

Sign into [myur.universal-robots.com](http://myur.universal-robots.com) to access the portal.

In the myUR portal, your cases are handled either by your preferred distributor, or escalated to Universal Robots Customer Service teams.

You can also subscribe to robot monitoring and manage additional user accounts in your company.

---

**Developer suite** The UR Developer Suite [universal-robots.com/products/ur-developer-suite](http://universal-robots.com/products/ur-developer-suite) is a collection of all the tools needed to build an entire solution, including developing URCaps, adapting end-effectors, and integrating hardware.

---

**Support** The support site [www.universal-robots.com/support](http://www.universal-robots.com/support) contains other language versions of this manual

---

**UR forums** The UR Forum [forum.universal-robots.com](http://forum.universal-robots.com) allows robot enthusiasts of all skill levels to connect to UR and each other, to ask questions and to exchange information. While the UR Forum was created by UR+ and our admins are UR employees, the majority of the content is created by you, the UR Forum user.

---

**Address** Universal Robots A/S  
Energivej 51  
DK-5260 Odense Denmark  
Tel.: +45 89 93 89 89  
Please see the official Universal Robots website for regional offices.

---



# Contents

<b>1. Preface</b> .....	<b>6</b>
<b>2. Liability and Intended Use</b> .....	<b>15</b>
2.1. Limitation of Liability .....	15
2.2. Intended Use .....	15
<b>3. Your Robot</b> .....	<b>18</b>
3.1. Technical Specifications UR12e .....	18
3.2. What Is In The Box .....	19
3.2.1. Robot Arm .....	19
3.2.2. Control Box .....	20
3.2.3. Teach Pendant with 3-Position Enabling Device .....	22
3.2.4. PolyScope Overview .....	26
<b>4. Safety</b> .....	<b>30</b>
4.1. General .....	30
4.2. Safety Message Types .....	31
4.3. General Warnings and Cautions .....	32
4.4. Integration and Responsibility .....	34
4.5. Stop Categories .....	34
<b>5. Lifting and Handling</b> .....	<b>35</b>
5.1. Robot Arm .....	39
5.2. Control Box and Teach Pendant .....	39
<b>6. Assembly and Mounting</b> .....	<b>41</b>
6.1. Securing the Robot Arm .....	42
6.2. Dimensioning the Stand .....	44
6.3. Mounting Description .....	46
6.3.1. Control Box Mounting .....	48
6.3.2. Control Box Clearance .....	49
6.4. Workspace and Operating Space .....	50
6.4.1. Singularity .....	51
6.4.2. Fixed and Movable Installation .....	52
6.5. Robot Connections: Base Flange Cable .....	53
6.6. Robot Connections: Robot Cable .....	54
6.7. Mains Connections .....	55
<b>7. First Boot</b> .....	<b>57</b>
7.1. Powering On the Robot .....	58
7.2. Inserting the Serial Number .....	58
7.3. Confirming the Safety Configuration .....	59



- 7.4. Starting the Robot Arm ..... 59
- 7.5. Verifying the Robot Arm Mount ..... 61
- 7.6. Adjusting the Robot Arm Mount ..... 61
- 7.7. Freedrive ..... 63
  - 7.7.1. Freedrive Panel ..... 65
- 7.8. Power Down The Robot ..... 66
- 8. Installation ..... 67**
  - 8.1. Electrical Warnings and Cautions ..... 67
  - 8.2. Control Box Connection Ports ..... 69
  - 8.3. Ethernet ..... 70
  - 8.4. 3PE Teach Pendant Installation ..... 71
    - 8.4.1. Hardware Installation ..... 71
  - 8.5. Controller I/O ..... 73
    - 8.5.1. Digital Input and Output ..... 75
    - 8.5.2. I/O Interface Control ..... 76
    - 8.5.3. Using the I/O Tab ..... 77
    - 8.5.4. Drive Power Indicator ..... 79
  - 8.6. Safety I/O ..... 80
    - 8.6.1. I/O Signals ..... 83
    - 8.6.2. I/O Setup ..... 87
    - 8.6.3. Using I/O for Mode Selection ..... 90
    - 8.6.4. Three Position Enabling Device ..... 91
  - 8.7. General Purpose Digital I/O ..... 92
    - 8.7.1. Remote ON/OFF control ..... 93
  - 8.8. General Purpose Analog I/O ..... 94
    - 8.8.1. Analog Input: Communication Interface ..... 95
- 9. End Effector Integration ..... 96**
  - 9.1. Maximum Payload ..... 96
  - 9.2. Securing Tool ..... 98
  - 9.3. Tool I/O ..... 99
    - 9.3.1. Tool I/O Installation Specifications ..... 101
    - 9.3.2. Tool Power Supply ..... 102
    - 9.3.3. Tool Digital Inputs ..... 102
    - 9.3.4. Tool Digital Outputs ..... 104
    - 9.3.5. Tool Analogue Inputs ..... 105
  - 9.4. Set Payload ..... 106
    - 9.4.1. Payload ..... 108
- 10. Configuration ..... 111**
  - 10.1. Quick System Start-up ..... 111

10.2. Safety-related Functions and Interfaces .....	112
10.2.1. Passwords .....	113
10.2.2. Setting a Software Safety Password .....	116
10.2.3. Configurable Safety Functions .....	117
10.2.4. Safety Functions .....	119
10.2.5. Safety Parameter Set .....	120
10.3. Software Safety Configuration .....	122
10.3.1. Changing the Software Safety Configuration .....	124
10.3.2. Applying a New Software Safety Configuration .....	124
10.3.3. Safety Configuration without Teach Pendant .....	125
10.3.4. Software Safety Modes .....	126
10.3.5. Software Safety Limits .....	127
10.3.6. Safe Home Position .....	130
10.4. Software Safety Restrictions .....	132
10.4.1. Tool Direction Restriction .....	138
10.4.2. Tool Position Restriction .....	140
<b>11. The First Program .....</b>	<b>144</b>
11.1. Run Tab .....	146
11.2. Move Robot into Position .....	149
11.3. Using the Program Tab .....	150
11.4. Program Tree Toolbar .....	152
11.5. Using Selected Program Nodes .....	153
11.6. Using Basic Program Nodes .....	154
11.7. Basic Program Nodes: Move .....	154
11.8. Basic Program Nodes: Waypoints .....	160
11.9. Using the Move Tab .....	162
11.10. Pose Editor .....	164
<b>12. Cybersecurity Threat Assessment .....</b>	<b>166</b>
12.1. General Cybersecurity .....	166
12.2. Cybersecurity Requirements .....	166
12.3. Cybersecurity Hardening Guidelines .....	168
<b>13. Communication Networks .....</b>	<b>169</b>
13.1. MODBUS .....	170
13.2. EtherNet/IP .....	174
13.3. PROFINET .....	174
13.4. PROFI-safe .....	175
13.5. UR Connect .....	180
<b>14. Risk Assessment .....</b>	<b>181</b>
14.1. Pinch Hazard .....	184



14.2. Stopping Time and Stopping Distance .....	185
<b>15. Emergency Events .....</b>	<b>190</b>
15.1. Emergency Stop .....	190
15.2. Movement Without Drive Power .....	191
15.3. Modes .....	192
15.3.1. Recovery Mode .....	194
15.3.2. Backdrive .....	194
<b>16. Commissioning .....</b>	<b>199</b>
<b>17. Transportation .....</b>	<b>200</b>
17.1. Put in Box Predefined Position .....	201
17.2. Transportation Without Packaging .....	201
17.3. Teach Pendant Storage .....	202
17.4. Long Term Storage .....	203
<b>18. Maintenance and Repair .....</b>	<b>204</b>
18.1. Testing Stopping Performance .....	205
18.2. Robot Arm Cleaning and Inspection .....	205
18.3. Cleaning TP and CB .....	209
18.4. Log Tab .....	211
18.5. Program and Installation Manager .....	214
18.6. Accessing Robot Data .....	216
18.7. New Software Installation .....	217
<b>19. Disposal and Environment .....</b>	<b>218</b>
<b>20. Declarations and Certifications .....</b>	<b>220</b>
20.1. Declaration of Incorporation (original) .....	221
20.2. Certifications UR12e .....	222
20.3. Certificates UR12e .....	224
<b>21. Safety Functions Table .....</b>	<b>229</b>
21.1. Table 1a .....	237
21.2. Table 2 .....	238



## 2. Liability and Intended Use

### 2.1. Limitation of Liability

**Description** Any information provided in this manual must not be construed as a warranty, by UR, that the industrial robot will not cause injury or damage, even if the industrial robot complies with all safety instructions and information for use.

### 2.2. Intended Use

**Description**



**NOTICE**

Universal Robots takes no responsibility and assumes no liability for unapproved uses of its robots or uses for which its robots are not intended and Universal Robots will provide no support for unintended uses.



**READ MANUAL**

Failure to use the robot in accordance with the intended use can result in hazardous situations.

- Read and follow the recommendations for intended use and the specifications provided in the User Manual.

Universal Robots robots are intended for industrial use, to handle tools/end effectors and fixtures, or to process or transfer components or products.

All UR robots are equipped with safety functions, which are purposely designed to enable collaborative applications, where the robot application operates together with a human. The safety function settings must be set to the appropriate values as determined by the robot application risk assessment.

The robot and Control Box are intended for inside use where, normally, only non-conductive pollution occurs i.e. Pollution degree 2 environments.

Collaborative applications are only intended for non-hazardous applications, where the complete application, including tool/end effector, work piece, obstacles and other machines, is low risk according to the risk assessment of the specific application.

**WARNING**

Using UR robots or UR products outside of the intended uses can result in injuries, death and/or property damage. Do not use the UR robot or products for any of the below unintended uses and applications:

- Medical use, i.e. uses relating to disease, injury or disability in humans including the following purposes:
    - Rehabilitation
    - Assessment
    - Compensation or alleviation
    - Diagnostic
    - Treatment
    - Surgical
    - Healthcare
    - Prosthetics and other aids for the physically impaired
    - Any use in proximity to patient/s
  - Handling, lifting, or transporting people
  - Any application requiring compliance with specific hygienic and/or sanitation standards, such as proximity or direct contact with food, beverage, pharmaceutical, and /or cosmetic products.
    - UR joint grease leaks, and can also be released as vapor into the air.
    - UR joint grease is not “food grade”.
    - UR robots do not meet any food, National Sanitization Foundation (NSF), Food and Drug Administration (FDA), or hygienic design standards.
- Hygienic standards, for example ISO 14159 and EN 1672-2, require a hygiene risk assessment be conducted.
- Any use, or any application, deviating from the intended use, specifications, and certifications of UR robots or UR products.
  - Misuse is prohibited as the result could be death, personal injury, and /or property damage

UNIVERSAL ROBOTS EXPRESSLY DISCLAIMS ANY EXPRESS OR IMPLIED WARRANTY OF FITNESS FOR ANY PARTICULAR USE.

**WARNING**

Failure to consider the added risks due to the reach, payloads, operating torques and speeds associated with robot application, can result in injury or death.

- Your application risk assessment shall include the risks associated with the application's reach, motion, payload and speed of the robot, end effector and workpiece.

**WARNING**

Do not modify or alter e-Series robots end caps. A modification can create unforeseen hazards. All authorized disassembling and reassembling shall be done at a UR service center, or can be done according to the newest version of all relevant service manuals by skilled persons.

## 3. Your Robot

### 3.1. Technical Specifications UR12e

Robot type	UR12e
Maximum payload	12.5 kg / 27.5 lb
Reach	1300 mm / 51.2 in
Degrees of freedom	6 rotating joints
Programming	PolyScope 5 GUI on 12" touchscreen or PolyScope X GUI on 12" touchscreen
Power consumption (average)	615 W Approx. 350 W using a typical program
Ambient temperature range	0-50 °C. At ambient temperatures above 35°C, the robot may operate at reduced speed and performance.
Safety functions	20 configurable safety functions. PLd Category 3 in accordance with: EN ISO 13849-1.
IP classification	IP54
Noise	Robot Arm: Less than 60 dB(A) Control Box: Less than 50 dB(A)
Tool I/O ports	2 digital in, 2 digital out, 2 analog in
Tool I/O power supply & voltage	2 A (Dual pin) 1 A (Single pin) & 12 V/24 V
Force Torque sensor accuracy	5.5 N
Speed	Base and Shoulder joints: Max 120 °/s. All other joints: Max 180 °/s . Tool: Approx. 1 m/s / Approx. 39.4 in/s.
Pose repeatability	± 0.05 mm / ± 0.0019 in (1.9 mils) per ISO 9283
Joint ranges	± 360 ° for all joints except Elbow ± 160 °
Footprint	Ø190 mm / 7.5 in
Materials	Aluminium, PC/ASA plastic
Robot arm weight	33.3 kg / 73.5 lb
System update frequency	500 Hz
Control Box size (W × H × D)	460 mm × 449 mm × 254 mm / 18.2 in × 17.6 in × 10 in
Control Box I/O ports	16 digital in, 16 digital out, 2 analog in, 2 analog out
Control Box I/O power supply	24 V 2 A in Control Box
Communication	MODBUS TCP & Ethernet/IP adapter, PROFINET, USB 2.0, USB 3.0
Tool Communication	RS-485

Control Box power source	100-240 VAC, 47-440 Hz
Short-Circuit Current Rating (SCCR)	200A
TP cable: Teach Pendant to Control Box	4.5 m / 177 in
Robot Cable: Robot Arm to Control Box (options)	Standard (PVC) 1 m/39 in x 12.1 mm. Standard (PVC) 2 m/78.7 in x 12.1 mm. Standard (PVC) 3 m/118 in x 12.1 mm. Standard (PVC) 6 m/236 in x 12.1 mm. Standard (PVC) 12 m/472.4 in x 12.1 mm. High flex (PUR) 6 m/236 in x 13.4 mm. High flex (PUR) 12 m/472.4 in x 13.4 mm. High flex (PUR) 6 m/236 in x 14.6 mm. High flex (PUR) 12 m/472.4 in x 14.6 mm.

## 3.2. What Is In The Box

### In the boxes

- Robot arm
- Control Box
- Teach Pendant or a 3PE Teach Pendant
- Mounting bracket for the Control Box
- Mounting bracket for the 3PE Teach Pendant
- Key for opening the Control Box
- Cable for connecting the robot arm and the Control Box (multiple options available depending on robot size)
- Mains cable or power cable compatible with your region
- Round sling or lifting sling (depending on robot size)
- Tool cable adapter (depending on robot version)
- This manual

### 3.2.1. Robot Arm

#### About the robot arm

The Joints, Base and Tool Flange are the main components of the robot arm. The controller coordinates joint motion to move the robot arm.

Attaching an end effector (tool) to the Tool Flange at the end of the robot arm, allows the robot to manipulate a workpiece. Some tools have a specific purpose beyond manipulating a part, for example, QC inspection, applying adhesives and welding.

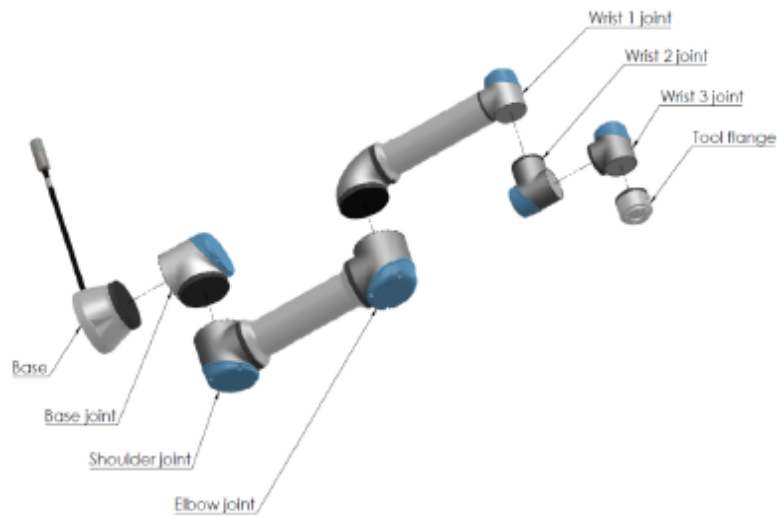

*The main components of the robot arm.*

- **Base:** where the robot arm is mounted.
- **Shoulder** and **Elbow:** make larger movements.
- **Wrist 1** and **Wrist 2:** make finer movements.
- **Wrist 3:** where the tool is attached to the Tool Flange.

The robot is partly completed machinery, as such a Declaration of Incorporation is provided. A risk assessment is required for each robot application.

---

### 3.2.2. Control Box

---

#### **About the Control Box**

The Control Box houses the connection ports and Controller Inputs and Outputs (I/O) used in robot arm programs and installations. The connection ports are used for external connections. The I/O are groups of electrical interfaces used for communication and configuration.



*External connections ports.*

Safety		Remote		Power		Configurable Inputs		Configurable Outputs		Digital Inputs		Digital Outputs		Analog	
Emergency Stop	24V	12V		PWR	24V	24V	0V	0V	24V	24V	0V	0V	0V	0V	AG
	EI0	GND		GND	CI0	CI4	CO0	CO4	D10	D14	DO0	DO4	DO0	DO4	AI0
	EI1	ON		24V	24V	24V	0V	0V	24V	24V	0V	0V	0V	0V	AI1
	EI1	OFF		0V	CI1	CI5	CO1	CO5	D11	D15	DO1	DO5	DO1	DO5	AI1
Safeguard Stop	24V				24V	24V	0V	0V	24V	24V	0V	0V	0V	0V	AG
	SI0	DI11	DI10	DI9	CI2	CI6	CO2	CO6	D12	D16	DO2	DO6	DO2	DO6	AO0
	SI1			24V	24V	24V	0V	0V	24V	24V	0V	0V	0V	0V	AG
	SI1			0V	CI3	CI7	CO3	CO7	D13	D17	DO3	DO7	DO3	DO7	AO1

*Input and Output (I/O) groups.*

For detailed descriptions of the Control Box connection ports and the Controller I/O, see the Installation.

### 3.2.3. Teach Pendant with 3-Position Enabling Device

#### Description

Depending on the robot generation, your Teach Pendant can include a built-in 3PE device. This is called a 3-Position Enabling Teach Pendant (3PE TP). Higher payload robots can only use the 3PE TP.

If you are using a 3PE TP, the buttons are located on the underside of the Teach Pendant, as illustrated below. You can use either button, according to your preference.

If the Teach Pendant is disconnected, you are required to connect and configure an external 3PE device. The 3PE TP functionality extends to the PolyScope interface, where there are additional functions in the Header.



#### NOTICE

- If you have bought a UR15, UR20 or UR30 robot, a Teach Pendant without the 3PE device will not work.
- Using a UR15, UR20, or UR30 robot requires an external enabling device or a 3PE Teach Pendant when programming, or teaching, within the reach of the robot application. See ISO 10218-2.
- The 3PE Teach Pendant is not included with the purchase of the OEM Control Box, so enabling device functionality is not provided.

#### Overview of TP

1. Power button
2. Emergency Stop button
3. USB port (comes with a dust cover)
4. 3PE buttons

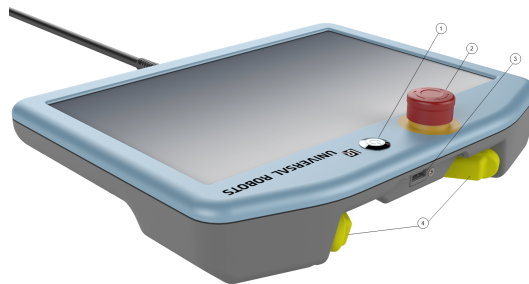

**Freedrive** A Freedrive robot symbol is located under each 3PE button, as illustrated below.

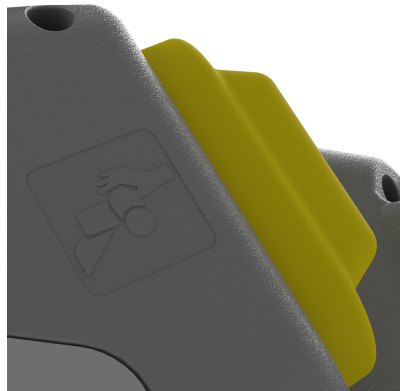

## 3PE Teach Pendant Button Functions

### Description



#### NOTICE

The 3PE buttons are only active in Manual mode. In Automatic mode, robot movement does not require 3PE button action.

The table below describes the functions of the 3PE buttons.

Position		Description	Action
1	Release	There is no pressure on the 3PE button. It is not pressed.	Robot movement is stopped in Manual mode. Power is not removed from the robot arm and the brakes remain released.
2	Light-press (Grip lightly)	There is some pressure on the 3PE button. It is pressed to a middle point.	Allows your program to play when the robot is in Manual mode.
3	Tight-press (Grip tightly)	There is full pressure on the 3PE button. It is pressed all the way down.	Robot movement is stopped in Manual mode. Robot is in 3PE Stop.

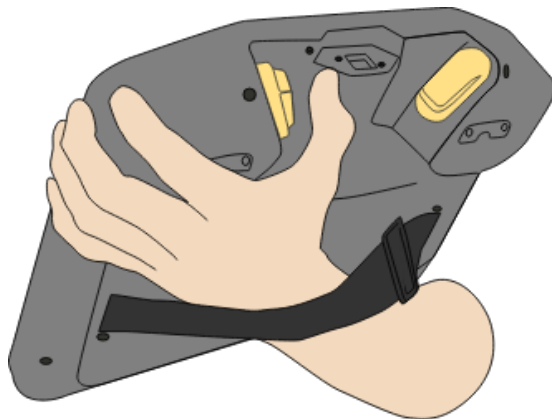

Button release



Button press

---

## Using the 3PE Buttons

---

### Using the 3PE

To play a program

1. On PolyScope, ensure the robot is set to **Manual mode**, or switch to **Manual mode**.
2. Maintain a light-press on the 3PE button.
3. On PolyScope, tap **Play** to run the program.

The program runs if the robot arm is in the first position of the program.  
If the robot is not in the first position of the program, the **Move Robot into Position screen** appears.

To stop a program

1. Release the 3PE button or, on PolyScope, tap **Stop**.

To pause a program

1. Release the 3PE button, or, in PolyScope, tap **Pause**.

To continue the program execution, keep the 3PE button light pressed and tap **Resume** in PolyScope.

---

## Freedrive with 3PE Buttons

---

### Description

Freedrive allows the robot arm to be manually pulled into desired positions and/or poses.

---

### Use the 3PE button to freedrive the robot arm

Rapidly light-press, release, light-press again and keep holding the 3PE button in this position.

Now you can pull the robot arm into a desired position, while the light-press is maintained.

---

## Using Move Robot into Position

---

### Description

Move Robot into Position allows the robot arm to move to that start position, after you complete a program. The robot arm must be in the start position before you can run the program.

---

### Move into position

To use the 3PE button to move the robot arm into position:

1. When your program is complete, press **Play**.
2. Select **Play from beginning**.  
On PolyScope, the **Move Robot into Position** screen appears displaying robot arm movement.
3. Light-press and hold the 3PE button.
4. Now, on PolyScope, press and hold **Automove** for the robot arm to move to the start position.  
The Play Program screen appears.
5. Maintain a light-press on the 3PE button to run your program.  
Release the 3PE button to stop your program.

## 3.2.4. PolyScope Overview

### Description

PolyScope is the Graphical User Interface (GUI) on the **Teach Pendant** that operates the robot arm via a touch screen. You create, load and execute programs for the robot in PolyScope. The PolyScope interface is divided as shown in the following illustration:

- A: **Header** with icons/tabs that make interactive screens available to you.
- B: **Footer** with buttons that control your loaded program/s.
- C: **Screen** with fields and options to manage and monitor robot actions.

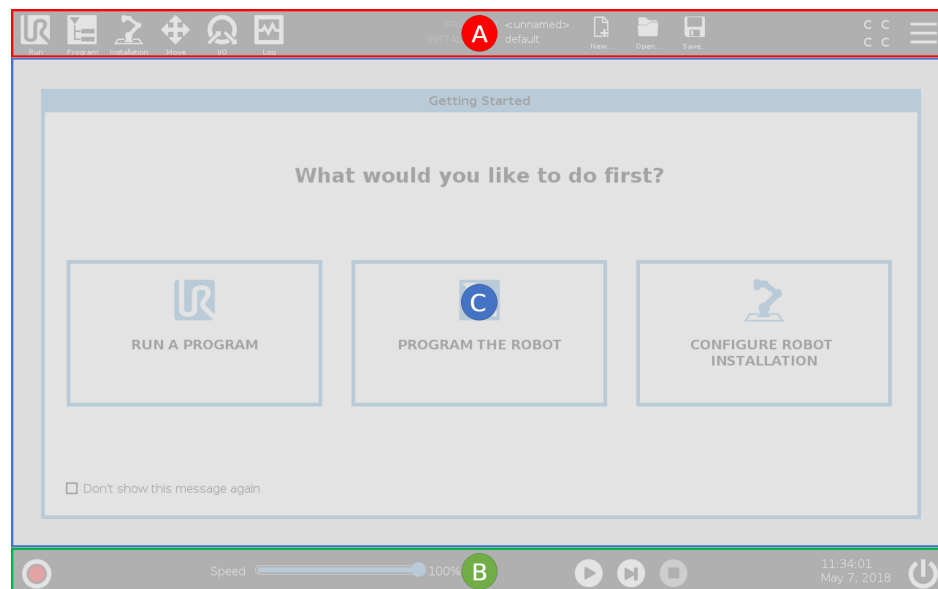

### Using the Touch Screen

The touch sensitivity is designed to avoid false selections on PolyScope, and to prevent unexpected motion of the robot.

The Teach Pendant touch screen is optimized for use in industrial environments. Unlike consumer electronics, Teach Pendant touch screen sensitivity is, by design, more resistant to environmental factors such as:

- water droplets and/or machine coolant droplets
- radio wave emissions
- other conducted noise from the operating environment.

For best results, use the tip of your finger to make a selection on the screen.

In this manual, this is referred to as a "tap".

A commercially available stylus may be used to make selections on the screen if desired.

## Icons/Tabs On PolyScope

**Description** The following section lists and defines the icons/tabs and buttons in the PolyScope interface.

**Header Icons / Functions**

 **Run** is a simple means of operating the robot using pre-written programs.

 **Program** creates and/or modifies robot programs.

 **Installation** configures robot arm settings and external equipment e.g. mounting and safety.

 **Move** controls and/or regulates robot movement.

 **I/O** monitors and sets live Input/Output signals to and from robot control box.

 **Log** indicates robot health as well as any warning or error messages.

 **Program and Installation Manager** selects and displays active program and installation. The Program and Installation Manager includes: File Path, New, Open and Save.

 **New...** creates a new Program or Installation.

 **Open...** opens a previously created and saved Program or Installation.

 **Save...** saves a Program, Installation or both at the same time.

### Operational modes



**Automatic** indicates the operational mode of the robot is set to Automatic. Tap it to switch to the Manual operational mode.



**Manual** indicates the operational mode of the robot is set to Manual. Tap it to switch to the Automatic operational mode.

### Remote Control

The Local mode and Remote mode icons only become accessible if you enable Remote Control.



**Local** indicates the robot can be controlled locally. Tap it to switch to Remote control.



**Remote** indicates the robot can be controlled from a remote location. Tap it to switch to Local control.



**Safety Checksum** displays the active safety configuration.



**Hamburger Menu** accesses PolyScope Help, About and Settings.

### Footer Icons / Functions



**Initialize** manages robot state. When RED, press it to make the robot operational.

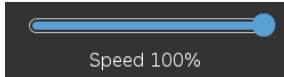

**Speed Slider** shows in real time the relative speed at which the robot arm moves, taking safety settings into account.



**Simulation** button toggles a program execution between Simulation Mode and the Real Robot. When running in Simulation Mode, the Robot Arm does not move. Therefore, the robot cannot damage itself or nearby equipment in a collision. If you are unsure what the Robot Arm will do, use Simulation Mode to test programs.



**Play** starts current loaded robot Program.



**Step** allows a Program to be run single-stepped.



**Stop** halts current loaded robot Program.

**High Speed  
Manual  
Mode**

The High Speed Manual hold-to-run function is only available in manual mode when a Three-Position Enabling Device is configured.



**250mm/s High Speed Manual Mode** allows both tool speed and elbow speed to temporarily exceed 250mm/s.

---

## 4. Safety

---

**Description** Read the safety information here to understand key safety guidelines, important safety messages and your responsibilities when working with the robot. System design and installation are not covered here.

---

### 4.1. General

---

**Description** Read the general safety information and the instructions and guidance pertaining to risk assessment and the intended use. Subsequent sections describe and define safety-related functions particularly relevant for collaborative applications. Read and understand the specific engineering data relevant to mounting and installation, in order to understand the integration of UR robots before the robot is powered on for the first time.

It is essential to observe and follow all assembly instructions in the following sections of this manual.



#### NOTICE

Universal Robots disclaims any and all liability if the robot (arm Control Box with or without Teach Pendant) is damaged, changed or modified in any way. Universal Robots cannot be held responsible for any damages caused to the robot or any other equipment due to programming errors, unauthorized access to the UR robot and its contents, or malfunctioning of the robot.

## 4.2. Safety Message Types

### Description

Safety messages are used to emphasize important information. Read all the messages to help ensure safety and to prevent injury to personnel and product damage.



#### WARNING

Indicates a hazardous situation that, if not avoided, can result in death or serious injury.



#### WARNING: ELECTRICITY

Indicates a hazardous electrical situation that, if not avoided, can result in death or serious injury.



#### WARNING: HOT SURFACE

Indicates a hazardous hot surface where injury can result from contact and non-contact proximity.



#### CAUTION

Indicates a hazardous situation that, if not avoided, can result in injury.



#### GROUND

Indicates grounding.



#### PROTECTIVE GROUND

Indicates protective grounding.



#### NOTICE

Indicates the risk of damage to equipment and/or information to be noted.



#### READ MANUAL

Indicates more detailed information that should be consulted in the manual.

## 4.3. General Warnings and Cautions

**Description** The following warnings messages can be repeated, explained or detailed in subsequent sections.



### WARNING

Failure to adhere to the general safety practices, listed below, can result in injury or death.

- Verify the robot arm and tool/end effector are properly and securely bolted in place.
- Verify the robot application has ample space to operate freely.
- Verify the personnel are protected during the lifetime of the robot application including transport, installation, commissioning, programming/ teaching, operation and use, dismantling and disposing.
- Verify robot safety configuration parameters are set to protect personnel, including those who can be within reach of the robot application.
- Avoid using the robot if it is damaged.
- Avoid wearing loose clothing or jewelry when working with the robot. Tie back long hair.
- Avoid placing any fingers behind the internal cover of the Control Box.
- Inform users of any hazardous situations and the protection that is provided, explain any limitations of the protection and the residual risks.
- Inform users of the location of the emergency stop button(s) and how to activate the emergency stop in case of an emergency or an abnormal situation.
- Warn people to keep outside the reach of the robot, including when the robot application is about to start-up.
- Be aware of robot orientation to understand the direction of movement when using the Teach Pendant.
- Adhere to the requirements in ISO 10218-2.



### WARNING

Handling tools/end effectors with sharp edges and/or pinch points can result in injury.

- Make sure tools/end effectors have no sharp edges or pinch points.
- Protective gloves and/or protective eyeglasses could be required.

**WARNING: HOT SURFACE**

Prolonged contact with the heat generated by the robot arm and the Control Box, during operation, can lead to discomfort resulting in injury.

- Do not handle or touch the robot while in operation or immediately after operation.
- Check the temperature on the log screen before handling or touching the robot.
- Allow the robot to cool down by powering it off and waiting one hour.

**CAUTION**

Failure to perform a risk assessment prior to integration and operation can increase risk of injury.

- Perform a risk assessment and reduce risks prior to operation.
- If determined by the risk assessment, do not enter the range of the robot movement or touch the robot application during operation. Install safeguarding.
- Read the risk assessment information.

**CAUTION**

Using the robot with untested external machinery, or in an untested application, can increase the risk of injury to personnel.

- Test all functions and the robot program separately.
- Read the commissioning information.

**NOTICE**

Very strong magnetic fields can damage the robot.

- Do not expose the robot to permanent magnetic fields.

**READ MANUAL**

Verify all mechanical and electrical equipment is installed according to relevant specifications and warnings.

## 4.4. Integration and Responsibility

---

### Description

The information in this manual does not cover designing, installing, integrating and operating a robot application, nor does it cover all peripheral equipment that can influence the safety of the robot application. The robot application must be designed and installed in accordance with the safety requirements set forth in the relevant standards and regulations of the country where the robot is installed.

The person/s integrating the UR robot are responsible for ensuring that the applicable regulations in the country concerned are observed and that any risks in the robot application are adequately reduced. This includes, but is not limited to:

- Performing a risk assessment for the complete robot system
  - Interfacing other machines and additional safeguarding if required by the risk assessment
  - Setting the correct safety settings in the software
  - Ensuring safety measures are not modified
  - Validating the robot application is designed, and installed and integrated
  - Specifying instructions for use
  - Marking the robot installation with relevant signs and contact information of the integrator
  - Retaining all documentation; including the application risk assessment, this manual and additional relevant documentation.
- 

## 4.5. Stop Categories

---

### Description

Depending on the circumstances, the robot can initiate three types of stop categories defined according to IEC 60204-1. These categories are defined in the following table.

Stop Category	Description
0	Stop the robot by immediate removal of power.
1	Stop the robot in an orderly, controlled manner. Power is removed once the robot is stopped.
2	*Stop the robot with power available to the drives, while maintaining the trajectory. Drive power is maintained after the robot is stopped.

\*Universal Robots robots' Category 2 stops are further described as SS1 or as SS2 type stops according to IEC 61800-5-2.

---

# 5. Lifting and Handling

**Description**

The robot arms come in different sizes and weights, so it is important to use the appropriate lifting and handling techniques for each model. Here you can find information on how to safely lift and handle the robot.

**Proper lifting and handling**

1. Transport the robot to the site using a forklift.
2. Open the box as illustrated.

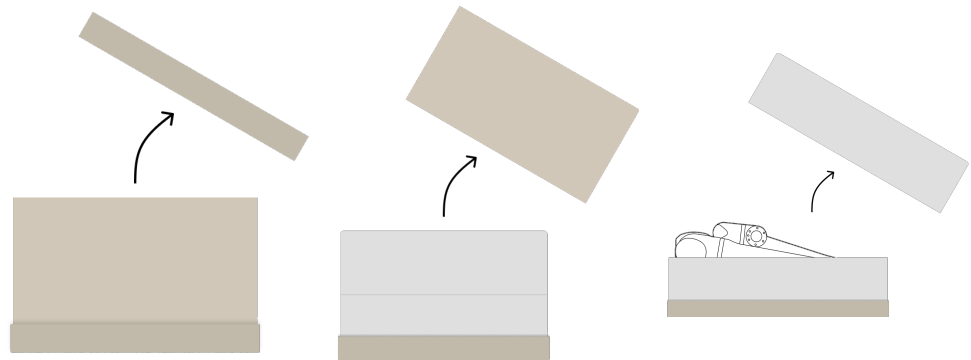

3. Securely strap the robot arm with the lifting sling.

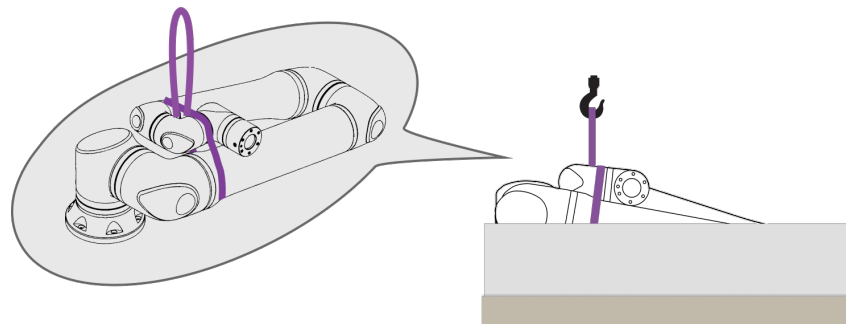

4. Lift the robot arm out of the box using the strap and hook.

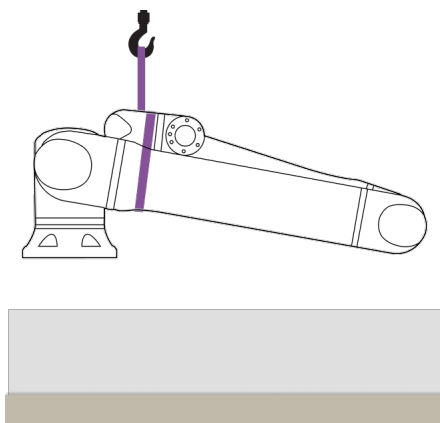

**CAUTION**

Use a lifting equipment when lifting heavier robot arm.

5. While the robot is lifted, support it to rotate and hang as illustrated.

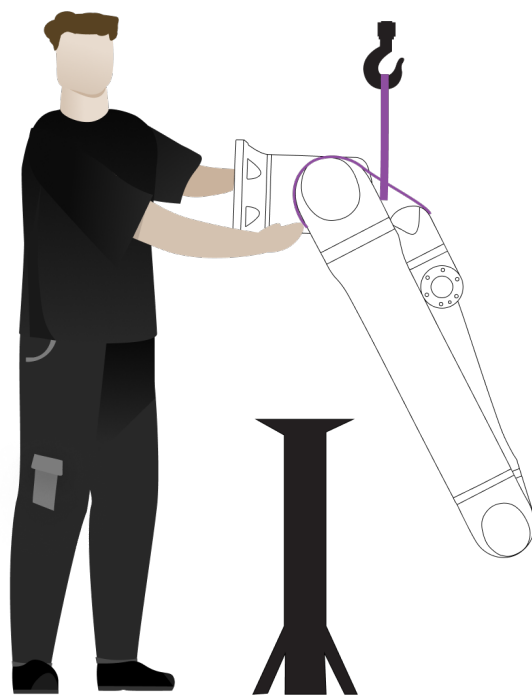

**Mounting  
the Robot  
Arm**

The robot arm can be mounted sideways, upside-down or in an angle ( $\pm 45^\circ$ ).

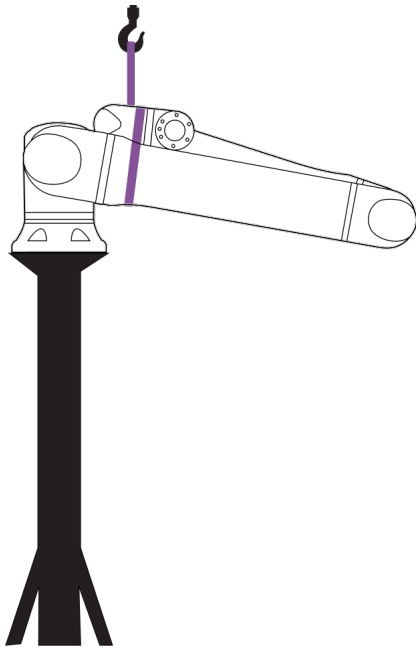

Sideways mounting

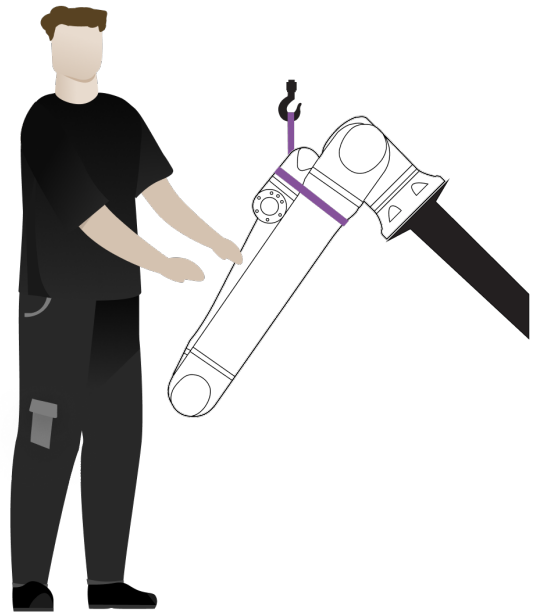

Angular mounting ( $\pm 45^\circ$ )

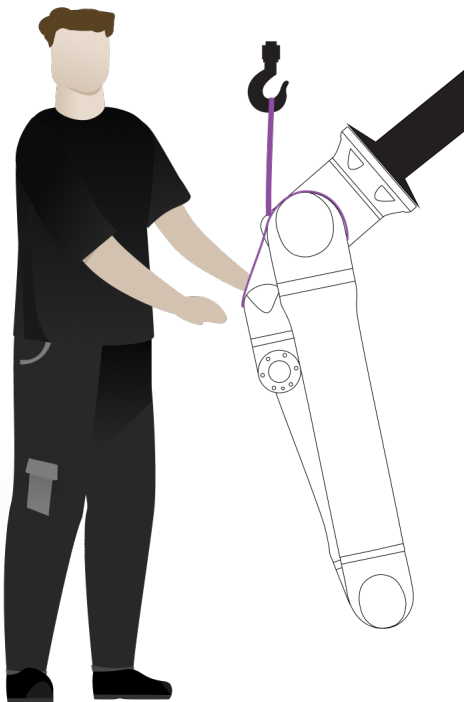

Upside-down mounting

1. Mount the robot arm. Tighten the screws and apply torque as specified in the relevant user manual.

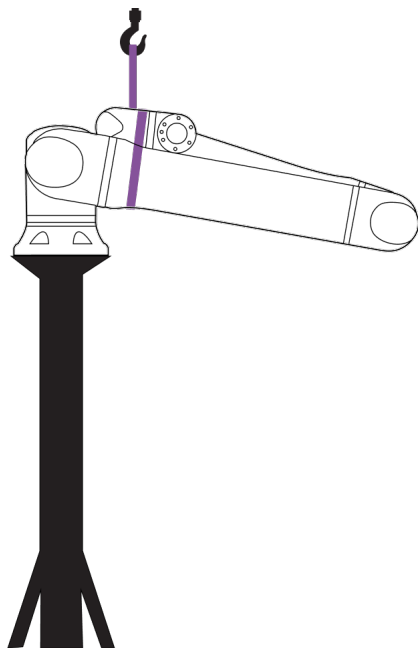

2. Remove the strap.
3. Power on the robot and reposition shoulder joint as intended.

**NOTICE**

For sideways mounting, no need to power on the robot.

4. Re-place the strap.

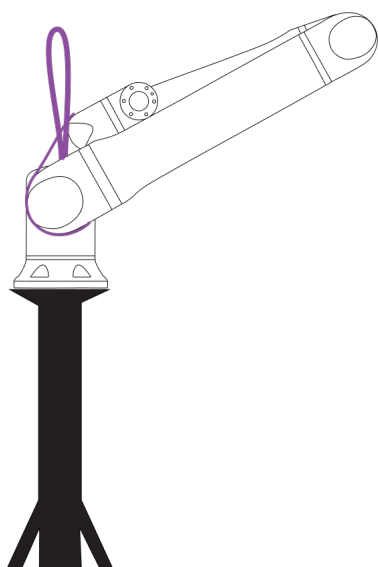



**WARNING**

Lifting or movement of heavy parts can cause injury.

- Lifting apparatus/aid to lift can be required.
- Unpack the robot arm in the desired workspace to minimize lifting and movement of heavy parts.



**WARNING**

Incorrect assembly of components and/or wiring can lead to injury.

- Personal protective gear (footwear, eyewear, gloves) can be required.



**NOTICE**

There may be specific regulations for assembly lifting in your region.

- Follow the local regulations and guidelines for lifting.

For detailed mounting descriptions, see Assembly section.

## 5.1. Robot Arm

**Description**

The robot arm, depending upon weight, can be carried by one or two people unless the sling is provided. If the sling is provided, equipment for lifting and transport is required.

## 5.2. Control Box and Teach Pendant

**Description**

The Control Box and the Teach Pendant can each be carried by one person. While in use, all cables are to be coiled and held to prevent tripping hazards.



# 6. Assembly and Mounting

---

**Description** Install and power on the robot arm and Control Box to start using PolyScope.

---

**Assemble the robot** You have to assemble the robot arm, Control Box and Teach Pendant to be able to continue.

1. Unpack the robot arm and the Control Box.
2. Mount the robot arm on a sturdy, vibration-free surface.
3. Place the Control Box on its Foot.
4. Connect the robot cable to the robot arm and the Control Box.
5. Plug in the mains, or main power cable, of the Control Box.



**WARNING**

Failure to secure the robot arm to a sturdy surface can lead to injury caused by the robot falling.

- Ensure the robot arm is secured to a sturdy surface
-

## 6.1. Securing the Robot Arm

### Description

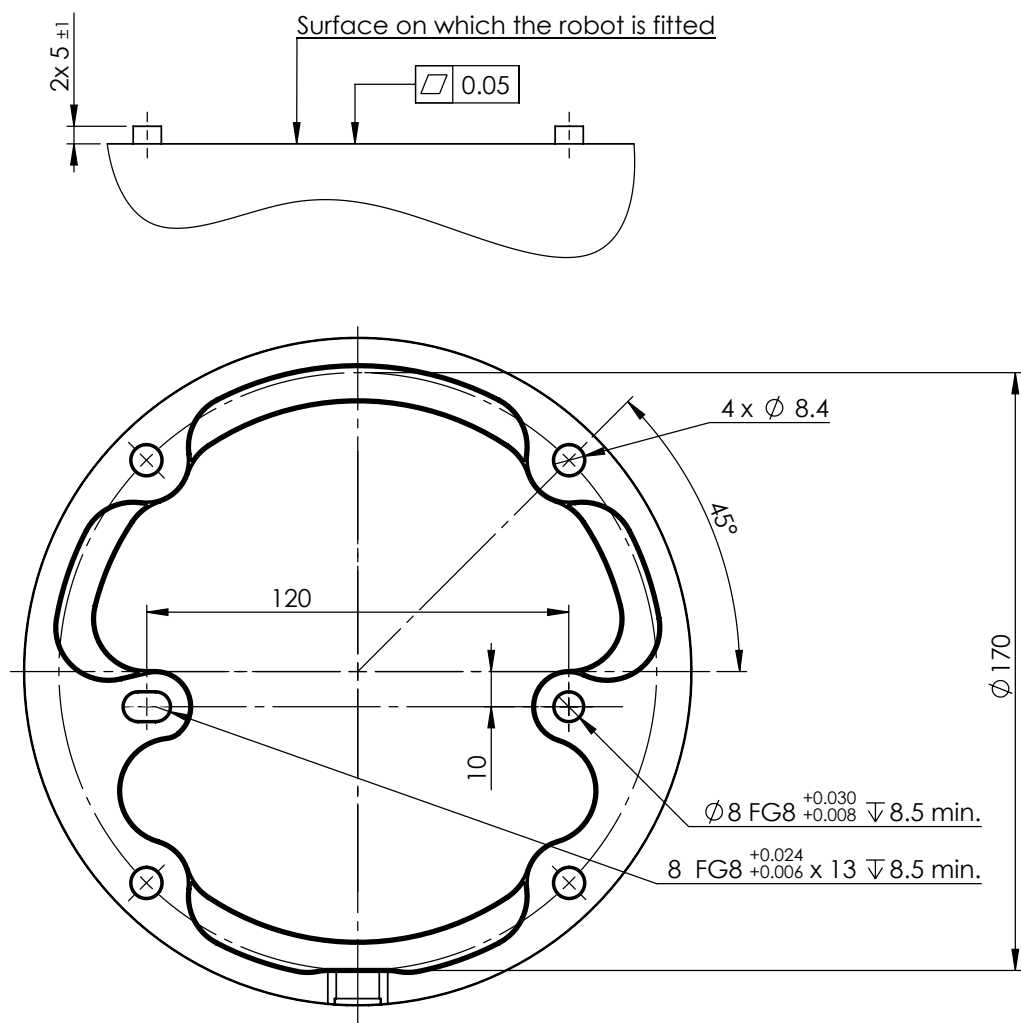

*Dimensions and hole pattern for mounting the robot.*

To power down the robot arm



#### WARNING

Unexpected start-up and/or movement can lead to injury

- Power down the robot arm to prevent unexpected start-up during mounting and dismounting.

1. At the left side of the footer, tap the **Robot State** icon to turn off the robot arm.  
The icon color changes from green to white.
2. Press the power button on the Teach Pendant to turn off the Control Box.
3. If a Shutdown dialog box displays, tap **Power Off**.

At this point, you can continue to:

- Unplug the mains cable / power cord from the wall socket.
- Allow 30 seconds for the robot to discharge any stored energy.

**To secure  
the robot  
arm**

1. Place the robot arm on the surface on which it is to be mounted. The surface must be even and clean.
  2. Tighten the four 8.8 strength, M8 bolts to a torque of 20 Nm.  
(Torque values have been updated SW 5.18. Earlier printed version will show different values)
  3. If accurate re-mounting of the robot is required, use the  $\varnothing 8$  mm. hole and  $\varnothing 8 \times 13$  mm. slot with corresponding ISO 2338  $\varnothing 8$  h6 positioning pins in the mounting plate.
-

## 6.2. Dimensioning the Stand

### Description

The structure (stand) on which the robot arm is mounted is a crucial part of the robot installation. The stand must be sturdy and free of any vibrations from external sources.

Each robot joint produces a torque that moves and stops the robot arm. During normal uninterrupted operation and during stopping motion, the joint torques are transferred to the robot stand as:

- $M_z$ : Torque around the base z axis.
- $F_z$ : Forces along base z axis.
- $M_{xy}$ : Tilting torque in any direction of the base xy plane.
- $F_{xy}$ : Force in any direction in the base xy plane.

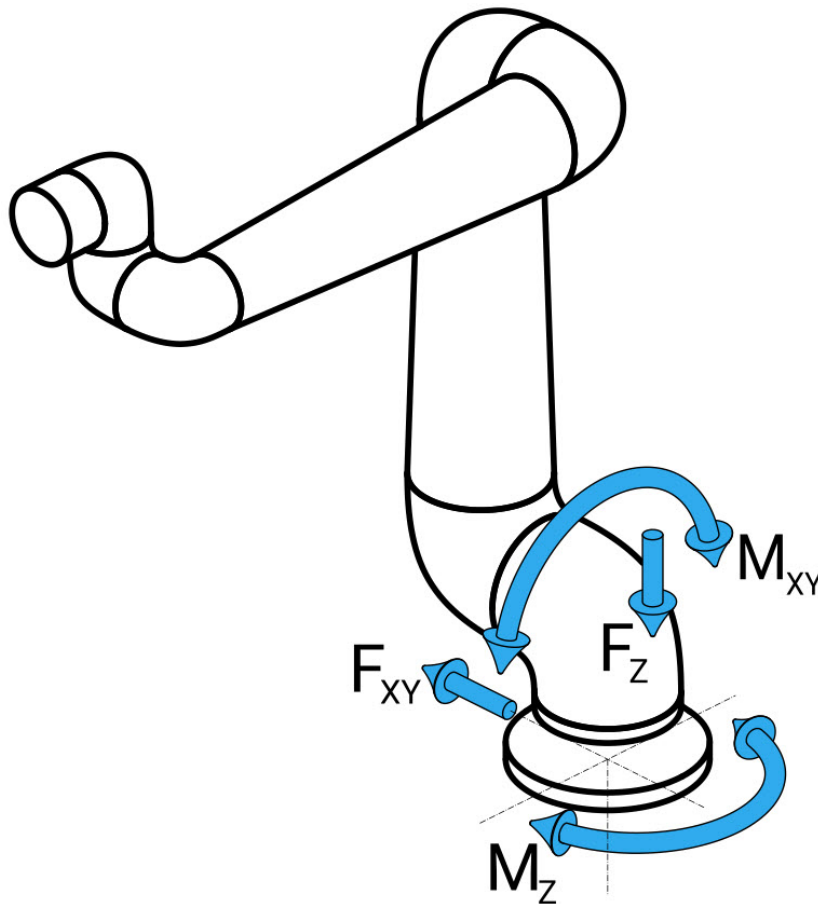

*Force and moment at base flange definition.*

**Dimensioning the Stand** The magnitude of the loads depends on robot model, program and multiple other factors. Dimensioning of the stand shall account for the loads that the robot arm generates during normal uninterrupted operation and during category 0, 1 and 2 stopping motion.

During stopping motion, the joints are allowed to exceed the maximum nominal operating torque. The load during stopping motion is independent of the stop category type. The values stated in the following tables are maximum nominal loads in worst-case movements multiplied with a safety factor of 2.5. The actual loads will not exceed these values.

Robot Model	Mz [Nm]	Fz[N]	Mxy[Nm]	Fxy [N]
UR12e	990	1700	1460	1160

*Maximum joint torques during category 0, 1 and 2 stops.*

Robot Model	Mz [Nm]	Fz[N]	Mxy[Nm]	Fxy [N]
UR12e	830	1450	860	860

*Maximum joint torques during normal operation.*

The normal operating loads can generally be reduced by lowering the acceleration limits of the joints. Actual operating loads are dependent on the application and robot program. You can use URSim to evaluate the expected loads in your specific application.

**Safety margin** You can incorporate added safety margins, factoring in the following design considerations:

**S**

- **Static stiffness:** A stand that is not sufficiently stiff will deflect during robot motion, resulting in the robot arm not hitting the intended waypoint or path. Lack of static stiffness can also result in a poor freedrive teaching experience or protective stops.
- **Dynamic stiffness:** If the frequency of the stand matches the movement frequency of the robot arm, the entire system can resonate, creating the impression that the robot arm is vibrating. Lack of dynamic stiffness can also result in protective stops. The stand should have a minimum resonance frequency of 45 Hz.
- **Fatigue:** The stand shall be dimensioned to match the expected operating lifetime and load cycles of the complete system.



#### WARNING

- Potential for tip-over Hazards.
- The robot arm's operational loads can cause movable platforms, such as tables or mobile robots, to tip over, resulting in possible accidents.
- Prioritize safety by implementing adequate measures to prevent the tipping of movable platforms at all times.



#### CAUTION

- If the robot is mounted on an external axis, the accelerations of this axis must not be too high.

You can let the robot software compensate for the acceleration of external axes by using script command:

```
set_base_acceleration()
```

- High accelerations can cause the robot to make safety stops.

## 6.3. Mounting Description

### Description

Tool Flange	Uses four M6 thread holes for attaching a tool to the tool flange. The M6 strength class 8.8 bolts shall be tightened with 8 Nm. For accurate tool repositioning, use a pin in the Ø6 hole provided.
Control Box	The Control Box can be hung on a wall or placed on the ground.
Teach Pendant	The Teach Pendant is wall mounted or placed onto the Control Box. Verify the cable does not cause tripping hazard. You can buy extra brackets for mounting the Control Box and Teach Pendant.

**WARNING**

Mounting and operating the robot in environments exceeding the recommended IP rating can result in injury.

- Mount the robot in an environment suited to the IP rating. The robot must not be operated in environments that exceed those corresponding to the IP ratings of the robot (IP54), Teach Pendant (IP54) and Control Box (IP44)

**WARNING**

Unstable mounting can result in injury.

- Always make sure the robot parts are properly and securely mounted and bolted in place.

### 6.3.1. Control Box Mounting

---

**To mount a  
CB to a wall**

Use the bracket, shown below, included with the robot to mount the Control Box.  
Mount the bracket to a wall, then hang the Control Box on the bracket via the mounting  
pegs.

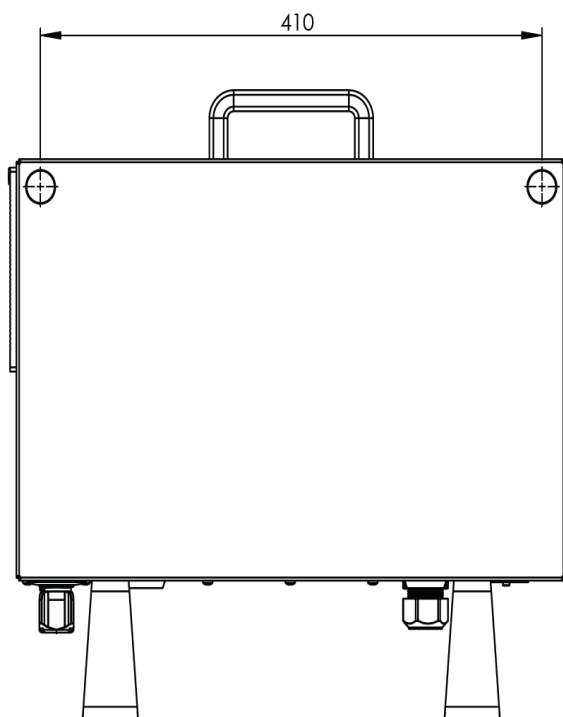

### 6.3.2. Control Box Clearance

**Description** The flow of hot air in the Control Box can result in equipment malfunction. The recommended Control Box clearance is 200 mm on each side for sufficient cool airflow.

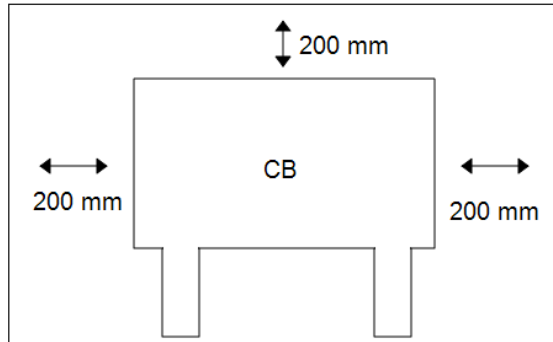

**WARNING**

A wet Control Box can cause fatal injury.

- Make sure the Control Box and cables do not come into contact with liquids.
- Place the Control Box (IP44) in an environment suited for the IP rating.

## 6.4. Workspace and Operating Space

### Description

The workspace is the range of the fully extended robot arm, horizontally and vertically. The operating space is the location where the robot is expected to function.



#### NOTICE

Disregard for the robot workspace and operating space can result in the damage to property.

It is important to consider the cylindrical volume directly above and directly below the robot base when choosing location to mount the robot. Moving the tool close to the cylindrical volume should be avoided because it causes the joints to move fast even when the tool is moving slowly. This can cause the robot to work inefficiently and can make it difficult to conduct a risk assessment.



#### NOTICE

Moving the tool close to the cylindrical volume can cause the joints to move too fast, leading to loss of functionality and damage to property.

- Do not move the tool close to the cylindrical volume, even when the tool is moving slowly.

The cylindrical volume is both directly above and directly below the robot base. The robot extends 1300 mm from the base joint.

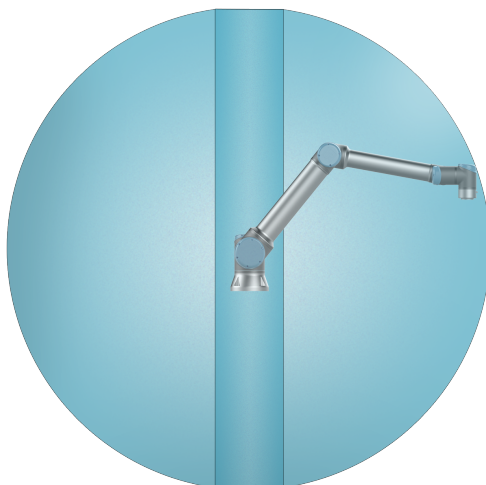

Front

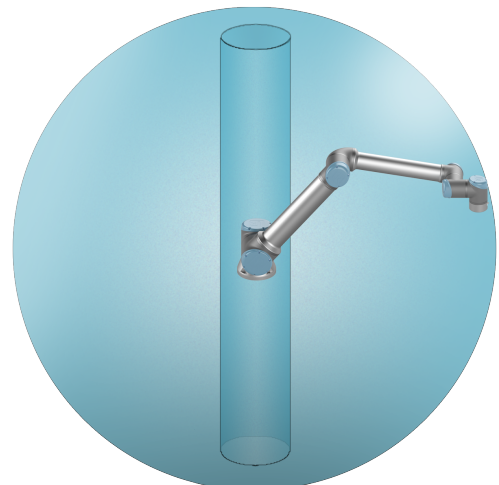

Tilted

## 6.4.1. Singularity

### Description

A singularity is a pose that restricts the motion and the ability to position the robot. The robot arm can stop moving or have very sudden and fast movements when approaching and leaving singularity. During placement of robot in the workspace and definition of the operating space, it is important to take into consideration the singularity position detailed below.



#### WARNING

Make sure that robot motion near a singularity does not create hazards to anyone within the range of the robot arm, end effector, and workpiece.

- Set safety limits for the speed and acceleration of the elbow joint.

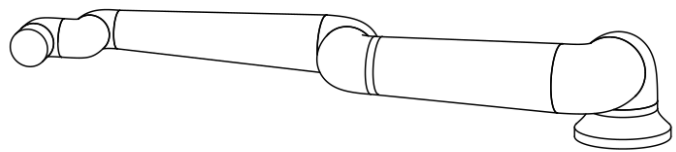
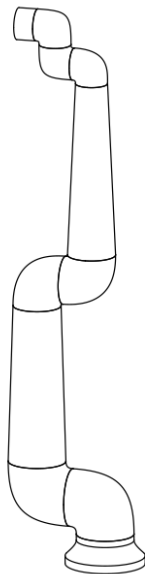

The following causes singularity in the robot arm:

- Outer workspace limit
- Inner workspace limit
- Wrist alignment

### Outer workspace limit

The singularity occurs because the robot cannot reach far enough or it reaches outside of the maximum working area.

To avoid: Arrange the equipment around the robot to avoid it reaching outside of the recommended workspace.

**Inner workspace limit**

The singularity occurs because the movements are directly above or directly below the robot base. This causes many positions/orientations to be unreachable.

To avoid: Program the robot task in such a way that it is not necessary to work in or close to the central cylinder. You can also consider mounting the robot base on a horizontal surface to rotate the central cylinder from a vertical to horizontal orientation, potentially moving it away from the critical areas of the task.

---

**Wrist alignment**

This singularity occurs because wrist joint 2 rotates on the same plane as the shoulder, elbow and wrist joint 1. This limits the range of movement of the robot arm, regardless of workspace.

To avoid: Layout the robot task in such a way that it is not necessary to align the robot wrist joints in this manner. You can also offset the direction of the tool, so that the tool can point horizontally without the problematic wrist alignment.

---

## 6.4.2. Fixed and Movable Installation

---

**Description**

Whether the robot arm is fixed (mounted to a stand, wall or floor) or in a movable installation (linear axis, push cart, or mobile robot base), it must be installed securely to ensure stability through all motions.

The design of the mounting must ensure stability when there are movements of:

- the robot arm
  - the robot base
  - both robot arm and robot base
-

## 6.5. Robot Connections: Base Flange Cable

**Description** This subsection describes the connection for a robot arm configured with a Base Flange Cable connector.

**Base Flange Cable connector** The Base Flange Cable establishes the robot connection to the robot arm to the Control Box. The Robot Cable connects to the Base Flange Cable connector on one end, and to the Control Box connector on the other end. You can lock each connector when robot connection is established.



**CAUTION**

Improper robot connection can result in loss of power to the robot arm.

- Do not use one Robot Cable to extend another Robot Cable.



**NOTICE**

Connecting the Base Flange Cable directly to any Control Box can result in equipment or property damage.

- Do not connect the Base Flange Cable directly to the Control Box.

## 6.6. Robot Connections: Robot Cable

---

**Description** This subsection describes the connection for a robot arm configured with a fixed 6 meter Robot Cable.

---

**To connect the arm and Control box** You can turn the connector to the right to make it easier to lock after the cable is plugged in.

- Establish the robot connection by connecting the robot arm to the Control Box with the Robot Cable.
- Plug and lock the cable from the robot into the connector at the bottom of the Control Box shown below.
- Twist the connector twice to ensure it is properly locked before turning on the robot arm.



### CAUTION

Improper robot connection can result in loss of power to the robot arm.

- Do not disconnect the Robot Cable when the robot arm is turned on.
- Do not modify the original Robot Cable.

## 6.7. Mains Connections

**Description** The mains cable from the Control Box has a standard IEC plug at the end. Connect a country specific mains plug, or cable, to the IEC plug.



**NOTICE**

- IEC 61000-6-4:Chapter 1 scope: “This part of IEC 61000 for emission requirement applies to electrical and electronic equipment intended for use within the environment of existing at industrial (see 3.1.12) locations.”
- IEC 61000-6-4:Chapter 3.1.12 industrial location: “Locations characterized by a separate power network, supplied from a high- or medium-voltage transformer, dedicated for the supply of the installation”

**Mains connections** To power the robot, the Control Box shall be connected to the mains via the supplied power cord. The IEC C13 connector on the power cord connects to the IEC C14 appliance inlet at the bottom of the Control Box.



**WARNING: ELECTRICITY**

Failure to correctly place the mains connection can result in injury.

- The power plug for the mains connection shall be placed outside the reach of the robot, such that power can be removed without exposing personnel to potential hazards.
- If additional safeguarding is implemented, the power plug for the mains connection shall also be placed outside the safeguarded space such that power can be removed without exposure to any potential hazards.



**NOTICE**

Always use a power cord with a country specific wall plug when connecting to the Control Box.

For <200 Vac countries, use power cord with 15A ampacity.

For >200 Vac countries, use power cord with 10A ampacity.

Do not use an adapter.

As a part of the electrical installation, provide the following:

- Connection to ground
- Main fuse
- Residual current device
- A lockable (in the OFF position) switch

A main switch shall be installed to power off all equipment in the robot application as an easy means for lockout. The electrical specifications are shown in the table below.

Parameter	Min	Typ	Max	Unit
Input voltage	90	-	264	VAC
External mains fuse (90-200V)	15	-	16	A
External mains fuse (200-264V)	8	-	16	A
Input frequency	47	-	440	Hz
Stand-by power	-	-	<1.5	W
Standby voltage			5	V
Nominal operating power	90	250	500	W



#### WARNING: ELECTRICITY

Failure to follow any of the below can result in serious injury or death due to electrical hazards.

- Ensure the robot is grounded correctly (electrical connection to ground). Use the unused bolts associated with grounding symbols inside the Control Box to create common grounding of all equipment in the system. The grounding conductor shall have at least the current rating of the highest current in the system.
- Ensure the input power to the Control Box is protected with a Residual Current Device (RCD) and a correct fuse.
- Lockout all power for the complete robot installation during service.
- Ensure other equipment shall not supply power to the robot I/O when the robot is locked out.
- Ensure all cables are connected correctly before the Control Box is powered. Always use the original power cord.

# 7. First Boot

---

- Description** The first boot is the initial sequence of actions you can take to configure the robot for the first time after assembly.
- This initial sequence requires you to:
- Power on the robot
  - Insert the serial number
  - Initialize the robot arm
  - Use Freedrive
  - Power down the robot
- 

**CAUTION**

Failure to verify the payload and installation before starting up the robot arm can lead to injury to personnel and/or property damage.

- Always verify the actual payload and installation are correct before starting up the robot arm.

**CAUTION**

Incorrect payload and installation settings prevent the robot arm and Control Box functioning correctly.

- Always verify the payload and installation setting are correct.

**NOTICE**

Starting up the robot in lower temperatures can result in lower performance, or stops, due to temperature dependent oil and grease viscosity.

- Starting up the robot in low temperatures can require a warmup phase.
-

## 7.1. Powering On the Robot

---

**To power on the robot**

Powering on the robot turns on the Control Box and loads the display on the TP screen.

1. Press the power button on the Teach Pendant to power on the robot.
- 

## 7.2. Inserting the Serial Number

---

**To insert the serial number**

Installing your robot for the first time requires you to enter the serial number on the robot arm. This procedure is also required when you re-install the software. For example, when you install a software update.

1. Select your Control Box.
2. Add the serial number as it is written on the robot arm.
3. Tap **OK** to end.

It can take a few minutes for the start screen to load.

---

## 7.3. Confirming the Safety Configuration

---

### To confirm the safety configuration

On your first start up, you need to confirm the robot's safety configuration.

1. Tap Confirm Safety Configuration to confirm the safety configuration.
- 

## 7.4. Starting the Robot Arm

---

### To start the robot

Starting the robot arm disengages the braking system, allowing you to start moving the robot arm and to start using PolyScope.

You can follow the progression as the circles in the Initialize box change color.

The Initialize button in the Footer also changes color depending on the status of the robot arm.

1. At the bottom left of the screen, in the Footer, tap the red Initialize button.

The initialization starts. A yellow circle displays **Robot Active**.

This means the joint brakes are unreleased and the robot arm cannot be moved.

2. Tap **START** to release the breaks in the robot arm.

The initialization continues as the green circles consecutively display **Robot in Robot Active**, then **Brakes Released**.

Sound and slight movements accompany the joint brakes being released.

3. Tap **Exit** to remove the Initialize box.

At this point the green circle displays Robot in Normal Mode.

If the robot arm mounting is verified, you can tap **START** to continue releasing all the joint brakes, preparing the robot arm for operation.

The Getting Started screen can be displayed, prompting you to begin programming the robot.

**NOTICE**

The first time you initialize the robot arm, a Cannot Proceed dialog box can appear.

Select Go to initialization screen to access the Initialize screen.

In the Footer, to the left, the Initialize button indicates the status of the robot arm using colors:

- **Red** Power off. The robot arm is in a stopped state.
- **Yellow** Idle. The robot arm is on, but not ready for normal operation.
- **Green** Normal. The robot arm is on and ready for normal operation.

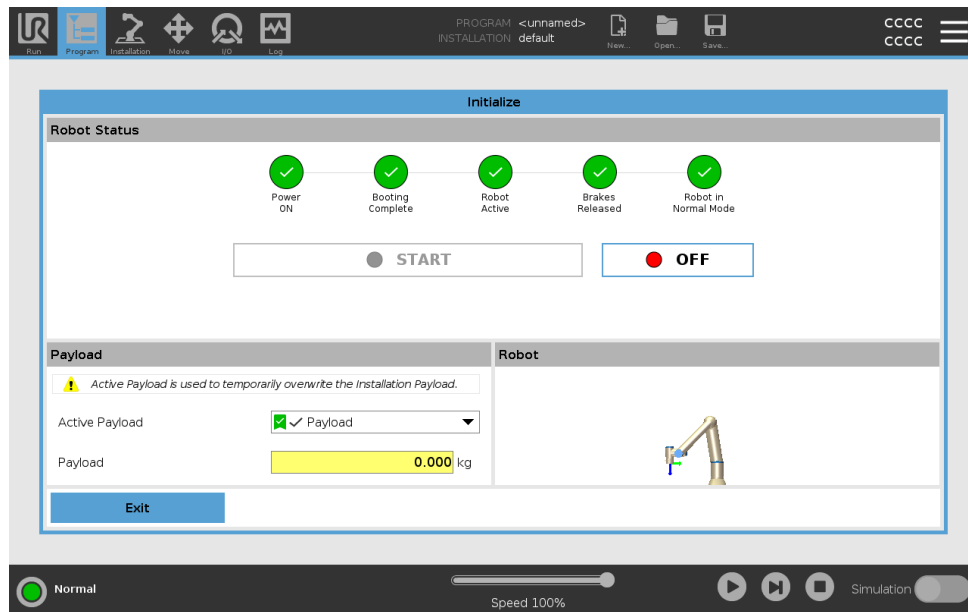

## 7.5. Verifying the Robot Arm Mount

**To verify the mounting**

During the first start up, you may need to verify how the robot arm is mounted. If the robot arm is mounted on a flat table or floor, no change is needed. If the mounting of the robot arm is not verified, the Getting Started dialog box appears.

1. Tap **Configure Robot Installation**
2. Under General, tap **Mounting** to display the Robot Mounting and Angle screen.
3. Use the buttons to the right of the screen to adjust the angles of the robot arm. The robot arm can power off to apply your changes.
4. Repeat the Start up and the Initialize sequences previously described.

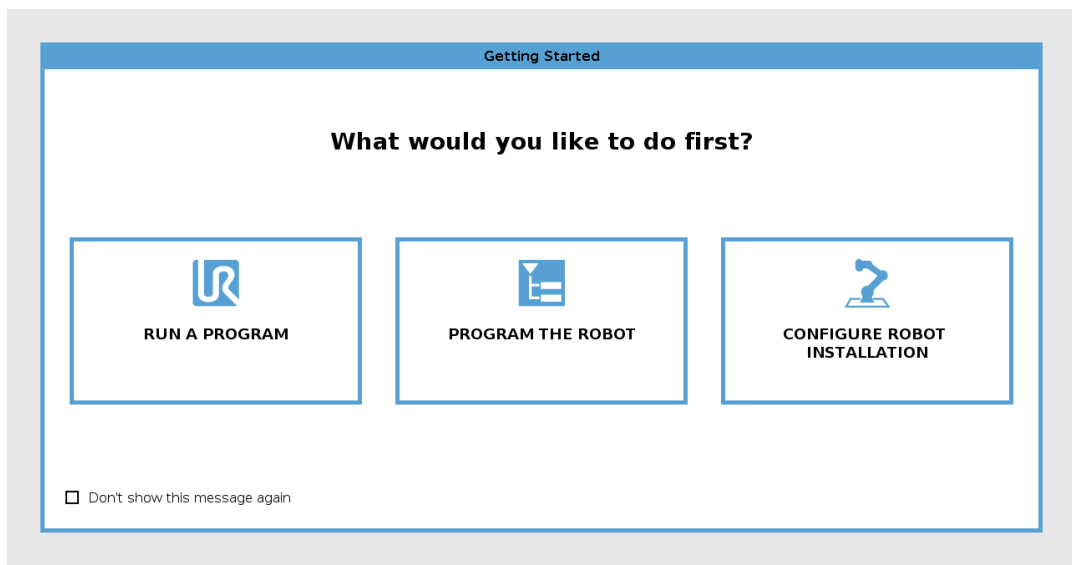

Copyright © 2009-2025 by Universal Robots A/S. All rights reserved.

## 7.6. Adjusting the Robot Arm Mount

**Description**

Specifying the mounting of the robot arm serves two purposes:

1. To make the robot arm appear correctly on the PolyScope screen.
2. To tell the controller about the direction of gravity.



**WARNING**

Failure to mount the robot arm correctly can result in frequent stops.



**WARNING**

Verify and use the correct installation settings. Save and load the installation files with the program.

If the robot arm is mounted in one of the ways listed below, adjustment is required.

- ceiling mounted
- wall mounted
- mounted at an angle

On the Robot Mounting and Angle screen, use the buttons on the right to set the angle of the robot arm mounting. The first three buttons set the angle as follows:

- ceiling (180°)
- wall (90°)
- floor (0°)

The Tilt buttons set an arbitrary angle.

Use the buttons on the lower part of the screen to rotate the mounting of the Robot arm to match the actual mounting.

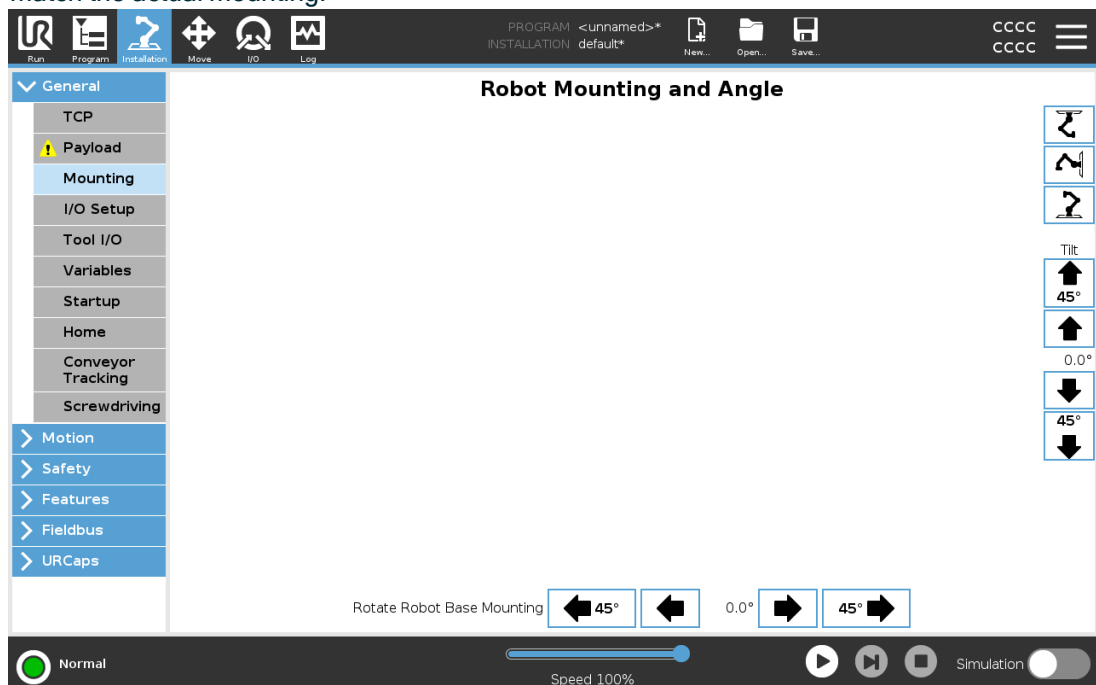

An advanced dynamics model gives the robot arm smooth and precise motions and allows the robot arm to hold itself in Freedrive. For this reason, it is important to mount the robot arm correctly.

## 7.7. Freedrive

---

### Description

Freedrive allows the robot arm to be manually pulled into desired positions. For most robot sizes, the most typical way to enable Freedrive is to press the Freedrive button on the Teach Pendant. More ways to enable and use Freedrive are described in the following sections.

In Freedrive, the robot arm joints move with little resistance because the brakes are released. Resistance increases as the robot arm in Freedrive approaches a predefined limit or plane. This makes pulling the robot into position feel heavy.



#### WARNING

Injury to personnel can occur due to unexpected motion.

- Verify the configured payload is the payload being used.
- Verify the correct payload is securely attached to the tool flange.

### Enabling Freedrive

You can enable Freedrive in the following ways:

- Use the 3PE Teach Pendant.
- Use the Freedrive on robot.
- Use I/O Actions.



#### NOTICE

Enabling Freedrive while you are moving the robot arm, can cause it to drift leading to faults.

- Do not enable Freedrive while you are pushing or touching the robot.

### 3PE Teach Pendant

To use the 3PE TP button to freedrive the robot arm:

1. Rapidly light-press, release, light-press again and keep holding the 3PE button in this position.

Now you can pull the robot arm into a desired position, while the light-press is maintained.

---

**Freedrive on robot**

To use Freedrive on robot to freedrive the robot arm:

1. Press-and-hold the button of switch configured for **Freedrive on robot**.
2. When the Freedrive panel appears in PolyScope, select the desired movement type for the robot arm's joints. Or use the list of axes to customize the movement type.
3. You can define the type of feature if required, by selecting an option from the Feature dropdown list.  
  
The robot arm can stop moving if it approaches a singularity scenario. Tap **All axes are free** in the Freedrive panel to resume movement.
4. Move the robot arm as desired.

**Backdrive**

During initialization of the robot arm, minor vibrations may be observed when the robot brakes are released. In some situations, such as when the robot is close to collision, these vibrations are undesirable. Use Backdrive to force specific joints to a desired position without releasing all brakes in the robot arm.

## 7.7.1. Freedrive Panel

**Description** When the robot arm is in Freedrive, a panel appears on PolyScope, as illustrated below.

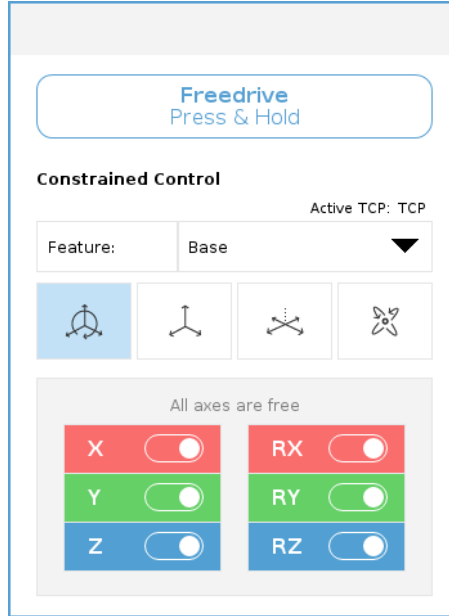

### To access the Freedrive Panel

1. In the Header, tap the Move tab.
2. At the bottom of the screen, tap Freedrive.  
The Freedrive Panel opens.
3. Press and hold the Freedrive button inside the Panel.

You can the robot arm manually, similar to pressing the Freedrive button located on the Teach Pendant.

A LED indicates when the robot arm approaches a singularity position. The LED is detailed in the following section.





### LED in Freedrive panel

The LED on the status bar of the Freedrive panel indicates:

- When one or more joints are approaching their joint limits.
- When the robot arm's positioning is approaching singularity. Resistance increases as the robot approaches singularity, making it feel heavy to position.

### Freedrive Panel icons

You can lock one or more of the axes allowing the TCP to move in a particular direction, as defined in the table below.

 All axes are free	Movement is allowed through all axes.
 Plane	Movement is only allowed through the X-axis and Y-axis.
 Translation	Movement is allowed through all axes, without rotation.
 Rotation	Movement is allowed through all axes, in a spherical motion, around the TCP.

**CAUTION**

Moving the robot arm in some axes when a tool is attached, can present a pinch point.

- Use caution when moving the robot arm in any axis.

## 7.8. Power Down The Robot

To power down the robot arm

**WARNING**

Unexpected start-up and/or movement can lead to injury

- Power down the robot arm to prevent unexpected start-up during mounting and dismounting.

1. At the left side of the footer, tap the **Robot State** icon to turn off the robot arm.  
The icon color changes from green to white.
2. Press the power button on the Teach Pendant to turn off the Control Box.
3. If a Shutdown dialog box displays, tap **Power Off**.

At this point, you can continue to:

- Unplug the mains cable / power cord from the wall socket.
- Allow 30 seconds for the robot to discharge any stored energy.

# 8. Installation

**Description** Installing the robot can require the configuration and use of input and output signals (I/Os). These different types of I/Os and their uses are described in the following sections.

## 8.1. Electrical Warnings and Cautions

**Warnings** Observe the following warnings for all the interface groups, including when you design and install an application.



### WARNING

Failure to follow any of the below can result in serious injury or death, as the safety functions could be overridden.

- Never connect safety signals to a PLC that is not a safety PLC with the correct safety level. It is important to keep safety interface signals separated from the normal I/O interface signals.
- All safety-related signals shall be constructed redundantly (two independent channels).
- Keep the two independent channels separate so a single fault cannot lead to loss of the safety function.



### WARNING: ELECTRICITY

Failure to follow any of the below can result in serious injury or death due to electrical hazards.

- Make sure all equipment not rated for water exposure remain dry. If water is allowed to enter the product, lockout-tagout all power and then contact your local Universal Robots service provider for assistance.
- Only use the original cables supplied with the robot only. Do not use the robot for applications where the cables are subject to flexing.
- Use caution when installing interface cables to the robot I/O. The metal plate in the bottom is intended for interface cables and connectors. Remove the plate before drilling holes. Make sure that all shavings are removed before reinstalling the plate. Remember to use correct gland sizes.

**CAUTION**

Disturbing signals with levels higher than those defined in the specific IEC standards can cause unexpected behaviors from the robot. Be aware of the following:

- The robot has been tested according to international IEC standards for **ElectroMagnetic Compatibility (EMC)**. Very high signal levels or excessive exposure can damage the robot permanently. EMC problems are found to happen usually in welding processes and are normally prompted by error messages in the log. Universal Robots cannot be held responsible for any damages caused by EMC problems.
- I/O cables going from the Control Box to other machinery and factory equipment may not be longer than 30m, unless additional tests are performed.

**GROUND**

Negative connections are referred to as Ground (GND) and are connected to the casing of the robot and the Control Box. All mentioned GND connections are only for powering and signalling. For PE (Protective Earth) use the M6-size screw connections marked with earth symbols inside the Control Box. The grounding conductor shall have at least the current rating of the highest current in the system.

**READ MANUAL**

Some I/Os inside the Control Box can be configured for either normal or safety-related I/O. Read and understand the complete Electrical Interface chapter.

## 8.2. Control Box Connection Ports

### Description

The underside of the I/O interface groups in the Control Box is equipped with external connection ports and a fuse, described below. There are capped openings at the base of the Control Box cabinet to run external connector cables to access the connection ports.

### External connection ports

The ports for external connections are as follows:

- Teach Pendant port to use the Teach Pendant to control or program the robot arm.
- SD card port to insert an SD card.
- Ethernet port to allow ethernet type connections.
- Mini DisplayPort to support monitors using DisplayPort. This port requires an active converter to support DVI or HDMI.
- The Mini Blade Fuse is used when an external power supply is connected.

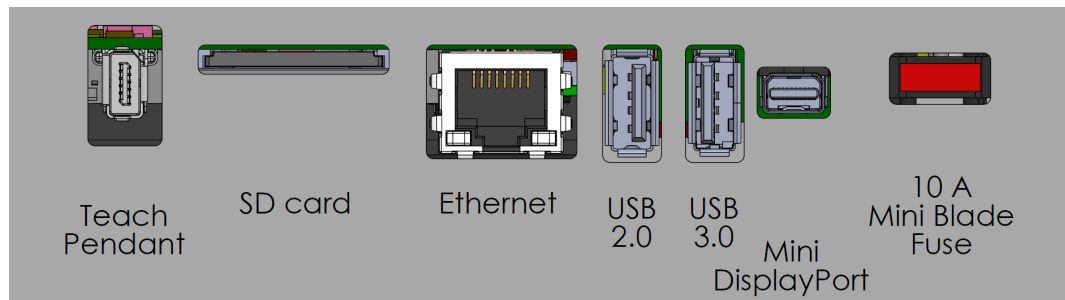

#### NOTICE

Connecting or disconnecting a Teach Pendant while the Control Box is powered on can cause equipment damage .

- Do not connect a Teach Pendant while the Control Box is on.
- Power off the Control Box before you connect a Teach Pendant.



#### NOTICE

Failure to plug in the active adapter before powering on the Control Box can hinder the display output.

- Plug in the active adapter before powering on the Control Box.
- In some cases the external monitor must be powered on before the Control Box.
- Use an active adapter that supports revision 1.2 as not all adapters function out-of-the-box.

## 8.3. Ethernet

---

- Description** The Ethernet interface can be used for:
- MODBUS, EtherNet/IP and PROFINET.
  - Remote access and control.
- 

To connect the Ethernet cable by passing it through the hole at the base of the Control Box, and plugging it into the Ethernet port on the underside of the bracket. Replace the cap at the base of the Control Box with an appropriate cable gland to connect the cable to the Ethernet port.

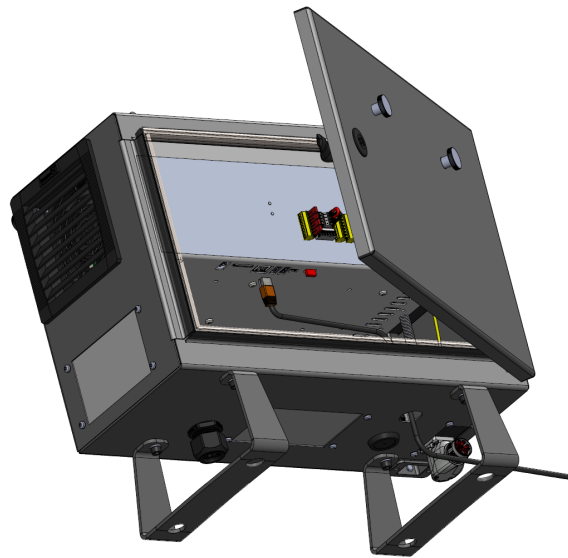

The electrical specifications are shown in the table below.

Parameter	Min	Typ	Max	Unit
Communication speed	10	-	1000	Mb/s

---

## 8.4. 3PE Teach Pendant Installation

**Description** The 3-Position Enabling Teach Pendant (3PE TP) is a safety-critical interface designed to enhance manual control. Integrated directly into the Teach Pendant, the 3PE buttons ensures that robot motion can only be initiated when the operator maintains a controlled grip.

### 8.4.1. Hardware Installation

#### To remove a Teach Pendant



**NOTICE**

Replacing the Teach Pendant can result in the system reporting a fault on start-up.

- Always select the correct configuration for the type of Teach Pendant.

To remove the standard Teach Pendant:

1. Power down the control box and disconnect the main power cable from the power source.
2. Remove and discard the two cable ties used for mounting the Teach Pendant cables.
3. Press in the clips on both sides of the Teach Pendant plug as illustrated, and pull down to disconnect from the Teach Pendant port.
4. Fully open/loosen the plastic grommet at the bottom of the control box and remove the Teach Pendant plug and cable.
5. Gently remove the Teach Pendant cable and Teach Pendant.

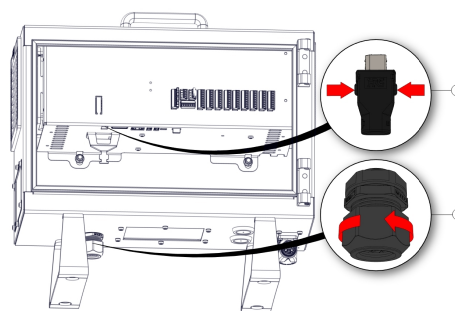

1 Clips

2 Plastic grommet

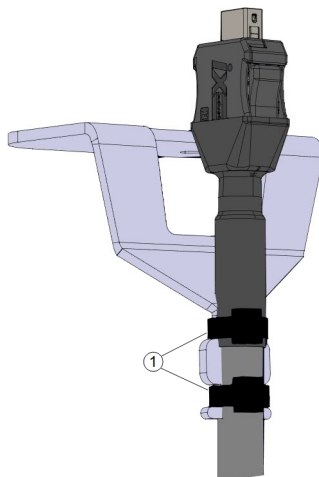

1	Cable ties
---	------------

### To install a 3PE Teach Pendant

1. Place the Teach Pendant plug and cable in through the bottom of the control box and fully close/tighten the plastic grommet.
2. Push the Teach Pendant plug into the Teach Pendant port to connect.
3. Use two new cable ties to mount the Teach Pendant cables.
4. Connect the main power cable to the power source and power on the control box.

There is always a length of cable with the Teach Pendant that can present a tripping hazard if it is not stored properly.

- Always store the Teach Pendant and the cable properly to avoid tripping hazards.

## 8.5. Controller I/O

**Description** The electrical interface inside the Control Box consists of groups Inputs and Outputs I/O that allow for communication and configurations between the robot arm and different types of equipment. The I/O groups include:

- Digital (24V)
- Configurable (24V)
- Analog
- Safety (24V)

The illustration below shows the layout of electrical interface groups inside the Control Box. Observe and maintain the purpose of the color scheme, as illustrated below.

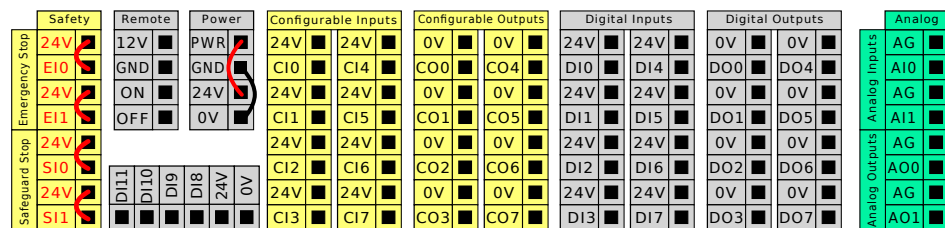

Yellow with red text	Dedicated safety signals
Yellow with black text	Configurable for safety
Gray with black text	General purpose digital I/O
Green with black text	General purpose analog I/O

**I/O groups** You can install the robot according to the electrical specifications which are the same for all three listed inputs.

- Safety I/O.
- Configurable I/O.
- General purpose I/O.



**NOTICE**

Configurable I/O are I/O configured as either safety-related I/O or normal I/O. These are the yellow terminals with black text.

It is possible to power the digital I/O from an internal 24V power supply or from an external power source by configuring the terminal block called **Power**. This block consists of four terminals. The upper two (PWR and GND) are 24V and ground from the internal 24V supply. The lower two terminals (24V and 0V) in the block are the 24V input to supply the I/O. The default configuration uses the internal power supply.

**Power supply default**

In this example the default configuration uses the internal power supply

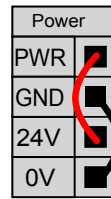

**External power supply**

If more current is needed, you can connect an external power supply as shown below. The fuse is Mini Blade type with maximum current rating of 10 A and a minimum voltage rating of 32 V. The fuse must be UL marked. If the fuse is overloaded, it must be replaced.

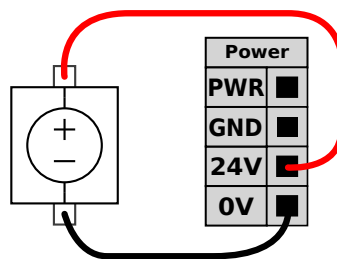

In this example the configuration uses an external power supply for more current.

**Power supply specification**

The electrical specifications for both the internal and external power supply are shown below.

Terminals	Parameter	Min	Typ	Max	Unit
<i>Internal 24V power supply</i>					
[ PWR - GND ]	Voltage	23	24	25	V
[ PWR - GND ]	Current	0	-	2*	A
<i>External 24V input requirements</i>					
[ 24V - 0V ]	Voltage	20	24	29	V
[ 24V - 0V ]	Current	0	-	6	A

\*3.5A for 500ms or 33% duty cycle.

Copyright © 2009-2025 by Universal Robots A/S. All rights reserved.

**Digital I/O specification** The digital I/O are constructed in compliance with IEC 61131-2. The electrical specifications are shown below.

Terminals	Parameter	Min	Typ	Max	Unit
<b>Digital Outputs</b>					
[CO <sub>x</sub> / DO <sub>x</sub> ]	Current*	0	-	1	A
[CO <sub>x</sub> / DO <sub>x</sub> ]	Voltage drop	0	-	0.5	V
[CO <sub>x</sub> / DO <sub>x</sub> ]	Leakage current	0	-	0.1	mA
[CO <sub>x</sub> / DO <sub>x</sub> ]	Function	-	PNP	-	Type
[CO <sub>x</sub> / DO <sub>x</sub> ]	IEC 61131-2	-	1A	-	Type
<b>Digital Inputs</b>					
[EI <sub>x</sub> /SI <sub>x</sub> /CI <sub>x</sub> /DI <sub>x</sub> ]	Voltage	-3	-	30	V
[EI <sub>x</sub> /SI <sub>x</sub> /CI <sub>x</sub> /DI <sub>x</sub> ]	OFF region	-3	-	5	V
[EI <sub>x</sub> /SI <sub>x</sub> /CI <sub>x</sub> /DI <sub>x</sub> ]	ON region	11	-	30	V
[EI <sub>x</sub> /SI <sub>x</sub> /CI <sub>x</sub> /DI <sub>x</sub> ]	Current (11-30V)	2	-	15	mA
[EI <sub>x</sub> /SI <sub>x</sub> /CI <sub>x</sub> /DI <sub>x</sub> ]	Function	-	PNP +	-	Type
[EI <sub>x</sub> /SI <sub>x</sub> /CI <sub>x</sub> /DI <sub>x</sub> ]	IEC 61131-2	-	3	-	Type

\*For resistive loads or inductive loads of maximum 1H.

## 8.5.1. Digital Input and Output

**Digital Output** The tool communication interface allows two digital outputs to be independently configured. In PolyScope, each pin has a drop-down menu that allows the output mode to be set. The following options are available:

- **Sinking:** This allows the pin to be configured in an NPN or Sinking configuration. When the output is off, the pin allows a current to flow to the ground. This can be used in conjunction with the PWR pin to create a full circuit.
- **Sourcing:** This allows the pin to be configured in a PNP or Sourcing configuration. When the output is on, the pin provides a positive voltage source (configurable in the IO Tab). This can be used in conjunction with the GND pin to create a full circuit.
- **Push / Pull:** This allows the pin to be configured in a Push / Pull configuration. When the output is on, the pin provides a positive voltage source (configurable in IO Tab). This can be used in conjunction with the GND pin to create a full circuit. When the output is off, the pin allows a current to flow to the ground.

After selecting a new output configuration, the changes take effect. The currently loaded installation is modified to reflect the new configuration. After verifying the tool outputs are working as intended, make sure to save the installation to prevent losing changes.

**Digital Input** You can use the horizontal Digital Inputs block (DI8-DI11), illustrated below, for quadrature encoding Conveyor Tracking.

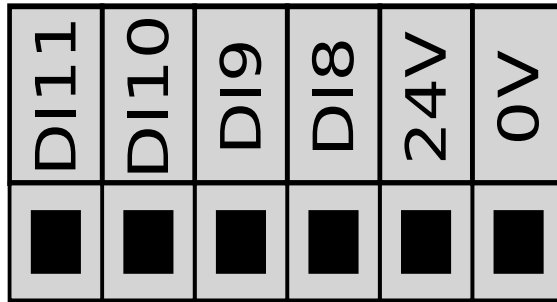

### 8.5.2. I/O Interface Control

**Description** The I/O Interface Control allows you to switch between user control and URcap control.

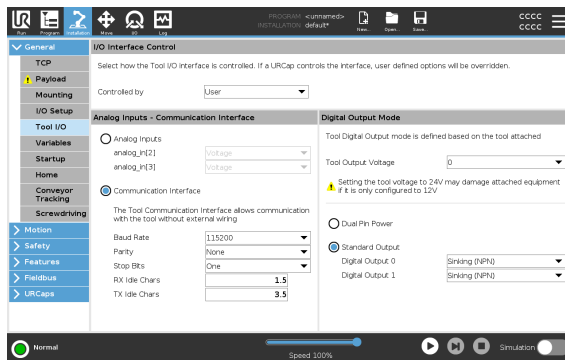

**to use the I/O Interface Control**

1. Tap the Installation tab and under General, tap Tool I/O
2. Under I/O Interface Control, select User to access the Tool Analog Inputs and/or Digital Output Mode settings. Selecting a URcap removes access to the Tool Analog Inputs and the Digital Output Mode settings.



**NOTICE**

If a URcap controls an end-effector, such as a gripper, then the URcap requires control of the Tool IO Interface. Select the URcap in the list, to allow it to control the Tool IO Interface.

### 8.5.3. Using the I/O Tab

**Description** Use the I/O Tab screen to monitor and set the live I/O signals from/to the Control Box.

The screen displays the current state of the I/O, including during program execution. The program stops if anything is changed during execution. At program stop, all output signals retain their states. The screen updates at 10Hz, so a very fast signal might not display properly.

Configurable I/Os can be reserved for special safety settings defined in the safety I/O configuration section of the installation (see I/O); those which are reserved will have the name of the safety function in place of the default or user defined name. Configurable outputs that are reserved for safety settings are not togglable and will be displayed as LED's only.

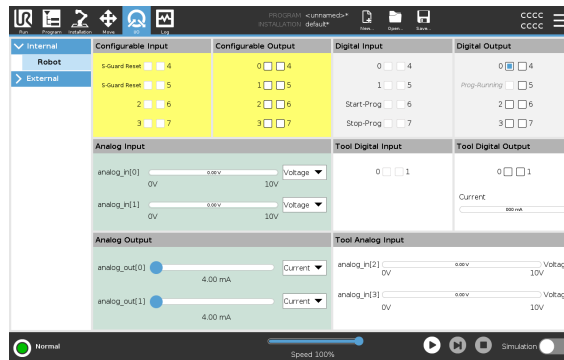

**Voltage** When the Tool Output is controlled by the user, you can configure Voltage. Selecting a URCap removes access to Voltage.

**Analog Domain Settings** The analog I/O's can be set to either current [4-20mA] or voltage [0-10V] output. These settings are persistent over restarts of the robot controller and saved in the installation. Control over the tool I/Os could be assigned to a URCap in **Tool I/O** of the **Installation** tab. Selecting a URCap removes user's control over tool's analog I/O.

**Tool Communication Interface** When the **Tool Communication Interface TCI** is enabled, the tool analog input becomes unavailable. On the I/O screen, the **Tool Input** field appears as shown.

Tool Analog Input	
Baud Rate	115200
Parity	None
Stop Bits	One
RX Idle Chars	1.50
TX Idle Chars	3.50

**Dual Pin power**

Dual Pin Power is used as a source of power for the tool. Enabling Dual Pin Power disables the default tool digital outputs. When Dual Pin Power is enabled, the tool digital outputs shall be named as follows:

- tool\_out[0] (Power)
- tool\_out[1] (GND)

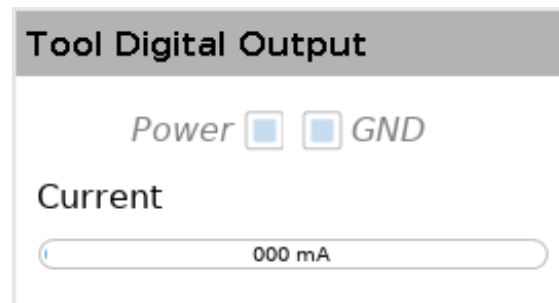

## 8.5.4. Drive Power Indicator

---

**Description**

The drive power indicator is a light that turns on when the robot arm is powered on, or when there is power to the robot cable. When the robot arm is powered off, the drive power indicator turns off.

The drive power indicator is connected via the Digital Outputs. It is not a safety feature and does not use safety I/Os.

---

**Indicator**

The drive power indicator can be a light that can work at 24VDC.

---

## 8.6. Safety I/O

**Safety I/O** This section describes dedicated safety input (Yellow terminal with red text) and configurable I/O (Yellow terminals with black text) when configured as safety I/O. Safety devices and equipment must be installed according to the safety instructions and the risk assessment in chapter Safety. All safety I/O are paired (redundant), so a single fault does not cause loss of the safety function. However, the safety I/O must be kept as two separate branches.

The permanent safety input types are:

- **Robot Emergency Stop** for emergency stop equipment only
- **Safeguard Stop** for protective devices
- **3PE Stop** for protective devices

**Table** The functional difference is shown below.

	Emergency Stop	Safeguard Stop	3PE Stop
Robot stops moving	Yes	Yes	Yes
Program execution	Pauses	Pauses	Pauses
Drive power	Off	On	On
Reset	Manual	Automatic or manual	Automatic or manual
Frequency of use	Infrequent	Every cycle to infrequent	Every cycle to infrequent
Requires re-initialization	Brake release only	No	No
Stop Category (IEC 60204-1)	1	2	2
Performance level of monitoring function (ISO 13849-1)	PLd	PLd	PLd

**Safety caution** Use the configurable I/O to set up additional safety I/O functionality, e.g. Emergency Stop Output. Use the PolyScope interface to define a set of configurable I/O for safety functions.



**CAUTION**

Failure to verify and test the safety functions regularly can lead to hazardous situations.

- Safety functions shall be verified before putting the robot into operation.
- Safety functions shall be tested regularly.

**OSSD signals**

All configured and permanent safety inputs are filtered to allow the use of OSSD safety equipment with pulse lengths under 3ms. The safety input is sampled every millisecond and the state of the input is determined by the most frequently seen input signal over the last 7 milliseconds.

**OSSD Safety Signals**

You can configure the Control Box to output OSSD pulses when a safety output is inactive/high. OSSD pulses detect the ability of the Control Box to make safety outputs active/low. When OSSD pulses are enabled for an output, a 1ms low pulse is generated on the safety output once every 32ms. The safety system detects when an output is connected to a supply and shuts down the robot. The illustration below shows: the time between pulses on a channel (32ms), the pulse length (1ms) and the time from a pulse on one channel to a pulse on the other channel (18ms)

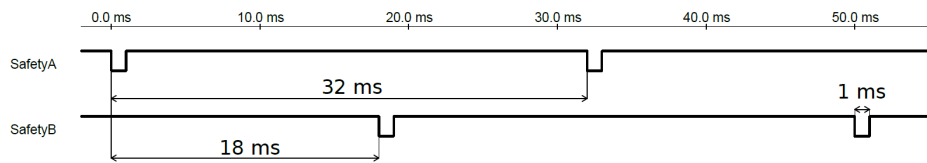

To enable OSSD for Safety Output

1. In the Header, tap **Installation** and select **Safety**.
2. Under **Safety**, select **I/O**.
3. On the I/O screen, under Output Signal, select the desired OSSD checkbox. You must assign the output signal to enable the OSSD checkboxes.

**Default safety configuration**

The robot is delivered with a default configuration, which enables operation without any additional safety equipment.

		Safety	
Emergency Stop	24V	<input checked="" type="checkbox"/>	<input checked="" type="checkbox"/>
	E10	<input checked="" type="checkbox"/>	<input checked="" type="checkbox"/>
Safeguard Stop	24V	<input checked="" type="checkbox"/>	<input checked="" type="checkbox"/>
	S10	<input checked="" type="checkbox"/>	<input checked="" type="checkbox"/>
	24V	<input checked="" type="checkbox"/>	<input checked="" type="checkbox"/>
	S11	<input checked="" type="checkbox"/>	<input checked="" type="checkbox"/>

**Connecting emergency stop buttons**

Most applications require one or more extra emergency stop buttons. The illustration below shows how one or more emergency stop buttons can be connected.

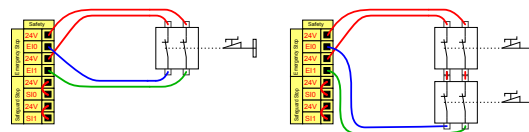

**Sharing the Emergency Stop with other machines**

You can set up a shared emergency stop function between the robot and other machines by configuring the following I/O functions via the GUI. The Robot Emergency Stop Input cannot be used for sharing purposes. If more than two UR robots or other machines need to be connected, a safety PLC must be used to control the emergency stop signals.

- Configurable input pair: External Emergency Stop.
- Configurable output pair: System Stop.

The illustration below shows how two UR robots share their emergency stop functions. In this example the configured I/Os used are CI0-CI1 and CO0-CO1.

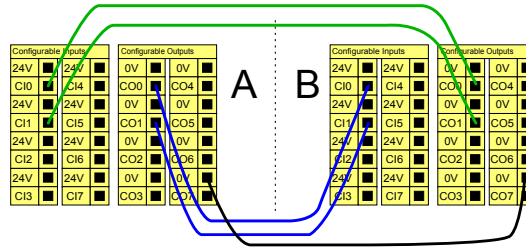

**Safeguard stop with automatic resume**

This configuration is only intended for applications where the operator cannot go through the door and close it behind him. The configurable I/O is used to setup a reset button outside the door to reactivate robot motion. The robot resumes movement automatically when the signal is re-established.



**WARNING**

Do not use this configuration if signal can be re-established from the inside of the safety perimeter.

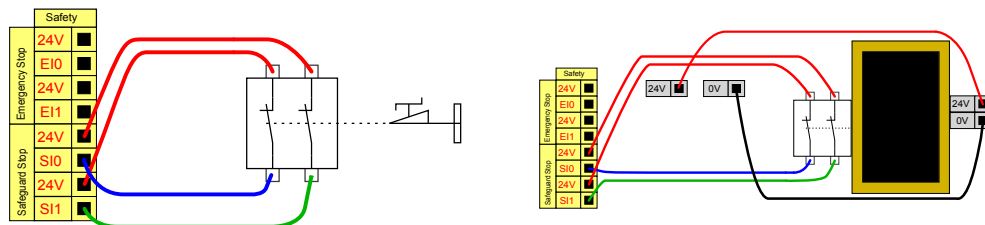

In this example a door switch is a basic safeguard device where the robot is stopped when the door is opened.

In this example a safety mat is a safety device where automatic resume is appropriate. This example is also valid for a safety laser scanner.

**Safeguard Stop with reset button**

If the safeguard interface is used to interact with a light curtain, a reset outside the safety perimeter is required. The reset button must be a two channel type. In this example the I/O configured for reset is CI0-CI1.

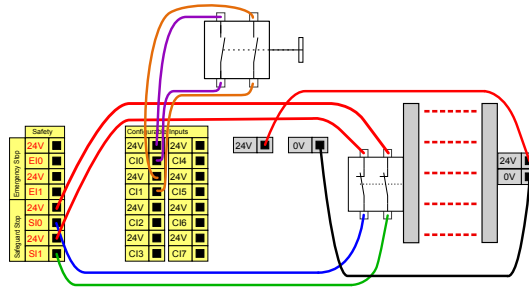

### 8.6.1. I/O Signals

**Description**

The I/O are divided between inputs and outputs and are paired up so that each function provides a Category 3 and PLd I/O.

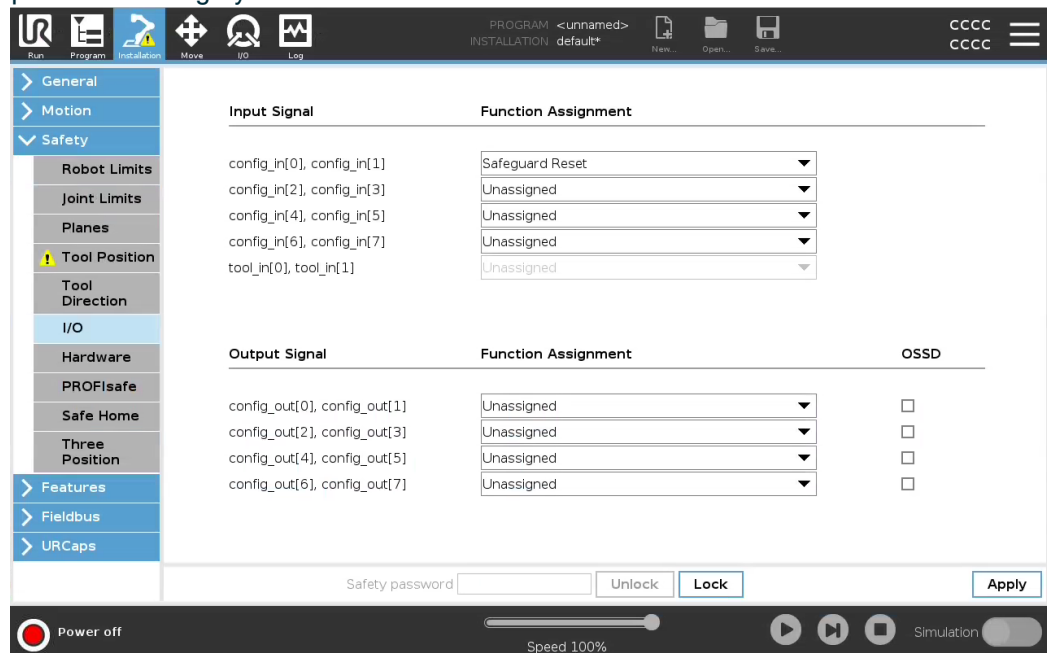

Copyright © 2009-2025 by Universal Robots A/S. All rights reserved.

**Control Box Inputs** The inputs are described in the tables below:

Emergency Stop Button	Performs a Stop Category 1 (IEC 60204-1) informing other machines using the System Stop output if that output is defined. A stop is initiated in anything connected to the output.
Robot Emergency Stop	Performs a Stop Category 1 (IEC 60204-1) via Control Box input, informing other machines using the System Emergency Stop Output if that output is defined.
External Emergency Stop	Performs a Stop Category 1 (IEC 60204-1) on robot only.
Reduced	<p>All safety limits can be applied while the robot is using a <b>Normal</b> configuration, or a <b>Reduced</b> configuration.</p> <p>When configured, a low signal sent to the inputs causes the safety system to transition to the reduced configuration. The robot arm decelerates to satisfy the reduced parameters.</p> <p>The safety system guarantees the robot is within reduced limits less than 0.5s after the input is triggered. If the robot arm continues to violate any of the reduced limits, a Stop Category 0 is triggered.</p> <p>Trigger planes can also cause a transition to the reduced configuration. The safety system transitions to the normal configuration in the same way.</p>

**Control Box Inputs** The inputs are described in the tables below:

Operational Mode	When an external mode selection is used it switches between <b>Automatic Mode</b> and <b>Manual Mode</b> . The robot is in Automatic mode when input is <i>low</i> and Manual mode when the input is <i>high</i> .
Safeguard Reset	Returns from the Safeguard Stop state, when a rising edge on the Safeguard Reset input occurs. When a Safeguard Stop occurs, this input ensures that the Safeguard Stop state continues until a reset is triggered.
Safeguard	A stop triggered by a safeguard input. Performs a Stop Category 2 (IEC 60204-1) in all modes, when triggered by a Safeguard.
Automatic Mode Safeguard Stop	Performs a Stop Category 2 (IEC 60204-1) in Automatic mode ONLY. Automatic Mode Safeguard Stop can only be selected when a Three-Position Enabling Device is configured and installed.
Automatic Mode Safeguard Reset	Returns from the Automatic Mode Safeguard Stop state when a rising edge on the Automatic Mode Safeguard Reset input occurs.
3-Position Enabling Device	In Manual Mode, an external 3-Position Enabling Device must be pressed and held in the center-on position to move the robot. If you are using a built-in 3-Position Enabling Device, the button must be pressed and held in the mid position to move the robot.
Freedrive on robot	You can configure the Freedrive input to enable and use Freedrive without pressing the Freedrive button on a standard TP, or without having to press-and-hold any of the buttons on the 3PE TP in the light-press position.



**WARNING**

When the default Safeguard Reset is disabled, an automatic reset happens when the safeguard no longer triggers a stop. This can happen if a person passes through the field of the safeguard. If a person is not detected by the safeguard and the person is exposed to hazards, automatic reset is forbidden by standards.

- Use the external reset to ensure resetting only when a person is not exposed to hazards.



**WARNING**

When Automatic Mode Safeguard stop is enabled, a safeguard Stop is not triggered in Manual Mode.

**Control Box Outputs** All safety outputs go low in the event of a safety system violation or fault. This means the System Stop output initiates a stop even when an E-stop is not triggered. You can use the following Safety functions output signals. All signals return to low when the state which triggered the high signal has ended:

1System Stop	Signal is <i>Low</i> when the safety system has been triggered into a stopped state including by the Robot Emergency Stop input or the Emergency Stop Button. To avoid deadlocks, if the Emergency Stopped state is triggered by the System Stop input, low signal will not be given.
Robot Moving	Signal is <i>Low</i> if the robot is moving, otherwise high.
Robot Not Stopping	Signal is <i>High</i> when the robot is stopped or in the process of stopping due to an emergency stop or safeguard stop. Otherwise it will be logic low.
Reduced	Signal is <i>Low</i> when reduced parameters are active or if the safety input is configured with a reduced input and the signal is currently low. Otherwise the signal is high.
Not Reduced	This is the inverse of Reduced, defined above.
Safe Home	Signal is <i>High</i> if the Robot Arm is stopped and is located in the configured Safe Home Position. Otherwise, the signal is <i>Low</i> . This is often used when UR robots are integrated with mobile robots.
3-Position Enabling Stopped	Signal is low when a three position stop is active, high otherwise.
Not 3-Position Enabling Stopped	Signal is low when a three position stop is inactive, high otherwise.



#### NOTICE

Any external machinery receiving its Emergency Stop state from the robot through the System Stop output must comply with ISO 13850. This is particularly necessary in setups where the Robot Emergency Stop input is connected to an external Emergency Stop device. In such cases, the System Stop output becomes high when the external Emergency Stop device is released. This implies that the emergency stop state at the external machinery will be reset with no manual action needed from the robot's operator. Hence, to comply with safety standards, the external machinery must require manual action in order to resume.

<sup>1</sup>System Stop was previously known as "System Emergency Stop" for Universal Robots robots. PolyScope can display "System Emergency Stop".

## 8.6.2. I/O Setup

**Description** Use the I/O Setup screen to define I/O signals and configure actions with the I/O tab control. The types of I/O signals are listed under **Input** and **Output**. You can use a fieldbus, for example, Profinet and EtherNet/IP, to access the general purpose registers. If you enable the Tool Communication Interface (TCI), the tool analog input becomes unavailable.

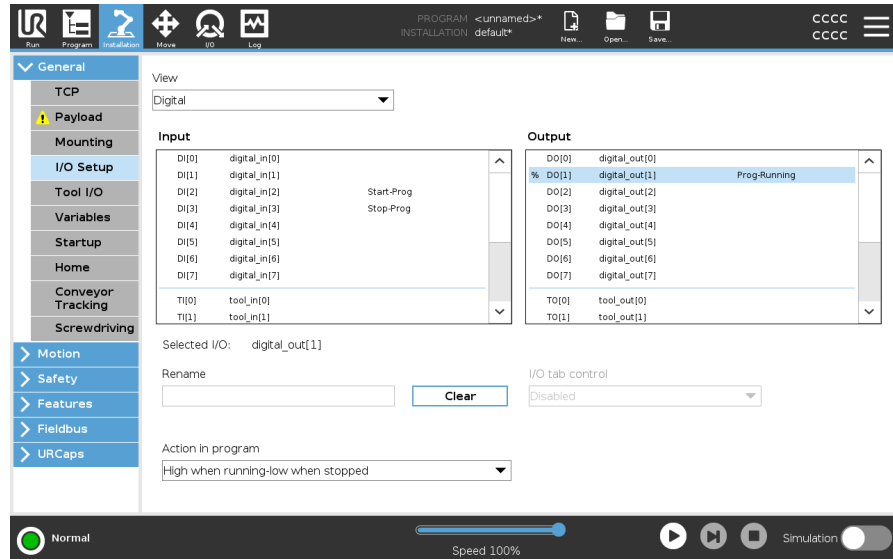

### NOTICE

When starting programs from an I/O or fieldbus input, the robot can begin movement from the position it has, there will not be any manual movement to the first waypoint via PolyScope required.

**I/O Signal Type** To limit the number of signals listed under **Input** and **Output**, use the **View** drop-down menu to change the displayed content based on signal type.

**Assigning User-defined Names** You can name the Input and Output signals to easily identify the ones being used.

1. Select the desired signal.
2. Tap the text field to type a name for the signal.
3. To reset the name to default, tap **Clear**.

You must provide a user-defined name for a general purpose register to make it available in the program (i.e., for a **Wait** command or the conditional expression of an **If** command). The **Wait** and **If** commands are described in ([Wait](#)) and ([If](#)), respectively. You can find named general purpose registers in the **Input** or **Output** selector on the **Expression Editor** screen.

**I/O Actions and I/O Tab Control** You can use Physical and Fieldbus digital I/Os to trigger actions or react to the status of a program.

---

**I/O Tab Control** Use I/O Tab Control to specify whether an output is controlled on the I/O tab (by either programmers, or both operators and programmers), or if it is controlled by the robot programs.

---

**Available Input Actions**

Command	Action
Start	Starts or resumes the current program on a rising edge (only enabled in Remote Control)
Stop	Stops the current program on a rising edge
Pause	Pauses the current program on a rising edge
Freedrive	When the input is high, the robot goes into freedrive (similar to the freedrive button). The input is ignored if other conditions disallow freedrive.



**WARNING**

If the robot is stopped while using the Start input action, the robot slowly moves to the first waypoint of the program before executing that program. If the robot is paused while using the Start input action, the robot slowly moves to the position from where it was paused before resuming that program.

**Available Output Actions**

Action	Output state	Program state
Low when not running	Low	Stopped or paused
High when not running	High	Stopped or paused
High when running, low when stopped	Low High	Running, Stopped or paused
Low on unscheduled stop	Low	Program terminated unscheduled
Low on unscheduled stop, otherwise High	Low High	Program terminated unscheduled Running, stopped or paused
Continuous Pulse	Alternates between high and low	Running (pause or stop the program to maintain the pulse state)

---



**Program  
Termination  
Cause**

An unscheduled program termination can occur for any of the reasons listed below:

- Robot stop
  - Fault
  - Violation
  - Runtime exception
-

### 8.6.3. Using I/O for Mode Selection

---

**Description** The robot can be configured to switch between operational modes without using the Teach Pendant. This means using the TP is prohibited when switching from Automatic mode to Manual mode and from Manual mode to Automatic mode.

Switching modes without the use of the Teach Pendant requires safety I/O configuration and a secondary device as a mode selector.

---

**Mode selector** The mode selector can be a key switch with a redundant electrical layout or with signals from a dedicated safety PLC.

---

### 8.6.4. Three Position Enabling Device

**Description**

The robot arm is equipped with an enabling device in the form of the 3PE Teach Pendant. The Control Box supports the following enabling device configurations:

- 3PE Teach Pendant
- External Three-Position Enabling device
- External Three-Position device and 3PE Teach Pendant

The illustration below shows how to connect a Three-Position Enabling device.

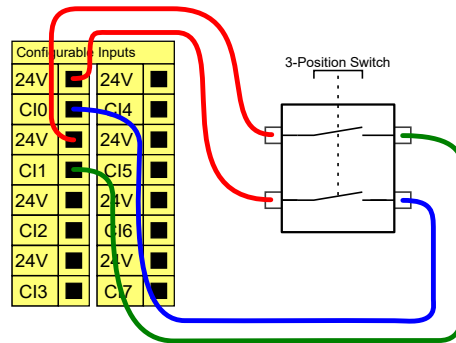

Note: The two input channels for the Three-Position Enabling Device input have a disagreement tolerance of 1 second.



**NOTICE**

The UR robot safety system does not support multiple external Three-Position Enabling Devices.

**Operational Mode Switch**

Using a Three-Position Enabling device requires the use of an Operational Mode switch.

The illustration below shows an Operational Mode switch.

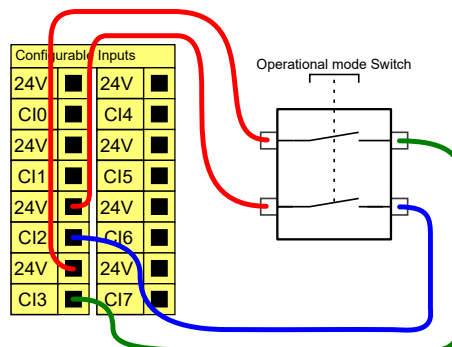

## 8.7. General Purpose Digital I/O

**Description** The Startup screen contains settings for automatically loading and starting a default program, and for auto-initializing the Robot arm during power up.

**General purpose digital I/O** This section describes the general purpose 24V I/O (Gray terminals) and the configurable I/O (Yellow terminals with black text) when not configured as safety I/O.

The general purpose I/O can be used to drive equipment like pneumatic relays directly or for communication with other PLC systems. All Digital Outputs can be disabled automatically when program execution is stopped. In this mode, the output is always low when a program is not running. Examples are shown in the following subsections. These examples use regular Digital Outputs but any configurable outputs could also have been used if they are not configured to perform a safety function.

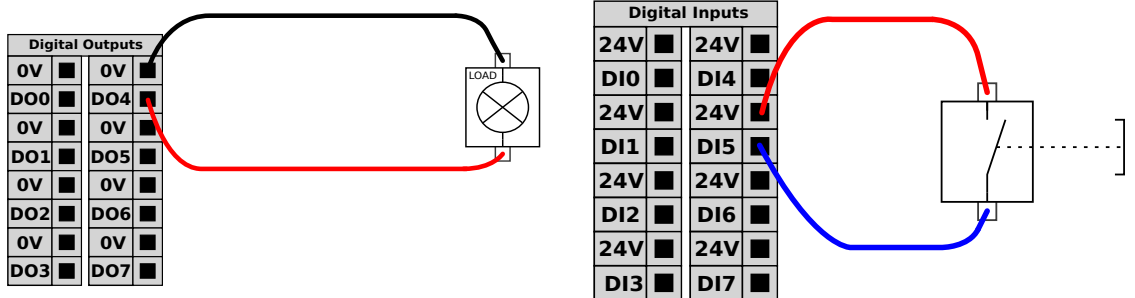

In this example a load is controlled from a Digital Outputs when connected.

In this example a simple button is connected to a Digital Input.

**Communication with other machines or PLCs** You can use the digital I/O to communicate with other equipment if a common GND (0V) is established and if the machine uses PNP technology, see below.

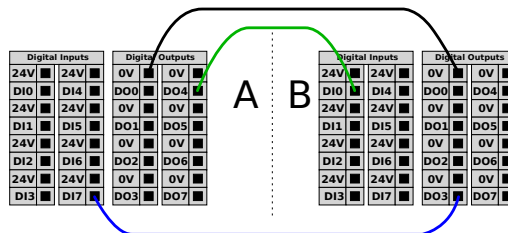

**NOTICE**

Use shielded cables to connect Digital I/Os.

Copyright © 2009-2025 by Universal Robots A/S. All rights reserved.

### 8.7.1. Remote ON/OFF control

**Description** Use remote **ON/OFF** control to turn the Control Box on and off without using the Teach Pendant. It is typically used:

- When the Teach Pendant is inaccessible.
- When a PLC system must have full control.
- When several robots must be turned on or off at the same time.

**Remote Control** The remote **ON/OFF** control provides a auxiliary 12V supply, kept active when the Control Box is turned off. The **ON** input is intended only for short time activation and works in the same way as the **POWER** button. The **OFF** input can be held down as desired. Use a software feature to load and start programs automatically.

The electrical specifications are shown below.

Terminals	Parameter	Min	Typ	Max	Unit
[12V - GND]	Voltage	10	12	13	V
[12V - GND]	Current	-	-	100	mA
[ON / OFF]	Inactive voltage	0	-	0.5	V
[ON / OFF]	Active voltage	5	-	12	V
[ON / OFF]	Input current	-	1	-	mA
[ON]	Activation time	200	-	600	ms

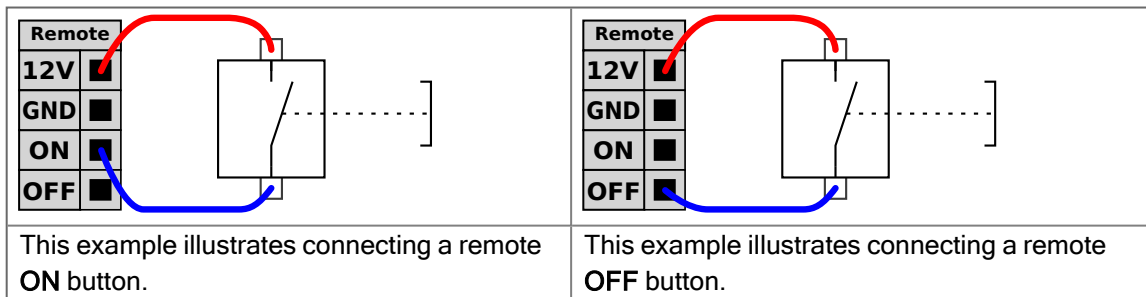

**CAUTION**

Maintaining a press and hold on the power button switches the Control Box OFF without saving.

- Do not press and hold the **ON** input or the **POWER** button without saving.
- Use the **OFF** input for remote off control to allow the Control Box to save open files and shut down correctly.

## 8.8. General Purpose Analog I/O

### Description

The analog I/O interface is the green terminal. It is used to set or measure voltage (0-10V) or current (4-20mA) to and from other equipment.

The following directions is recommended to achieve the highest accuracy.

- Use the AG terminal closest to the I/O. The pair share a common mode filter.
- Use the same GND (0V) for equipment and Control Box. The analog I/O is not galvanically isolated from the Control Box.
- Use a shielded cable. Connect the shield to the GND terminal at the terminal called **Power**.
- Use equipment that works in current mode. Current signals are less sensitive to interferences.

### Electrical Specifications

In the GUI you can select input modes. The electrical specifications are shown below.

Terminals	Parameter	Min	Typ	Max	Unit
<i>Analog Input in current mode</i>					
[AIx - AG]	Current	4	-	20	mA
[AIx - AG]	Resistance	-	20	-	ohm
[AIx - AG]	Resolution	-	12	-	bit
<i>Analog Input in voltage mode</i>					
[AIx - AG]	Voltage	0	-	10	V
[AIx - AG]	Resistance	-	10	-	Kohm
[AIx - AG]	Resolution	-	12	-	bit
<i>Analog Output in current mode</i>					
[AOx - AG]	Current	4	-	20	mA
[AOx - AG]	Voltage	0	-	24	V
[AOx - AG]	Resolution	-	12	-	bit
<i>Analog Output in voltage mode</i>					
[AOx - AG]	Voltage	0	-	10	V
[AOx - AG]	Current	-20	-	20	mA
[AOx - AG]	Resistance	-	1	-	ohm
[AOx - AG]	Resolution	-	12	-	bit

**Analog Output and Analog Input**

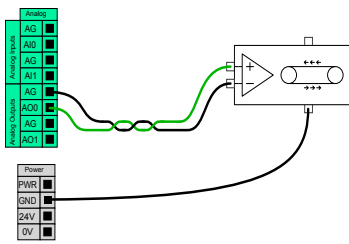

This example illustrates controlling a conveyor belt with an analog speed control input.

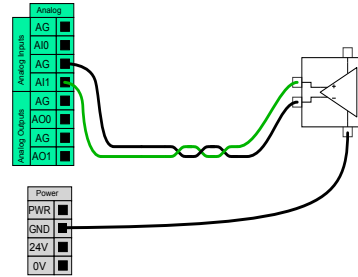

This example illustrates connecting an analog sensor.

### 8.8.1. Analog Input: Communication Interface

**Description**

The Tool Communication Interface (TCI) enables the robot to communicate with an attached tool via the robot tool analog input. This removes the need for external cabling. Once the Tool Communication Interface is enabled, all tool analog inputs are unavailable

**Tool Communication Interface**

1. Tap the Installation tab and under General tap Tool I/O.
2. Select Communication Interface to edit TCI settings. Once the TCI is enabled, the tool analog input is unavailable for the I/O Setup of the Installation and does not appear in the input list. Tool analog input is also unavailable for programs as Wait For options and expressions.
3. In the drop-down menus under Communication Interface, select required values. Any changes in values are immediately sent to the tool. If any installation values differ from what the tool is using, a warning appears.

# 9. End Effector Integration

---

**Description** The end effector can also be referred to as the tool and the workpiece in this manual.



## NOTICE

UR provides documentation for the end effector to be integrated with the robot arm.

- Refer to the documentation specific to the end effector/tool/workpiece for mounting and connection.

## 9.1. Maximum Payload

---

**Description** The rated robot arm payload depends on the center of gravity (CoG) offset of the payload, as shown below. The CoG offset is defined as the distance from the center of the tool flange to the center of gravity of the attached payload.

The robot arm can accommodate a long center of gravity offset, if the payload is placed below the tool flange. For example when computing the payload mass in a pick and place application, consider both the gripper and the workpiece.

The robot's capacity to accelerate can be reduced if the payload CoG exceeds the robot's reach and payload. You can verify the reach and payload of your robot in the Technical Specifications.

Payload [kg]

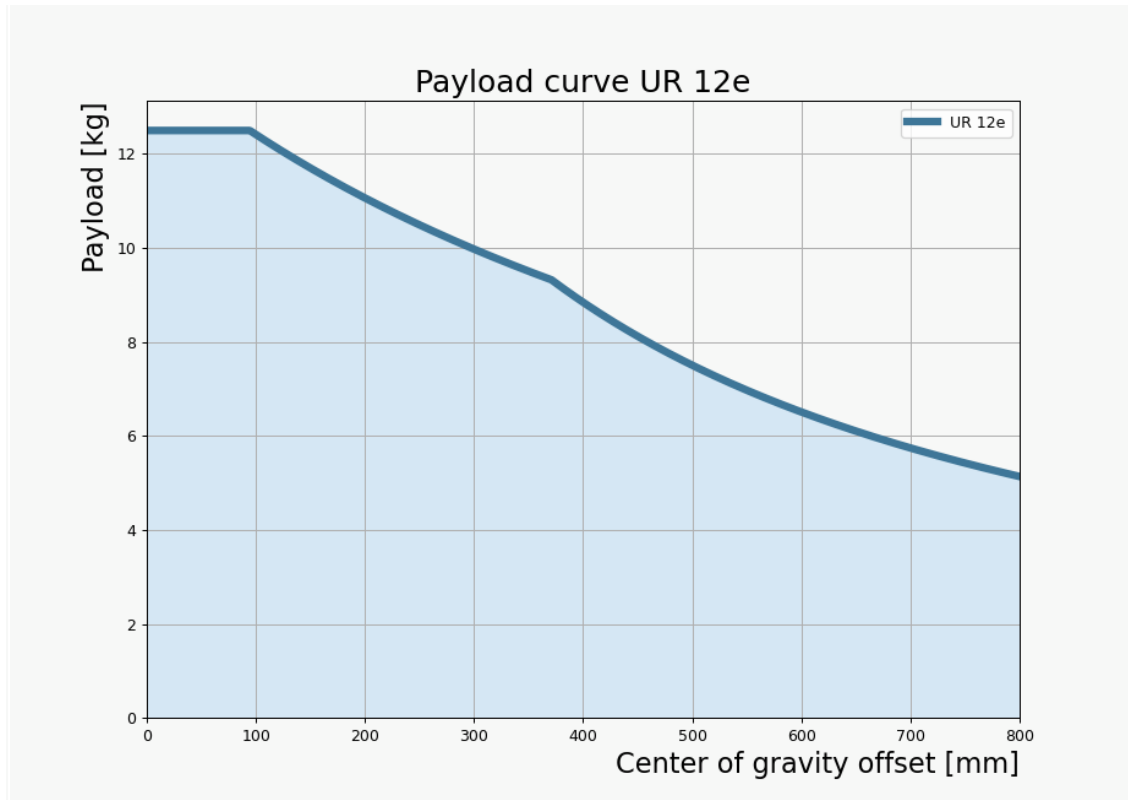

Center of gravity offset [mm]

*The relationship between the rated payload and the center of gravity offset.*

**Payload inertia**

You can configure high inertia payloads, if the payload is set correctly. The controller software automatically adjusts accelerations when the following parameters are correctly configured:

- Payload mass
- Center of gravity
- Inertia

You can use the URSim to evaluate the accelerations and cycle times of the robot motions with a specific payload.



## 9.3. Tool I/O

### Tool Connector

The tool connector illustrated below provides power and control signals for the grippers and sensors used on a specific robot tool. The tool connector has eight holes and is located next to the tool flange on Wrist 3.

The eight wires inside the connector have different functions, as listed in the table:

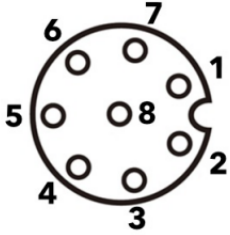
	Pin #	Signal	Description
	1	AI3 / RS485-	Analog in 3 or RS485-
	2	AI2 / RS485+	Analog in 2 or RS485+
	3	TO0/PWR	Digital Outputs 0 or 0V/12V/24V
	4	TO1/GND	Digital Outputs 1 or Ground
	5	POWER	0V/12V/24V
	6	TI0	Digital Inputs 0
	7	TI1	Digital Inputs 1
	8	GND	Ground



#### NOTICE

The Tool Connector must be manually tightened up to a maximum of 0.4 Nm.

**Tool Cable Adapter** The Tool Cable Adapter is the electronic accessory that allows compatibility between the tool I/O and e-Series tools.

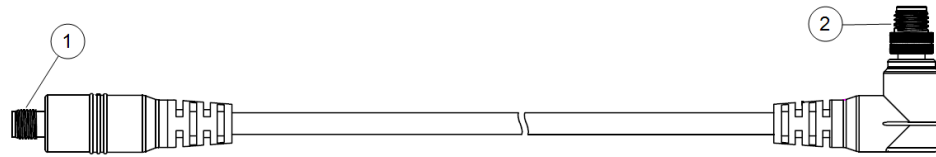

- 1 Connects to the tool/end effector.
- 2 Connects to the robot.



**WARNING**

Connecting the Tool Cable Adapter to a robot that is powered on can lead to injury.

- Connect the adapter to the tool/end effector before connecting the adapter to the robot.
- Do not power on the robot if the Tool Cable Adapter is not connected to the tool/end effector.

The eight wires inside the Tool Cable Adapter have different functions, as listed in the table below:

	Pin #	Signal	Description
	1	AI2 / RS485+	Analog in 2 or RS485+
	2	AI3 / RS485-	Analog in 3 or RS485-
	3	TI1	Digital Inputs 1
	4	TI0	Digital Inputs 0
	5	POWER	0V/12V/24V
	6	TO1/GND	Digital Outputs 1 or Ground
	7	TO0/PWR	Digital Outputs 0 or 0V/12V/24V
	8	GND	Ground



**GROUND**

The tool flange is connected to GND (Ground).

### 9.3.1. Tool I/O Installation Specifications

---

**Description** The electrical specifications are shown below. Access Tool I/O in the Installation Tab to set the internal power supply to 0V, 12V or 24V.

Parameter	Min	Typ	Max	Unit
Supply voltage in 24V mode	23.5	24	24.8	V
Supply voltage in 12V mode	11.5	12	12.5	V
Supply current (single pin)*	-	1000	2000**	mA
Supply current (dual pin)*	-	2000	2000**	mA
Supply capacitive load	-	-	8000***	uF

\* It is highly recommended to use a protective diode for inductive loads.

\*\* Peak for max 1 second, duty cycle max: 10%. Average current over 10 seconds must not exceed typical current.

\*\*\* When tool power is enabled, a 400 ms soft start time begins allowing a capacitive load of 8000 uF to be connected to the tool power supply at start-up. Hot-plugging the capacitive load is not allowed.

---

### 9.3.2. Tool Power Supply

**Description** Access Tool I/O in the Installation Tab

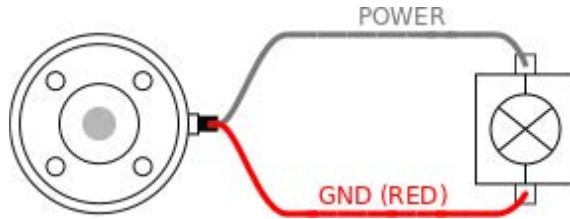

**Dual Pin Power Supply**

In Dual Pin Power mode, the output current can be increased as listed in Tool I/O.

1. In the Header, tap **Installation**.
2. In the list on the left, tap **General**.
3. Tap **Tool IO** and select **Dual Pin Power**.
4. Connect the wires Power (gray) to TO0 (blue) and Ground (red) to TO1 (pink).

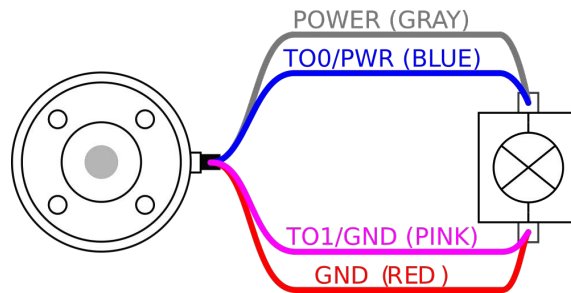

**NOTICE**

Once the robot makes an Emergency Stop, the voltage is set to 0V for both Power Pins (power is off).

### 9.3.3. Tool Digital Inputs

**Description** The Startup screen contains settings for automatically loading and starting a default program, and for auto-initializing the Robot arm during power up.

**Table** The Digital Inputs are implemented as PNP with weak pull-down resistors. This means that a floating input always reads as low. The electrical specifications are shown below.

Parameter	Min	Type	Max	Unit
Input voltage	-0.5	-	26	V
Logical low voltage	-	-	2.0	V
Logical high voltage	5.5	-	-	V
Input resistance	-	47k	-	$\Omega$

**Using the Tool Digital Inputs**

This example illustrates connecting a simple button.

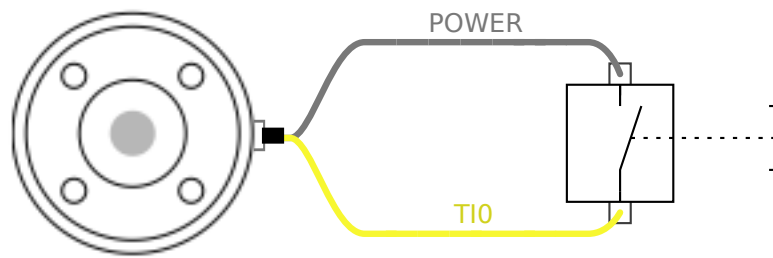

### 9.3.4. Tool Digital Outputs

**Description** Digital Outputs support three different modes:

Mode	Active	Inactive
Sinking (NPN)	Low	Open
Sourcing (PNP)	High	Open
Push / Pull	High	Low

Access Tool I/O in the Installation Tab to configure the output mode of each pin. The electrical specifications are shown below:

Parameter	Min	Typ	Max	Unit
Voltage when open	-0.5	-	26	V
Voltage when sinking 1A	-	0.08	0.09	V
Current when sourcing/sinking	0	600	1000	mA
Current through GND	0	1000	3000*	mA



**NOTICE**

Once the robot makes an Emergency Stop, the Digital Outputs (DO0 and DO1) are deactivated (High Z).



**CAUTION**

The Digital Outputs in the tool are not current-limited. Overriding the specified data can cause permanent damage.

**Using Tool Digital Outputs**

This example illustrates turning on a load using the internal 12V or 24V power supply. The output voltage at the I/O tab must be define. There is voltage between the POWER connection and the shield/ground, even when the load is turned off.

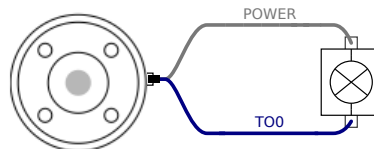

It is recommended to use a protective diode for inductive loads, as shown below.

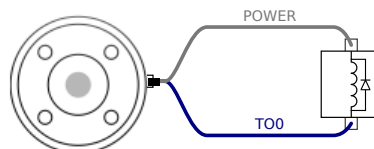

Copyright © 2009-2025 by Universal Robots A/S. All rights reserved.

### 9.3.5. Tool Analogue Inputs

**Description** Tool Analogue Input are non-differential and can be set to either voltage (0-10V) or current (4-20mA) on the I/O tab. The electrical specifications are shown below.

Parameter	Min	Type	Max	Unit
Input voltage in voltage mode	-0.5	-	26	V
Input resistance @ range 0V to 10V	-	10.7	-	kΩ
Resolution	-	12	-	bit
Input voltage in current mode	-0.5	-	5.0	V
Input current in current mode	-2.5	-	25	mA
Input resistance @ range 4mA to 20mA	-	182	188	Ω
Resolution	-	12	-	bit

Two examples of using Analog Input are shown in the following subsections.

**Caution**



**CAUTION**

Analog Inputs are not protected against over voltage in current mode. Exceeding the limit in the electrical specification can cause permanent damage to the input.

**Using Tool Analog Inputs, Non-differential**

This example shows an analog sensor connection with a non-differential output. The sensor output can be either current or voltage, as long as the input mode of that Analog Input is set to the same on the I/O tab.

Note: You can check that a sensor with voltage output can drive the internal resistance of the tool, or the measurement might be invalid.

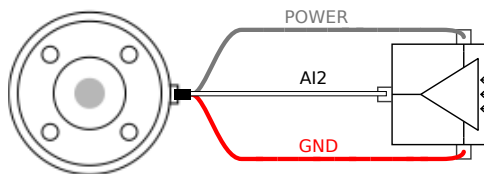

**Using Tool Analog Inputs, differential**

This example shows an analog sensor connection with a differential output. Connecting the negative output part to GND (0V), works in the same way as a non-differential sensor.

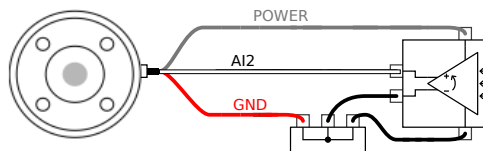

## 9.4. Set Payload

### Description

The Set Payload command allows you to configure the payload for the robot. Payload is the combined weight of everything attached to the robot tool flange.

When to use:

- When adjusting the payload weight to prevent the robot from triggering a robot stop. A correctly configured payload weight ensures optimal robot movement.

Setting the payload correctly ensures optimal motion performance and avoids robot stops.

- When setting up the payload for use in a pick and place program, using a gripper.

### Set Payload

#### Use the Set Payload command

1. In your robot program, select the place or node where you wish to add a Set command.
2. Under Basic, tap **Set Payload**.
3. Use the drop-down, under **Select Payload**.
  - a. Select one of the payloads already configured.
  - b. Or, use the drop-down to configure a new payload by selecting **Custom Payload** and completing the mass and CoG fields.

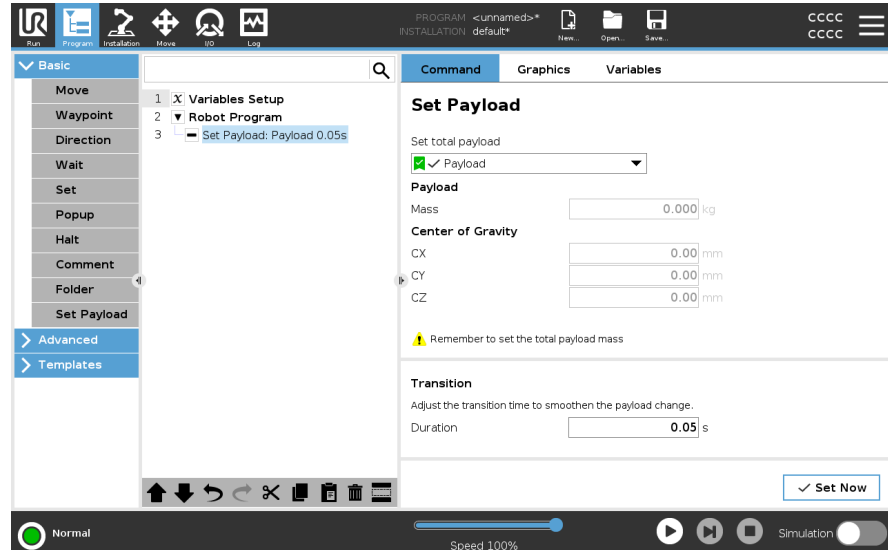

#### Tip

You can also use the **Set Now** button to set the values on the node as the active payload.

#### Use tip

Remember to always update your payload when making any changes to the configuration of the robot program.

#### Example: Set Payload

In a pick and place program, you would create a default payload in the installation. Then you add a Set Payload when picking up an object. You would update the payload after the gripper closes, but before starting to move. Additionally, you would use the Set Payload after the object has been released.



**Payload** This is the time it takes the robot to adjust for a given payload. At the bottom of the screen, you can set the transition time between different payloads.

**Transition Time** You can add a payload transition time in seconds. Setting a transition time larger than zero, prevents the robot from doing a small "jump", when the payload changes. The program continues while the adjustment is taking place. Using the Payload Transition Time is recommended when picking up or releasing heavy objects or using a vacuum gripper.

---

### 9.4.1. Payload

**Description**

You must set the Payload, the CoG and the inertia for the robot to perform optimally. You can define multiple Payloads, and switch between them in your program. This is useful in Pick and Place applications, for example, where the robot picks up and releases an object.

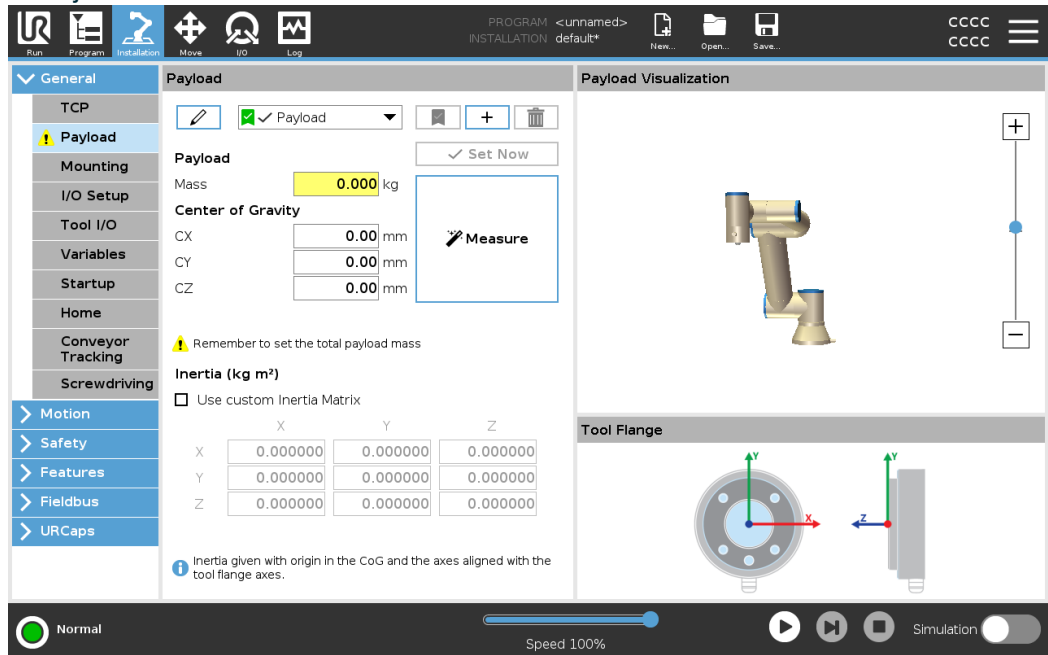

**Adding, Renaming, Modifying and Removing Payloads**

You can start configuring a new Payload with the following actions:

- Tap the to define a new Payload with a unique name. The new payload is available in the drop-down menu.
- Tap the to rename a Payload.
- Tap the to remove a selected Payload. You cannot remove the last Payload.

**Active Payload**

The checkmark in the drop-down indicates which payload is active . The active Payload can be changed using the .

**Default Payload**

The default Payload is set as the active Payload before the program starts.

- Select the desired Payload and tap **Set as default** to set a Payload as the default.

The green icon in the drop-down menu indicates the default configured Payload



**Setting the Center of Gravity**

Tap the fields CX, CY and CZ to set the center of gravity. The settings apply to the selected Payload.

## Payload Estimation

This feature allows the robot to help set the correct Payload and Center of Gravity (CoG).

---

## Using the Payload Estimation Wizard

1. In the Installation Tab, under General, select **Payload**.
2. On the Payload screen, tap **Measure**.
3. In the Payload Estimation Wizard tap **Next**.
4. Follow the steps in the Payload Estimation Wizard to set the four positions. Setting the four positions requires moving the robot arm into four different positions. The load of the payload is measured at each position.
5. Once all measurements are complete, you can verify the result and tap **Finish**.



### NOTICE

Follow the these guidelines for best Payload Estimation results:

- Ensure the TCP positions are as different as possible from each other
  - Perform the measurements within a short timespan
  - Avoid pulling on the tool and/or attached payload before and during estimation
  - Robot mounting and angle must be correctly defined in the installation
-

**Setting  
Inertia  
Values**

You can select **Use custom Inertia Matrix** to set inertia values.  
 Tap the fields:  $I_{XX}$ ,  $I_{YY}$ ,  $I_{ZZ}$ ,  $I_{XY}$ ,  $I_{XZ}$  and  $I_{YZ}$  to set the inertia for the selected Payload.  
 The inertia is specified in a coordinate system with the origin at the Center of Gravity (CoG) of the payload and the axes aligned with the tool flange axes.  
 The default inertia is calculated as the inertia of a sphere with the user specified mass, and a mass density of  $1\text{g/cm}^3$

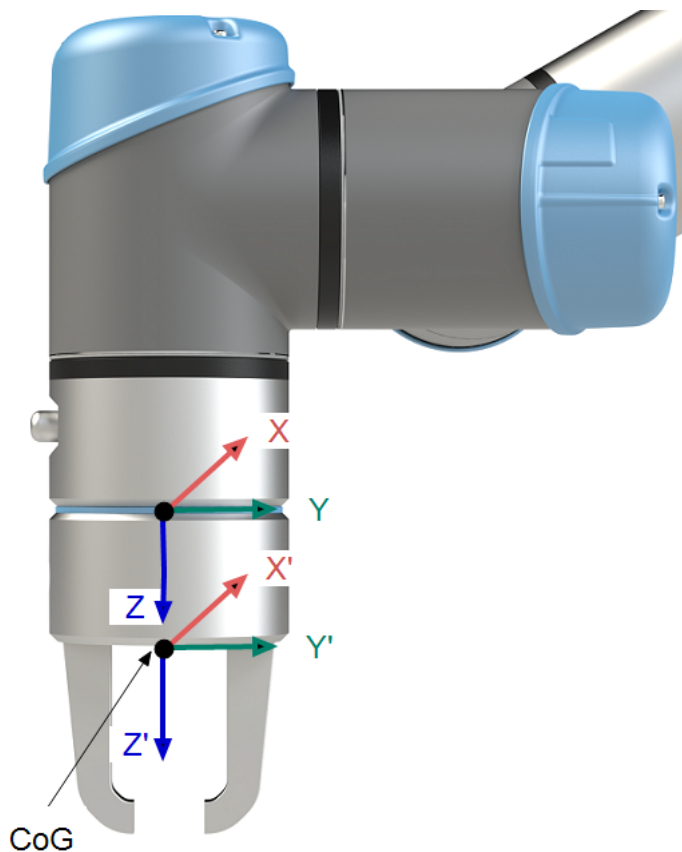

Copyright © 2009-2025 by Universal Robots A/S. All rights reserved.

# 10. Configuration

**Description** This section describes how you get started using the robot. Among other things, it covers easy start-up, an overview of the PolyScope user interface and how to set up your first program. Additionally, it covers freedrive mode and basic operation.

## 10.1. Quick System Start-up

### Quick System Start

#### MANDATORY ACTION

Before using the PolyScope, verify that the robot arm and Control Box are correctly installed.

This is how you quickly start up the robot.

1. On the **Teach Pendant**, press the emergency stop button.
2. On the Teach Pendant, press the power button and allow the system to start, displaying text on the **PolyScope**.
3. A popup appears on the touch screen indicating that the system is ready and that the robot must be initialized.
4. In the popup dialog, tap **Go to Initialize Screen** to access the Initialize screen.
5. Unlock the emergency stop button to change the robot state from **Emergency Stopped** to **Power off**.
6. Step outside the reach (workspace) of the robot.
7. On the **Initialize Robot** screen, tap the **ON** button and allow the robot state to change to **Idle**.
8. In the **Payload** field, in **Active Payload**, verify the payload mass. You can also verify that the mounting position is correct, in the **Robot** field.
9. Tap the **Start** button, for the robot to release its brake system. The robot vibrates and makes clicking sounds, indicating it is ready to be programmed.



#### NOTICE

Learn to program your Universal Robots robot on [www.universal-robots.com/academy/](http://www.universal-robots.com/academy/)

## 10.2. Safety-related Functions and Interfaces

### Description

Universal Robots robots are equipped with a range of built-in safety functions as well as safety I/O, digital and analog control signals to or from the electrical interface, to connect to other machines and additional protective devices. Each safety function and I/O is constructed according to EN ISO13849-1 with Performance Level d (PLd) using a category 3 architecture.



#### WARNING

The use of safety configuration parameters different from those determined as necessary for risk reduction, can result in hazards that are not reasonably eliminated, or risks that are not sufficiently reduced.

- Ensure tools and grippers are connected correctly to avoid hazards due to interruption of power.



#### WARNING: ELECTRICITY

Programmer and/or wiring errors can cause the voltage to change from 12V to 24V leading to fire damage to equipment.

- Verify the use of 12V and proceed with caution.



#### NOTICE

- The use and configuration of safety functions and interfaces must follow the risk assessment procedures for each robot application.
- The stopping time should be taken into account as part of the application risk assessment
- If the robot detects a fault or violation in the safety system (e.g. if one of the wires in the Emergency Stop circuit is cut or a safety limit is exceeded), then a Stop Category 0 is initiated.



#### NOTICE

The end effector is not protected by the UR safety system. The functioning of the end effector and/or connection cable is not monitored

## 10.2.1. Passwords

---

<b>Description</b>	<p>You can create and manage different types of password in PolyScope. An initial password must be set to access the full safety settings. The following password types are described below:</p> <ul style="list-style-type: none"> <li>• Administrator</li> <li>• Operational</li> </ul>
--------------------	---

---

## Password Settings

---

<b>To set a Password</b>	<p>You must set a password to Unlock all safety settings that make up your Safety Configuration. If no safety password is applied, you are prompted to set it up.</p> <ol style="list-style-type: none"> <li>1. In your PolyScope header right corner, press the <b>Hamburger</b> menu and select <b>Settings</b>.</li> <li>2. On the left of the screen, in the blue menu, press <b>Password</b> and select <b>Safety</b>.</li> <li>3. In <b>New password</b>, type a password.</li> <li>4. Now, in <b>Confirm new password</b>, type the same password and press <b>Apply</b>.</li> <li>5. In the bottom left of the blue menu, press <b>Exit</b> to return to previous screen.</li> </ol> <p>You can press the <b>Lock</b> tab to lock all Safety settings again or simply navigate to a screen outside of the Safety menu.</p>
--------------------------	--

Safety password

---

## Administrator Password

### Description

Use the Administrator (Admin) Password to change the security configuration of the system, including network access.

The Admin password is equal to the password used for the root user account on the Linux system running on the robot, which may be needed in some network use cases such as SSH or SFTP.



### WARNING

You cannot recover a lost Admin password.

- Take the appropriate steps to ensure your admin password is not lost.

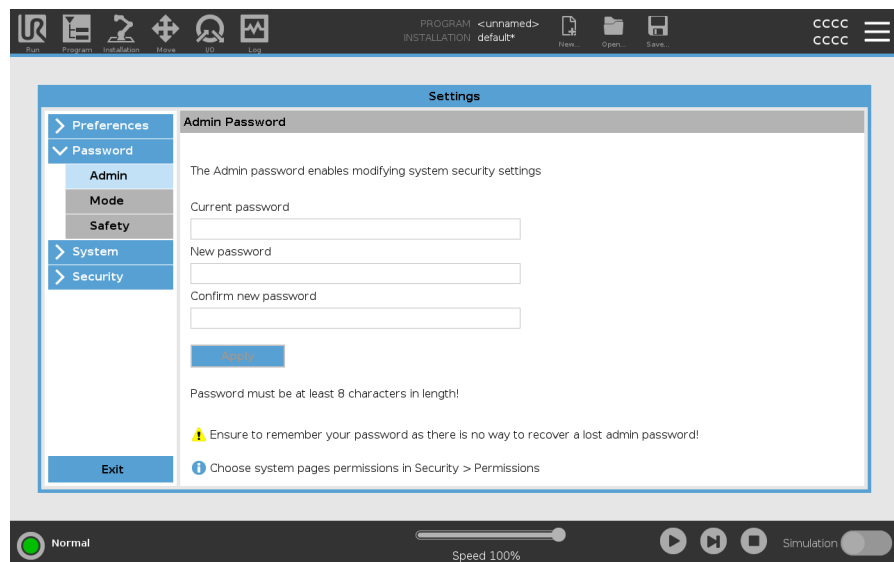

### To set the Admin Password

1. In the Header, tap the Hamburger menu icon and select **Settings**.
2. Under **Password**, tap **Admin**.
3. Under **Current password**, put in the default password: **easybot**.
4. Under **New password**, create a new password.  
Creating a strong, secret password obtains the best security for your system.
5. Under **Confirm new password**, repeat your new password.
6. Tap **Apply** to confirm your password change.

### Safety

The Safety password prevents unauthorized modification of the Safety settings.

## Operational Password

**Description** The Operational Mode Password, or mode password, creates two different user roles on PolyScope:

- Manual
- Automatic

When the mode password is set, programs and installations can only be created and edited in Manual mode. Automatic mode only allows the operator to load pre-made programs. Once a password has been set, a new Mode icon appears in the Header.

Switching operational modes, from Manual to Automatic and from Automatic to Manual, causes PolyScope to prompt for the new password.

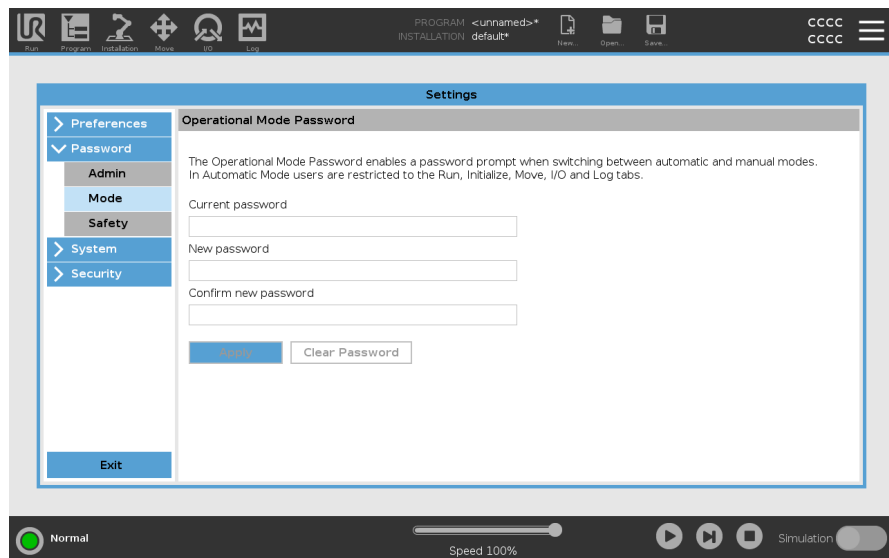

### To set the Mode Password

1. In the Header, tap the Hamburger menu icon and select **Settings**.
2. Under **Password**, tap **Mode**.
3. Under **New password**, create a new password.  
Creating a strong, secret password obtains the best security for your system.
4. Under **Confirm new password**, repeat your new password.
5. Tap **Apply** to confirm your password change.

## 10.2.2. Setting a Software Safety Password

---

**Description** You must set a password to Unlock all safety settings that make up your Safety Configuration. If no safety password is applied, you are prompted to set it up.

---

**To set a Software Safety password**

You can tap the **Lock** tab to lock all Safety settings again or simply navigate to a screen outside of the Safety menu.

1. In your PolyScope header right corner, press the **Hamburger** menu and select **Settings**.
2. On the left of the screen, in the blue menu, press **Password** and select **Safety**.
3. In **New password**, type a password.
4. Now, in **Confirm new password**, type the same password and press **Apply**.
5. In the bottom left of the blue menu, press **Exit** to return to previous screen.

Safety password

---

### 10.2.3. Configurable Safety Functions

#### Description

Universal Robots robot safety functions, as listed in the table below, are in the robot but are meant to control the robot system i.e. the robot with its attached tool/end effector. The robot safety functions are used to reduce robot system risks determined by the risk assessment. Positions and speeds are relative to the base of the robot.

Safety Function	Description
Joint Position Limit	Sets upper and lower limits for the allowed joint positions.
Joint Speed Limit	Sets an upper limit for joint speed.
Safety Planes	Defines planes, in space, that limit robot position. Safety planes limit either the tool/end effector alone or both the tool/end effector and the elbow.
Tool Orientation	Defines allowable orientation limits for the tool.
Speed Limit	Limits maximum robot speed. The speed is limited at the elbow, at the tool/end effector flange, and at the center of the user-defined tool/end effector positions.
Force Limit	Limits maximum force exerted by the robot tool/end effector and elbow in clamping situations. The force is limited at the tool/end effector, elbow flange and center of the user-defined tool/end effector positions.
Momentum Limit	Limits maximum momentum of the robot.
Power Limit	Limits mechanical work performed by the robot.
Stopping Time Limit	Limits maximum time the robot uses for stopping after a protective stop is initiated.
Stopping Distance Limit	Limits maximum distance travelled by the robot after a protective stop is initiated.

#### Safety Function

When performing the application risk assessment, it is necessary to take into account the motion of the robot after a stop has been initiated. In order to ease this process, the safety functions *Stopping Time Limit* and *Stopping Distance Limit* can be used.

These safety functions dynamically reduces the speed of the robot motion such that it can always be stopped within the limits. The joint position limits, the safety planes and the tool/end effector orientation limits take the expected stopping distance travel into account i.e. the robot motion will slow down before the limit is reached.

The functional safety can be summarized as:

\*used same as UR10e (to verify)

Safety Function	Accuracy	Performance Level	Category
Emergency Stop	-	d	3
Safeguard Stop	-	d	3
Joint Position Limit	5 °	d	3
Joint Speed Limit	1.15 °/s	d	3
Safety Planes	40 mm	d	3
Tool Orientation	3 °	d	3
Speed Limit	50 mm/s	d	3
Force Limit	25 N	d	3
Momentum Limit	3 kg m/s	d	3
Power Limit	10 W	d	3
Stopping Time Limit	50 ms	d	3
Stopping Distance Limit	40 mm	d	3
Safe Home	1.7 °	d	3

## Warnings



### CAUTION

Failure to configure the maximum speed limit can result in hazardous situations.

- If the robot is used in manual hand-guiding applications with linear movements, the speed limit must be set to maximum 250 mm/s for the tool/end effector and elbow unless a risk assessment shows that higher speeds are acceptable. This will prevent fast movements of the robot elbow near singularities.



### NOTICE

There are two exceptions to the force limiting function that are important when designing an application.

As the robot stretches out, the knee-joint effect can give high forces in the radial direction (away from the base) at low speeds. Similarly, the short leverage arm, when the tool/end effector is close to the base and moving around the base, can cause high forces at low speeds.

## 10.2.4. Safety Functions

**Description** The safety system acts by monitoring if any of the safety limits are exceeded or if an Emergency Stop or a Safeguard Stop is initiated.

The reactions of the safety system are:

Trigger	Reaction
Emergency Stop	Stop Category 1
Safeguard Stop	Stop Category 2
3PE Stop (if a 3-Position Enabling device is connected)	Stop Category 2
Limit Violation	Stop Category 0
Fault Detection	Stop Category 0



**NOTICE**

If the safety system detects any fault or violation, all safety outputs reset to low.

## 10.2.5. Safety Parameter Set

---

- Description** The safety system has the following set of configurable safety parameters:
- Normal
  - Reduced
- 

- Normal and Reduced** You can set up the safety limits for each set of safety parameters, creating distinct configurations for normal, or higher settings, and reduced. The reduced configuration is active when the tool/end effector is positioned on the reduced side of a Trigger Reduced Plane, or when the reduced configuration is externally triggered by a safety input.
- Using a plane to trigger the Reduced configuration:** When the robot arm moves from the side of the trigger plane configured with reduced safety parameters, to the side that is configured with normal safety parameters, there is a 20 mm area around the trigger plane where both normal and reduced limits are allowed. This area around the trigger plane prevents nuisance safety stops when the robot is exactly at the limit.
- Using an input to trigger the Reduced configuration:** When a safety input starts, or stops, the reduced configuration, up to 500 ms can elapse before the new limit values become active. This can happen in either of the following circumstances:
- Switching from the reduced configuration to normal
  - Switching from the normal configuration to reduced

The robot arm adapts to the new safety limits within the 500 ms.

---

## Recovery

When a safety limit is exceeded, the safety system must be restarted. For example, if a joint position limit is outside a safety limit, at start-up, Recovery is activated.

You cannot run programs for the robot when recovery is activated, but the robot arm can be manually moved back within limits using Freedrive, or by using the Move tab in PolyScope.

The safety limits for Recovery are:

Safety Function	Limit
Joint Speed Limit	30 °/s
Speed Limit	250 mm/s
Force Limit	100 N
Momentum Limit	10 kg m/s
Power Limit	80 W

The safety system issues a Stop Category 0 if a violation of these limits appears.



### WARNING

Failure to use caution when moving the robot arm in recovery mode can lead to hazardous situations.

- Use caution when moving the robot arm back within the limits, as limits for the joint positions, the safety planes, and the tool/end effector orientation are all disabled in recovery mode.

## 10.3. Software Safety Configuration

---

**Description** This section covers how to access the robot safety settings. It is made up of items that help you set up the robot Safety Configuration.



### WARNING

Before you configure your robot safety settings, your integrator must conduct a risk assessment to guarantee the safety of personnel and equipment around the robot. A risk assessment is an evaluation of all work procedures throughout the robot lifetime, conducted in order to apply correct safety configuration settings. You must set the following in accordance with the risk assessment.

1. The integrator must prevent unauthorized persons from changing the safety configuration e.g. installing password protection.
2. Use and configuration of the safety-related functions and interfaces for a specific robot application.
3. Safety configuration settings for set-up and teaching before the robot arm is powered on for the first time.
4. All safety configuration settings accessible on this screen and sub-tabs.
5. The integrator must ensure that all changes to the safety configuration settings comply with the risk assessment.

**Accessing Software Safety Settings**

Safety Settings are password protected and can only be configured once a password is set and subsequently used.

**To access the software safety settings**

1. In your PolyScope header, tap the **Installation** icon.
2. In the Side Menu on the left of the screen, tap **Safety**.
3. Observe that the **Robot Limits** screen displays, but settings are inaccessible.
4. If a **Safety password** was previously set, enter the password and press **Unlock** to make settings accessible. Note: Once Safety settings are unlocked, all settings are now active.
5. Press **Lock** tab or navigate away from the Safety menu to lock all Safety item settings again.

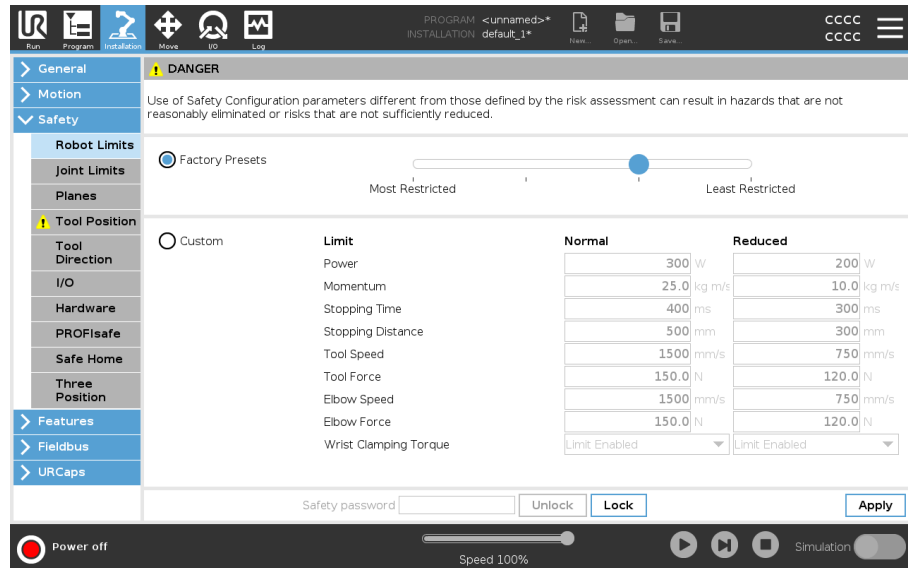

### 10.3.1. Changing the Software Safety Configuration

---

**Description** Changes to the Safety Configuration settings must comply with the risk assessment conducted by the integrator.

---

**Recommended procedure for the integrator:** To change the safety configuration

1. Verify that changes comply with the risk assessment conducted by the integrator.
2. Adjust safety settings to the appropriate level defined by the risk assessment conducted by the integrator.
3. Verify that the settings are applied.
4. Place following text in the operators' manuals:

Before working near the robot, make sure that the safety configuration is as expected. This can be verified e.g. by inspecting the Safety Checksum in the top right corner of PolyScope for any changes.

---

### 10.3.2. Applying a New Software Safety Configuration

---

**Description** The robot is powered off while you make changes to the configuration. Your changes only take effect after you tap the **Apply** button. The robot cannot be powered on again until you select **Apply and Restart** to visually inspect your robot Safety Configuration which, for safety reasons, is displayed in SI Units in a popup. You can select **Revert Changes** to return to the previous configuration. When your visual inspection is complete you can select **Confirm Safety Configuration** and the changes are automatically saved as part of the current robot installation.

---

## Safety Checksum

**Description** The **Safety Checksum** icon displays your applied robot safety configuration.



It could be four or eight digits.

A four-digit Checksum should be read from top to bottom and left to right, while an eight-digit Checksum is read left to right, top row first. Different text and/or colors indicate changes to the applied safety configuration.

The **Safety Checksum** changes if you change the **Safety Functions** settings, because the **Safety Checksum** is only generated by the safety settings.

You must apply your changes to the **Safety Configuration** for the **Safety Checksum** to reflect your changes.

### 10.3.3. Safety Configuration without Teach Pendant

**Description** You can use the robot without attaching the Teach Pendant. Removing the Teach Pendant requires defining another Emergency Stop source. You must specify if the Teach Pendant is attached to avoid triggering a safety violation.



**CAUTION**

If the Teach Pendant is detached or disconnected from the robot, the Emergency Stop button is no longer active. You must remove the Teach Pendant from the vicinity of the robot.

**To safely remove the Teach Pendant** The robot can be used without PolyScope as the programming interface.

To configure the robot without a Teach Pendant

1. In the Header tap **Installation**.
2. In the Side Menu on left tap **Safety** and select **Hardware**.
3. Input Safety password and **Unlock** the screen.
4. Deselect **Teach Pendant** to use robot without PolyScope interface.
5. Press **Save and restart** to implement changes.

## 10.3.4. Software Safety Modes

### Description

Under normal conditions, i.e. when no protective stop is in effect, the safety system operates in a Safety Mode associated with a set of safety limits.

- **Normal** is the safety configuration that is active by default
- **Reduced** is the safety configuration that is active when the robot **Tool Center Point** (TCP) is positioned beyond a Trigger Reduced plane, or when triggered using a configurable input.
- **Recovery mode** activates when a safety limit from the active limit set is violated, the robot arm performs a Stop Category 0.

If an active safety limit, such as a joint position limit or a safety boundary, is in violation when the robot arm is powered on, the robot arm starts up in recovery mode. This makes it possible to move the robot arm back within the safety limits.

In Recovery mode, the movement of the robot arm is restricted by a fixed limit that you cannot customize.



#### WARNING

Limits for **joint position**, **tool position** and **tool orientation** are disabled in Recovery mode, so take caution when moving the robot arm back within the limits.

The menu of the Safety Configuration screen enables the user to define separate sets of safety limits for both configurations: Normal and Reduced. For the tool and joints, reduced limits for speed and momentum are required to be more restrictive than their Normal mode counterparts.

### To Switch Modes: PolyScope

1. In the Header, select the profile icon.
  - **Automatic** indicates the operational mode of the robot is set to Automatic.
  - **Manual** indicates the operational mode of the robot is set to Manual.

### Using the Dashboard Server

1. Connect to the Dashboard server.
2. Use the **Set Operational Mode** commands.
  - Set Operational Mode Automatic
  - Set Operational Mode Manual
  - Clear Operational Mode

### 10.3.5. Software Safety Limits

**Description** The safety system limits are defined in the Safety Configuration . The safety system receives values from the input fields and detects any violation if any the values are exceeded. The robot controller prevents violations by making a robot stop or by reducing the speed.

## Robot Limits

**Description** Robot Limits restrict general robot movements. The Robot Limits screen has two configuration options: **Factory Presets** and **Custom**.

**Factory Presets** Factory Presets is where you can use the slider to select a predefined safety setting . The values in the table are updated to reflect the preset values ranging from **Most Restricted** to **Least Restricted**



**NOTICE**

Slider values are only suggestions and do not substitute a proper risk assessment.

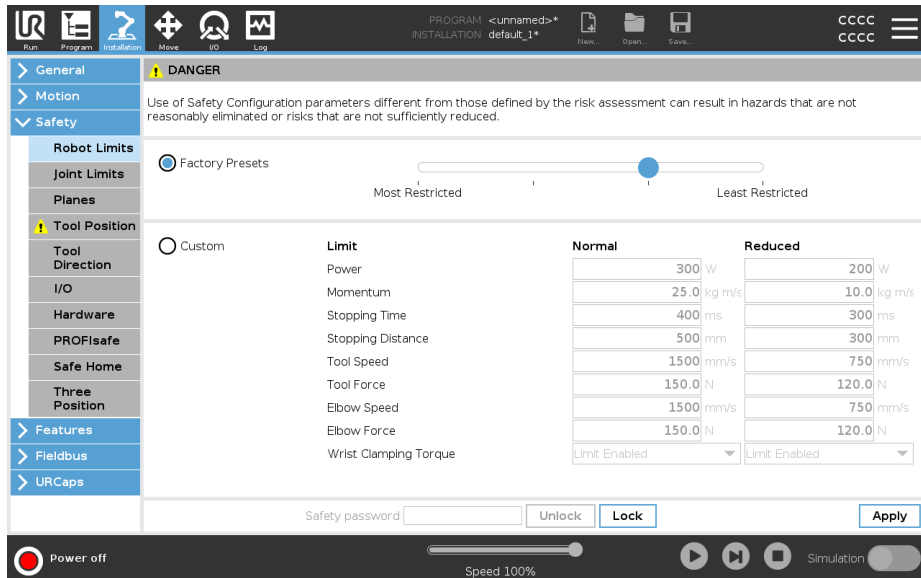

**Custom** Custom is where you can set Limits on how the robot functions and monitor the associated Tolerance.

Power	Limits maximum mechanical work produced by the robot in the environment. This limit considers the payload a part of the robot and not of the environment.
Momentum	Limits maximum robot momentum.
Stopping Time	Limits maximum time it takes the robot to stop e.g. when an emergency stop is activated.
Stopping Distance	<p>Limits maximum distance the robot tool or elbow can travel while stopping.</p> <div style="border: 1px solid #ccc; padding: 10px; margin-top: 10px;">  <p><b>NOTICE</b> Restricting stopping time and distance affect overall robot speed. For example, if stopping time is set to 300 ms, the maximum robot speed is limited allowing the robot to stop within 300 ms.</p> </div>
Tool Speed	Limits maximum robot tool speed.
Tool Force	Limits maximum force that the robot tool exerts on the environment to prevent clamping situations.
Elbow Speed	Limits maximum robot elbow speed.
Elbow Force	Limits maximum force that the elbow exerts on the environment to prevent clamping situations.

The tool speed and force are limited at the tool flange and the center of the two user-defined tool positions.

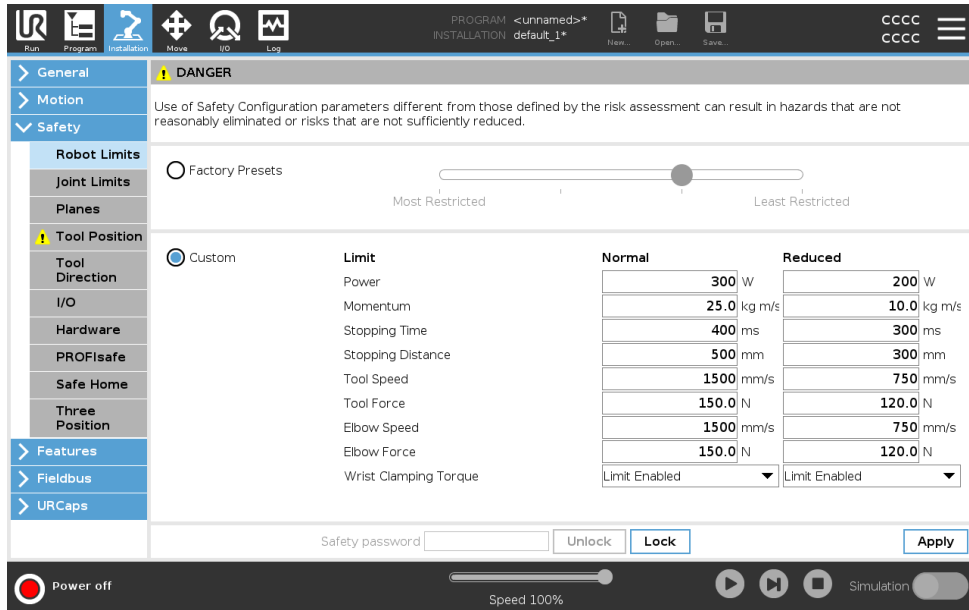

**NOTICE**

You can switch back to **Factory Presets** for all robot limits to reset to their default settings.

**Joint Limits**

**Description**

Joint limits allow you to restrict individual robot joint movements in joint space i.e. joint rotational position and joint rotational speed. Joint limiting can also be called software based axis limiting. The joint limit options are: **Maximum speed** and **Position range**.

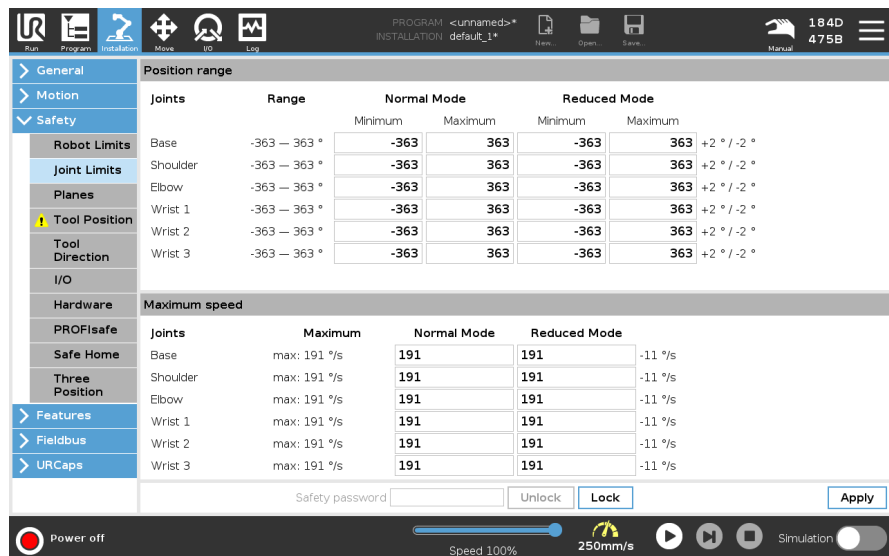

## 10.3.6. Safe Home Position

### Description

Safe Home is a return position defined by using the user-defined Home Position. Safe Home I/Os are active when the Robot Arm is in the Safe Home Position and a Safe Home I/O is defined.

The Robot Arm is in the Safe Home Position if the joint positions are at the specified joint angles or a multiple of 360 degrees thereof.

The Safe Home Safety Output is active when the robot is standing still at the Safe Home Position.

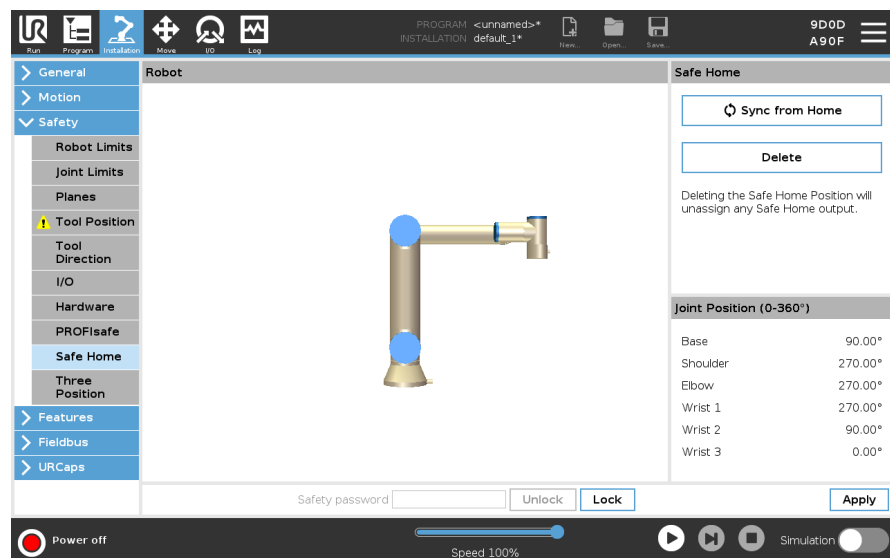

### Syncing from Home

To sync from Home

1. In the Header, tap **Installation**.
2. In the Side Menu on the left of the screen, tap **Safety** and select **Safe Home**.
3. Under **Safe Home**, tap **Sync from Home**.
4. Tap **Apply** and in the dialog box that appears, select **Apply and restart**.

### Safe Home Output

The Safe Home Position must be defined before the Safe Home Output.

### Defining Safe Home Output

To define Safe Home Output

1. In the Header, tap **Installation**.
2. In the Side Menu on the left of the screen, under **Safety**, select **I/O**.
3. On the I/O screen in the Output Signal, under Function Assignment, in drop-down menu, select **Safe Home**.
4. Tap **Apply** and in the dialog box that appears, select **Apply and restart**.



### Editing Safe Home

To edit Safe Home

Editing Home does not automatically modify a previously defined Safe Home position. While these values are out of sync, Home program node is undefined.

1. In the Header, tap **Installation**.
  2. In the Side Menu on the left of the screen, under **General**, select **Home**.
  3. Tap **Edit Position** and set the new robot arm position and tap **OK**.
  4. In the Side Menu, under **Safety**, select **Safe Home**. You need a Safety password to **Unlock** the Safety Settings.
  5. Under **Safe Home**, tap **Sync from Home**
-

## 10.4. Software Safety Restrictions

### Description



#### NOTICE

Configuring planes is entirely based on features. We recommend that you create and name all features before editing the safety configuration, as the robot is powered off once the Safety Tab has been unlocked, making it impossible to move the robot.

Safety planes restrict robot workspace. You can define up to eight safety planes, restricting the robot tool and elbow. You can also restrict elbow movement for each safety plane and disable it by deselecting the checkbox. Before configuring safety planes, you must define a feature in the robot installation. The feature can then be copied into the safety plane screen and configured.











#### WARNING

Defining safety planes only limits the defined Tool spheres and elbow, not the overall limit for the robot arm. This means that specifying a safety plane, does not guarantee that other parts of the robot arm will obey this restriction.

### Safety Planes Modes

You can configure each plane with restrictive **Modes** using the icons listed below.

	Disabled	The safety plane is never active in this state.
	Normal	When the safety system is Normal , a normal plane is active and it acts as a strict limit on the position.
	Reduced	When the safety system is Reduced, a reduced plane is active, acting s as a strict limit on the position.
	Normal & Reduced	When the safety system is either normal or reduced, a normal and reduced plane is active and acts as a strict limit on the position.
	Trigger Reduced	The safety plane causes the safety system to switch to Reduced if the robot Tool or Elbow is positioned beyond it.
	Show	Pressing this icon hides or shows the safety plane in the graphics pane.
	Delete	Deletes the created safety plane. There is no undo/redo action. If a plane is deleted in error, it must be remade.
	Rename	Pressing this icon allows you to rename the plane.

### Configuring safety planes

1. In your PolyScope header, tap **Installation**.
2. In the Side Menu on the left of the screen, tap Safety and select **Planes**.
3. On the top right of the screen, in the Planes field, tap **Add plane**.
4. On the bottom right of the screen, in the **Properties** field, set up Name, Copy Feature and Restrictions.

### Copy Feature

In **Copy Feature**, only Undefined and Base are available. You can reset a configured safety plane by selecting **Undefined**. If the copied feature is modified in the Features screen, a warning icon appears to the right of the Copy Feature text. This indicates that the feature is out of sync i.e. the information in the properties card is not updated to reflect the modifications that may have been made to the Feature.

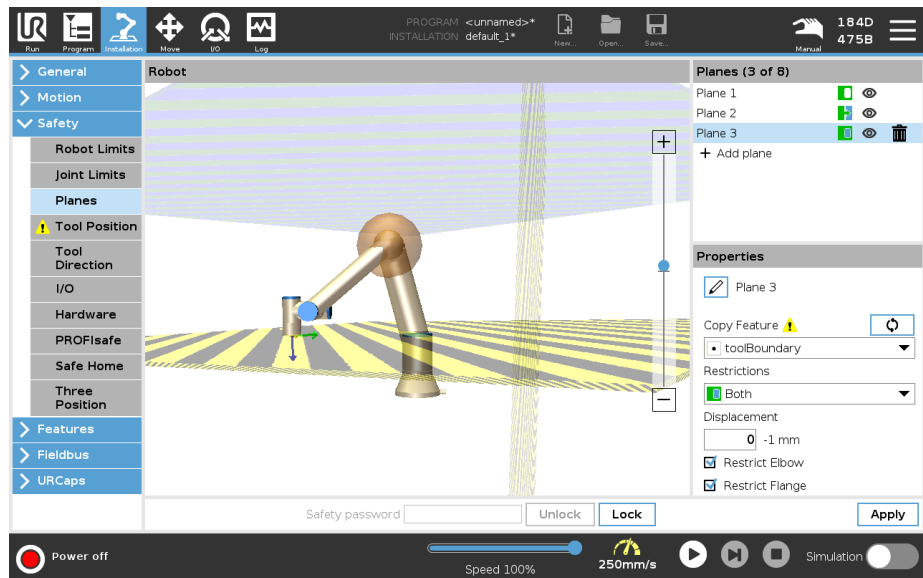

**Color Codes**

<i>Gray</i>	Plane is configured but disabled (A)
<i>Yellow &amp; Black</i>	Normal Plane (B)
<i>Blue &amp; Green</i>	Trigger Plane (C)
<i>Black Arrow</i>	The side of the plane the tool and/or elbow is allowed to be on (For Normal Planes)
<i>Green Arrow</i>	The side of the plane the tool and/or elbow is allowed to be on (For Trigger Planes)
<i>Gray Arrow</i>	The side of the plane the tool and/or elbow is allowed to be on (For Disabled Planes)

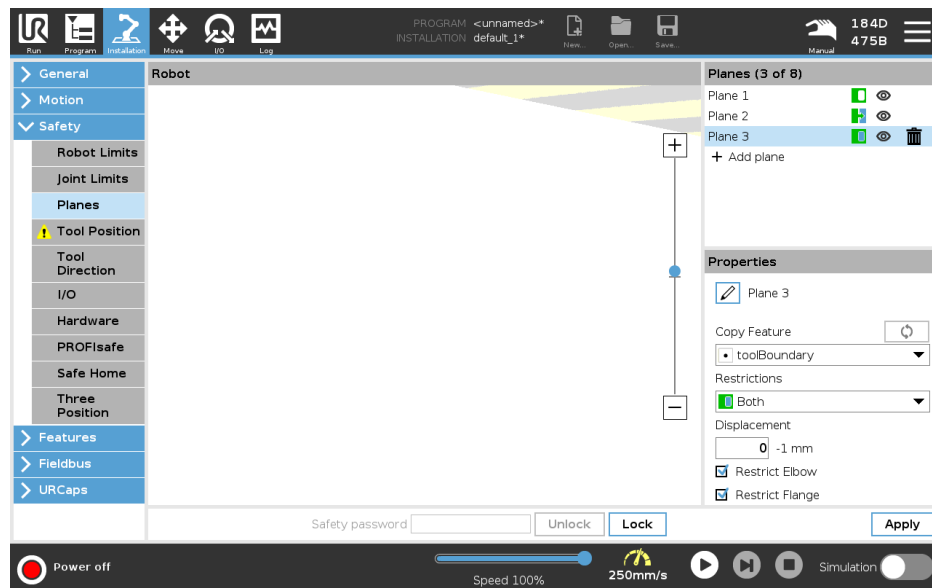

**Elbow Restriction**

You can enable **Restrict Elbow** to prevent robot elbow joint from passing through any of your defined planes. Disable Restrict Elbow for elbow to pass through planes. The diameter of the ball that restricts the elbow is different for each size of robot.

UR3e	0.1 m
UR5e	0.13 m
UR10e / UR16e	0.15 m
UR15	0.15 m
UR20 / UR30	0.19 m

The information about the specific radius can be found in the *urcontrol.conf* file on the robot under the section [Elbow].

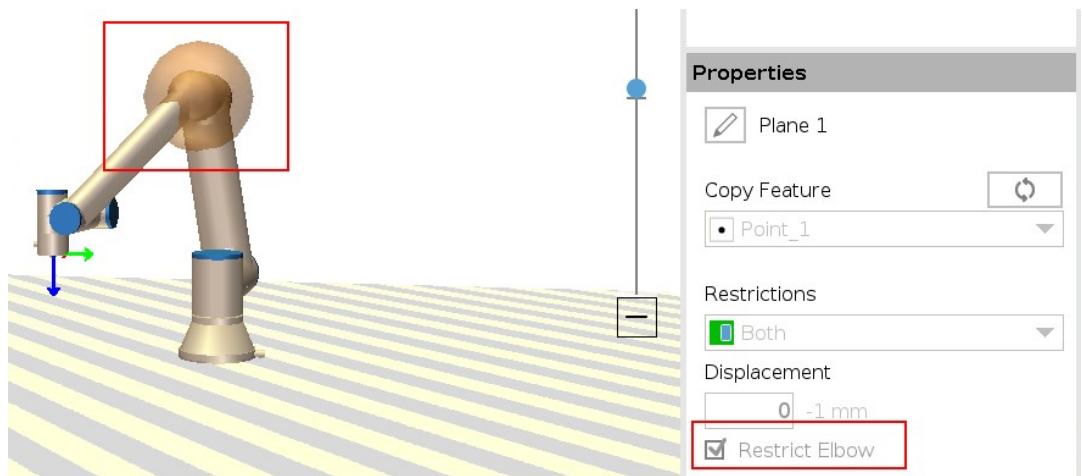

**Tool Flange Restriction**

Restricting the tool flange prevents the tool flange and the attached tool from crossing a safety plane. When you restrict the tool flange, the unrestricted area is the area inside of the safety plane, where the tool flange can operate normally. The tool flange cannot cross the restricted area, outside of the safety plane.

Removing the restriction allows the tool flange to go beyond the safety plane, to the restricted area, while the attached tool remains inside of the safety plane.

You can remove the tool flange restriction when working with a large tool off-set. This will allow extra distance for the tool to move.

Restricting the tool flange requires the creation of a plane feature. The plane feature is used to set up a safety plane later in the safety settings.

**Adding a plane feature example**

Displacement offsets the plane in either the positive or negative direction along the plane normal (Z-axis of the plane feature). Deselect the checkbox for the Elbow and the Tool Flange so they do not trigger the safety plane. The Elbow can remain checked as needed by your application.

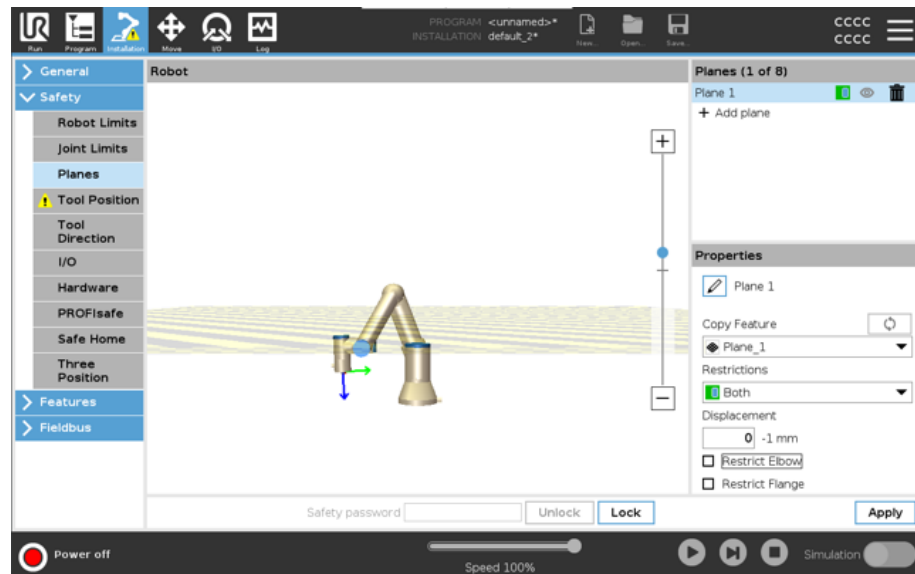

The unrestricted tool flange can cross a safety plane, even when no tool is defined. If no tool is added, a warning on the Tool Position button prompts you to correctly define the tool. When working with an unrestricted tool flange and a defined tool, it is ensured that the dangerous part of the tool can't go above and/or beyond certain area. The unrestricted tool flange can be used for any application where safety planes are needed, like Welding or Assembly.

**Tool flange restriction example**

In this example, an X-Y-plane is created with an offset of 300mm along the positive Z-axis with reference to the base feature.

The Z-axis of the plane can be thought of as “pointing” towards the restricted area. If the safety plane is needed on e.g., the surface of a table, rotate the plane 3.142 rad or 180° around either the X- or Y-axis so the restricted area is under the table. (TIP: Change the display of rotation from “Rotation Vector [rad]” to “RPY [°]”)

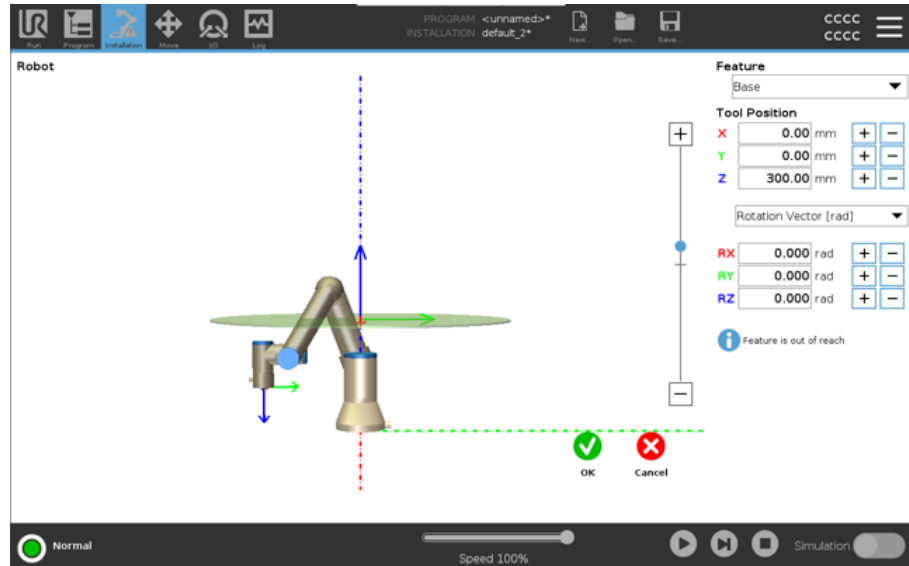

If needed it is possible to offset the plane in either positive or negative Z-direction later in the safety settings.

When satisfied with the position of the plane, tap OK.

## 10.4.1. Tool Direction Restriction

### Description

The Tool Direction screen can be used to restrict the angle in which the tool is pointing. The limit is defined by a cone that has a fixed orientation with respect to the robot arm Base. As the robot arm moves around, tool direction is restricted so it remains within the defined cone. The default direction of the tool coincides with the Z-axis of the tool output flange. It can be customized by specifying tilt and pan angles. Before configuring the limit, you must define a point or plane in the robot installation. The feature can then be copied and its Z axis used as the center of the cone defining the limit.



### NOTICE

Configuration of the tool direction is based on features. We recommend you create desired feature(s) before editing the safety configuration, as once the Safety Tab has been unlocked, the robot arm powers off making it impossible to define new features.

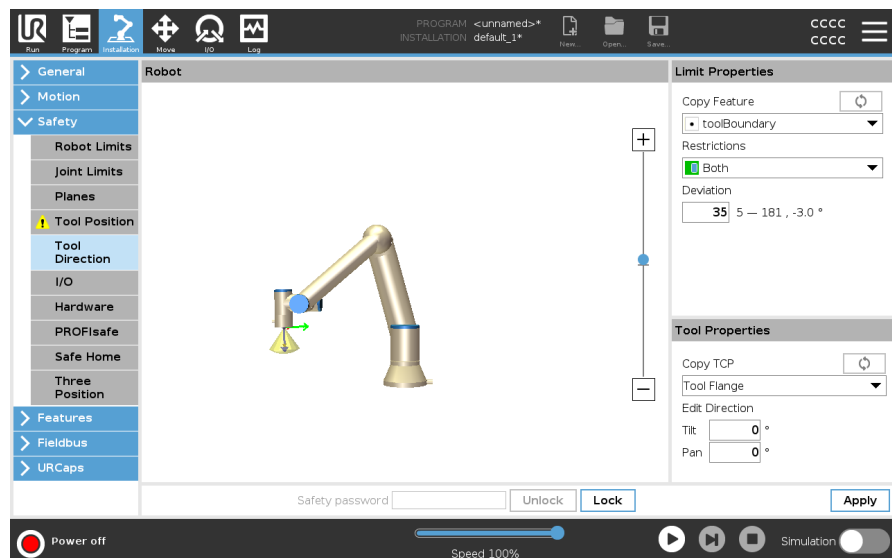

**Limit Properties**

The Tool Direction limit has three configurable properties:

1. **Cone center:** You can select a point or plane feature from the drop-down menu, to define the center of the cone. The Z axis of the selected feature is used as the direction around which the cone is centred.
2. **Cone angle:** You can define how many degrees the robot is allowed to deviate from center.

Disabled Tool direction limit	Never active
Normal Tool direction limit	Active only when safety system is in <b>Normal mode</b>
Reduced Tool direction limit	Active only when the safety system is in <b>Reduced mode</b>
Normal & Reduced Tool direction limit	Active when the safety system is in <b>Normal mode</b> as well as when it is in <b>Reduced mode</b> .

You can reset the values to default or undo the Tool Direction configuration by setting the copy feature back to "Undefined".

**Tool Properties**

By default, the tool points in the same direction as the Z axis of the tool output flange. This can be modified by specifying two angles:

- **Tilt angle:** How much to tilt the Z axis of the output flange towards the X axis of the output flange
- **Pan angle:** How much to rotate the tilted Z axis around the original output flange Z axis.

Alternatively, the Z axis of an existing TCP can be copied by selecting that TCP from the drop-down menu.

---

## 10.4.2. Tool Position Restriction

### Description

The Tool Position screen enables more controlled restriction of tools and/or accessories placed on the end of the robot arm.

- **Robot** is where you can visualize your modifications.
- **Tool** is where you can define and configure a tool up to two tools.
- **Tool\_1** is the default tool defined with values  $x=0.0$ ,  $y=0.0$ ,  $z=0.0$  and  $radius=0.0$ . These values represent the robot tool flange.

Under Copy TCP, you can also select **Tool Flange** and cause the tool values to go back to 0.

A default sphere is defined at the tool flange.

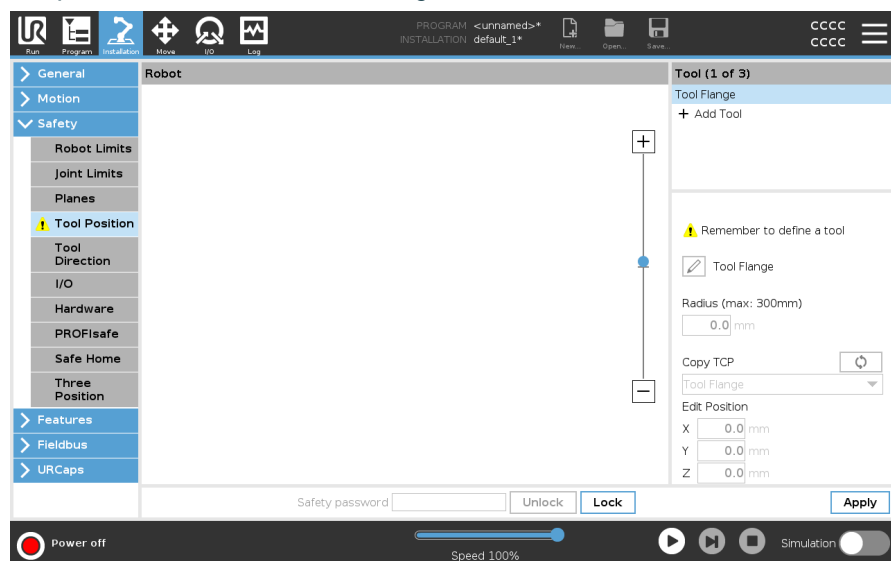

**User defined tools**

For the user defined tools, the user can change:

- **Radius** to change the radius of the tool sphere. The radius is considered when using safety planes. When a point in the sphere passes a reduced trigger plane, the robot switches to a Reduced configuration . The safety system prevents any point on the sphere from passing a safety plane.
- **Position** to change the position of the tool with respect to the tool flange of the robot. The position is considered for the safety functions for tool speed, tool force, stopping distance and safety planes.

You can use an existing Tool Center Point as a base for defining new tool positions. A copy of the existing TCP, predefined in General menu, in TCP screen, can be accessed in Tool Position menu, in Copy TCP drop-down list.

When you edit or adjust the values in the **Edit Position** input fields, the name of the TCP visible in the drop down menu changes to **custom**, indicating that there is a difference between the copied TCP and the actual limit input. The original TCP is still available in the drop down list and can be selected again to change the values back to the original position. The selection in the copy TCP drop down menu does not affect the tool name.

Once you apply your Tool Position screen changes, if you try to modify the copied TCP in the TCP configuration screen, a warning icon appears to the right of the Copy TCP text. This indicates that the TCP is out of sync i.e. the information in the properties field is not updated to reflect modifications that may have been made to the TCP. The TCP can be synced by pressing the sync icon.

The TCP does not have to be synced in order to define and use a tool successfully.

You can rename the tool by pressing the pencil tab next to the displayed tool name. You can also determine the Radius with an allowed range of 0-300 mm. The limit appears in the graphics pane as either a point or a sphere depending on radius size.

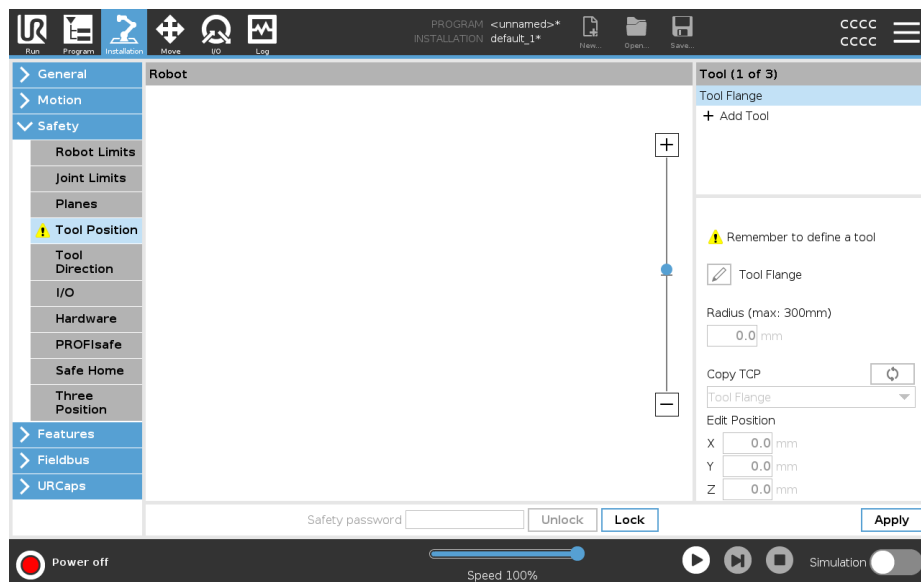

**Tool Position Warning** You must set a Tool Position within the safety settings, for the safety plane to trigger correctly when the tool TCP approaches the safety plane.  
The warning remains on the Tool Position if:

- You fail to add a new tool under Tool Flange.

To configure the tool position

1. In the Header tap **Installation**.
  2. On the left side of the screen, under Safety, tap **Tool Position**.
  3. On the right side of the screen, select **Add Tool**.
    - The newly added tool has a default name: **Tool\_x**.
  4. Tap the edit button to rename **Tool\_x** to something more identifiable.
  5. Edit the Radius and Position to match that of the tool you are currently using, or use the Copy TCP drop-down and choose a TCP from the General>TCP settings if such is defined.
-

**Tool Position Warning example** In this example, a Radius of 0.8mm is set and the TCP position to XYZ [20, 0, 400] in millimeters respectively. Optionally you can choose to "Copy TCP" by using the drop-down menu if one has already been set in the ->General/TCP settings. Once the Apply is tapped in the bottom right corner of the screen, you are DONE.

The warning on the Tool Position button indicates a tool is not added under Tool Flange.

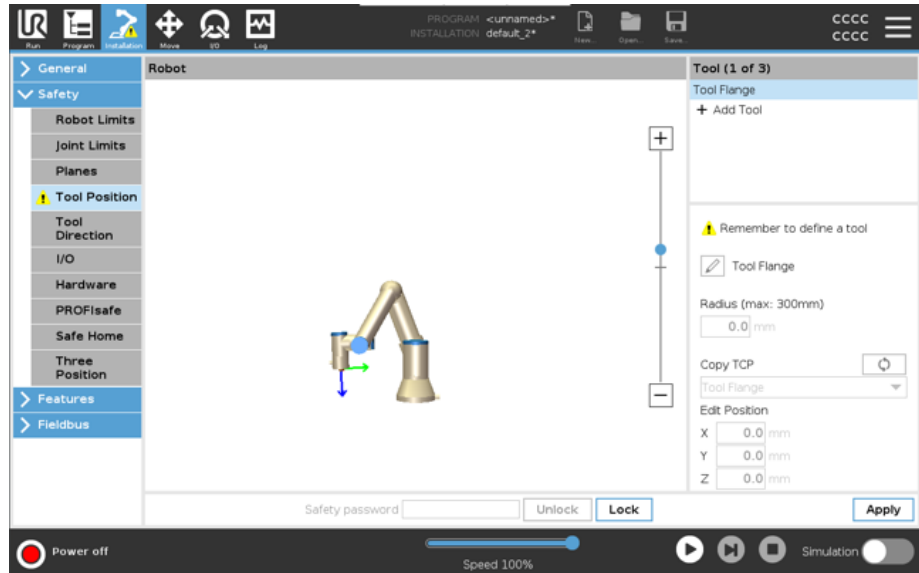

Tool Position button without the warning indicates a tool (other than the Tool Flange) is added.

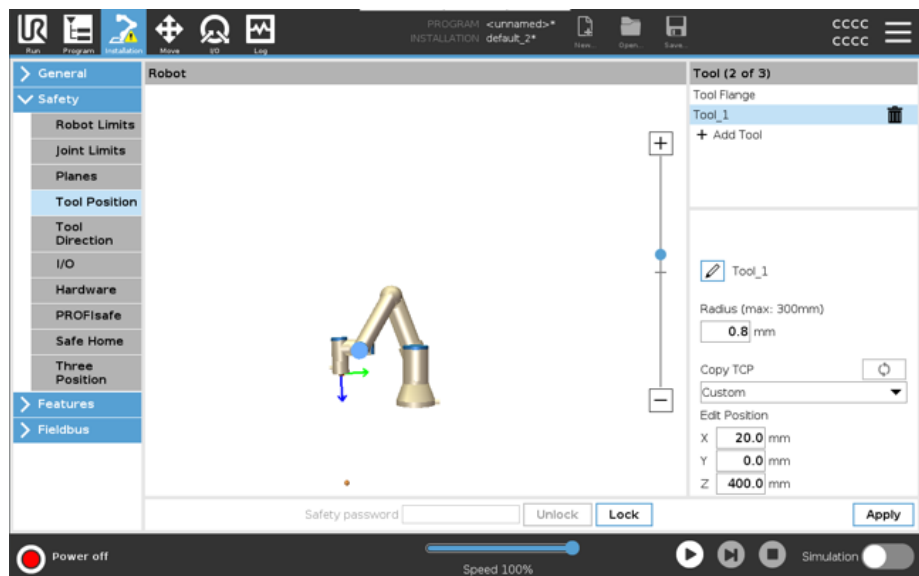

Copyright © 2009-2025 by Universal Robots A/S. All rights reserved.

# 11. The First Program

---

## Description

A program is a list of commands telling the robot what to do. For most tasks, programming is done entirely using the PolyScope software. PolyScope allows you to teach the robot arm how to move using a series of waypoints to set up a path for the robot arm to follow.

Use the Move tab to move the Robot Arm to a desired position, or teach the position by pulling the Robot Arm into place while holding down the Freedrive button at the top of the Teach Pendant.

You can create a program can to send I/O signals to other machines at certain points in the robot's path, and perform commands like **if...then** and **loop**, based on variables and I/O signals.

**To create a simple program**

This is a simple example program, to show how easy it is to use a UR robot. It assumes a harmless environment and a very careful user. Do not increase the speed or acceleration above the default values. Always conduct a risk assessment before placing the robot into operation.

1. On PolyScope, in the Header **File Path**, tap **New...** and select **Program**.
2. Under Basic, tap **Waypoint** to add a waypoint to the program tree. A default MoveJ is also added to the program tree.
3. Select the new waypoint and in the Command tab, tap **Waypoint**.
4. On the Move Tool screen, move the robot arm by pressing the move arrows. You can also move the robot arm by holding down the Freedrive button and pulling the Robot Arm into desired positions.
5. Once the robot arm is in position, press **OK** and the new waypoint displays as **Waypoint\_1**.
6. Follow steps 2 to 5 to create **Waypoint\_2**.
7. Select **Waypoint\_2** and press the Move Up arrow until it is above **Waypoint\_1** to change the order of the movements.
8. Stand clear, hold on to the emergency stop button and in the PolyScope Footer, press **Play** button for the Robot Arm to move between **Waypoint\_1** and **Waypoint\_2**. Congratulations! You have now produced your first robot program that moves the Robot Arm between the two given waypoints.

**NOTICE**

A singularity position can prevent the robot arm from moving into many poses/orientations and can block robot arm movement altogether.

- Avoid placing the robot arm into a singularity position

You can find more detailed information in the section on Singularity.

**NOTICE**

Do not drive the robot into itself or anything else as this may cause damage to the robot.

**WARNING**

Keep your head and torso outside the reach (workspace) of the robot. Do not place fingers where they can be caught.

## 11.1. Run Tab

### Description

The **Run** tab allows you to do simple operations and monitor the state of your robot. You can load, play, pause and stop a program, as well as monitor variables. The Run Tab is most useful when the program is created and the robot is ready for operation.

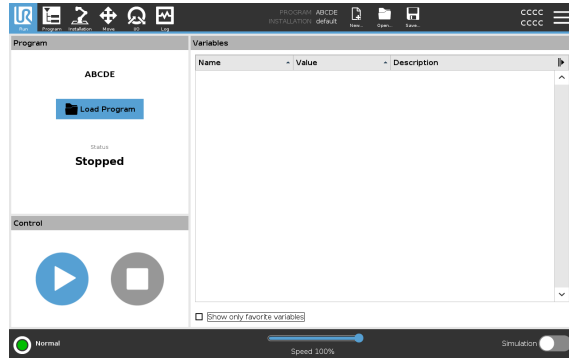

### Program

The Program pane displays the name and status of the current program.

### To load a new program

1. In the Program pane, tap **Load Program**.
2. Select your desired program from the list.
3. Tap **Open** to load the new program.

The variables, if present, are displayed when you play the program.

### Variables

The Variables pane displays the list of variables used by programs to store and update values during runtime.

- Program variables belong to programs.
- Installation variables belong to installations that can be shared among different programs. The same installation can be used with multiple programs.

All program variables and installation variables in your program are displayed in the Variables pane as a list showing the Name, Value and Description of the variable.

### Variable descriptions

You can add information to your variables by adding variable descriptions in the Description column. You can use the variable descriptions to convey the purpose of the variable and/or the meaning of its value to operators using the Run tab screen and/or other programmers.

Variable descriptions (if used) can be up to 120 characters, displayed in the Description column of the variables list on the Run tab screen and the Variables tab screen.

### Favorite variables

You can display selected variables by using the **Show only favorite variables** option. To show favorite variables

1. Under Variables, check the **Show only favorite variables** box.
2. Check **Show only favorite variables** again to show all variables.

You cannot designate favorite variables in the Run Tab, you can only display them. Designating favorite variables depends on the variable type.

### To designate favorite program variables

1. In the Header, tap **Program**.  
The variables are listed under **Variable Setup**.
2. Select the desired variables.
3. Check the **Favorite variable** box.
4. Tap **Run** to return to your variable display.



### To designate favorite installation variables

1. In the Header, tap **Installation**.
2. Under General, select **Variables**.  
The variables are listed under **Installation Variables**.
3. Select the desired variables.
4. Check the **Favorite variable** box.
5. Tap **Run** to return to your variable display.

### Collapse/expand the Description column

A variable description spans multiple lines to fit the width of the Description column if necessary. You can also collapse and expand the Description column by using the buttons shown below.

To collapse/expand the Description column

1. Tap  to collapse the Description column.
2. Tap  to expand the Description column.

### Collapsed Description column

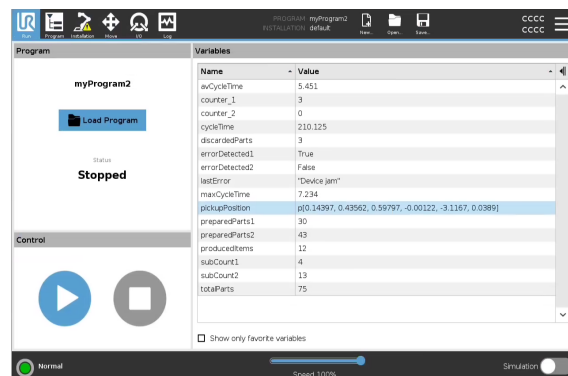

**Expanded Description column**

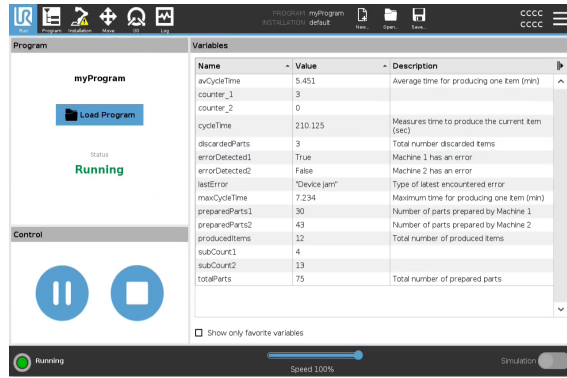

**Control** The Control pane allows you to control the running program. You can play and stop, or pause and resume a program, using the buttons listed in the table below:

- The Play button, Pause button and the Resume Button are combined.
- The Play button changes to Pause when the program is running.
- The Pause button changes to Resume.

Button	Function
	To play a program 1. Under Control, tap <b>Play</b> to start running a program from the beginning.
	To resume a paused program 1. Tap <b>Resume</b> to continue running the paused program.
	To stop a program 1. Tap <b>Stop</b> to stop the running program You cannot resume a stopped program. You can tap <b>Play</b> to restart the program.
	To pause a program 1. Tap <b>Pause</b> to pause a program at a specific point. You can resume a paused program.

## 11.2. Move Robot into Position

---

**Description** Access the **Move Robot into Position** screen when the Robot Arm must move to a particular start position before running a program, or when the Robot Arm is moving to a waypoint while modifying a program.

In cases where the **Move Robot into Position** screen cannot move the Robot Arm to the program start position, it moves to the first waypoint in the program tree.

The Robot Arm can move to an incorrect pose if:

- The TCP, feature pose or waypoint pose of the first movement is altered during program execution before the first move is executed.
  - The first waypoint is inside an If or Switch program tree node.
- 

**Accessing the Move Robot into Position Screen**

1. Tap the Run tab in the header.
2. In the **Footer**, tap **Play** to access the **Move Robot into Position** screen.
3. Follow the on-screen instructions to interact with the animation and the real robot.

**Move robot to** Hold down **Move robot to:** to move the Robot Arm to a start position. The animated Robot Arm displayed on-screen shows the desired movement about to be performed.



**NOTICE**

Collision can damage the robot or other equipment. Compare the animation with the position of the real Robot Arm to ensure the Robot Arm can safely perform the movement without colliding with any obstacles.

**Manual** Tap **Manual** to access the **Move** screen where the Robot Arm can be moved by using the Move Tool arrows and/or configuring Tool Position and Joint Position coordinates.

---

## 11.3. Using the Program Tab

### Description

The Program tab is the where you create and edit robot programs. There are two main areas:

- The left side contains the program nodes you can add to your robot program. You can use the Basic, Advanced and Template dropdowns to the very left.
- The right side contains the configuration of the program nodes you can add to your program. You can use Command, Graphics and Variables options.

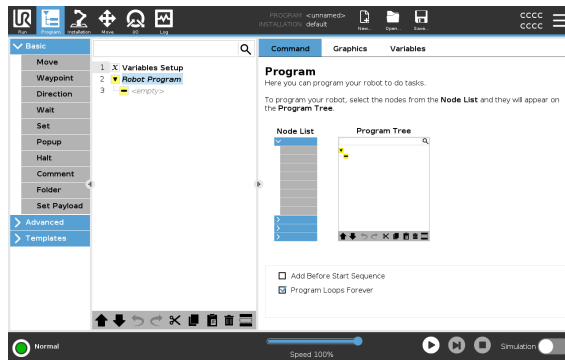

### Program Tree

The program tree is built as you add program nodes to your program. You can use the Command tab to configure the functionality of the added program nodes.

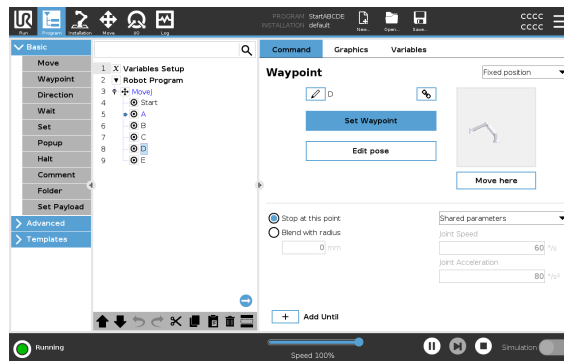

### Adding program nodes

- You cannot run an empty program tree or a program containing incorrectly configured program nodes.
- Incorrectly configured programs nodes are highlighted in yellow.
- Correctly configured program nodes are highlighted in white.

**Program Execution Indication**

You can follow the the flow of a long robot program by looking at the active program node.

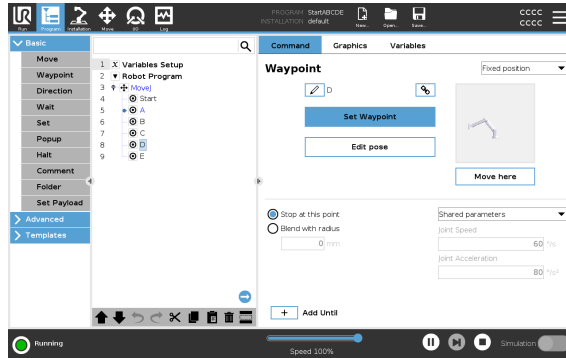

When the program is running, the program node currently being executed is indicated by a small icon next to that node.

The path of execution is highlighted with blue arrow .

Tapping the  icon at the corner of the program allows it to track the command being executed









**Search Button**

You can also search for a specific command/program node. This is useful when you have a long program with many different program nodes.

## 11.4. Program Tree Toolbar

**Description** You can work with the program nodes that have been added to the program tree by using the icons in the bottom of the program tree.

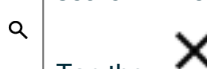
**Icons in the Program Tree toolbar** Use the toolbar at the base of the Program Tree to modify the Program Tree.

Undo & Redo		undo and redo changes to commands.
Move Up & Move Down		changes the position of a node.
Cut		cuts a node and allows it to be used for other actions (e.g., paste it on other place on the Program Tree).
Copy		copies a node and allows it to be used for other actions (e.g., paste it on other place on the Program Tree).
Paste		pastes a node that was previously cut or copied.
Delete		removes a node from the Program Tree.
Suppress		suppresses specific nodes on the Program Tree.
Search Button		search in the Program Tree. Tap the  icon to exit search.

## 11.5. Using Selected Program Nodes

**Description** You can start your robot program from any program node in the program tree. This is useful when you are testing your program.

When the robot is in Manual Mode you can allow a program to start from a selected node or you can start the entire program from the beginning.

**Play From Selection** The Play button in the Footer provides options for how to start the program. In the image below, the **Play** button is selected and **Play from Selection** is displayed.

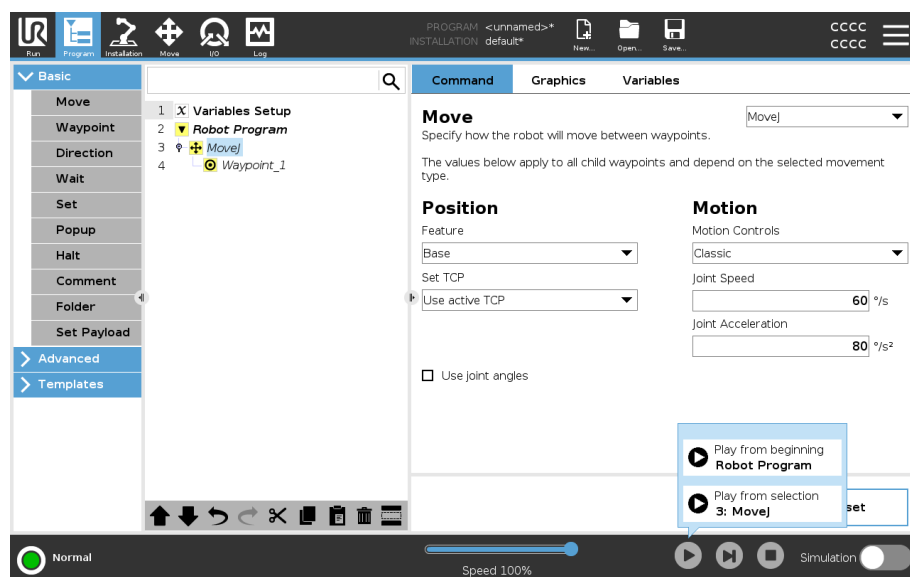

- You can start a program only from a node in the robot Program tree. The **Play from Selection** stops if a program cannot be run from a selected node. The program also stops and displays an error message if an unassigned variable is encountered while playing a program from selected node.
- You can use **Play from Selection** in a subprogram. The program execution halts when the subprogram ends.
- You cannot use **Play from Selection** with a thread because threads always start from the beginning.

**To play a program from a selected node**

1. In the Program tree, select a node.
2. In the Footer, tap **Play**.
3. Select **Play from Selection** to run a program from a node in the program tree.

**Example** You can start a stopped program again from a specific node.

## 11.6. Using Basic Program Nodes

---

**Description** Basic program nodes are used to create simple robot applications. Some basic program nodes are also used to organize your robot program and create comments in your robot program. This can be quite useful, if it is large robot program.

---

## 11.7. Basic Program Nodes: Move

---

**Description** The Move command allows the robot to move from point A to point B. How the robot moves is important to the task the robot is performing. When you add a Move to your program tree, the Move pane appears to the right of the screen. The options in the Move pane allow you to configure a Move and the attached waypoint.

---

**Speed settings** The shared parameters that apply to the movement types are the maximum joint speed and joint acceleration.

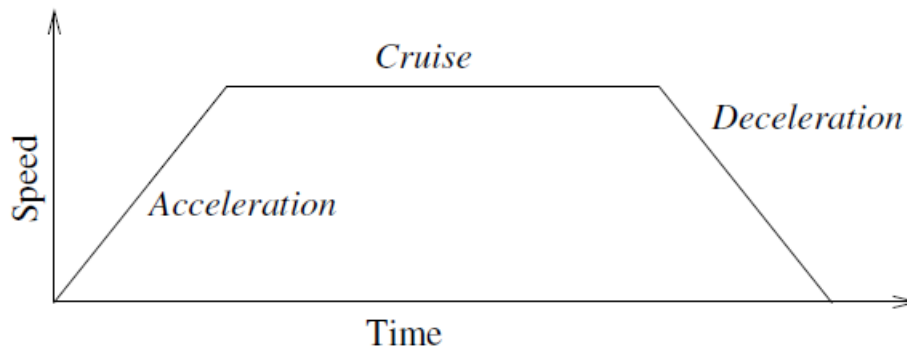

**1.1:** *Speed profile for a motion. The curve is divided into three segments: acceleration, cruise and deceleration. The level of the cruise phase is given by the speed setting of the motion, while the steepness of the acceleration and deceleration phases is given by the acceleration parameter.*

OptiMove is a motion control option that specifies the speed and acceleration of the robot, while maintaining hardware limits. This means the optimal motion of the robot does not exceed the desired limits.

So 100% is the maximum speed percentage and acceleration within the hardware limits.

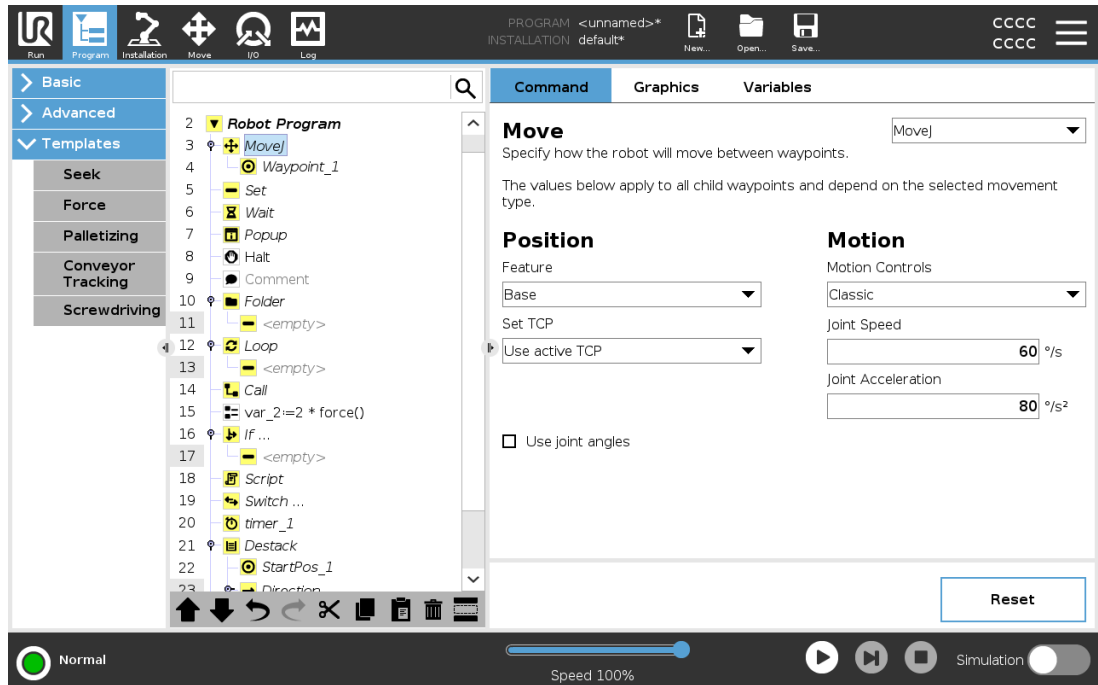

Copyright © 2009-2025 by Universal Robots A/S. All rights reserved.

**Move commands**

The Move command controls the robot's motion via waypoints. Waypoints are automatically added when you add Move commands to a program. You can also use Moves to set acceleration and speed for the robot arm's movement between waypoints.

The robot moves using four Move commands as described in the following sections:

- [MoveJ below](#)
- [MoveL on the facing page](#)
- [MoveP on the facing page](#)
- [MoveCircle on page 157](#)

**MoveJ**

The MoveJ command creates a movement from point A to point B that is optimal for the robot. The movement may not be a direct line between A and B, but optimal for the start position of the joints and the end position of the joints. MoveJ makes movements that are calculated in the robot arm joint space. Joints are controlled to finish their movements at the same time. This movement type results in a curved path for the tool to follow.

- To add a MoveJ**
1. In your robot program tree, select the place where you wish to add a Move.
  2. Under Basic, tap **Move** to add a Move node together with a waypoint.
  3. Select the move node.
  4. Select MoveJ in the drop-down menu.

- To add a MoveJ with OptiMove**
1. In your robot program tree, select the desired move node or waypoint node.
  2. In the Motion Controls dropdown menu, select **OptiMove**.
  3. Use the slider to set the speed.
  4. You can select **Scaled acceleration** to keep the settings linked.  
You can deselect **Scaled acceleration** to modify the settings independently .

**Using Use joint angles** The Use joint angles option is an alternative to the 3D pose when you are using MoveJ to define a waypoint.

Waypoints defined using the Use joint angle are not changed when a program is moved between robots. This is useful if you are installing your program in a new robot.

Using Use joint angles makes the TCP options and feature unavailable.

---

**MoveL** The MoveL command creates a movement that is a direct line from point A and point B. MoveL moves the Tool Center Point (TCP) linearly between waypoints. This means that each joint performs a more complicated motion to keep the tool on a straight line path.

- To add a MoveL** Adding a MoveL is similar to adding a MoveJ.
1. In your robot program tree, select the place where you wish to add the MoveL.
  2. Under Basic, tap Move and select MoveL from the drop-down menu.
- Adding a MoveL with OptiMove is also similar to adding a MoveJ with OptiMove. Once you select the node, simply navigate to the Motion Controls dropdown and select OptiMove.

---

**MoveP** The MoveP command creates a movement with a constant speed between the waypoints. Blend between waypoints is enabled to ensure constant speed.

- To add a MoveP** Adding a MoveP is similar to adding a MoveJ and a MoveL.
1. In your robot program tree, select the place where you wish to add the MoveP.
  2. Under Basic, tap Move and select MoveP from the drop-down menu.
- Adding a MoveP with OptiMove is also similar to adding a MoveJ with OptiMove. Once you select the node, simply navigate to the Motion Controls dropdown and select OptiMove.

**Detail**

MoveP moves the tool linearly with constant speed with circular blends, and is intended for some process operations, like gluing or dispensing. The size of the blend radius is by default a shared value between all the waypoints. A smaller value will make the path turn sharper whereas a higher value will make the path smoother. While the robot arm is moving through the waypoints with constant speed, the robot control box cannot wait for either an I/O operation or an operator action. Doing so might stop the robot arm's motion, or cause a robot stop.

**MoveCircle**

The MoveCircle command creates a circular movement, by creating a half circle. You can only add CircleMove via a MoveP command.

**To add a MoveCircle**

1. In your robot program tree, select the place where you wish to add a Move.
2. Under Basic, tap **Move**.  
A waypoint is added to the robot program together with the Move node.
3. Select the move node.
4. Select the MoveP from the drop-down menu.
5. Tap **Add circle move**
6. Select the orientation mode.

**Detail**

The robot starts the circular movement from its current position, or start point, and moves through a ViaPoint specified on the circular arc, to an EndPoint that completes the circular movement.

A mode is used to calculate tool orientation, through the circular arc.

The mode can be:

- Fixed: only the start point is used to define the tool orientation.
- Unconstrained: the start point transforms to the EndPoint to define tool orientation.

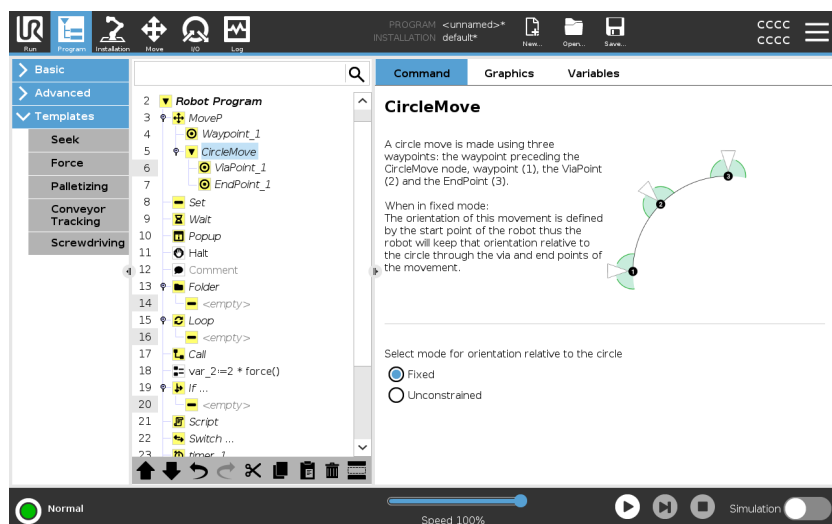

Copyright © 2009-2025 by Universal Robots A/S. All rights reserved.

**Using Set TCP** Use this setting, if you need to change TCP during the robot program execution. This is useful if you need to manipulate different objects in the robot program.  
The way the robot moves is adjusted depending on which TCP is set as an active TCP. **Ignore Active TCP** allows this movement to be adjusted in relation to the Tool Flange.

**To set the TCP in a Move**

1. Access the Program Tab screen to set the TCP used for waypoints.
2. Under Command, in the drop down menu on the right select the Move type.
3. Under Move, select an option in the **Set TCP** drop down menu.
4. Select **Use active TCP** or select **a user defined TCP**.  
You can also choose **Ignore Active TCP**.

---

**Feature** You can use Feature between waypoints for the program to remember the tool coordinates. This is useful when you are setting the waypoints (see [Features](#)).

You can use Feature in the following circumstances:

- Feature has no effect on relative waypoints. The relative movement is always performed with respect to orientation of the **Base**.
  - When the robot arm moves to a variable waypoint, the Tool Center Point (TCP) is calculated as the coordinates of the variable in the space of the selected feature. Therefore, the robot arm movement for a variable waypoint changes if another feature is selected.
  - You can change a feature's position while the program is running by assigning a pose to its corresponding variable.
-

**Shared Parameters in a Move Command**

The shared parameters in the bottom right corner of the Move screen apply to the movement from the previous position of the robot arm to the first waypoint under the command, and from there to each of the following waypoints. The Move command settings do not apply to the path going *from* the last waypoint under that Move command.

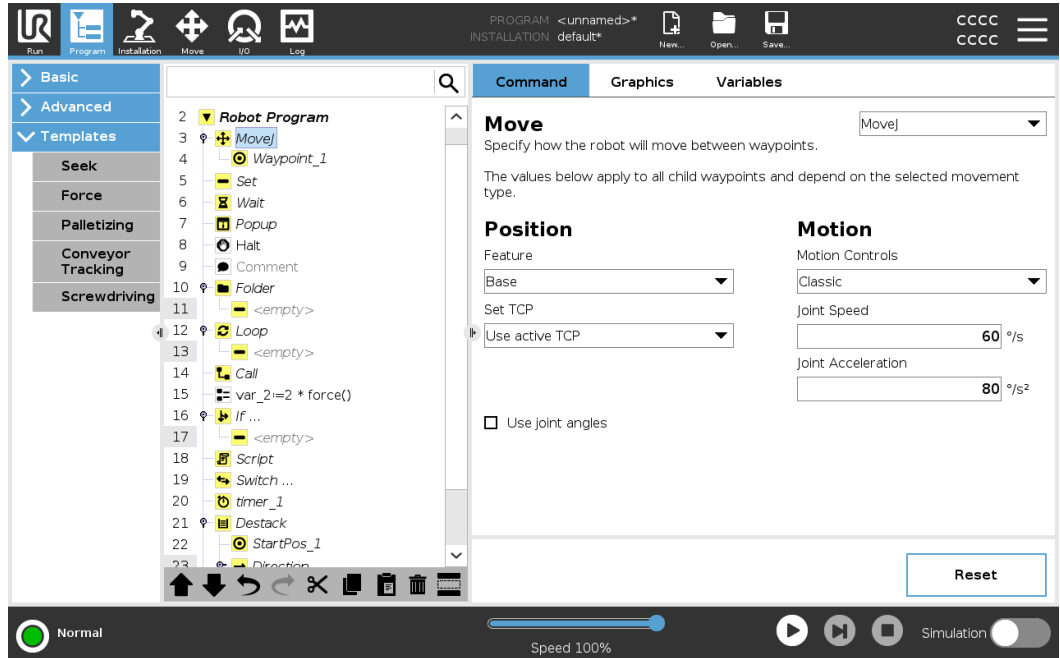

Copyright © 2009-2025 by Universal Robots A/S. All rights reserved.

## 11.8. Basic Program Nodes: Waypoints

**Description** Waypoints are one of the most central parts of a robot program, telling the robot arm where to go one movement at a time.

**Add Waypoints** A waypoint accompanies a Move, so adding a Move is required for the first waypoint.

- Add a waypoint to a robot program**
1. In your Robot Program, select the place where you wish to add a Move.
  2. Under Basic, tap **Move**.
- A waypoint is added to the robot program together with the Move node.

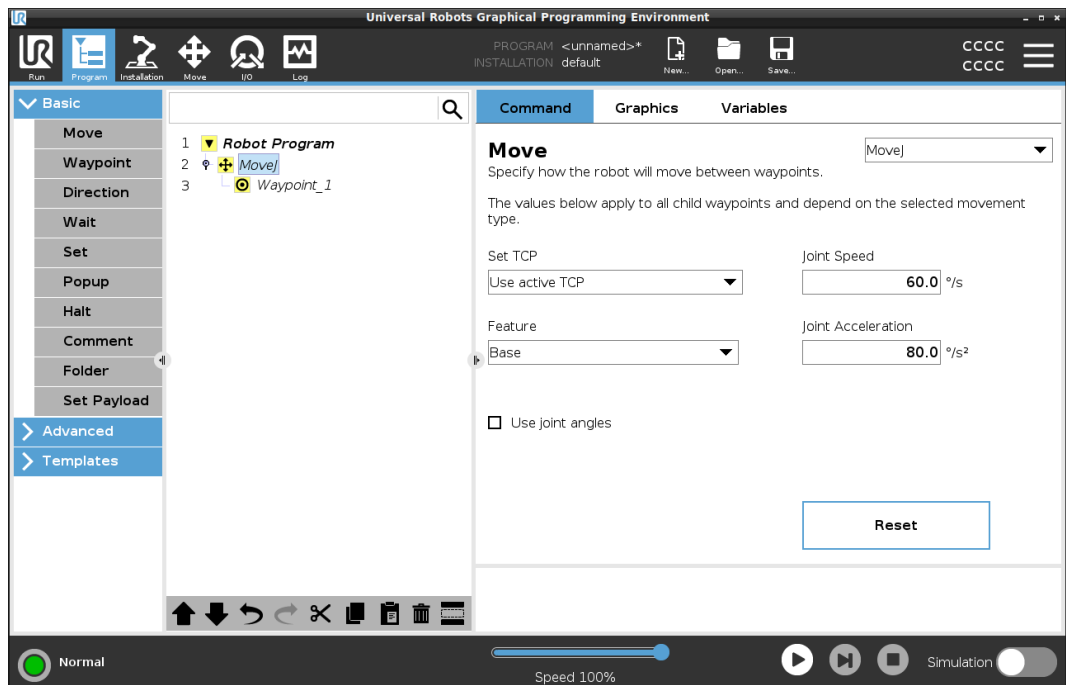

Copyright © 2009-2025 by Universal Robots A/S. All rights reserved.

**Add additional waypoints to a Move or Waypoint**

1. In your Robot Program, select a Move node or Waypoint node.
2. Under Basic, tap **Waypoint**.

The additional waypoint is added in the Move node. This waypoint is part of the Move command.

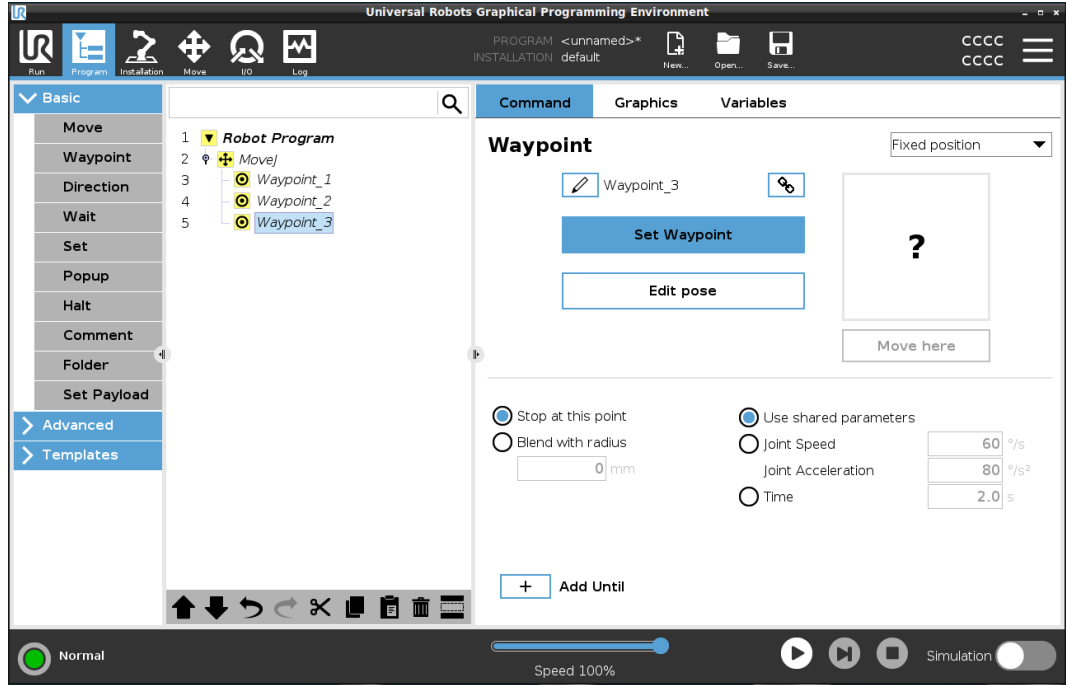

The additional waypoint is added under the waypoint that you selected in the robot program.

**Detail**

Using a waypoint means applying the taught relationship between the feature and the TCP from the Move command. The relationship between the feature and the TCP, applied to the current selected feature, achieves the desired TCP location. The robot calculates how to position the arm to allow the current active TCP to reach the desired TCP position.

## 11.9. Using the Move Tab

**Description** Use the Move Tab screen to move (jog) the robot arm directly, either by translating/rotating the robot tool, or by moving robot joints individually.

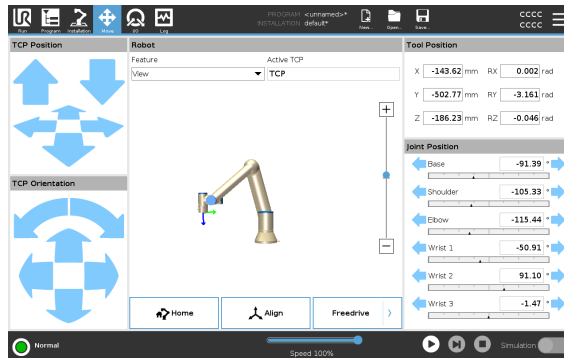

**To use the Move Tool arrows** Hold down any of the **Move Tool** arrows to move the robot arm in the corresponding direction.

- The **Translate arrows** (upper) move the tool flange in the direction indicated.
- The **Rotate arrows** (lower) change the orientation of the tool in the indicated direction. The rotation point is the Tool Center Point (TCP), i.e. the point at the end of the robot arm that gives a characteristic point on the tool. The TCP is shown as a small blue ball.

**Robot** If the current position of the TCP approaches a safety plane, a trigger plane, or the orientation of robot tool is near the tool orientation boundary limit, a 3D representation of the proximate boundary limit is shown. The visualization of boundary limits is disabled during program execution.

Safety planes display in yellow and black with an arrow indicating which side of the plane, the robot TCP is allowed to be positioned.

Trigger planes display in blue and green with an arrow indicating the side of the plane, where the **Normal** mode limits are active.

The tool orientation boundary limit is visualized with a spherical cone together with a vector indicating the current orientation of the robot tool. The inside of the cone represents the allowed area for the tool orientation (vector).

When the robot TCP is no longer in proximity of the limit, the 3D representation disappears. If the TCP is in violation or very close to violating a boundary limit, the visualization of the limit turns red.

**Feature** Under **Feature**, you can define how to control the robot arm relative to **View**, **Base** or **Tool** features. For the best feel for controlling the robot arm you can select the **View** feature, then use **Rotate arrows** to change the viewing angle of the 3D image to match your view of the real robot arm.

**Active TCP** In the **Robot** field, under **Active TCP**, the name of the current active Tool Center Point (TCP) is displayed.

---

**Home** The **Home** button accesses the **Move Robot into Position** screen, where you can hold down the **Auto** button to move robot into position previously defined under Installation. The Home button's default setting returns the Robo Arm to an upright position .

---

**Freedrive** The on-screen **Freedrive** button allows the Robot Arm to be pulled into desired positions/poses.

---

**Align** The **Align** button allows the Z axis of the active TCP to align to a selected feature.

---

**Tool Position** The text boxes display the full coordinate values of the TCP relative to the selected feature. You can configure several named TCPs. You can also tap **Edit pose** to access the **Pose Editor** screen.

---

**Joint Position** The **Joint Position** field allows you to directly control individual joints. Each joint moves along a default joint limit range from  $-360^\circ$  to  $+360^\circ$ , defined by a horizontal bar. Once the limit is reached you cannot move a joint any further. You can configure joints with a position range different from the default, this new range is indicated with red zone inside the horizontal bar.

---

**Using Freedrive in the Move tab** The **Freedrive** button shall only be used in applications if allowed by the risk assessment.



#### WARNING

Failure to correctly configure the mounting setting can result in unwanted robot arm movement when you use the **Freedrive** button.

- Payload settings and robot mounting settings shall be set correctly before using Freedrive.
- All personnel shall remain outside the reach of the robot arm, when **Freedrive** is in use.



#### WARNING

Failure to correctly configure the installation settings, can increase the risk of the robot arm falling during **Freedrive**, due to payload errors.

- Verify the installation settings are correct (e.g. Robot mounting angle, payload mass and payload center of gravity offset) . Save and load the installation files along with the program.
- Save and load the installation files along with the program.

## 11.10. Pose Editor

### Description

Once you access the **Pose Editor** screen, you can precisely configure a target joint positions, or a target pose (position and orientation) for the TCP. Note: This screen is **offline** and does not control the Robot Arm directly.

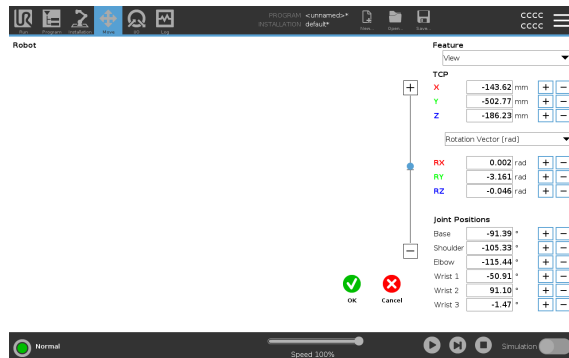

### Robot

The 3D image shows the current Robot Arm position. The **shadow** shows the Robot Arm target position controlled by the specified values on the screen. Press the magnifying glass icons to zoom in/out or drag a finger across it to change the view.

If the specified target position of the robot TCP is close to a safety or trigger plane, or the orientation of robot tool is near the tool orientation boundary limit, a 3D representation of the proximate boundary limit is shown. Safety planes are visualized in yellow and black with a small arrow representing the plane normal, which indicates the side of the plane on which the robot TCP is allowed to be positioned. Trigger planes are displayed in blue and green and a small arrow pointing to the side of the plane, where the **Normal** mode limits are active. The tool orientation boundary limit is visualized with a spherical cone together with a vector indicating the current orientation of the robot tool. The inside of the cone represents the allowed area for the tool orientation (vector). When the target robot TCP is no longer in proximity of the limit, the 3D representation disappears. If the target TCP is in violation or very close to violating a boundary limit, the visualization of the limit turns red.

- Feature and Tool Position** The active TCP and coordinate values of the selected feature are displayed. The **X, Y, Z** coordinates specify tool position. The **RX, RY, RZ** coordinates specify orientation. For further information about configuring several named TCPs. Use the drop down menu above the **RX, RY** and **RZ** boxes to choose the orientation representation type:
- **Rotation Vector [rad]** The orientation is given as a *rotation vector*. The length of the axis is the angle to be rotated in radians, and the vector itself gives the axis about which to rotate. This is the default setting.
  - **Rotation Vector [°]** The orientation is given as a *rotation vector*, where the length of the vector is the angle to be rotated in degrees.
  - **RPY [rad]** *Roll, pitch and yaw (RPY)* angles, where the angles are in radians. The RPY-rotation matrix (X, Y, Z" rotation) is given by:  

$$R_{rpy}(\gamma, \beta, \alpha) = RZ(\alpha) \cdot RY(\beta) \cdot RX(\gamma)$$
  - **RPY [°]** *Roll, pitch and yaw (RPY)* angles, where angles are in degrees.

You can tap the values to edit the coordinates. You can also tap the + or - buttons to the right of a box to add/subtract an amount to/from the current value. Or you can hold down a button to directly increase/decrease the value.

- Joint Positions** Individual joint positions are specified directly. Each joint position can have Joint Limit range from  $-360^\circ$  to  $+360^\circ$ . You can configure Joint Positions as follows:
- Tap the joint position to edit the values.
  - Tap the + or - buttons to the right of a box to add or subtract an amount to/from the current value.
  - Hold down a button to directly increase/decrease the value.

- OK Button** If you activate this screen from the **Move** screen, tap the **OK** button to return to the **Move** screen. The Robot Arm moves to the specified target. If the last specified value was a tool coordinate, the Robot Arm moves to the target position using movement type **MoveL**; or it uses movement type **MoveJ** if a joint position was specified last.

- Cancel Button** The **Cancel** button exits the screen discarding all changes.

# 12. Cybersecurity Threat Assessment

---

## Description

This section provides information to help you strengthen the robot against potential cybersecurity threats. It outlines requirements for addressing cybersecurity threats and provides security hardening guidelines.

---

## 12.1. General Cybersecurity

---

### Description

Connecting a Universal Robots robot to a network can introduce cybersecurity risks. These risks can be mitigated by using qualified personnel and implementing specific measures for protecting the robot's cybersecurity.

Implementing cybersecurity measures requires conducting a cybersecurity threat assessment.

The purpose is to:

- Identify threats
- Define trust zones and conduits
- Specify the requirements of each component in the application



#### WARNING

Failure to conduct a cybersecurity risk assessment can place the robot at risk.

- The integrator or competent, qualified personnel shall conduct a cybersecurity risk assessment.



#### NOTICE

Only competent, qualified personnel shall be responsible for determining the need for specific cybersecurity measures and for providing the required cybersecurity measures.

## 12.2. Cybersecurity Requirements

---

### Description

Configuring your network and securing your robot requires you to implement the threat measures for cybersecurity.

Follow all the requirements before you start configure your network, then verify the robot setup is secure.

---

**Cybersecurity**

- Operating personnel must have a thorough understanding of general cybersecurity principles and advanced technologies as used in the UR robot.
- Physical security measures must be implemented to allow only authorized personnel physical access to the robot.
- There must be adequate control of all access points. For example: locks on doors, badge systems, physical access control in general.

**WARNING**

Connecting the robot to a network that is not properly secured, can introduce security and safety risks.

- Only connect your robot to a trusted and properly secured network.

**Network configuration requirements**

- Only trusted devices are to be connected to the local network.
- There must be no inbound connections from adjacent networks to the robot.
- Outgoing connections from the robot are to be restricted to allow the smallest relevant set of specific ports, protocols and addresses.
- Only URCaps and magic scripts from trusted partners can be used, and only after verifying their authenticity and integrity

**Robot setup security requirements**

- Change the default password to a new, strong password.
- Disable the "Magic Files" when not actively used (PolyScope 5).
- Disable SSH access when not needed. Prefer key-based authentication over password-based authentication
- Set the robot firewall to the most restrictive usable settings and disable all unused interfaces and services, close ports and restrict IP addresses
-

## 12.3. Cybersecurity Hardening Guidelines

### Description

Although PolyScope includes many features for keeping the network connection secure, you can harden security by observing the following guidelines:

- Before connecting your robot to any network, always change the default password to a strong password.



#### NOTICE

You cannot retrieve or reset a forgotten or lost password.

- Store all passwords securely.

- Use the built-in settings to restrict the network access to the robot as much as possible.
- Some communication interfaces have no method of authenticating and encrypting communication. This is a security risk. Consider appropriate mitigating measures, based on your cybersecurity threat assessment.
- SSH tunneling (Local port forwarding) must be used to access robot interfaces from other devices if the connection crosses the trust zone boundary.
- Remove sensitive data from the robot before it is decommissioned. Pay particular attention to the URCaps and data in the program folder.
  - To ensure secure removal of highly sensitive data, securely wipe or destroy the SD card.

# 13. Communication Networks

---

**Fieldbus**

You can use the Fieldbus options to define and configure the family of industrial computer network protocols used for real-time distributed control accepted by PolyScope:

- MODBUS
  - Ethernet/IP
  - PROFINET
  - PROFIsafe
  - UR Connect
-

# 13.1. MODBUS

**Description** Here, the MODBUS client (master) signals can be set up. Connections to MODBUS servers (or slaves) on specified IP addresses can be created with input/output signals (registers or digital). Each signal has a unique name so it can be used in programs.



**Refresh** Push this button to refresh all MODBUS connections. Refreshing disconnects all modbus units, and connects them back again. All statistics are cleared.

**Add unit** Push this button to add a new MODBUS unit.

**Delete unit** Push this button to delete the MODBUS unit and all signals on that unit.

**Set unit IP** Here the IP address of the MODBUS unit is shown. Press the button to change it.

**Sequential mode** *Available only when Show Advanced Options selected.* Selecting this checkbox forces the modbus client to wait for a response before sending the next request. This mode is required by some fieldbus units. Turning this option on may help when there are multiple signals, and increasing request frequency results in signal disconnects. The actual signal frequency may be lower than requested when multiple signals are defined in sequential mode. Actual signal frequency can be observed in signal statistics. The signal indicator turns yellow if the actual signal frequency is less than half of the value selected from the **Frequency** drop-down list.

**Add signal** Push this button to add a signal to the corresponding MODBUS unit.

**Delete signal** Push this button to delete a MODBUS signal from the corresponding MODBUS unit.

**Set signal type** Use this drop down menu to choose the signal type.  
Available types are:

<i>Digital input</i>	A digital input (coil) is a one-bit quantity which is read from the MODBUS unit on the coil specified in the address field of the signal. Function code 0x02 (Read Discrete Inputs) is used.
<i>Digital output</i>	A digital output (coil) is a one-bit quantity which can be set to either high or low. Before the value of this output has been set by the user, the value is read from the remote MODBUS unit. This means that function code 0x01 (Read Coils) is used. When the output has been set by a robot program or by pressing the <b>set signal value</b> button, the function code 0x05 (Write Single Coil) is used onwards.
<i>Register input</i>	A register input is a 16-bit quantity read from the address specified in the address field. The function code 0x04 (Read Input Registers) is used.
<i>Register output</i>	A register output is a 16-bit quantity which can be set by the user. Before the value of the register has been set, the value of it is read from the remote MODBUS unit. This means that function code 0x03 (Read Holding Registers) is used. When the output has been set by a robot program or by specifying a signal value in the <b>set signal value</b> field, function code 0x06 (Write Single Register) is used to set the value on the remote MODBUS unit.

---

**Set signal address** This field shows the address on the remote MODBUS server. Use the on-screen keypad to choose a different address. Valid addresses depends on the manufacturer and configuration of the remote MODBUS unit.

---

**Set signal name** Using the on-screen keyboard, the user can give the signal a name. This name is used when the signal is used in programs.

---

**Signal value** Here, the current value of the signal is shown. For register signals, the value is expressed as an unsigned integer. For output signals, the desired signal value can be set using the button. Again, for a register output, the value to write to the unit must be supplied as an unsigned integer.

---

**Signal  
connectivity  
status**

This icon shows whether the signal can be properly read/written (green), or if the unit responds unexpected or is not reachable (gray). If a MODBUS exception response is received, the response code is displayed. The MODBUS-TCP Exception responses are:

<i>E1</i>	ILLEGAL FUNCTION (0x01) The function code received in the query is not an allowable action for the server (or slave).
<i>E2</i>	ILLEGAL DATA ADDRESS (0x02) The function code received in the query is not an allowable action for the server (or slave), check that the entered signal address corresponds to the setup of the remote MODBUS server.
<i>E3</i>	ILLEGAL DATA VALUE (0x03) A value contained in the query data field is not an allowable value for server (or slave), check that the entered signal value is valid for the specified address on the remote MODBUS server.
<i>E4</i>	SLAVE DEVICE FAILURE (0x04) An unrecoverable error occurred while the server (or slave) was attempting to perform the requested action.
<i>E5</i>	ACKNOWLEDGE (0x05) Specialized use in conjunction with programming commands sent to the remote MODBUS unit.
<i>E6</i>	SLAVE DEVICE BUSY (0x06) Specialized use in conjunction with programming commands sent to the remote MODBUS unit, the slave (server) is not able to respond now.

**Show  
Advanced  
Options**

This check box shows/hides the advanced options for each signal.

### Advanced Options

<i>Update Frequency</i>	This menu can be used to change the update frequency of the signal. This means the frequency with which requests are sent to the remote MODBUS unit for either reading or writing the signal value. When the frequency is set to 0, then modbus requests are initiated on demand using a <i>modbus_get_signal_status</i> , <i>modbus_set_output_register</i> , and <i>modbus_set_output_signal</i> script functions.
<i>Slave Address</i>	This text field can be used to set a specific slave address for the requests corresponding to a specific signal. The value must be in the range 0-255 both included, and the default is 255. If you change this value, it is recommended to consult the manual of the remote MODBUS device to verify its functionality when changing slave address.
<i>Reconnect count</i>	Number of times TCP connection was closed, and connected again.
<i>Connection status</i>	TCP connection status.
<i>Response time [ms]</i>	Time between modbus request sent, and response received - this is updated only when communication is active.
<i>Modbus packet errors</i>	Number of received packets that contained errors (i.e. invalid length, missing data, TCP socket error).
<i>Timeouts</i>	Number of modbus requests that didn't get response.
<i>Requests failed</i>	Number of packets that could not be sent due to invalid socket status.
<i>Actual freq.</i>	The average frequency of client (master) signal status updates. This value is recalculated each time the signal receives a response from the server (or slave).

All counters count up to 65535, and then wrap back to 0.

## 13.2. EtherNet/IP

---

### Description

EtherNet/IP is a network protocol that enables the connection of the robot to an industrial EtherNet/IP Scanner Device.

If the connection is enabled, you can select the action that occurs when a program loses EtherNet/IP Scanner Device connection.

Those actions are:

<i>None</i>	PolyScope ignores the loss of EtherNet/IP connection and the program continues to run.
<i>Pause</i>	PolyScope pauses the current program. The program resumes from where it stopped.
<i>Stop</i>	PolyScope stops the current program.

---

## 13.3. PROFINET

---

### Description

The PROFINET network protocol enables or disables the connection of the robot to an industrial PROFINET IO-Controller.

If the connection is enabled, you can select the action that occurs when a program loses PROFINET IO-Controller connection.

Those actions are:

<i>None</i>	PolyScope ignores the loss of PROFINET connection and the program continues to run.
<i>Pause</i>	PolyScope pauses the current program. The program resumes from where it stopped.
<i>Stop</i>	PolyScope stops the current program.

If the PROFINET engineering tool (e.g. TIA portal) emits a DCP Flash signal to the robot's PROFINET or PROFIsafe device, a popup in PolyScope is displayed.

---

## 13.4. PROFIsafe

### Description



#### NOTICE

SW 5.25 provided a significant software update to PROFIsafe. Please see the safety notice online: <https://www.universal-robots.com/articles/ur/safety/safety-notice-profisafe-2/>

The PROFIsafe network protocol (implemented as version 2.6.1) allows the robot to communicate with a safety PLC according to ISO 13849, Cat 3 PLd requirements. The robot transmits safety state information to a safety PLC, then receives information to be reduced or to trigger a safety related function like an emergency stop.

The PROFIsafe interface provides a safe, network-based alternative to connecting wires to the safety IO pins of the robot control box.

PROFIsafe is only available on robots that have an enabling license, which you can obtain by contacting your local sales representative, once obtained, the license can be downloaded on [myUR](#).

Please refer to [Robot Registration and URcap License files](#) for information regarding robot registration and license activation.

**Safety  
PLC Out**

A control message that the safety PLC sends to the robot contains the information shown in the following table.

Signal	Description
E-Stop by system	<ul style="list-style-type: none"> <li>• 0: Asserts the system e-stop.</li> <li>• 1: Clear system e-stop.</li> </ul>
Safeguard stop	<ul style="list-style-type: none"> <li>• 0: Asserts the safeguard stop.</li> <li>• 1: Normal operation state.</li> </ul> <p><b>Note:</b> Also refer to the "Reset safeguard stop" signal description.</p>
Reset safeguard stop	Resets the safeguard stop state on a 0-to-1 transition when the "safeguard stop" signal is already set to 1.
Safeguard stop auto	<ul style="list-style-type: none"> <li>• 0: Asserts safeguard stop if the robot is operating in Automatic mode.</li> <li>• 1: Normal operation state.</li> </ul> <p>Safeguard stop auto shall only be used when a 3-Position Enabling (3PE) Device is configured. If no 3PE Device is configured, the safeguard stop auto acts as a normal safeguard stop input.</p> <p><b>Note:</b> Also refer to the "Reset safeguard stop auto" signal description.</p>
Reset safeguard stop auto	Resets the safeguard stop auto state on a 0-to-1 transition when the "safeguard stop auto" signal is already set to 1.
Reduced	<ul style="list-style-type: none"> <li>• 0: Activates the Reduced safety limits.</li> <li>• 1: Activates the "Normal mode" safety limits.</li> </ul> <p>The safety system guarantees the robot is within reduced limits less than 0.5s after the input is activated. If the robot arm continues to violate any of the reduced limits, a Stop Category 0 is triggered.</p>
Operational mode	<ul style="list-style-type: none"> <li>• 0: Activates the manual operational mode.</li> <li>• 1: Activates the automatic operational mode.</li> </ul> <p>If the safety configuration "Operational mode selection via PROFIsafe" is disabled, this field shall be omitted from the PROFIsafe control message.</p>

**Safety PLC In** A status message that the robot sends to the safety PLC contains the information shown in the following table.

Signal	Description
Stop, cat. 0	<ul style="list-style-type: none"> <li>0: Robot is performing, or has completed, a safety stop of category 0; a hard stop by immediate removal of power to the arm and the motors.</li> <li>1: Normal operation state.</li> </ul>
Stop, cat. 1	<ul style="list-style-type: none"> <li>0: Robot is performing, or has completed, a safety stop of category 1; a controlled stop after which the motors are left in a power-off state with brakes engaged.</li> <li>1: Normal operation state.</li> </ul>
Stop, cat. 2	<ul style="list-style-type: none"> <li>0: Robot is performing, or has completed, a safety stop of category 2; a controlled stop after which the motors are left in a power-on state.</li> <li>1: Normal operation state.</li> </ul>
Violation	<ul style="list-style-type: none"> <li>0: Robot is stopped because the safety system has failed to comply with the active safety limits defined.</li> <li>1: Normal operation state.</li> </ul>
Fault	<ul style="list-style-type: none"> <li>0: Robot is stopped because of an unexpected exceptional error in the safety system.</li> <li>1: Robot is not experiencing an unexpected exceptional error in the safety system.</li> </ul>
E-stop by system	<ul style="list-style-type: none"> <li>0: Robot is stopped because of one of the following conditions: <ul style="list-style-type: none"> <li>A safety PLC connected via PROFIsafe has asserted a system level e-stop.</li> <li>An IMMI module connected to the control box has asserted a system level e-stop.</li> <li>A unit connected to the system e-stop configurable safety input of the control box has asserted a system level e-stop.</li> </ul> </li> <li>1: Robot is not in system e-stop.</li> </ul>
E-stop by robot	<ul style="list-style-type: none"> <li>0: The robot is stopped because of one of the following conditions: <ul style="list-style-type: none"> <li>The e-stop button of the teach pendant is pressed.</li> <li>An e-stop button connected to the robot e-stop non-configurable safety input of the control box is pressed.</li> </ul> </li> <li>1: Robot is not in e-stop by robot.</li> </ul>

Signal	Description
Safeguard stop	<ul style="list-style-type: none"> <li>• 0: The robot is stopped due to one of the following conditions:                             <ul style="list-style-type: none"> <li>• A safety PLC connected via PROFIsafe has asserted the safeguard stop.</li> <li>• A unit connected to the safeguard stop nonconfigurable input of the control box has asserted the safeguard stop.</li> <li>• A unit connected to the safeguard stop configurable safety input of the control box has asserted the safeguard stop.</li> </ul> </li> <li>• 1: The robot is not stopped due to a safeguard stop.</li> </ul> <p><b>Note:</b> Also refer to the “Reset safeguard stop” signal description. PROFIsafe enforces the use of the safeguard reset functionality.</p>
Safeguard stop auto	<p>0: The robot is stopped because it is operating in Automatic mode and one of the following conditions applies:</p> <ul style="list-style-type: none"> <li>• A safety PLC connected via PROFIsafe has asserted safeguard stop auto.</li> <li>• A unit connected to a safeguard stop auto configurable safety input of the control box has asserted safeguard stop auto.</li> </ul> <p>1: The robot is not stopped due to safeguard stop auto.</p> <p><b>Note:</b> Also refer to the “Reset safeguard stop auto” signal description. PROFIsafe enforces the use of the safeguard reset functionality.</p>
3PE stop	<ul style="list-style-type: none"> <li>• 0: The robot is stopped because it is operating in Manual mode and one of the following conditions applies:                             <ul style="list-style-type: none"> <li>• Any 3PE is pressed to the middle position, and Freedrive input is active.</li> <li>• Not all 3PE devices are pressed to the middle position.</li> </ul> </li> <li>• 1: Robot is not stopped because of a 3-position enabling device.</li> </ul>
Operational mode	<p>Indication of the active operational mode of the robot.</p> <ul style="list-style-type: none"> <li>• 0: Disabled</li> <li>• 1: Automatic</li> <li>• 2: Manual</li> </ul>
Reduced	<ul style="list-style-type: none"> <li>• 0: Reduced safety limits are active.</li> <li>• 1: Normal safety limits are active.</li> </ul>

Copyright © 2009-2025 by Universal Robots A/S. All rights reserved.

Signal	Description
Active limit set	<p>The active set of safety limits.</p> <ul style="list-style-type: none"> <li>• 0: Normal</li> <li>• 1: Reduced</li> <li>• 2: Recovery</li> </ul>
Robot moving	<ul style="list-style-type: none"> <li>• 0: Robot is moving. If any joint moves at a velocity of 0.02 rad/s or higher, the robot is considered in motion.</li> <li>• 1: Robot is at standstill.</li> </ul>
Safe home position	<ul style="list-style-type: none"> <li>• 0: Robot is at rest (robot not moving), and in the position defined as the Safe Home Position.</li> <li>• 1: Robot is not at rest, or not in the position defined as the Safe Home Position.</li> </ul>

### Configuring PROFIsafe

Configuring PROFIsafe relates to programming the safety PLC, but requires minimal robot setup.

1. Connect the robot to a trusted network that accesses a safety compliant PLC.
2. On PolyScope, in the Header, tap **Installation**.
3. Tap Safety, select **PROFIsafe** and configure as needed.

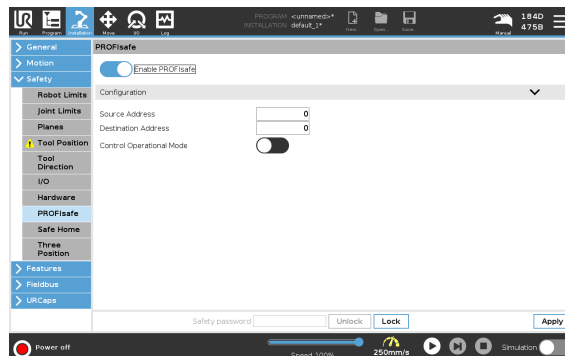

### Enabling PROFIsafe

1. Enter the robot safety password and tap **Unlock**.
2. Use the switch button to enable PROFIsafe.
3. Enter a source address and destination address into the corresponding boxes.
 

These addresses are arbitrary numbers used by the robot and the safety PLC to identify each other.
4. You can switch the Control Operational Mode to the ON position if you want PROFIsafe to control the robot operational mode.
 

Only one source can control the operational mode of the robot. Therefore other sources of mode selection are disabled when operational mode selection via PROFIsafe is enabled.

The robot is now setup to communicate with a safety PLC. You cannot release the robot's brakes if the PLC is not responding or if it is misconfigured.

## 13.5. UR Connect

---

**Description** The URCap UR Connect comes pre-installed with 5.19 PolyScope 5 software. To ensure correct operation, there are some additional prerequisites that must be installed. Please refer to the URCap documentation for additional information. [UR Connect Installation and User Guide](#)  
Go here for more information about the product: <https://www.universal-robots.com/optimization-services/ur-connect/>

---

**Install UR Connect** To install the UR Connect, please follow the steps below:

1. Go to the Installation tab.
2. Hit the tab URCaps in the left side of the screen.
3. Hit Install to start installation the prerequisites.
4. Follow the steps on the screen.

---

**Activate UR Connect** The UR Connect URCap needs to be paired with myUR to send data to MyUR. Please refer to the MyUR documentation on the UR Connect for further information.

---

**UR Connect URCap Update** You can find the URCaps on the Installation Tab.

1. Go to the Installation tab.
2. Hit the tab URCaps in the left side of the screen.
3. Hit the button Check for Updates in the bottom right corner.
4. You can now download, dismiss or delay the update.
  - a. If you delay or dismiss, the update will only refresh when there is a new version.
5. Follow the update steps.
6. Restart PolyScope when the update is complete.



### NOTICE

You can still update UR Connect even if it is NOT installed.

---

# 14. Risk Assessment

---

## Description

The risk assessment is a requirement that shall be performed for the application. The application risk assessment is the responsibility of the integrator. The user can also be the integrator.

The robot is partly completed machinery, as such the safety of the robot application depends on the tool/end effector, obstacles and other machines. The party performing the integration must use ISO 12100 and ISO 10218-2 to conduct the risk assessment. Technical Specification ISO/TS 15066 can provide additional guidance for collaborative applications. The risk assessment shall consider all tasks throughout the lifetime of the robot application, including but not limited to:

- Teaching the robot during set-up and development of the robot application
- Troubleshooting and maintenance
- Normal operation of the robot application

A risk assessment must be conducted **before** the robot application is powered on for the first time. The risk assessment is an iterative process. After physically installing the robot, verify the connections, then complete the integration. A part of the risk assessment is to determine the safety configuration settings, as well as the need for additional emergency stops and/or other protective measures required for the specific robot application.

---

### Safety configuration settings

Identifying the correct safety configuration settings is a particularly important part of developing robot applications. Unauthorized access to the safety configuration must be prevented by enabling and setting password protection.



#### WARNING

Failure to set password protection can result in injury or death due to purposeful or inadvertent changes to configuration settings.

- Always set password protection.
- Set up a program for managing passwords, so that access is only by persons who understand the effect of changes.

Some safety functions are purposely designed for collaborative robot applications. These are configurable through the safety configuration settings. They are used to address risks identified in the application risk assessment.

The following limit the robot and as such can affect the energy transfer to a person by the robot arm, end effector and workpiece.

- **Force and power limiting:** Used to reduce clamping forces and pressures exerted by the robot in the direction of movement in case of collisions between the robot and the operator.
- **Momentum limiting:** Used to reduce high transient energy and impact forces in case of collisions between robot and operator by reducing the speed of the robot.
- **Speed limitation:** Used to ensure the speed is less than the configured limit.

The following orientation settings are used to avoid movements and reduce exposure of sharp edges and protrusions to a person.

- **Joint, elbow and tool/end effector position limiting:** Used to reduce risks associated with certain body parts: Avoid movement towards head and neck.
- **Tool/end effector orientation limiting:** Used to reduce risks associated with certain areas and features of the tool/end effector and work-piece: Avoid sharp edges being pointed towards the operator, by turning the sharp edges inward towards the robot.

### Stopping performance risks

Some safety functions are purposely designed for any robot application. These features are configurable through the safety configuration settings. They are used to address risks associated with the stopping performance of the robot application.

The following limit the robot stopping time and stopping distance to ensure stopping will occur before reaching the configured limits. Both settings automatically affect the speed of the robot to ensure the limit is not exceeded.

- **Stopping Time Limit:** Used to limit the stopping time of the robot.
- **Stopping Distance Limit:** Used to limit the stopping distance of the robot.

If either of the above is used, there is no need for manually performed periodic stopping performance testing. The robot safety control does continuous monitoring.

If the robot is installed in a robot application where hazards cannot be reasonably eliminated or risks cannot be sufficiently reduced by use of the built-in safety-related functions (e.g. when using a hazardous tool/end effector, or hazardous process), then safeguarding is required.

**WARNING**

Failure to conduct a application risk assessment can increase risks.

- Always conduct an application risk assessment for foreseeable risks and reasonably foreseeable misuse.

For collaborative applications, the risk assessment includes the foreseeable risks due to collisions and to reasonably foreseeable misuse.

The risk assessment shall address:

- Severity of harm
- Likelihood of occurrence
- Possibility to avoid the hazardous situation

**Potential hazards**

Universal Robots identifies the potential significant hazards listed below for consideration by the integrator. Other significant hazards can be associated with a specific robot application.

- Penetration of skin by sharp edges and sharp points on tool/end effector or tool/end effector connector.
- Penetration of skin by sharp edges and sharp points on nearby obstacles.
- Bruising due to contact.
- Sprain or bone fracture due to impact.
- Consequences due to loose bolts that hold the robot arm or tool/end effector.
- Items falling out of, or flying from the tool/end effector, e.g. due to a poor grip or power interruption.
- Mistaken understanding of what is controlled by multiple emergency stop buttons.
- Incorrect setting of the safety configuration parameters.
- Incorrect settings due to unauthorized changes to the safety configuration parameters.

# 14.1. Pinch Hazard

**Description** You can avoid pinching hazards by removing obstacles in these areas, by placing the robot differently, or by using a combination of safety planes and joint limits to eliminate the hazards by preventing the robot moving into this area of its workspace.

 **CAUTION**  
Placing the robot in certain areas can create pinching hazards that can lead to injury.

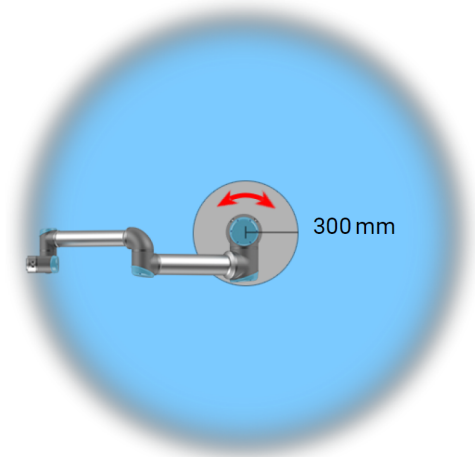
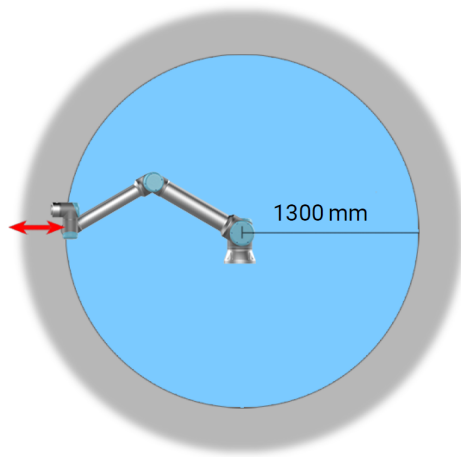

*Due to the physical properties of the robot arm, certain workspace areas require attention regarding pinching hazards. One area (left) is defined for radial motions when the wrist 1 joint is at least 1300 mm from the base of the robot. The other area (right) is within 300 mm of the base of the robot, when moving tangentially.*

Copyright © 2009-2025 by Universal Robots A/S. All rights reserved.

## 14.2. Stopping Time and Stopping Distance

### Description



#### NOTICE

You can set user-defined safety rated maximum stopping time and distance.  
If user-defined settings are used, the program speed is dynamically adjusted to always comply with the selected limits.

The graphical data provided for **Joint 0 (base)**, **Joint 1 (shoulder)** and **Joint 2 (elbow)** is valid for stopping distance and stopping time:

- Category 0
- Category 1
- Category 2

The **Joint 0** test was carried out using a horizontal movement, where the rotational axis was perpendicular to the ground. For the **Joint 1** and **Joint 2** tests, the robot followed a vertical trajectory, where the rotational axes were parallel to the ground, and the stop was done while the robot was moving downward.

The Y-axis is the distance from where the stop is initiated to the final position. The payload CoG is at the tool flange.

**Joint 0 (BASE)**  
Stopping distance in meters for 33% of 12.5kg

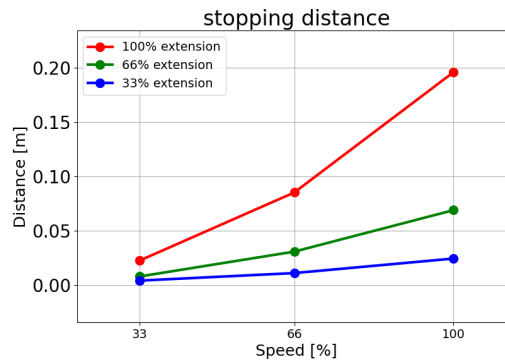

Stopping distance in meters for 66% of 12.5kg

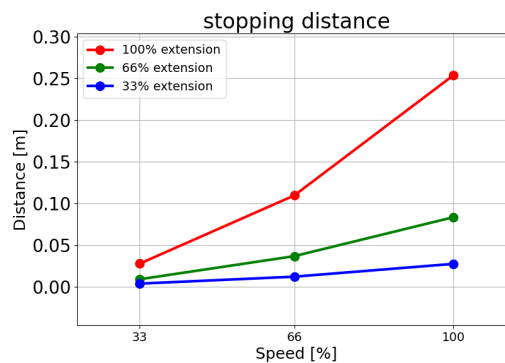

Stopping distance in meters for maximum payload of 12.5kg

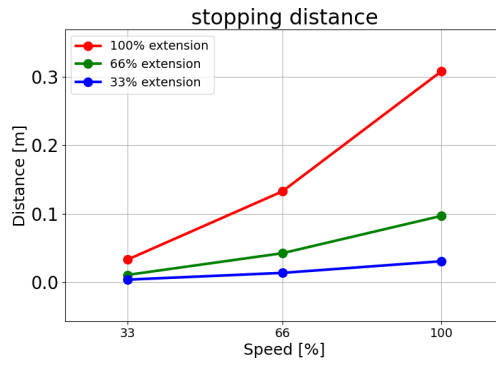

**Joint 0 (BASE)**

Stopping time in seconds for 33% of 12.5kg

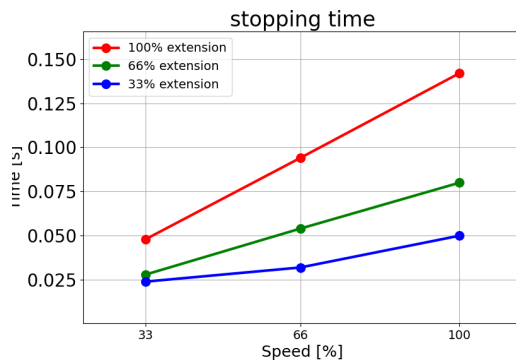

Stopping time in seconds for 66% of 12.5kg

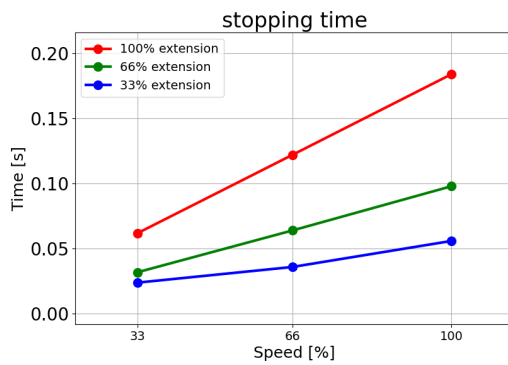

Stopping time in seconds for maximum payload of 12.5kg

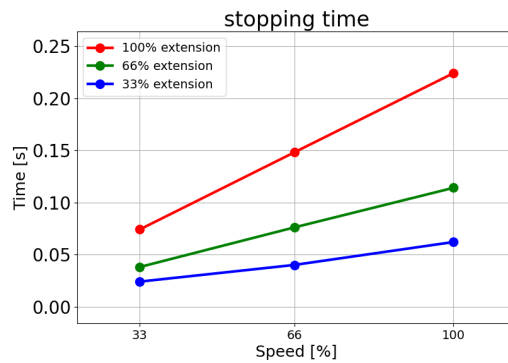

Copyright © 2009-2025 by Universal Robots A/S. All rights reserved.

**Joint 1 (SHOULDER)**

Stopping distance in meters for 33% of 12.5kg

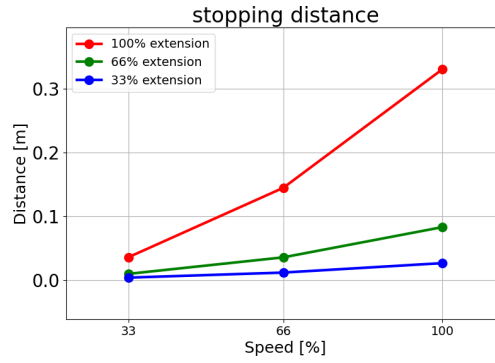

Stopping distance in meters for 66% of 12.5kg

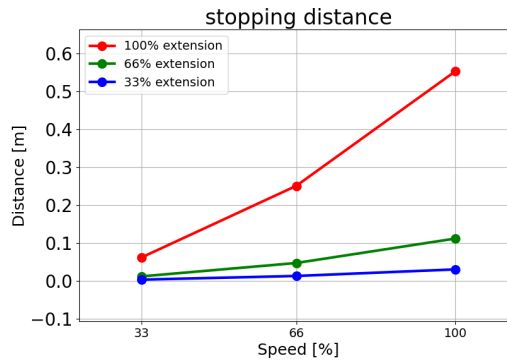

Stopping distance in meters for maximum payload of 12.5kg

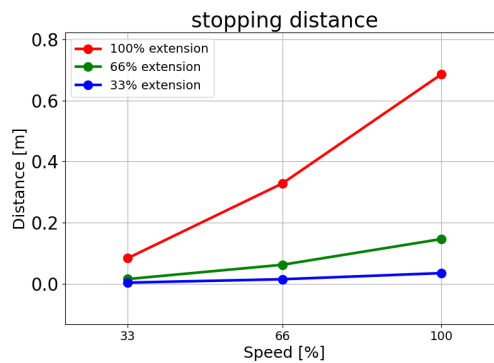

Copyright © 2009-2025 by Universal Robots A/S. All rights reserved.

**Joint 1 (SHOULDER)**

Stopping time in seconds for 33% of 12.5kg

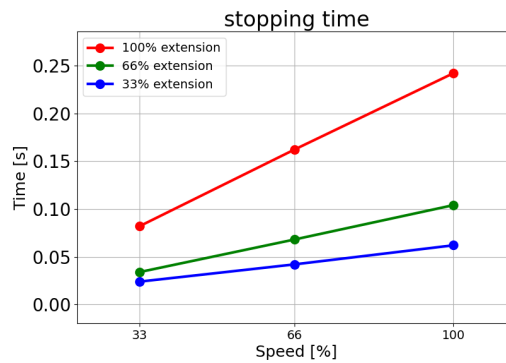

Stopping time  
in seconds for  
66% of  
12.5kg

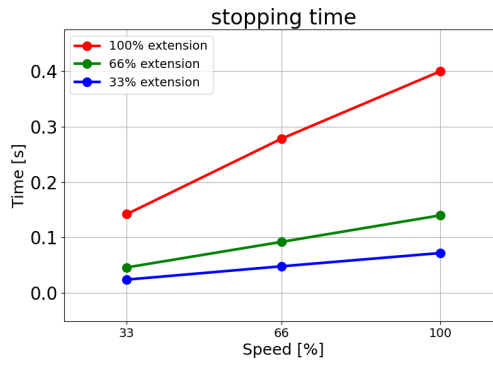

Stopping time  
in seconds for  
maximum  
payload of  
12.5kg

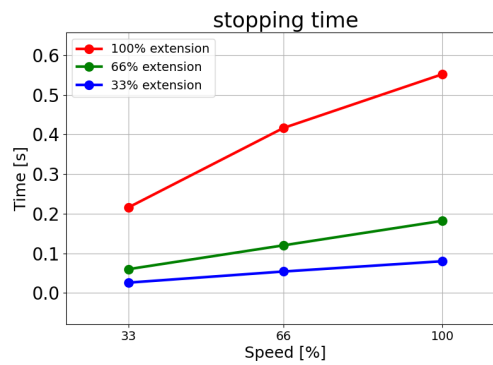

**Joint 2  
(ELBOW)**

Stopping  
distance in  
meters for  
33% of 12.5kg

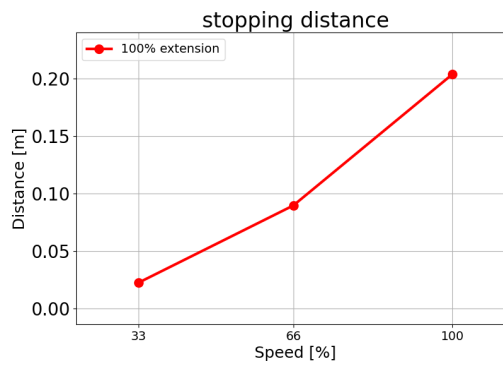

Stopping  
distance in  
meters for  
66% of  
12.5kg

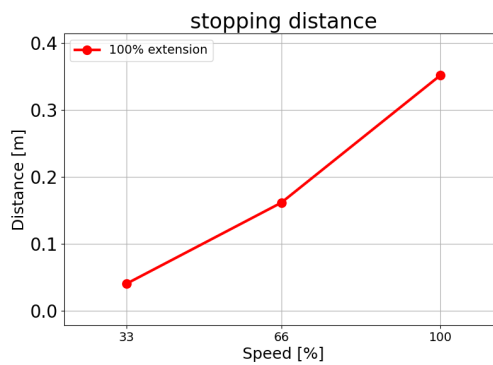

Stopping distance in meters for the maximum payload of 12.5kg

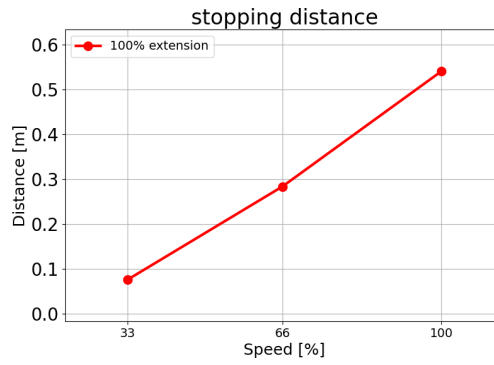

**Joint 2 (ELBOW)**

Stopping time in seconds for 33% of 12.5kg

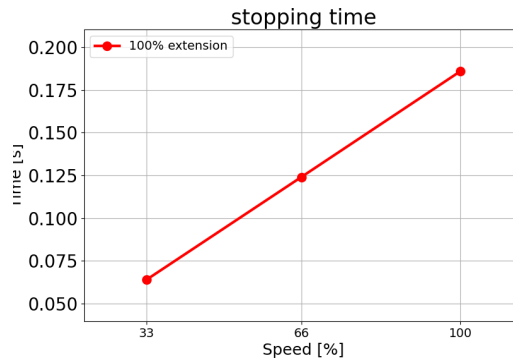

Stopping time in seconds for 66% of 12.5kg

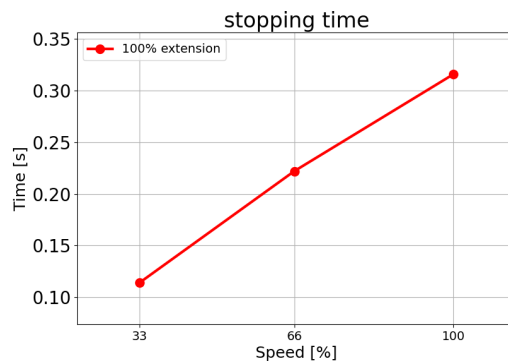

Stopping time in seconds for the maximum payload of 12.5kg

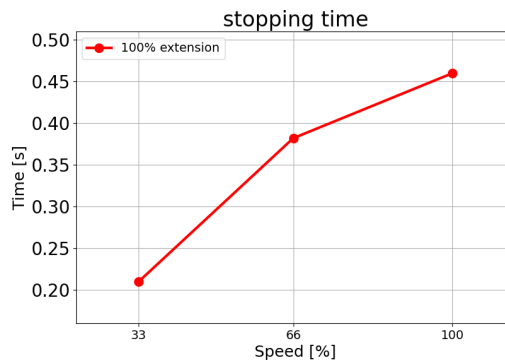

# 15. Emergency Events

---

**Description** Follow the instructions here to handle emergency situations, such as activating the emergency stop using the red push-button. This section also describes how to manually move the system without power.

---

## 15.1. Emergency Stop

---

**Description** The Emergency Stop or E-stop is the red push-button located on the Teach Pendant. Press the emergency stop push-button to stop all robot motion. Activating the emergency stop push-button causes a stop category one (IEC 60204-1). Emergency stops are not safeguards (ISO 12100).

Emergency stops are complementary protective measures that do not prevent injury. The risk assessment of the robot application determines if additional emergency stop push-buttons are required. The emergency stop function and the actuating device must comply with ISO 13850.

After an emergency stop is actuated, the push-button latches in that setting. As such, each time an emergency stop is activated, it must be manually reset at the push-button that initiated the stop.

Before resetting the emergency stop push-button, you must visually identify and assess the reason the E-stop was first activated. Visual assessment of all the equipment in the application is required. Once the problem is solved, reset the emergency stop push-button.

### To reset the emergency stop push-button

1. Hold the push-button and twist clockwise until the latching disengages.  
You should feel when the latching is disengaged, indicating the push-button is reset.
  2. Verify the situation and whether to reset the emergency stop.
  3. After resetting the emergency stop, restore power to the robot and resume operation.
-

## 15.2. Movement Without Drive Power

### Description

In the event of an emergency, when powering the robot is either impossible or unwanted, you can use forced back-driving to move the robot arm.

Forced back-driving requires you to push, or pull, the robot arm hard to move the joint. Bigger robot arms can involve more than one person to move the joint.

Each joint brake has a friction clutch that enables movement during high forced torque. Forced back-driving requires high force and one or more people may be required to move the robot.

In clamping situations, two or more people are required to do the forced back-driving. In some situations, two or more people are required to disassemble the robot arm.

Personnel using the UR robot are to be trained to respond to emergency events. Supplemental information shall be provided, on integration.



#### WARNING

Risks due to an unsupported robot arm breaking or falling can cause injury or death.

- Do not disassemble the robot during an emergency event.
- Support the robot arm before removing power.



#### NOTICE

Moving the robot arm manually is intended for emergency and service purposes only. Unnecessary moving of the robot arm can lead to property damage.

- Do not move the joint more than 160 degrees, to ensure the robot can find its original physical position.
- Do not move any joint more than necessary.

## 15.3. Modes

**Description** You access and activate different modes using Teach Pendant or the Dashboard Server. If an external mode selector is integrated, it control the modes - not PolyScope or the Dashboard Server.

**Automatic Mode** Once activated, the robot can only execute a program of pre-defined tasks. You cannot modify or save programs and installations.

**Manual Mode** Once activated, you can program the robot. You can modify and save programs and installations.

The speeds used in Manual Mode must be limited to prevent injury. When the robot is operating in Manual Mode, a person could be positioned within reach of the robot. The speed must be limited to the value that is appropriate for the application risk assessment.



**WARNING**

Injury can occur if the speed used, while the robot is operating in Manual Mode, is too high.

High Speed Manual Mode can be used. It allows both tool speed and elbow speed to temporarily exceed 250 mm/s, while a hold-to-run is used. Hold-to-run is performed by continuous contact with the Speed Slider.

The robot performs a Safeguard Stop in Manual mode, if a Three-Position Enabling Device is configured, and either released (not pressed) or it is fully compressed.

Switching between Automatic mode to Manual mode requires the Three-Position Enabling Device to be fully released and pressed again to allow the robot to move. When using High Speed Manual Mode, use safety joint limits or safety planes to restrict the robot's moving space.

**Mode switching**

Operational mode	Manual	Automatic
Freedrive	x	*
Move robot with arrows on Move Tab	x	*
Edit & save program & installation	x	
Execute Programs	Reduced speed**	*
Start program from selected node	x	
*Only when no Three-Position Enabling Device is configured. ** If a Three-Position Enabling Device is configured, the robot operates at Manual Reduced Speed unless High Speed Manual Mode is activated.		



#### WARNING

- Any suspended safeguards must be returned to full functionality before selecting Automatic Mode.
- Wherever possible, Manual Mode shall only be used with all persons located outside the safeguarded space.
- If an external mode selector is used, it must be placed outside the safeguarded space.
- No-one is to enter, or be within, the safeguarded space in Automatic Mode, unless safeguarding is used or the collaborative application is validated for power and force limiting (PFL).

### Three-Position Enabling Device

When a Three-Position Enabling Device is used and the robot is in Manual Mode, movement requires pressing the Three-Position Enabling Device to the center-on position. The Three-Position Enabling Device has no effect in Automatic Mode.



#### NOTICE

- Some UR robot sizes might not be equipped with a Three-Position Enabling Device. If the risk assessment requires the enabling device, a 3PE Teach Pendant must be used.

A 3PE Teach Pendant (3PE TP) is recommended for programming. If another person can be within the safeguarded space when in Manual Mode, an additional device can be integrated and configured for the additional person's use.

---

## 15.3.1. Recovery Mode

**Description** When a safety limit is exceeded, Recovery Mode is automatically activated, allowing the robot arm to be moved. Recovery Mode is a type of Manual Mode . You cannot run robot programs when Recovery Mode is active.

During Recovery Mode, the robot arm is moved to be within joint limits, using either Freedrive or the Move tab in PolyScope.

### Safety limits of Recovery Mode

Safety Function	Limit
Joint Speed Limit	30 °/s
Speed Limit	250 mm/s
Force Limit	100 N
Momentum Limit	10 kg m/s
Power Limit	80 W

The safety system issues a Stop Category 0 if a violation of these limits appears.



#### WARNING

Failure to use caution when moving the robot arm in recovery mode can lead to hazardous situations.

- Use caution when moving the robot arm back within the limits, as limits for the joint positions, the safety planes, and the tool/end effector orientation are all disabled in recovery.

## 15.3.2. Backdrive

**Description** Backdrive is a Manual Mode used to force specific joints to a desired position without releasing all brakes in the robot arm. This is sometimes necessary if the robot arm is close to collision and the vibrations that accompany a full restart are not desired. The robot joints feel heavy to move, while Backdrive is in use.

You can use any of the following sequences to enable Backdrive:

- 3PE Teach Pendant
- 3PE device/switch
- Freedrive on robot

**3PE Teach  
Pendant**

To use the 3PE TP button to backdrive the robot arm.

1. On the Initialize screen, tap **ON** to start the power up sequence.
2. When the robot state is **Teach Pendant 3PE Stop**, light-press, then light-press-and-hold, the 3PE TP button.  
The robot state changes to **Backdrive**.
3. Now you can apply significant pressure to release the brake in a desired joint to move the robot arm.  
As long as light-press is maintained on the 3PE button, Backdrive is enabled, allowing the arm to move.

**3PE  
device/switch**

To use a 3PE device/switch to backdrive the robot arm.

1. On the Initialize screen, tap **ON** to start the power up sequence.
2. When the robot state is **Teach Pendant 3PE Stop**, light-press, then light-press-and-hold, the 3PE TP button.  
The robot state changes to **System 3PE Stop**.
3. Press and hold the 3PE device/switch.  
The robot state changes to **Backdrive**.
4. Now you can apply significant pressure to release the brake in a desired joint to move the robot arm.  
As long as the hold is maintained on both the 3PE device/switch and the 3PE TP button, Backdrive is enabled, allowing the arm to move.

**Freedrive on  
robot**

To use Freedrive on robot to backdrive the robot arm.

1. On the Initialize screen, tap **ON** to start the power up sequence.
  2. When the robot state is **Teach Pendant 3PE Stop**, press and hold the **Freedrive on robot**.  
The robot state changes to **Backdrive**.
  3. Now you can apply significant pressure to release the brake in a desired joint to move the robot arm.  
As long as the hold is maintained on the Freedrive on robot, Backdrive is enabled, allowing the arm to move.
-

## Backdrive Inspection

---

**Description** If the robot is close to colliding with something, you can use Backdrive to move the robot arm to a safe position before initializing.

**3PE Teach Pendant**

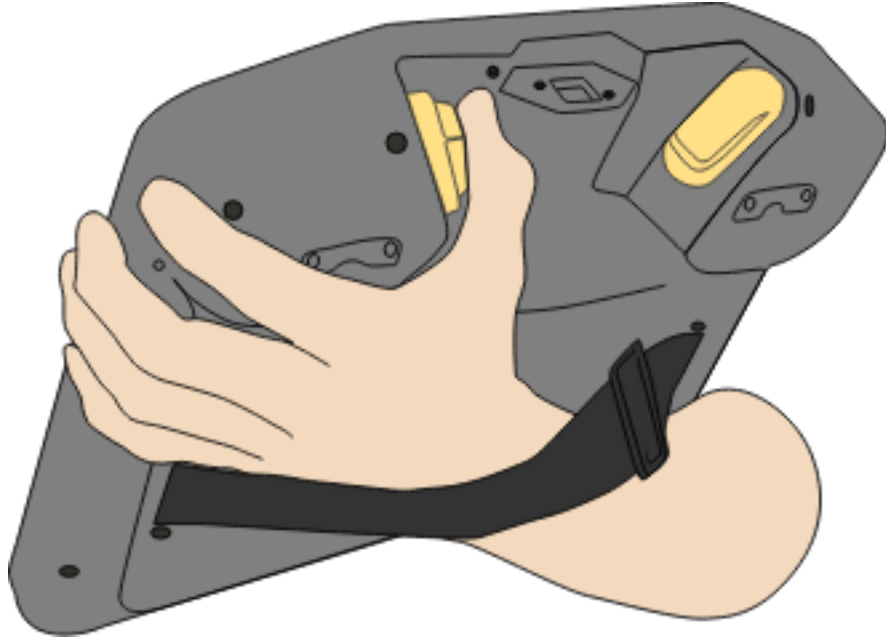

Copyright © 2009-2025 by Universal Robots A/S. All rights reserved.

**Enable Backdrive**

1. Press ON to enable power. Status changes to *Robot Active*

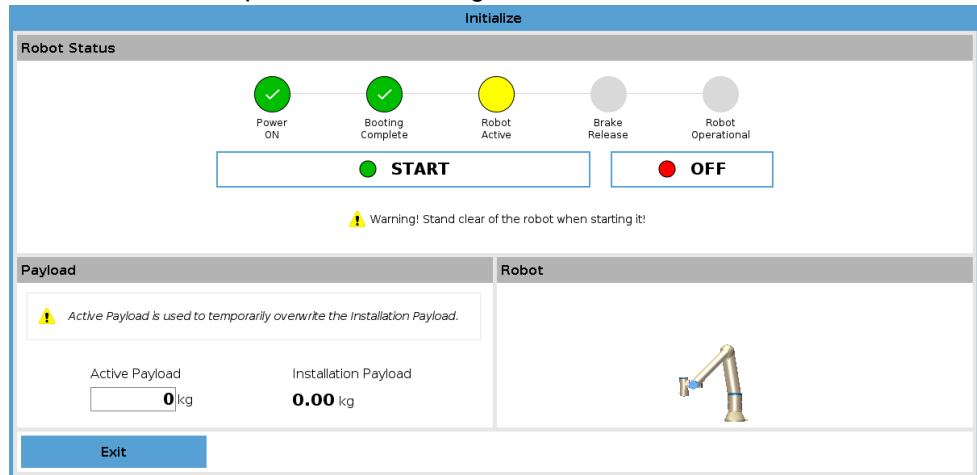

2. Press and hold Freedrive. Status changes to *Backdrive*

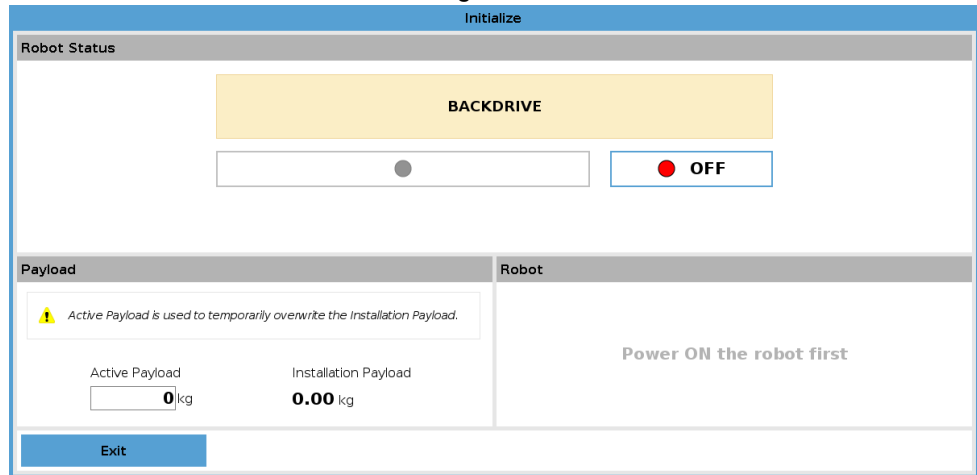

3. Move robot as in Freedrive mode. Joint brakes are released where needed once the Freedrive button is activated.



**NOTICE**

In Backdrive Mode the robot is “heavy” to move around.

**MANDATORY ACTION**

You must test Backdrive mode on all joints.

**Safety settings**

Verify the robot safety settings comply with the robot installation risk assessment.

**Additional safety inputs and outputs are still functioning**

Check which safety inputs and outputs are active and that they can be triggered via PolyScope or external devices.



# 16. Commissioning

**Description** The following tests must be conducted before using the robot application for the first time or after making any modifications.

- Verify all safety inputs and outputs are correctly connected.
- Test all connected safety input and output, including devices common to multiple machines or robots, are functioning as intended.
- Test emergency stop buttons and inputs to verify the robot stops and the brakes engage.
- Test safeguard inputs to verify the robot motion stops. If safeguard reset is configured, check that it functions as intended.
- Look at the initialization screen, activate the reduced input and verify the screen changes.



- Change the operational mode to verify the mode icon changes in top right corner of PolyScope screen.
- Test the 3-position enabling device to verify that pressing to the center on position enables motion in manual mode at a reduced speed.
- If the Emergency Stop outputs are used, press the Emergency Stop push-button and verify that there is a stop of the whole system.
- Test the system connected to Safety I/O Signals in the Installation section to verify the output changes are detected.
- Determine the commissioning requirements of your robot application.

# 17. Transportation

**Description** Only transport the robot in its original packaging. Save the packaging material in a dry place if you want to move the robot later.  
When moving the robot from its packaging to the installation space, hold both tubes of the robot arm at the same time. Hold the robot in place until all mounting bolts are securely tightened at the base of the robot.  
Lift the Control Box by its handle.



## WARNING

Incorrect lifting techniques, or using improper lifting equipment, can lead to injury.

- Avoid overloading your back or other body parts when lifting the equipment.
- Use proper lifting equipment.
- All regional and national lifting guidelines shall be followed.
- Make sure to mount the robot according to the instructions in Mechanical Interface.



## NOTICE

If the robot is attached to 3rd third-party application/ installation during transport, please refer to the following:

- Transporting the robot without its original packaging will void all warranties provided by Universal Robots A/S.
- If the robot is transported as part of a prefabricated solution, securely mounted, and in full compliance with the recommendations outlined below, it is not considered a breach of warranty.

**Disclaimer** Universal Robots cannot be held responsible for any damage caused by transportation of the equipment.  
See the recommendations for transportation without packaging at: [universal-robots.com/manuals](https://universal-robots.com/manuals)

## 17.1. Put in Box Predefined Position

**Description** A predefined position has been added to the user interface in PolyScope 5. This replaces the previous put in box program. Put in box can be used to move the robot into a compact position that is suitable for transportation. The put in box sequence consists of an initial movement to the Zero Position, followed by a movement to the put in box position.

**Put in Box** This is how you find the predefined position:

1. Tab the Installation icon in the top menu.
2. Select Home in the General dropdown.
3. Tab the "Put in Box" button in the UI.

The robot will now start the sequence. When the sequence is finished, the robot is ready to put in the official packaging.

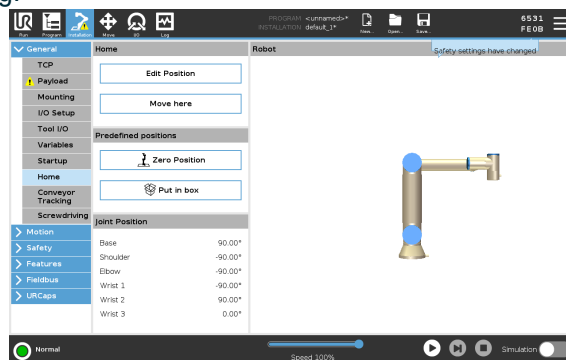

## 17.2. Transportation Without Packaging

**Description** Universal Robots always recommends transporting the robot in its original packaging. These recommendations are written to reduce unwanted vibrations in joints and brake systems and reduce joint rotation. If the robot is transported without its original packaging, then please refer to the following guidelines:

- Fold the robot as much as possible - do not transport the robot in the singularity position.
- Move the center of gravity in the robot as close to the base as possible.
- Secure each tube to a solid surface on two different points on the tube.
- Secure any attached end effector rigidly in 3 axes.

**Trans  
port**

Fold the robot as much as possible.

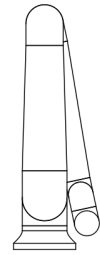
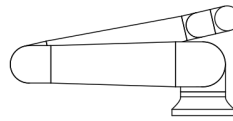

Do not transport extended.  
(singularity position)

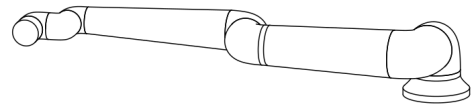
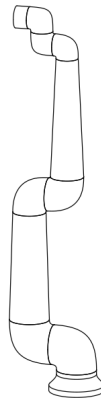

Secure the tubes to a solid surface.  
Secure attached end effector in 3 axes.

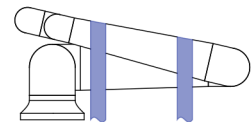
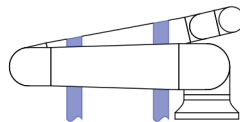

### 17.3. Teach Pendant Storage

**Description**

The operator needs to have a clear understanding about what the e-Stop on the Teach Pendant affects when pressed. For example there can be confusion with a multi-robot installation. It should be made clear if the e-Stop on the Teach Pendant stops the whole installation or only its connected robot. If there could be confusion, store the Teach Pendant such that the e-Stop button is not visible or usable.

## 17.4. Long Term Storage

---

**Description** This section describes general guidelines for long-term storage of robots and spare parts. This applies for all robot generations and spare parts.

A robot is considered long-term stored when it is stored for a period of 6 months or more.

---

**Guidelines** In order to keep the robot and spare parts in its best possible condition, it is recommended to follow normal good practice which is:

- Storage temperature: 10°C - 30°C
  - Humidity: RH 20-60%
  - Universal Robots recommends to unpack and start up robots at least **yearly** and let them run a light load program rotating in all joints at least 90 degrees 5 times in each direction to distribute the lubricants.  
If possible, also mount spare parts joints on an arm and perform the same operation routine.
  - In rare occurrences there may be a need for wiping down the robots after storage to remove any excess lubricants that have migrated out of the sealings.
  - The battery is designed to last for the lifetime of the robot and will not be charged when power is applied to the system. The battery service life is 8 to 10 years, but for e-Series and UR Series it can be replaced.
  - Flash memory can lose their data capacity over time, therefore there is a potential risk that the data on e.g. the SD-card will have to re-flashed.
-

# 18. Maintenance and Repair

---

**Description** Any maintenance work, inspection and calibration shall be conducted in compliance with all safety instructions in this manual, the UR Service Manual, and according to local requirements.  
Repair work shall be done by Universal Robots. Client designated, trained individuals can do repair work, provided they follow the Service Manual.

---

**Safety for Maintenance** The purpose of maintenance and repair is to ensure the system is kept functioning as expected.  
When working on the robot arm or control box, you must observe the procedures and warnings below.



## WARNING

Failure to adhere to any of the safety practices, listed below, can result in injury.

- Unplug the main power cable from the bottom of the Control Box to ensure that it is completely unpowered. Power off any other source of energy connected to the robot arm or Control Box. Take necessary precautions to prevent other persons from powering on the system during the repair period.
- Check the earth connection before re-powering the system.
- Observe ESD regulations when parts of the robot arm or Control Box are disassembled.
- Prevent water and dust from entering the robot arm or Control Box.

**Safety for Maintenance**



**WARNING**

Failure to leave space to accommodate the Control Box with the door fully open can lead to injury.

- Provide at least 915 mm of space to enable the Control Box door to open fully, providing access for servicing.



**WARNING: ELECTRICITY**

Disassembling the Control Box power supply too quickly after switching off, can result in injury due to electrical hazards.

- Avoid disassembling the power supply inside the Control Box, as high voltages (up to 600 V) can be present inside these power supplies for several hours after the Control Box has been switched off.

After troubleshooting, maintenance, and repair work, ensure that safety requirements are fulfilled. Adhere to national or regional work safety regulations. The correct functioning of all safety function settings shall also be tested and validated.

## 18.1. Testing Stopping Performance

**Description**

Test periodically to determine if stopping performance is degraded. Increased stopping times can require safeguarding to be modified, possibly with changes to the installation. If stop time and/or stop distance safety functions are used and are the basis of the risk reduction strategy, no monitoring or testing of stopping performance is required. The robot does continuous monitoring.

## 18.2. Robot Arm Cleaning and Inspection

**Description**

As part of regular maintenance the robot arm can be cleaned, in accordance with the recommendations in this manual and local requirements.

**Cleaning Methods**

To address the dust, dirt, or oil on the robot arm and/or Teach Pendant, simply use a cloth alongside one of the cleaning agents provided below.

**Surface Preparation:** Before applying the below solutions, surfaces may need to be prepared by removing any loose dirt or debris.

**Cleaning agents:**

- Water
- 70% Isopropyl alcohol
- 10% Ethanol alcohol
- 10% Naphtha (Use to remove grease.)

**Application:** The solution is typically applied to the surface that needs cleaning using a spray bottle, brush, sponge, or cloth. It can be applied directly or diluted further depending on the level of contamination and the type of surface being cleaned.

**Agitation:** For stubborn stains or heavily soiled areas, the solution may be agitated using a brush, scrubber, or other mechanical means to help loosen the contaminants.

**Dwell Time:** If necessary, the solution is allowed to dwell on the surface for a up to 5 minutes to penetrate and dissolve the contaminants effectively.

**Rinsing:** After the dwell time, the surface is typically rinsed thoroughly with water to remove the dissolved contaminants and any remaining cleaning agent residue. It's essential to ensure thorough rinsing to prevent any residue from causing damage or posing a safety hazard.

**Drying:** Finally, the cleaned surface may be left to air dry or dried using towels.

**WARNING**

DO NOT USE BLEACH in any diluted cleaning solution.

**WARNING**

Grease is an irritant and can cause an allergic reaction. Contact, inhalation or ingestion can cause illness or injury. To prevent illness or injury, adhere to the following:

- **PREPARATION:**
  - Ensure that the area is well ventilated.
  - Have no food or beverages around the robot and cleaning agents.
  - Ensure that an eye wash station is nearby.
  - Gather the required PPE (gloves, eye protection)
- **WEAR :**
  - Protective gloves: Oil resistant gloves (Nitrile) impermeable and resistant to product.
  - Eye protection is recommended to prevent accidental contact of grease with eyes.
- **DO NOT INGEST.**
- In the event of
  - contact with skin, wash with water and a mild cleaning agent
  - a skin reaction, get medical attention
  - contact with the eyes, use an eyewash station, get medical attention.
  - inhalation of vapors or ingestion of grease, get medical attention
- After grease work
  - clean contaminated work surfaces.
  - dispose responsibly of any used rags or paper used for cleaning.
- Contact with children and animals is prohibited.

**Robot Arm Inspection Plan**

The table below is a checklist of the type of inspections recommended by Universal Robots. Perform inspections regularly as advised in the table. Any referenced parts found to be in an unacceptable state must be rectified or replaced.

Inspection action type			Timeframe		
			Monthly	Biannually	Annually
1	Check flat rings	V		X	
2	Check robot cable	V		X	
3	Check robot cable connection	V		X	
4	Check Robot Arm mounting bolts *	F	X		
5	Check Tool mounting bolts *	F	X		
6	Round Sling	F			X

**Robot Arm Inspection Plan**



**NOTICE**

Using compressed air to clean the robot arm can damage the robot arm components.

- Never use compressed air to clean the robot arm.

**Robot Arm Inspection Plan**

1. Move the Robot Arm to ZERO position, if possible.
2. Turn off and disconnect the power cable from Control Box.
3. Inspect the cable between Control Box and Robot Arm for any damage.
4. Check the base mounting bolts are properly tightened.
5. Check the tool flange bolts are properly tightened.
6. Inspect the flat rings for wear and damage.
  - Replace the flat rings if they are worn out or damaged.



**NOTICE**

If any damage is observed on a robot within the warranty period, contact the distributor where the robot was purchased.

**Inspection**

1. Unmount any tool/s or attachment/s or set the TCP/Payload/CoG according to tool specifications.
2. To move the robot arm in Freedrive:
  - On a 3PE Teach Pendant, rapidly light-press, release, light-press again and keep holding the 3PE button in this position.

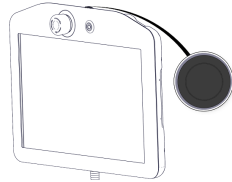

Power button

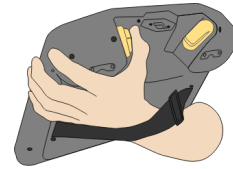

3PE button

3. Pull/Push the robot to a horizontally elongated position and release.

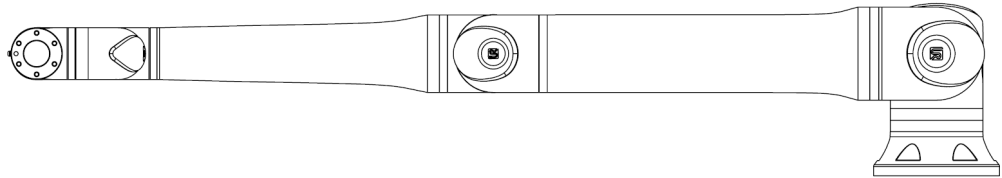

4. Verify the robot arm can maintain the position without support and without activating Freedrive.

## 18.3. Cleaning TP and CB

### Cleaning the Teach Pendant Touch Screen

Use a mild, industrial cleaning agent without thinning agents or any aggressive additives. Do not use an abrasive material to wipe down the screen. Universal Robots does not promote a specific cleaning agent.

### Cleaning the Control Box

Wipe down the Control box with a damp cloth, if necessary. Use the cleaning recommendation listed in the user manual.

**Replace the  
Control box  
Filters**

There is a filter on either side of the control box.

1. Gently remove the outer plastic frame by pulling where the red arrows are, as shown in the images below in figure 3.7. The frame tilts outward.
2. Replace filters.

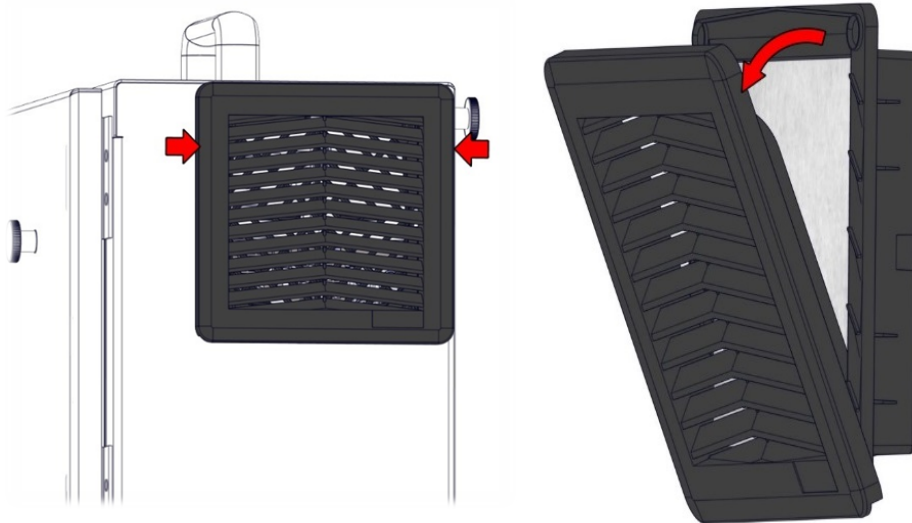
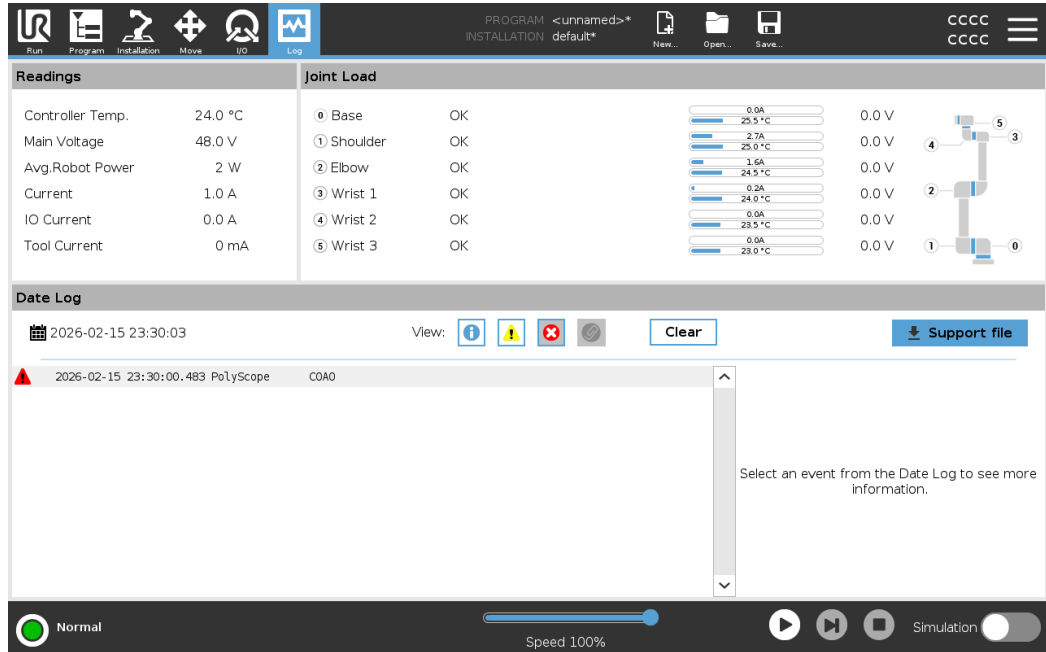

Figure 3.7. Replace the Control box filters.

## 18.4. Log Tab

**Description** The **Log** tab displays information about the robot arm and Control Box.







**Readings and Joint Load** The Readings pane displays Control Box information. The Joint Load pane displays information for each robot arm joint. Each joint displays:

- Temperature
- Load
- Status
- Voltage

**Date Log** The first column displays log entries, categorized by the severity. The second column shows a paperclip if there is an Error Report associated with the log entry. The next two columns display the messages' time of arrival and the source of the message. The last column shows a short description of the message itself. Some log messages are designed to provide more information that is displayed on the right side, after selecting the log entry.

**Message Severity** You can filter messages by selecting the toggle buttons that correspond to the severity of the log entry or by whether an attachment is present. The following table describes message severity.

	Provides general information, such as status of a program, changes of the controller and controller version.
	Issues that may have occurred but the system was able to recover.
	A violation occurs if the safety limit is exceeded. This causes the robot to perform a safety rated stop.
	A fault occurs if there is an unrecoverable error in the system. This causes the robot to perform a safety rated stop.

When you select a log entry, additional information appears on the right side of the screen. Selecting the attachments filter either displays entry attachments exclusively or, displays all entries.

**Saving Error Reports** A detailed status report is available when a paper clip icon appears on the log line.

 **NOTICE**  
The oldest report is deleted when a new one is generated. Only the five most recent reports are stored.

1. Select a log line and tap the Save Report button to save the report to a USB drive.  
You can save the report while a program is running.

You can track and export the following list of errors:

- Emergency stop
- Fault
- Internal PolyScope exceptions
- <sup>1</sup>Robot Stop
- Unhandled exception in URCap
- Violation

The exported report contains: a user program, a history log, an installation and a list of running services.

<sup>1</sup>Robot stop was previously known as "Protective Stop" for Universal Robots robots.

**Technical Support File**

The report file contains information that is helpful to diagnose and reproduce issues. The file contains records of previous robot failures, as well as current robot configurations, programs and installations. The report file can be saved to external USB drive. On the Log screen, tap **Support file** and follow the on-screen instructions to access the function.

**NOTICE**

The export process can take up to 10 minutes depending on USB drive speed and the size of files collected from robot file system. The report is saved as a regular zip file, that is not password protected, and can be edited before sending to technical support.

## 18.5. Program and Installation Manager

### Description

The Program and Installation Manager refers to three icons that allow you to create, load and configure Programs and Installations:

- **New...** Allows you to create a new Program and/or Installation.
- **Open...** Allows you to load a Program and/or Installation.
- **Save...** Offers saving options for a Program and/or Installation.

The File Path displays your current loaded Program name and the type of Installation. File Path changes when you create or load a new Program or Installation. You can have several installation files for a robot. Programs created load and use the active installation automatically.



### To load a program

1. In the Program and Installation Manager, tap **Open...** and select Program.
2. On the Load Program screen, select an existing program and tap Open.
3. In the File Path, verify that the desired program name is displayed.

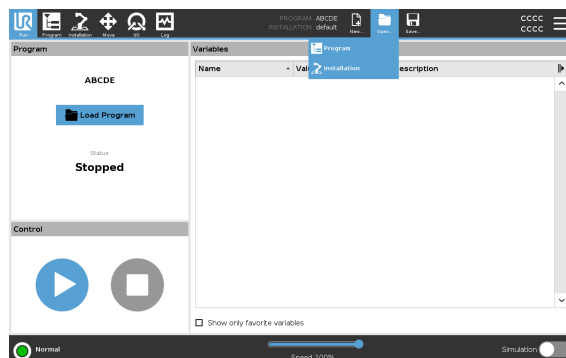

### To load an installation

1. In the Program and Installation Manager, tap **Open...** and select Installation.
2. On the Load Robot Installation screen, select an existing installation and tap Open.
3. In the Safety Configuration box, select Apply and restart to prompt robot reboot.
4. Select Set Installation to set installation for the current Program.
5. In the File Path, verify that the desired installation name is displayed.

**To create a new program**

1. In the Program and Installation Manager, tap **New...** and select Program.
2. On the Program screen, configure your new program as desired.
3. In the Program and Installation Manager, tap **Save...** and select Save All or Save Program As...
4. On the Save Program As screen, assign a file name and tap Save.
5. In the File Path, verify that the new program name is displayed.

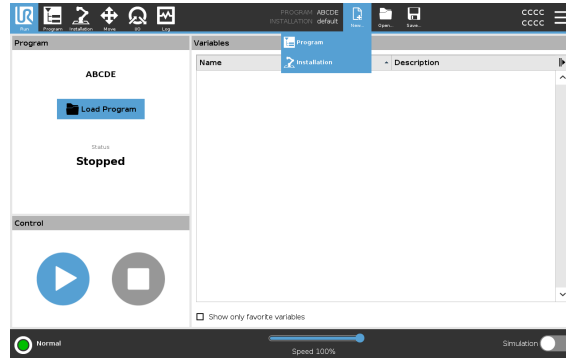

**To create a new installation**

Save your installation for use after powering down the robot.

1. In the Program and Installation Manager, tap **New...** and select Installation.
2. Tap Confirm Safety Configuration.
3. On the Installation screen, configure your new installation as desired.
4. In the Program and Installation Manager, tap **Save...** and select Save Installation As...
5. On the Save Robot Installation screen, assign a file name and tap Save.
6. Select Set Installation to set installation for the current Program.
7. In File Path, verify that the new installation name is displayed.

**To use the save options**

**Save...** Depending on the program/installation you load-create, you can:

- **Save All** to save the current Program and Installation immediately, without the system prompting to save to a different location or different name. If no changes are made to the Program or Installation, the Save All... button appears deactivated.
- **Save Program As...** to change the new Program name and location. The current Installation is also saved, with the existing name and location.
- **Save Installation As...** to change the new Installation name and location. The current Program is saved, with the existing name and location.

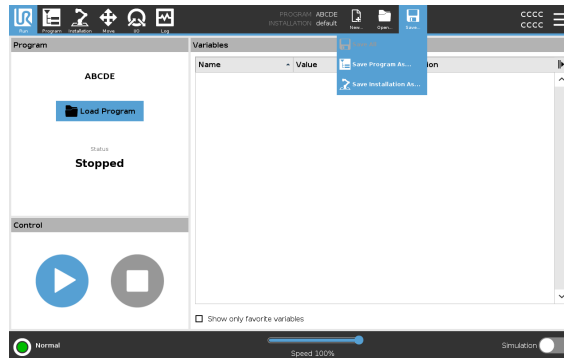

## 18.6. Accessing Robot Data

**Description**

Use the About option to access and display different types of data about the robot. You can display the following types of robot data:

- General
- Version
- Legal

**To display data about the robot**

1. In the Header, tap the **Hamburger** menu.
2. Select **About**.
3. Tap **General** to access the robot's software version, network settings and serial number.

For the other data types you can:

- Tap **Version** to display more detailed data about the robot's software version.
  - Tap **Legal** to display data about the robot's software license/s.
4. Tap **Close** to return to your screen.

## 18.7. New Software Installation

To configure the 3PE TP software

1. On PolyScope, in the Header, tap Installation and select **Safety**.

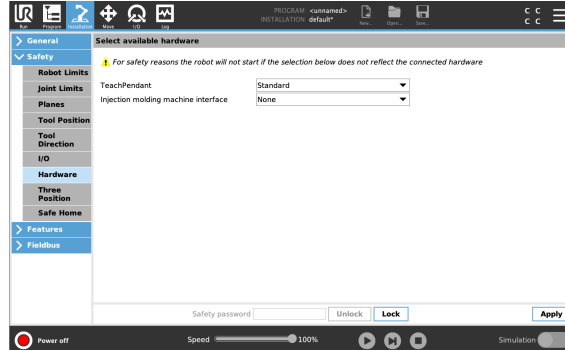

2. Tap **Hardware** and unlock the options on the **Select available hardware** screen. A password is required to unlock this screen.

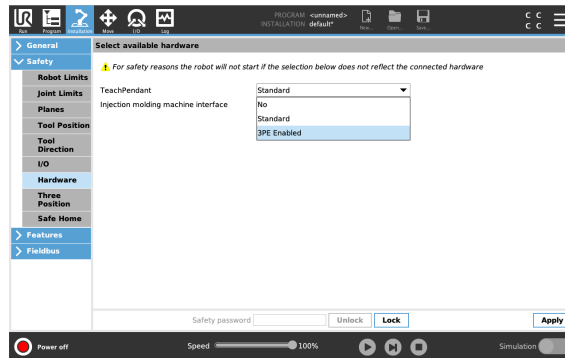

3. In the **Teach Pendant** drop-down list, select **3PE Enabled**.
4. Tap **Apply** to restart the system. PolyScope continues to run.
5. Tap **Confirm Safety Configuration** to complete the 3PE Teach Pendant software installation.
6. As the robot restarts and initializes, light-press the 3PE button and tap **Start** on PolyScope.

# 19. Disposal and Environment

---

**Description** Universal Robots robots must be disposed of in accordance with the applicable national laws, regulations and standards. this responsibility rests with the owner of the robot.

UR robots are produced in compliance with restricted use of hazardous substances to protect the environment; as defined by the European RoHS directive 2011/65/EU. If robots (robot arm, Control Box, Teach Pendant) are returned to Universal Robots Denmark, then the disposal is arranged by Universal Robots A/S.

The disposal fee for UR robots sold on the Danish market is prepaid to DPA-system by Universal Robots A/S. Importers in countries covered by the European WEEE Directive 2012/19/EU must make their own registration to the national WEEE register of their country. The fee is typically less than 1€/robot.

You can find a list of national registers here: <https://www.ewrn.org/national-registers>.  
Search for Global Compliance here: <https://www.universal-robots.com/download>.

**Substances in the UR robot****Robot arm**

- Tubes, Base Flange, Tool mounting bracket: Anodized aluminum
- Joint housings: Powder coated aluminum
- Black band sealing rings: AEM rubber
  - additional slip ring under black band: moulded black plastic
- Endcaps/ lids: PC/ASA Plastic
- Minor mechanical components e.g. screws, nuts, spacers (steel, brass, and plastic)
- Wire bundles with copper wires and minor mechanical components e.g. screws, nuts, spacers (steel, brass, and plastic)

**Robot arm joints (internal)**

- Gears: Steel and grease (detailed in the Service Manual)
- Motors: Iron core with copper wires
- Wire bundles with copper wires, PCB's, various electronic components and minor mechanical components
- Joint seals and O-rings contain a small amount of PFAS which is a compound within PTFE (commonly known as Teflon™).
- Grease: synthetic + mineral oil with a thickener of either lithium complex soap or Urea. Contains molybdenum.
  - Depending on model and date of production, the color of the grease could be yellow, magenta, dark pink, red, green.
  - The Service Manual details the handling precautions and Grease Safety Data Sheets

**Control box**

- Cabinet (enclosure): Powder coated steel
  - Standard Control Box
- Aluminum sheet metal housing (internal to the cabinet). This is also the housing of the OEM controller.
  - Standard Control Box and OEM controller.
- Wire bundles with copper wires, PCB's, various electronic components, plastic connectors, and minor mechanical components e.g. screws, nuts, spacers (steel, brass, and plastic)
- A lithium battery is mounted to a PCB. See the Service Manual for how to remove.

# 20. Declarations and Certifications

# 20.1. Declaration of Incorporation (original)



**EU Declaration of Incorporation (DOI)** (in accordance with 2006/42/EC Annex II B)

<b>Manufacturer:</b> Universal Robots A/S Energivej 51 DK-5260 Odense S Denmark	<b>Person in the Community Authorized to Compile the Technical File:</b> David Brandt Technology Officer, R&D Universal Robots A/S, Energivej 51, DK-5260 Odense S	
<b>Description and Identification of the Partly-Completed Machine(s):</b>		
<b>Product and Function:</b>	Industrial robot multi-purpose multi-axis manipulator with control box & with or without teach pendant Function is determined by the completed machine (robot application or cell with end-effector, intended use and application program).	
<b>Model:</b>	UR3e, UR5e, UR7e, UR10e, UR12e UR16e (e-Series): Below certifications & declaration include: Effective October 2020: Teach Pendants with 3-Position Enabling (3PE TP) & standard Teach Pendants (TP). Effective May 2021: UR10e specification improvement to 12.5kg maximum payload. <b>NOTE:</b> This DOI is NOT applicable when the OEM Controller is used. See control box markings.	
<b>Serial Number:</b>	Starting 2020 5 0 00000 and higher year —   Sequential numbering, restarting at 0 each year e-Series —   3 = UR3e, 5 = UR5e, 7 = UR7e, 0 = UR10e (10kg payload), 1 = UR12e, 2 = UR10e (12.5kg), 6 = UR16e	
<b>Incorporation:</b>	Universal Robots e-Series (UR3e, UR5e, UR7e, UR10e, UR12e and UR16e) shall only be put into service upon being integrated into a final complete machine (robot application or cell), which conforms with the provisions of the Machinery Directive and other applicable Directives.	
It is declared that the above products fulfil, for what is supplied, the following directives as detailed below: When this partly completed machine is integrated and becomes a complete machine, the integrator is responsible for the completed machine fulfilling all applicable Directives, applying the CE mark and providing the Declaration of Conformity (DOC).		
<b>I. Machinery Directive 2006/42/EC</b>	<b>The following essential requirements have been fulfilled:</b> 1.1.2, 1.1.3, 1.1.5, 1.2.1, 1.2.4.3, 1.2.5, 1.2.6, 1.3.2, 1.3.4, 1.3.8.1, 1.3.9, 1.4.1 with 3PE TP, 1.5.1, 1.5.2, 1.5.5, 1.5.6, 1.5.10, 1.6.3, 1.7.2, 1.7.4, 2.2.1.1, 4.1.2.1, 4.1.2.3, 4.1.3, 4.3.3, Annex VI. It is declared that the relevant technical documentation has been compiled in accordance with Part B of Annex VII of the Machinery Directive.	
<b>II. Low-voltage Directive 2014/35/EU</b>	Reference the LVD and the harmonized standards used below.	
<b>III. EMC Directive 2014/30/EU</b>	Reference the EMC Directive and the harmonized standards used below.	
<b>Reference to the harmonized standards used, as referred to in Article 7(2) of the MD &amp; LV Directives and Article 6 of the EMC Directive:</b>		
(I) EN ISO 10218-1:2011 Certification by TÜV Rheinland (I) EN ISO 13732-1:2008 as applicable (I) EN ISO 13849-1:2015 Certification by TÜV Rheinland to 2015; 2023 edition has no relevant changes (I) EN ISO 13849-2:2012 (I) EN ISO 13850:2015	(I) (II) EN 60204-1:2018 as applicable  (II) EN 60529:1991+A1:2000+A2:2013 (I) EN 60947-5-5:1997+A1:2005 +A11:2013+A2:2017 (I) EN 60947-5-8:2020 (III) EN 61000-3-2:2019	(II) EN 60664-1:2007 (III) EN 61000-3-3: 2013 (III) EN 61000-6-1:2019 UR3e & UR5e ONLY (III) EN 61000-6-2:2019 (III) EN 61000-6-3:2007+A1: 2011 UR3e & UR5e ONLY (III) EN 61000-6-4:2019
<b>Reference to other technical standards and technical specifications used:</b>		
(I) ISO 9409-1:2004 [Type 50-4-M6] (I) ISO/TS 15066:2016 as applicable (III) EN 60068-2-1: 2007 (III) EN 60068-2-2:2007	(II) EN 60320-1:2021 (III) EN 60068-2-27:2008 (III) EN 60068-2-64:2008+A1:2019	(II) EN 61784-3:2010 [SIL2] (III) EN 61326-3-1: 2017 [Industrial locations SIL 2]
The manufacturer, or his authorised representative, shall transmit relevant information about the partly completed machinery in response to a reasoned request by the national authorities.		
Approval of full quality assurance system by the notified body Bureau Veritas: ISO 9001 certificate #DK015892 and ISO 45001 certificate #DK015891.		

Odense Denmark, 20 December 2024

*Roberta Nelson Shea*  
Roberta Nelson Shea, Global Technical Compliance Officer

Universal Robots A/S, Energivej 51, DK-5260 Odense S, Denmark  
CVR-nr. 29 13 80 60

Phone +45 8993 8989  
Fax +45 3879 8989

info@universal-robots.com  
www.universal-robots.com

Copyright © 2009-2025 by Universal Robots A/S. All rights reserved.







## 20.2. Certifications UR12e

### Description

Third party certification is voluntary. However, to provide the best service to robot integrators, Universal Robots chooses to certify its robots at the recognized test institutes listed below.

You can find copies of all certificates in the chapter: Certificates.

### Certification

 <p>EN ISO 10218-1 EN ISO 13849-1 www.tuv.com ID 0007000000</p>	TÜV Rheinland	Certificates by TÜV Rheinland to EN ISO 10218-1 and EN ISO 13849-1. TÜV Rheinland stands for safety and quality in virtually all areas of business and life. Founded 150 years ago, the company is one of the world's leading testing service providers.
	TÜV Rheinland of North America	In Canada, the Canadian Electrical Code, CSA 22.1, Article 2-024 requires equipment to be certified by a testing organization approved by the Standards Council of Canada.
	CHINA RoHS	Universal Robots e-Series robots conform to CHINA RoHS management methods for controlling pollution by electronic information products.
	KCC Safety	Universal Robots e-Series robots have been assessed and conform to KCC mark safety standards.
	KC Registration	The Universal Robots e-Series robots have been evaluated for conformity assessment for use in a work environment. Therefore, there is a risk of radio interference when used in a domestic environment.
	Delta	Universal Robots e-Series robots are performance tested by DELTA.

### Supplier Third Party Certification

	Environment	As provided by our suppliers, Universal Robots e-Series robots shipping pallets comply with the ISMPM-15 Danish requirements for producing wood packaging material and are marked in accordance with this scheme.
---	-------------	---



**Manufacturer Test Certification**

	<p>Universal Robots</p>	<p>Universal Robots e-Series robots undergo continuous internal testing and end of line test procedures. UR testing processes undergo continuous review and improvement.</p>
---	-------------------------	--

**Declarations according to EU directives**

Although EU directives are relevant for Europe, some countries outside Europe recognize and/or require EU declarations. European directives are available on the official homepage: <http://eur-lex.europa.eu>.  
According to the Machinery Directive, Universal Robots' robots are partly completed machines, as such a CE mark is not to be affixed.  
You can find the Declaration of Incorporation (DOI) according to the Machinery Directive in the chapter: Declarations and Certificates.

**EU REACH**

Our product includes components, specifically the blue plastic lids (cups) and grey plastic parts, that contain substances listed on the EU REACH Candidate List (>0.1% w/w). For reference, please see the Global Compliance Document available for download on our website.  
This information is provided to comply with EU REACH obligations for articles placed on the EU market. Please use our product as intended and follow all operational and safety instructions provided in this manual. For further details, refer to the official REACH Regulation (Consolidated Text: 32006R1907). If you have questions related to product safety, please contact us at: [ProductCompliance@teradyne-robotics.com](mailto:ProductCompliance@teradyne-robotics.com).

## 20.3. Certificates UR12e

TÜV Rheinland

Page 1

# Certificate

**Certificate no.** T 72503111 0001

<p><b>License Holder:</b>                  Universal Robots A/S                  Energivej 51                  5260 Odense S                  Denmark</p>	<p><b>Manufacturing Plant:</b>                  See additional page(s) for the listing of 3 factories</p>
<p><b>Report Number:</b> 31875333 027</p>	<p><b>Client Reference:</b> Roberta Nelson Shea</p>
<p><b>Certification acc. to:</b> EN ISO 10218-1:2011                  EN ISO 13849-1:2015</p>	

**Product Information**

**Certified Product:** Industrial Robot

**Model Designation:** UR3, UR5, UR10, UR15, UR20, UR30, UR3e, UR5e, UR7e, UR10e, UR12e, UR16e, UR8 Long, UR18

**Technical Data:** Rated Voltage: AC 100-200V, 50/60Hz or AC 200-240V, 50/60Hz  
 Rated Current: 15A or 8A  
 Protection Class: I

**Special Remarks:** The robot is only a component in a final robot application, collaborative or non-collaborative. The final application/installation must comply with EN ISO 10218-2. Certificate is only valid within used in conjunction with the UR Control Box, with or without a UR Teach Pendant. Includes optional IMMI accessory. The following safety functions have been evaluated and determined to meet PLd Cat. 3 per EN ISO 13849-1:2015:

1- Emergency Stop;	2- Safeguard Stop
3- Joint Position Limit;	4- Joint Speed Limit
5- Pose Limit;	6- Cartesian Speed Limit
7- Force Limit;	8- Momentum Limit
9- Power Limit;	10- Stopping Time Limit
11- Stopping Distance Limit;	12- System Emergency Stop Output
13- Robot Moving Digital Output;	
14- Robot Not Stopping Digital Output	
15- Reduced Mode Digital Output;	
16- Not Reduced Mode Digital Output	
17- 3 Position Enabling Device INPUT	

Refer to product manual for additional information. Must be installed and programmed in accordance with the manufacturer's instructions.

**Remarks:** Replaces Certificate T72501672.

**Appendix:** 1, 1-68

© TÜV, TÜV and TÜV are registered trademarks. Utilization and application requires prior approval.

TÜV Rheinland of North America, Inc.  
 400 Beaver Brook Rd, Boxborough, MA 01719  
 Tel +1 (978) 266 9500, Fax +1 (978) 266-9992

www.tuv.com



Copyright © 2009-2025 by Universal Robots A/S. All rights reserved.

China  
RoHS

Management Methods for Controlling Pollution  
by Electronic Information Products  
Product Declaration Table For Toxic or Hazardous Substances

表1 有毒有害物质或元素名称及含量标识格式



Product/Part Name 产品/部件名称	Toxic and Hazardous Substances and Elements 有毒有害物质或元素					
	铅 Lead (Pb)	汞 Mercury (Hg)	镉 Cadmium (Cd)	六价 Hexavalent Chromium (Cr+6)	多溴联苯 Polybrominated biphenyls (PBB)	多溴二苯醚 Polybrominated diphenyl ethers (PBDE)
UR Robots 机器人：基本系统 UR3 / UR5 / UR10 / UR3e / UR5e / UR7e UR10e/UR12e/ UR16e /UR15e/ UR20 / UR30	X	O	X	O	X	X

O: Indicates that this toxic or hazardous substance contained in all of the homogeneous materials for this part is below the limit requirement in SJ/T11363-2006.  
O: 表示该有毒有害物质在该部件所有均质材料中的含量均在SJ/T 11363-2006规定的限量要求以下。  
X: Indicates that this toxic or hazardous substance contained in at least one of the homogeneous materials used for this part is above the limit requirement in SJ/T11363-2006.  
X: 表示该有毒有害物质至少在该部件的某一均质材料中的含量超出SJ/T 11363-2006规定的限量要求。  
(企业可在此处·根据实际情况对上表中打“X”的技术原因进行进一步说明。)

Items below are wear-out items and therefore can have useful lives less than environmental use period:  
下列项目是损耗品,因而它们的有用环境寿命可能短于基本系统和可选项目的使用时间:  
Drives, Gaskets, Probes, Filters, Pins, Cables, Stiffener, Interfaces  
电子驱动器, 垫圈, 探针, 过滤器, 别针, 缆绳, 加强筋, 接口  
Refer to product manual for detailed conditions of use.  
详细使用情况请阅读产品手册。

Universal Robots encourages that all Electronic Information Products be recycled but does not assume responsibility or liability.  
Universal Robots 鼓励回收再循环利用所有的电子信息产品,但 Universal Robots 不负任何责任或义务

To the maximum extent permitted by law, Customer shall be solely responsible for complying with, and shall otherwise assume all liabilities that may be imposed in connection with, any legal requirements adopted by any governmental authority related to the Management Methods for Controlling Pollution by Electronic Information Products (Ministry of Information Industry Order #39) of the Peoples Republic of China otherwise encouraging the recycle and use of electronic information products. Customer shall defend, indemnify and hold Universal Robots harmless from any damage, claim or liability relating thereto. At the time Customer desires to dispose of the Products, Customer shall refer to and comply with the specific waste management instructions and options set forth at [www.universal-robots.com/about-universal-robots/social-responsibility](http://www.universal-robots.com/about-universal-robots/social-responsibility) and [www.teradyne.com/company/corporate-social-responsibility](http://www.teradyne.com/company/corporate-social-responsibility), as the same may be amended by Teradyne or Universal Robots.

Copyright © 2009-2025 by Universal Robots A/S. All rights reserved.

KC Safety



**자율안전확인 신고증명서**

신청인	사업장명	Universal Robots A/S	사업장관리번호	2016E110079
	사업자등록번호	016E110079	대표자 성명	Klaus Vestergaard
	소재지	Energivej 25, 5260 Odense S, Denmark		
자율안전인증대상 기계		기구명	산업용로봇	
형식(규격)	UR10e	용량(등급)	6 axis	
자율안전확인번호	18-AB2EQ-01602			
제조사	Universal Robots A/S			
소재지	Energivej 25, 5260 Odense S, Denmark			

「산업안전보건법」 제35조제1항 및 같은 법 시행규칙 제61조제3항에 따라 자율안전확인 신고증명서를 발급합니다.

2018년 11월 06일



한국산업안전보건공단 서울지역본부장



KC  
Registration

8ED6-B666-998D-8738

방송통신기자재등의 적합등록 필증 Registration of Broadcasting and Communication Equipments	
상호 또는 성명 <small>Trade Name or Registrant</small>	Universal Robots A/S
기자재명칭(제품명칭) <small>Equipment Name</small>	UR e-Series robot
기본모델명 <small>Basic Model Number</small>	UR10e
파생모델명 <small>Series Model Number</small>	
등록번호 <small>Registration No.</small>	R-R-URK-UR10e
제조사/제조(조립)국가 <small>Manufacturer/Country of Origin</small>	Universal Robots A/S / 덴마크
등록연월일 <small>Date of Registration</small>	2018-10-23
기타 <small>Others</small>	
위 기자재는 「전파법」 제58조의2 제3항에 따라 등록되었음을 증명합니다. It is verified that foregoing equipment has been registered under the Clause 3, Article 58-2 of Radio Waves Act.	
2018년(Year) 10월(Month) 23일(Day)	
국립전파연구원장  Director General of National Radio Research Agency	
※ 적합등록 방송통신기자재는 반드시 "적합성평가표시" 를 부착하여 유통하여야 합니다. 위반시 과태료 처분 및 등록이 취소될 수 있습니다.	

Copyright © 2009-2025 by Universal Robots A/S. All rights reserved.



**Environment**

**Climatic and mechanical assessment**



<b>Client</b> Universal Robots A/S Energivej 25 5260 Odense S Denmark	<b>Force Technology project no.</b> 117-32120
<b>Product identification</b> UR 3 robot arms UR 3 control boxes with attached Teach Pendants. UR 5 robot arms UR5 control boxes with attached Teach Pendants. UR10 robot arms: UR10 control boxes with attached Teach Pendants. See reports for details.	
<b>Force Technology report(s)</b> DELTA project no. 117-28266, DANAK-19/18069 DELTA project no. 117-28086, DANAK-19/17068	
<b>Other document(s)</b>	
<b>Conclusion</b> The three robot arms UR3, UR5 and UR10 including their control boxes and Teach Pendants have been tested according to the below listed standards. The test results are given in the Force Technology reports listed above. The tests were carried out as specified and the test criteria for environmental tests were fulfilled in general terms with only a few minor issues (see test reports for details).  IEC 60068-2-1, Test Ae; -5 °C, 16 h IEC 60068-2-2, Test Be; +35°C, 16h IEC 60068-2-2, Test Be; +50°C, 16 h IEC 60068-2-64, Test Fh; 5 – 10 Hz: +12 dB/octave, 10-50 Hz 0.00042 g <sup>2</sup> /Hz, 50 – 100 Hz: -12 dB/octave, 1,66 grms, 3 x 1½ h IEC 60068-2-27, Test Ea, Shock; 11 g, 11 ms, 3 x 18 shocks	
<b>Date</b>  Hørsholm, 25 August 2017	<b>Assessor</b>   Andreas Wendelboe Højsgaard M.Sc.Eng.

DELTA – a part of FORCE Technology - Venlighedsvej 4 - 2970 Hørsholm - Denmark - Tel. +45 72 19 40 00 - Fax +45 72 19 40 01 - www.delta.dk

Copyright © 2009-2025 by Universal Robots A/S. All rights reserved.

# 21. Safety Functions Table

## Description

Universal Robots safety functions and safety I/O are PLd Category 3 (ISO 13849-1), where each safety function has a PFH value less than 1.8E-07.

The PFH values are updated to include greater design flexibility for supply chain resilience.

For safety I/O the resulting safety function including the external device, or equipment, is determined by the overall architecture and the sum of all PFHs, including the UR robot safety function PFH.

If any safety function limit is exceeded or a fault is detected in a safety function or safety-related part of the control system, UR defines the safe state as a stop with removal of drive power (either a stop category 1 or 0<sup>4</sup> immediate removal of power).



### NOTICE

The Safety Functions tables presented in this chapter are simplified. You can find the comprehensive versions of them here: <https://www.universal-robots.com/support>

## SF1

1, 2, 3, 4

### Emergency Stop (ISO 13850)

Description	What happens?	Tolerance	Affects
Pressing the Estop PB on the pendant <sup>1</sup> or the External Estop (if using the Estop Safety Input) results in a Stop Cat 1 <sup>4</sup> with power removed from the robot actuators and the tool I/O. Controller I/O go “low”. Command <sup>1</sup> all joints to stop and upon all joints coming to a monitored standstill state, power is removed. See Stop Time & Stop Distance Safety Functions <sup>5</sup> . <b>ONLY USE FOR EMERGENCY PURPOSES</b> , not to be used for safeguarding because it requires a manual action.	Stop Category 1 (IEC 60204-1)	--	Robot, robot tool I/O, and controller I/O

## SF2

3, 5

### Safeguard Stop

(Protective Stop according to ISO 10218-1\*)

\*Prior to 2006, this was called “safety stop” or “safeguard stop”

Description	What happens?	Tolerance	Affects
This safety function is initiated by an external protective device using safety inputs which will initiate a Stop Cat 2 <sup>4</sup> . The purpose is to protect people from injury, as compared to protecting the robot, equipment, or products. The tool I/O are unaffected by the safeguard stop. If an enabling device is connected, it is possible to configure the safeguard stop to function in automatic mode ONLY. See the Stop Time and Stop Distance Safety Functions. <sup>5</sup>	Stop Category 2 (IEC 60204-1) SS2 stop (as described in IEC 61800-5-2)	--	Robot

### Safeguard Stop Reset

Description	What happens?	Tolerance	Affects
When configured for Safeguard Reset and the external reset connections transition from low to high, safeguard stop resets. Safety input to initiate a reset of SF2.	Reset Input to SF2	--	Robot

**SF3  
Joint Position  
Limit  
(software-  
based axis  
limiting)**

Description	What happens?	Tolerance	Affects
<p>Sets upper and lower limits for the allowed joint positions. Stopping time and distance is not a considered as the limit(s) will not be violated. Each joint can have its own limits.</p> <p><i>Directly limits the set of allowed joint positions that the joints can move within. It is safety-rated soft axis limiting &amp; space limiting, according to ISO 10218-1:2011, 5.12.3.</i></p>	<p><b>Will not allow motion to exceed any limit settings.</b></p> <p>Speed could be reduced so motion will not exceed any limit.</p> <p>A robot stop will be initiated to prevent exceeding any limit.</p>	5°	Joint (each)

**SF4  
Joint  
Speed  
Limit**

Description	What happens?	Tolerance	Affects
<p>Sets an upper limit for the joint speed. Each joint can have its own limit. This safety function has the most influence on energy transfer upon contact (clamping or transient).</p> <p><i>Directly limits the set of allowed joint speeds which the joints are allowed to perform. It is used to limit fast joint movements, e.g. risks related to singularities.</i></p>	<p><b>Will not allow motion to exceed any limit settings.</b></p> <p>Speed could be reduced so motion will not exceed any limit.</p> <p>A robot stop will be initiated to prevent exceeding any limit.</p>	1.15 °/s	Joint (each)

**Joint Torque  
Limit**

Exceeding the internal joint torque limit (each joint) results in a Cat 0 Stop<sup>4</sup>. This safety function is not accessible to the user; it is a factory setting. It is NOT shown as here because there are no user settings.

**SF5  
Called various  
names:  
Pose Limit  
Tool Limit,  
Orientation  
Limit, Safety  
Planes,  
Safety  
Boundaries**

Description	What happens?	Tolerance	Affects
<p>Monitors the TCP Pose (position and orientation) and will prevent exceeding a safety plane or TCP Pose Limit.</p> <p>Multiple pose limits are possible (tool flange, elbow, and up to 2 configurable tool offset points with a radius)</p> <p>Orientation restricted by the deviation from the feature Z direction of the tool flange OR the TCP.</p> <p><i>Two parts. (1) is the safety planes for limiting the possible TCP positions. (2) is the TCP orientation limit, which is entered as an allowed direction and a tolerance. This provides TCP and wrist inclusion/exclusion zones due to the safety planes.</i></p>	<p>Will not allow motion to exceed any limit settings. Speed or torques could be reduced so motion will not exceed any limit set for SF 5, SF 6, SF 7 or SF 8.</p>	3° 40 mm	TCP Tool flange Elbow

**SF6  
Speed  
Limit TCP  
& Elbow**

Description	What happens?	Tolerance	Affects
Monitors the <b>TCP</b> and <b>elbow</b> speed to prevent exceeding a speed limit. Equivalent to monitoring the whole arm as the sections between the TCP and elbow cannot move faster than the endpoints of these sections.	A robot stop will be initiated to prevent exceeding any limit.  <b>Will not allow motion to exceed any limit settings.</b>	50 mm/s	TCP

**SF7  
Force  
Limit  
(TCP)**

Description	What happens?	Tolerance	Affects
The Force Limit is the force exerted by the robot at the TCP (tool center point) and " <b>elbow</b> ". The safety function continuously calculates the torques allowed for each joint to stay within the defined force limit for both the TCP & the elbow. The joints control their torque output to stay within the allowed torque range. This means that the forces at the TCP or elbow will stay within the defined force limit. When a stop is initiated by the Force Limit SF, the robot will stop. The UR standard controller will cause motion to "back-off" to the position before the force limit was exceeded. This "back-off" is not part of the safety function as it is done by the standard controller. The safety controller has a fixed time (part of the response time) allowed before a robot stop is initiated.	A robot stop will be initiated to prevent exceeding any limit.  <b>Will not allow motion to exceed any limit settings.</b>	25 N	TCP

**wrist  
clamping  
torque**

Force Limits may be exceeded by the three wrist joints if the "wrist clamping torque" safety function is disabled.

**SF8  
Momentum  
Limit**

Description	What happens?	Tolerance	Affects
The momentum limit is very useful for limiting transient impacts.  <i>The Momentum Limit affects the entire robot.</i>	A robot stop will be initiated to prevent exceeding any limit.  <b>Will not allow motion to exceed any limit settings.</b>	3 kg m/s	Robot

**SF9  
Power  
Limit**

Description	What happens?	Tolerance	Affects
This function monitors the mechanical work (sum of joint torques times joint angular speeds) performed by the robot, which also affects the current to the robot arm as well as the robot speed. This safety function dynamically limits the current/torque but maintains the speed.	Dynamic limiting of the current/torque	10 W	Robot

**SF10  
UR Robot  
Stop  
Outputs**

Description	What Happens	Tolerance	Affects
<p>When configured for a robot stop output and there is a robot stop, the dual outputs are LOW. If there is no robot stop initiated, dual outputs are high. Pulses are not used but they are tolerated. For an integrated safety function, see footnote.<sup>6</sup></p> <p>These dual outputs change state for any external Estop that is connected to configurable safety inputs where this input is configured as an Emergency Stop input.</p> <p>For the Stop Output, validation is performed at the external equipment, as the UR output is an input to this external stop safety function for external equipment.</p>	<p>Dual outputs go low in event of a stop if configurable outputs are set</p>	<p>N/A</p>	<p>External connection to logic and/or equipment</p>
<div style="border: 1px solid black; padding: 5px;">  <p><b>NOTICE</b></p> <p>This stop output is not connected to the IMMI (Injection Moulding Machine Interface), to prevent having an unrecoverable stop.</p> </div>			

**SF11  
"Moving"  
Safety  
Function  
with Digital  
Outputs**

Description	What Happens	Tolerance	Affects
<p>Whenever the robot is moving (motion underway), the dual digital outputs are LOW. Outputs are HIGH when no movement.</p> <p>Functional safety is for what is within the UR robot. For an integrated safety function, see footnote.<sup>6</sup></p>	<p>Dual outputs are low during motion and high when no movement.</p>	<p>N/A</p>	<p>External connection to logic and/or equipment</p>

**SF12  
"Not  
stopping"  
Safety  
Function  
with Digital  
Outputs**

Description	What happens?	Tolerance	Affects
<p>Whenever the robot is STOPPING (in process of stopping or in a stand-still condition) the dual digital outputs are HIGH. When outputs are LOW, robot is NOT in the process or stopping and NOT in a stand-still condition. For an integrated safety function, see footnote.<sup>6</sup></p>	<p>Dual outputs are high when robot is either in the process of stopping or at a stand-still state</p>	<p>N/A</p>	<p>External connection to logic and/or equipment</p>

**SF13  
"Reduced  
Active"  
Safety  
Function  
with Digital  
Outputs**

Description	What happens?	Tolerance	Affects
<p>When reduced settings are active (or initiated) for safety functions, the dual digital outputs are LOW. The functional safety is for what is within the UR robot. For the integrated safety function, see footnote.<sup>6</sup></p>	<p>Dual outputs are low when reduced settings are active</p>	<p>N/A</p>	<p>External connection to logic and/or equipment</p>

**SF14  
"Reduced  
Not Active"  
Safety  
Function  
with Digital  
Outputs**

Description	What happens?	Tolerance	Affects?
<p>Whenever the robot reduced settings for safety functions are NOT active (or not initiated), the digital outputs are LOW.</p> <p>The functional safety rating is for what is within the UR robot.</p> <p>For the integrated safety function, see below footnote.<sup>6</sup></p>	<p>Dual outputs are low when reduced settings are NOT active.</p>	<p>N/A</p>	<p>External connection to logic and/or equipment.</p>

Copyright © 2009-2025 by Universal Robots A/S. All rights reserved.

**“Reduced Active” Input SF parameter settings change**

Description	Affects
Reduced is not a mode. It is a change of settings initiated: <ul style="list-style-type: none"> <li>internally by a safety plane/ boundary (starts when at 2cm of the plane and reduced settings are achieved within 2cm of the plane) or</li> <li>externally by use of an external input, which will achieve reduced settings within 500ms of the triggering input.</li> </ul> When the external connections are Low, Reduced Mode is initiated. “Reduced Active” means that all reduced limits are ACTIVE. <p>Reduced is not a safety function. Reduced is a means of parameterization of safety functions.</p> <p>Reduced is a state change affecting the settings of the following safety functions: joint position, joint speed, TCP pose, TCP speed, TCP force, momentum, power, stopping time, &amp; stopping distance.</p> <p>Verify and validate all parameter settings for the robot application.</p>	<b>Robot</b>

**SF15 Stopping Time Limit**

Description	What happens?	Tolerances	Affects
Real time monitoring of conditions such that the stopping time limit will not be exceeded. Robot speed is limited to ensure that the stop time limit is not exceeded. <sup>7</sup>	Will not allow the actual stopping to exceed the limit setting.	50 ms	Robot

**SF16 Stopping Distance Limit**

Description	What happens?	Tolerances	Affects
Real time monitoring of conditions such that the stopping distance limit will not be exceeded. Robot speed is limited to ensure that the stop distance limit will not be exceeded. <sup>7</sup>	Causes decrease in speed or a robot stop so as NOT to exceed the limit.	40 mm	Robot

**SF17 Safe Home Position "monitored position"**

Description	What happens?	Tolerances	Affects
Safety function which monitors a safety-rated output, such that it ensures that the output can only be activated when the robot is in the configured and monitored “safe home position”. A stop cat 0 is initiated if the output is activated when the robot is not in the configured position.	The “safe home output” is only activated when the robot is in the configured “safe home position”	1.7 °	<b>External connection to logic and/or equipment</b>

**Mode switch INPUT**

Description	What happens?	Affects
When the external connections are Low, Automatic Mode (running) is active. When High, mode is programming/ teach. <b>Recommendation:</b> Use with an enabling device, i.e. UR Teach Pendant with an integrated 3-position enabling device. When in teach/program, initially the TCP speed is limited to 250mm/s. Speed can manually be increased using the TP “speed-slider”, but upon activation of the enabling device, the speed limitation will reset to 250mm/s.	Input to SF2	Robot

**SF18  
(3-position  
enabling)  
Safety  
Function<sup>8</sup>  
Inputs**

Description	What happens?	Tolerance	Affects
<p>A 3-position enabling device<sup>9</sup> has 3 switch positions: <b>off, on, off</b> (in order of actuation when squeezing). When released completely, the device is off. When pressed/squeezed to the centre position, it is on. Completely pressing (squeezing) results in an off state. When the 3P enabling device is "ON", motion is enabled.</p> <p><b>When in Manual Mode</b> and when an external Enabling Device connection is OFF, internally the safety system initiates SF2, which is a Stop Category 2.</p> <p><b>Recommendation:</b> Use with a mode switch as a safety input.<sup>10</sup></p>	<p><b>In manual mode, when the SF18 Input is LOW, SF2 is triggered internally</b></p> <p>Stop Category 2 (IEC 60204-1) SS2 (IEC 61800-5-2)</p>	N/A	<p><b>Robot and external connection to SF19 &amp; SF20</b></p>

**SF19  
3PE (3-  
position  
enabling)  
Safety  
Function<sup>8</sup>  
with Digital  
Outputs**

Description	What happens?	Tolerance	Affects
<p><b>In Automatic Mode ("running"), SF19's outputs are HIGH.</b></p> <p><b>In Manual Mode</b> and when any Enabling Device<sup>11</sup> is in the OFF state (not in the centre-ON position, meaning the enabling device is released or fully pressed), a SF2 is triggered causing a Stop Category 2 (SS2) and SF19's outputs are Low.<sup>8</sup></p> <p><b>In Manual mode, when Freedrive and the 3PE are used:</b></p> <ul style="list-style-type: none"> <li>• <b>If Freedrive is activated</b> and             <ul style="list-style-type: none"> <li>• <u>ALL</u> 3PE are in the OFF state, SF19's outputs are HIGH.</li> <li>• <u>Any</u> 3PE is in the ON state, SF19's outputs are LOW.</li> </ul> </li> <li>• <b>If Freedrive is not activated</b>, and             <ul style="list-style-type: none"> <li>• <u>ALL</u> 3PE are in the ON state, SF19's outputs are HIGH.</li> <li>• <u>Any</u> 3PE is in the OFF state, SF19's outputs are LOW.</li> </ul> </li> </ul>	<p><b>In manual mode, when the 3PE is in the Off state, the outputs are LOW and SF2 is triggered internally</b></p> <p>Stop Category 2 (IEC 60204-1) SS2 (IEC 61800-5-2)</p>	N/A	<p><b>External connection to logic and/or equipment</b></p>



**SF20  
3PE (3-  
position  
enabling)  
"NOT state"  
Safety  
Function<sup>8</sup>  
with Digital  
Outputs**

Description	What happens?	Tolerance	Affects
<p>In <b>Automatic Mode ("running")</b>, SF20's outputs are <b>LOW</b>.                      In <b>Manual Mode</b> and when any Enabling Device<sup>11</sup> is in the OFF state (not in the centre-ON position, meaning the enabling device is released or fully pressed), SF20's outputs are High.<sup>7</sup></p> <p>In Manual mode, when Freedrive and the 3PE are used:</p> <ul style="list-style-type: none"> <li>• <b>If Freedrive is activated</b> and:                             <ul style="list-style-type: none"> <li>• <u>ALL</u> 3PE are in the OFF state, SF20's outputs are LOW.</li> <li>• <u>Any</u> 3PE is in the ON state, then SF20's outputs are HIGH.</li> </ul> </li> <li>• <b>If Freedrive is not activated</b>, and:                             <ul style="list-style-type: none"> <li>• <u>ALL</u> 3PE are in the ON state, SF20's outputs are LOW.</li> <li>• <u>Any</u> 3PE is in the OFF state, SF20's outputs are HIGH.</li> </ul> </li> </ul> <p><b>Note:</b> SF20 is an inverted version of the SF19 where the output state is logically reversed compared to SF19.</p>	<p><b>In manual mode, when the 3PE is in the Off state, the outputs are HIGH.</b></p>	<p>N/A</p>	<p><b>External connection to logic and/or equipment</b></p>

**Table 1  
footnotes**

- <sup>1</sup>**Communications** between the Teach Pendant, controller & within the robot are SIL 2 for safety data (per IEC 61784-3).
- <sup>2</sup>**Estop validation:** The pendant Estop pushbutton is evaluated within the pendant, then communicated<sup>1</sup> to the safety controller by SIL2 communications. To validate the pendant Estop functionality, press the Pendant Estop pushbutton and verify that an Estop results. This validates that the Estop is connected within the pendant, the estop functions as intended, and the pendant is connected to the controller.
- <sup>3</sup>**If a robot safety function** is “integrated” or “connected” with external equipment, devices or logic, the resulting integrated safety function has a PFH that is the sum of all PFH values, including the PFH value of the robot safety function.
- <sup>4</sup>**Stop Categories** according to IEC 60204-1 (NFPA79). For the Estop, only stop category 0 and 1 are allowed.
- **Stop Category 0 & 1** result in the removal of drive power, with stop cat 0 being IMMEDIATE & stop cat 1 being a controlled stop (e.g. decelerate to a stop then removal of drive power).
  - **Stop Category 2** is a stop where drive power is NOT removed. Stop category 2 is defined in IEC 60204-1. Descriptions of STO, SS1 & SS2 are in IEC 61800-5-2. With UR, a stop category 2 maintains the trajectory & retains power to the drives after stopping.
- <sup>5</sup> **Stop Time & Stop Distance** Safety Functions should be used. When used, there is no need for periodic verification of stopping performance.
- <sup>6</sup> **If a robot safety function** is “integrated” or “connected” with external equipment, devices or logic, the resulting integrated safety function has a PFH that is the sum of all PFH values, including the PFH value of the robot safety function.
- <sup>7</sup> The stopping capability of the robot in the given motion(s) is continuously monitored to prevent motions that would exceed the stopping limit. If the time needed to stop the robot is at risk of exceeding the time limit, the speed of motion is reduced to ensure the limit is not exceeded. A stop will be initiated to prevent exceeding the limit.
- <sup>8</sup> For the integrated functional safety rating with an external safety-related control system, add the PFH of this safety-related output to the PFH of the external safety-related control system. The safety function and its triggering of a stop are included in the PFH value for this SF.
- <sup>9</sup> The enabling device can be on the teach pendant or external connected to the Enabling Function input (SF18).
- <sup>10</sup> Use of an external mode switch is recommended when using a 3-position enabling device. If an external mode switch is not used and connected to the safety inputs, then the robot mode will be determined by the User Interface. If the User Interface is in
- “run mode”, the enabling function will not be active.
  - “programming mode”, the enabling function will be active. Password protection for changing the mode can be configured.
- <sup>11</sup> If any 3PE enabling device is released or fully pressed, the 3-position enabling safety function is OFF (not in the Center ON position).
- <sup>12</sup> ISO 10218:2025 removed the term “collaborative operation”.
- <sup>13</sup> Tools attached to the robot’s tool flange may still come into contact with the robot’s lower arm link

## 21.1. Table 1a

### Reduced SF parameter settings change

Description	Affects
<p>The reduced configuration can be initiated by a safety plane/ boundary (starts at 2cm of the plane and reduced settings are achieved within 2cm of the plane) or by use of an input to initiate (will achieve reduced settings within 500ms). When the external connections are Low, Reduced is initiated. Reduced configuration means that ALL reduced limits are ACTIVE.</p> <p>Reduced is not a safety function, rather it is a state change affecting the settings of the following safety function limits: joint position, joint speed, TCP pose limit, TCP speed, TCP force, momentum, power, stopping time, and stopping distance. A reduced configuration is a means of parametrization of safety functions in accordance with ISO 13849-1. All parameter values need to be verified and validated as to whether they are appropriate for the robot application.</p>	Robot

### Safeguard Reset

Description	Affects
<p>When configured for Safeguard Reset and the external connections transition from low to high, the safeguard stop RESETS. Safety input to initiate a reset of safeguard stop safety function.</p>	Robot

### 3-Position Enabling Device INPUT

Description	Affects
<p>When the external Enabling Device connections are Low, a Safeguard Stop (SF2) is initiated.</p> <p>Recommendation: Use with a mode switch as a safety input. If a mode switch is not used and connected to the safety inputs, then the robot mode will be determined by the User Interface. If the User Interface is in:</p> <ul style="list-style-type: none"> <li>• “running mode”, the enabling device will not be active.</li> <li>• “programming mode”, the enabling device will be active. It is possible to use password protection for changing the mode by the User Interface.</li> </ul>	Robot

### Mode switch INPUT

Description	Affects
<p>When the external connections are Low, Operation Mode (running/ automatic operation in automatic mode) is in effect. When High, mode is programming/ teach. Recommendation: Use with an enabling device, for example a UR e-Series Teach Pendant with an integrated 3-position enabling device.</p> <p>When in teach/program, initially both TCP speed and elbow speed will be limited to 250mm/s. The speed can manually be increased by using the pendant user interface “speed-slider”, but upon activation of the enabling device, the speed limitation will reset to 250mm/s.</p>	Robot

### Freedrive INPUT

Description	Affects
<p>Recommendation: Use with 3PE TP and/or 3 Position Enabling Device INPUT. When Freedrive INPUT is High, the robot will only enter Freedrive if the following conditions are satisfied:</p> <ul style="list-style-type: none"> <li>• 3PE TP button is not pressed</li> <li>• 3 Position Enabling Device INPUT either not configured or not pressed (INPUT Low)</li> </ul>	Robot

## 21.2. Table 2

### Description

UR e-Series robots comply with ISO 10218-1:2011 and the applicable portions of ISO/TS 15066. It is important to note that most of ISO/TS 15066 is directed towards the integrator and not the robot manufacturer. ISO 10218-1:2011, clause 5.10 collaborative operation details 4 collaborative operation techniques as explained below. It is very important to understand that collaborative operation is of the APPLICATION when in AUTOMATIC mode.

### Collaborative Operation 2011 edition, clause 5.10.2

Technique	Explanation	UR e-Series
Safety-rated monitored stop	Stop condition where position is held at a standstill and is monitored as a safety function. Category 2 stop is permitted to auto reset. In the case of resetting and restarting operation after a safety -rated monitored stop, see ISO 10218-2 and ISO/TS 15066 as resumption shall not cause hazardous conditions.	UR robots' safeguard stop is a safety-rated monitored stop, See SF2 on page 1. It is likely, in the future, that "safety-rated monitored stop" will not be called a form of collaborative operation.

### Collaborative Operation 2011 edition, clause 5.10.3

Technique	Explanation	UR e-Series
Hand-guiding	<p>This is essentially individual and direct personal control while the robot is in automatic mode. Hand guiding equipment shall be located close to the end-effector and shall have:</p> <ul style="list-style-type: none"> <li>• an Emergency Stop pushbutton</li> <li>• a 3-position enabling device</li> <li>• a safety-rated monitored stop function</li> <li>• a settable safety-rated monitored speed function</li> </ul>	UR robots do not provide hand-guiding for collaborative operation. Hand-guided teach (free drive) is provided with UR robots but this is for programming in manual mode and not for collaborative operation in automatic mode.

**Collaborative Operation 2011 edition, clause 5.10.4**

Technique	Explanation	UR e-Series
Speed and separation monitoring (SSM) safety functions	<p>SSM is the robot maintaining a separation distance from any operator (human). This is done by monitoring of the distance between the robot system and intrusions to ensure that the MINIMUM PROTECTIVE DISTANCE is assured. Usually, this is accomplished using Sensitive Protective Equipment (SPE), where typically a safety laser scanner detects intrusion(s) towards the robot system.</p> <p>This SPE causes:</p> <ol style="list-style-type: none"> <li>dynamic changing of the parameters for the limiting safety functions; or</li> <li>a safety-rated monitored stop condition.</li> </ol> <p>Upon detection of the intrusion exiting the protective device's detection zone, the robot is permitted to:</p> <ol style="list-style-type: none"> <li>resume the "higher" normal safety function limits in the case of 1) above</li> <li>resume operation in the case of 2) above</li> </ol> <p>In the case of 2) 2), restarting operation after a safety -rated monitored stop, see ISO 10218-2 and ISO/TS 15066 for requirements.</p>	<p>To facilitate SSM, UR robots have the capability of switching between two sets of parameters for safety functions with configurable limits (normal and reduced). Normal operation can be when no intrusion is detected. It can also be caused by safety planes/ safety boundaries. Multiple safety zones can be readily used with UR robots. For example, one safety zone can be used for "reduced settings" and another zone boundary is used as a safeguard stop input to the UR robot. Reduced limits can also include a reduced setting for the stop time and stop distance limits - to reduce the work area and floorspace.</p>

**Collaborative Operation 2011 edition, clause 5.10.5**

Technique	Explanation	UR e-Series
Power and force limiting (PFL) by inherent design or control	<p>How to accomplish PFL is left to the robot manufacturer. The robot design and/or safety functions will limit the energy transfer from the robot to a person. If any parameter limit is exceeded, a robot stop happens. PFL applications require considering the ROBOT APPLICATION (including the end-effector and workpiece(s), so that any contact will not cause injury. The study performed evaluated pressures to the ONSET of pain, not injury. See Annex A. See ISO/TR 20218-1 End-effectors.</p>	<p>UR robots are power and force limiting robots specifically designed to enable collaborative applications where the robot could contact a person and cause no injury. UR robots have safety functions that can be used to limit motion, speed, momentum, force, power and more of the robot. These safety functions are used in the robot application to thereby lessen pressures and forces caused by the end-effector and workpiece(s).</p>

Copyright © 2009-2025 by Universal Robots A/S. All rights reserved.



Software Name: PolyScope 5  
Software Version: 5.25  
Document Version: 10.16.265

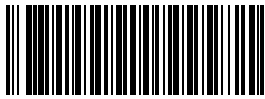

733-429-00



733-429-00