

Thermo Scientific Sorvall MTX 150

for Micro-ultracentrifuges

Instruction Manual

46982-c • 12 / 2021

WEEE Conformity

This product is subject to the regulations of the EU Waste Electrical & Electronic Equipment (WEEE) Directive 2012/19/EU. It is marked by the following symbol:



Contents

Chapter 1	Description.....	1-1
	External view of micro-ultracentrifuge	1-2
	Structure.....	1-2
	Touchscreen	1-2
	Rotor chamber.....	1-6
	Safety devices	1-6
Chapter 2	Operation.....	2-1
	Run preparation.....	2-3
	Starting up this machine	2-3
	Preparing tubes/bottles and rotors.....	2-3
	Applicable rotors.....	2-4
	Basic operation	2-5
	Setting run conditions	2-5
	Operational procedure.....	2-10
	Acceleration rate and deceleration rate	2-14
	How to use the option function.....	2-15
	Programmed operation	2-16
	Step-mode operation.....	2-30
	Displaying and setting RCF.....	2-38
	Selecting the rotor.....	2-39
	Displaying and setting RCF.....	2-41
	User login	2-44
	Features of the MENU screen.....	2-46
	Displaying the Run History and loading the information about run parameters	2-47
	Rotor Catalog.....	2-48
	Rotor Management.....	2-49
	RTC (real-time control) operation.....	2-54
	Customizing the settings.....	2-58
	Administrator (Admin) functions	2-62
	Emergency recovery from power failure	2-70
Chapter 3	Maintenance.....	3-1
	Rotor chamber.....	3-3
	Drive shaft (Spindle).....	3-3
	Cabinet.....	3-3
	Chamber door seal.....	3-3
	Removing the door seal O-ring.....	3-4
	Vacuum pump.....	3-4

	Others	3-4
Chapter 4	Troubleshooting	4-1
	Alarm indicators	4-2
	User-corrected problem	4-4
Chapter 5	Installation	5-1
Chapter 6	Specifications.....	6-1
Chapter 7	Supply list.....	7-1
Appendix A	Chemical Compatibility Chart	A-1
Appendix B	Warranty	B-1
Appendix C	Contact Information	C-1

Preface

General description

The Thermo Scientific Sorvall MTX 150 micro-ultracentrifuge is designed to separate liquid-suspended materials having different densities and particle size.

The Sorvall® MTX 150 is a product that delivers user-friendliness and reliability based on our many years of experience in developing centrifuges. This micro-ultracentrifuge offers many features that we are confident of satisfying your requirements. These features include the following.

1. The maximum speed (g-force) is 150,000 rpm (1,048,680 x g).
2. Small and compact tabletop type for use as a personal micro-ultracentrifuge.
3. The touchscreen with easy-to-see color liquid crystal screen.
4. The displayed language can be switched between Japanese and English.
5. Various alarm indicators can notify users of the causes and necessary actions of the troubles. It can make troubleshooting easier and quicker.
6. Rotors are automatically secured to the drive shaft in the rotor chamber eliminating the need for push buttons and tools.
7. Samples can be balanced visually (see “Preparing tubes/bottles and rotors” on page 2-3).
8. This product operates very quietly, and is thus well suited for personal use on the lab bench.
9. A CFC-free thermomodule cooling system is employed featuring a powerful cooling capacity. (Samples can be kept at 0°C at maximum speed when the ambient temperature is 30°C.)
10. The real-time control (RTC) feature enables setting a start time or a finish time, thus letting you run your machine at a desired date and time.
11. Either Rotations Per Minute (RPM) or Relative Centrifugal Force (RCF_{max} and RCF_{avg}) can be displayed and set.
12. Twenty varieties of nine stepped modes can be programmed for a wide range of applications such as step running.
13. In addition to a door lock and an imbalance detector, two independent microprocessors are incorporated for overspeed detection (a dual CPU overspeed prevention mechanism) for even greater safety.

Safety notices

Safety reminders

Carefully read and fully understand the following safety instructions.

- Operate your instrument according to the instruction manual.
- Be sure to observe all safety precautions in the instruction manual and safety instructions on your instrument. If neglected, personal injury and/or instrument damage can be caused.
- If the equipment is used in a manner not specified by the manufacturer, the protection provided by the equipment may be impaired.
- The safety reminders are indicated as shown below. The signal words “DANGER”, “WARNING” and “CAUTION” are indicated together with the hazard alert symbols in this manual.



DANGER This note indicates an imminently hazardous situation, which if not strictly observed, could result in personal severe injury or possible death.



WARNING This note indicates a potentially hazardous situation, which if not strictly observed, could result in personal severe injury or possible death.



CAUTION This note indicates a potentially hazardous situation, which if not strictly observed, could result in personal injury or severe damage to the instrument.

This hazard alert symbol indicated together with a signal word is a reminder to emphasize important safety instructions.

Note indicates a note which has no direct bearing on personal safety.

- Do not perform any operation not specified in the instruction manual. If any problem is found on your instrument, contact a Thermo Fisher Scientific authorized sales/service representative.
- Although the safety precautions in the instruction manual and safety instructions on your instrument have been fully considered, an unexpected situation may arise. Observe the instructions in the instruction manual and always be careful when operating this instrument.

Mechanical Safety



WARNING

- Do not open the door while the rotor is spinning.
- Do not attempt to slow or stop the spinning rotor by hand.
- Do not incline or move the instrument while the rotor is spinning. Do not place any object on the instrument or lean on the instrument.
- Do not attempt to unlock the door forcefully while the rotor is spinning.
- For operator safety, maintain a 30-cm “clearance envelope” around the instrument while the rotor is spinning. Do not store dangerous substances capable of developing flammable or explosive vapors on or near the micro-ultracentrifuge.
- Repairs, disassembly, and other modifications to the micro-ultracentrifuge are strictly prohibited unless performed by a Thermo Fisher Scientific authorized sales/service representative.
- Do not use the other’s manufacturer’s rotor without Thermo Fisher Scientific’s permission.
- Always use a quick-setting rotor for this micro-ultracentrifuge. The screw-type rotors are inapplicable.
- Check the chemical resistance chart attached to the rotor, and do not use any sample inapplicable to the rotor (including the buckets). Using such a sample could corrode the rotor (including the buckets).
- Do not exceed the maximum rated speed of the rotor or buckets in use.
- Do not use corroded, scratched or cracked rotor and buckets. Check that the rotor and buckets are free of such abnormalities before operation.
- When using a swing rotor, check that the buckets are properly engaged with the rotor pins before operation. Wrong setting can cause severe damage to the instrument. Make sure that all the rotor buckets are of the same type.
- If abnormal sound or vibration occurs, stop the operation immediately and contact a Thermo Fisher Scientific authorized sales/service representative.

CAUTION

- Position the micro-ultracentrifuge on a level surface, such as a table or laboratory bench that can support the weight of the micro-ultracentrifuge and resist vibration.
- Be sure to remove the rotor from the rotor chamber when micro-ultracentrifuge is not used for a long time or when the machine is moved. Otherwise the drive shaft (crown) may be damaged.
- Before using a rotor, be sure to read through the rotor instruction manual.
- Check the chemical resistance chart attached to the rotor, and do not use any sample inapplicable to the tubes, tube caps, bottles, or bottle caps, etc. Using such a sample could corrode or deteriorate such parts.
- Use the rotor tubes and bottles within their actual capacities.
- Mount the rotor onto the drive shaft gently and properly.
- Do not drop the rotor or apply excessive force to the drive shaft to avoid damage to the drive shaft.
- Maximum rotor speed depends on the tubes or adapters to be used. Follow the instructions on the rotor instruction manual.
- This micro-ultracentrifuge might convey vibration to a table while the rotor is rotating. If a measuring device is positioned on a table and near this micro-ultracentrifuge, use a measuring device carefully.
- Approximately even quantities of sample in the tubes are sufficient for balancing, and extremely different sample quantities must be avoided (Refer to “[Preparing tubes/bottles and rotors](#)” on [page 2-3](#) for the sample balancing).
- Clean the inside of the drive hole (crown hole) of the rotor and the surface of the drive shaft (crown) of the micro-ultracentrifuge once a month.
- When storing the rotors on a shelf, take appropriate safety measures in areas prone to earthquakes
- Do not pour any solution such as water, detergent, or disinfectant directly into the rotor chamber and be careful not to spill the sample into the rotor chamber. If you do so, the bearings of the drive unit might corrode or deteriorate and it might cause vacuum failure.
- Do not operate the display panel (Touchscreen) using a ball-point pen.



Safety during installation and maintenance

**DANGER**

- Before removing the cover, top deck, or other component for maintenance, always turn off the POWER switch of the instrument, unplug the power cord from the wall outlet, and wait at least three minutes to avoid the risk of electrical shock.

**WARNING**

- For maintenance and repairing of the rotors, tubes, etc., see the rotors and tubes instruction manual.
- After installation and before any test-run, this micro-ultracentrifuge always needs the internal check by a Thermo Fisher Scientific authorized sales/service representative.
- Repairs, disassembly, and other modifications to the micro-ultracentrifuge are strictly prohibited unless performed by a Thermo Fisher Scientific authorized sales/service representative.

**CAUTION**

- If the micro-ultracentrifuge is exposed to ultraviolet rays for a long time, the color of the covers may be changed or the coating may be peeled off. After use, cover the micro-ultracentrifuge with a cloth to protect it from direct exposure.

Electrical Safety**WARNING**

- Your micro-ultracentrifuge must be grounded properly to avoid electrical shock hazards.

**CAUTION**

- Do not place containers holding liquid in the rotor chamber or on or near the instrument. If they spill, liquid may get into the instrument and damage electrical components.
- If the machine will not be used for a long time, turn off the main circuit breaker.

Safety against Risk of Fire**WARNING**

- This micro-ultracentrifuge is not explosion-proof. Never use explosive or flammable samples or materials that chemically react vigorously. Do not centrifuge such materials in this instrument or handle or store them near the instrument.

Chemical and Biological Safety**WARNING**

- Take all necessary safety measures before using samples that are toxic or radioactive, or blood samples that are pathogenic or infectious. You use such samples at your own responsibility.
- Take all necessary safety measures when Risk Group II materials (as identified in the World Health Organization “Laboratory Biosafety Manual”) are handled, and that more than one level of protection shall be provided in the case of materials of a higher group.
- If the micro-ultracentrifuge, rotor, or an accessory is contaminated by samples that toxic or radioactive, or blood samples that pathogenic or infectious, be sure to decontaminate the item according to good laboratory procedures and methods.
- If there is a possibility that the micro-ultracentrifuge, rotor, or an accessory is contaminated by samples that might impair human health (for example, samples that are toxic or radioactive, or blood samples that are pathogenic or infectious), it is your responsibility to sterilize or decontaminate the micro-ultracentrifuge, rotor, or the accessory properly before requesting repairs from a Thermo Fisher Scientific authorized sales/service representative.
- It is your responsibility to sterilize and/or decontaminate the micro-ultracentrifuge, rotor, or parts properly before returning them to a Thermo Fisher Scientific authorized sales/service representative.

Notice for an Earthquake

Depending on the magnitude, an earthquake might damage micro-ultracentrifuge. If you observe some abnormality, stop using the micro-ultracentrifuge immediately and ask for inspection by the Thermo Fisher Scientific service representative.

Description

Contents

- “External view of micro-ultracentrifuge” on page 1-2
- “Structure” on page 1-2

External view of micro-ultracentrifuge

The Sorvall MTX 150 micro-ultracentrifuge is tabletop type and requires a small amount of space.

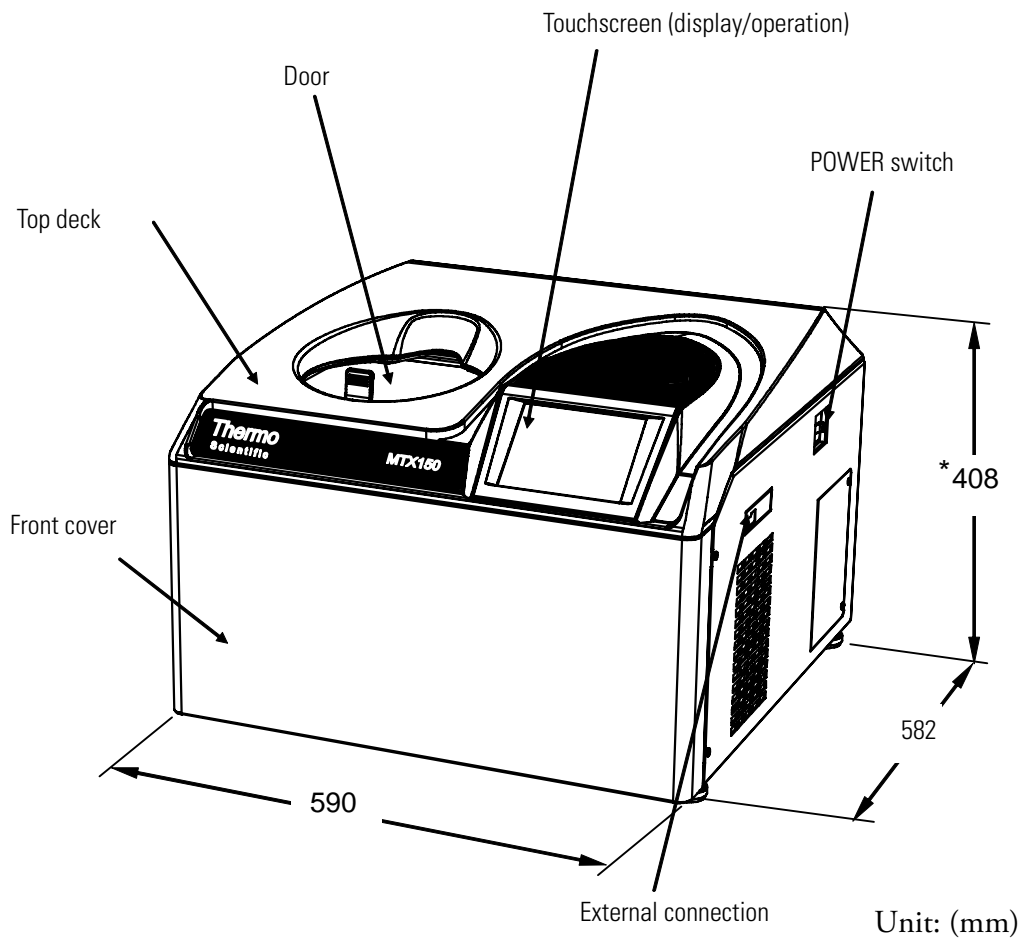

Figure 1-1. External view of Sorvall MTX 150 micro-ultracentrifuge

Note * This size is the minimum size and depends on the installation conditions

Structure

Touchscreen

The touchscreen with color liquid crystal screen is incorporated in the Sorvall MTX 150 micro-ultracentrifuge. You can set the run conditions, perform the operation, and display Run History, Programmed Run, and User Customizations Screens by pressing the screen. Fig. 1-2 shows the touchscreen.

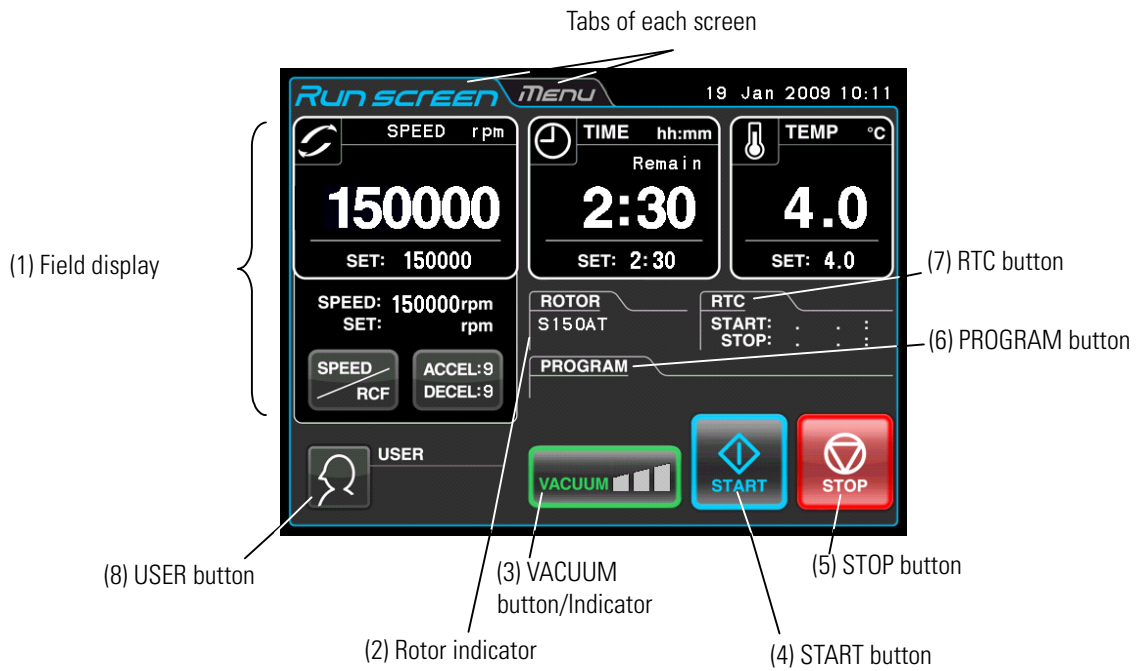

Display at the normal operation

The following screen appears by pressing the SPEED, TIME, or TEMP button.

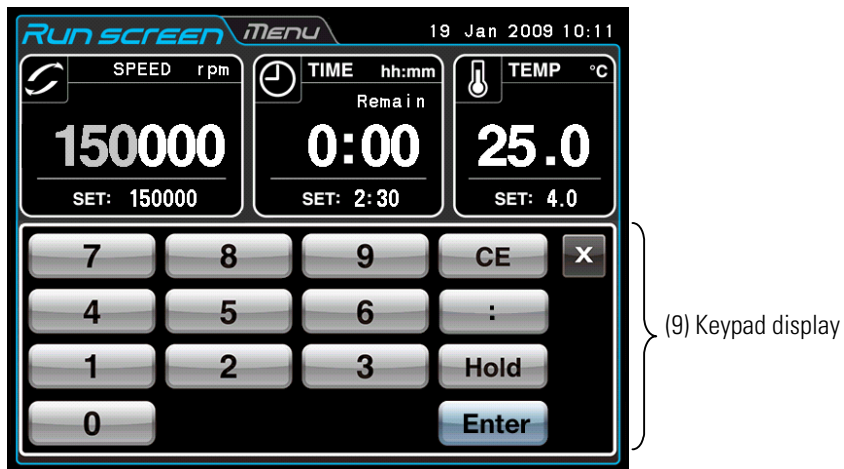

Display when setting the run conditions such as the speed etc.)

Figure 1-2. Touchscreen

Table 1-1. Functions of the Run screen











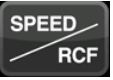

No.	Name and Symbol	Functions and Actions
(1)	<p>Field display</p> <p>SPEED column (RCF column)</p>  <p>TIME column</p>  <p>TEMP column</p>  <p> button</p> <p> button</p>	<p>Display various fields.</p> <p>The SPEED (RCF), TIME, and TEMP fields give the current status indicator in the top row and the setting indicator in the bottom row. (For setting, see “Setting run conditions” on page 2-5.)</p> <ul style="list-style-type: none"> • SPEED (Speed indicator) (Top row) Displays speeds in increments of 10 rpm at lower than 5,000 rpm, and in steps of 100 rpm at 5,000 rpm or more. (Bottom row) Sets speeds from 5,000 to maximum speed in increments of 1,000 rpm. The lower three digits (one, ten, and one-hundred positions) display zeros. Maximum speed: 150,000 rpm For RCF, see “Displaying and setting RCF” on page 2-41. • TIME (running time indicator) (Top row) Displays the remaining operation time. If the running time is set to HOLD, this field displays time elapsed. (Bottom row) Specifies a setting in the range from 1 minute to 99 hours 59 minutes in steps of minutes and hours. • TEMP (temperature indicator) When the pressure in the rotor chamber equals the atmospheric pressure, the temperature of the inside of the rotor chamber is kept at 25 °C to prevent condensation. (Top row) Displays in steps of 0.1 °C. (Bottom row) Sets a setting in the range from 0 °C to 40 °C in increments of 1 °C <p>The  column is shifted from SPEED (RCF) column to RCF (SPEED) column by pressing this button.</p> <p>The Acceleration rate and Deceleration rate are set by pressing this button.</p> <ul style="list-style-type: none"> • ACCEL (acceleration mode indicator) Displays acceleration modes 1 through 9. • DECEL (deceleration mode indicator) Displays deceleration modes 1 through 9, along with free coast (F).
(2)	<p>Rotor indicator</p> 	<p>ROTOR CATALOG is displayed by pressing this button and you can select the desired rotor.</p>
(3)	<p>VACUUM button</p> 	<ul style="list-style-type: none"> • Press this button to turn the vacuum pump on or off. When the vacuum pump is turned off, the pressure in the rotor chamber will change to equal the atmospheric pressure. (While the rotor is rotating, you can not turn off the vacuum pump.) • Temperature control starts as soon as the vacuum pump is turned on. Displays the following four stages according to the vacuum of the rotor chamber. <p>(1)  Atmospheric state. The vacuum pump is not activated.</p> <p>(2)  Low vacuum. The rotor waits at 5,000 rpm until the vacuum reaches an intermediate level.</p> <p>(3)  Intermediate vacuum.</p> <p>(4)  High vacuum.</p> <div data-bbox="1066 1783 1474 1912" style="border: 1px solid black; padding: 5px;"> <p>NOTE: If the sample is sensitive to a temperature rise, do not press the START button until the chamber is at a high vacuum level</p> </div>
(4)	<p> button</p>	<p>Starts rotor rotation. If VACUUM is off, pressing this button activates the vacuum pump and starts temperature control.</p>

Table 1-1. Functions of the Run screen





No.	Name and Symbol	Functions and Actions
(5)	 button	Stops rotor rotation.
(6)	 button	Displays the program No. if program operation has been selected. Press this button to specify program settings (see “ Programmed operation ” on page 2-16).
(7)	 button	Displays the start time or finish time for centrifugation. Press this button to set a start time or finish time (see “ RTC (real-time control) operation ” on page 1-1).
(8)	 button	Displays the user name (see “ Administrator (Admin) functions ” on page 2-62).

Table 1-2. Functions of the keypad display

No.	Name and Symbol	Functions and Actions
(9)	Keypad display  When entering the deceleration rate, FREE is displayed in the position of Hold.	Use the keypad display to enter numeric values for run parameters. : When entering a time: Switches from hours to minutes Hold When entering the operation time: Sets continuous running. Free When entering deceleration conditions: Sets free coasting. CE Press this to cancel input (for example, if you enter the wrong number or the wrong value for a run parameter) Enter Press this to save the entered setting. X Press this to close the keypad display.

Table 1-3. External connection

No.	Name and Symbol	Functions and Actions
(10)	USB (host side) 	Use the USB connection to output the operation history of the micro-ultracentrifuge to USB memory.
(11)	USB (device side) 	Use for connecting optional items.

Rotor chamber

The structure of the rotor chamber (vacuum chamber) is shown in Fig. 1-3.

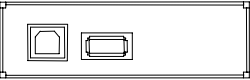
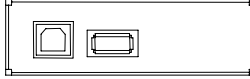
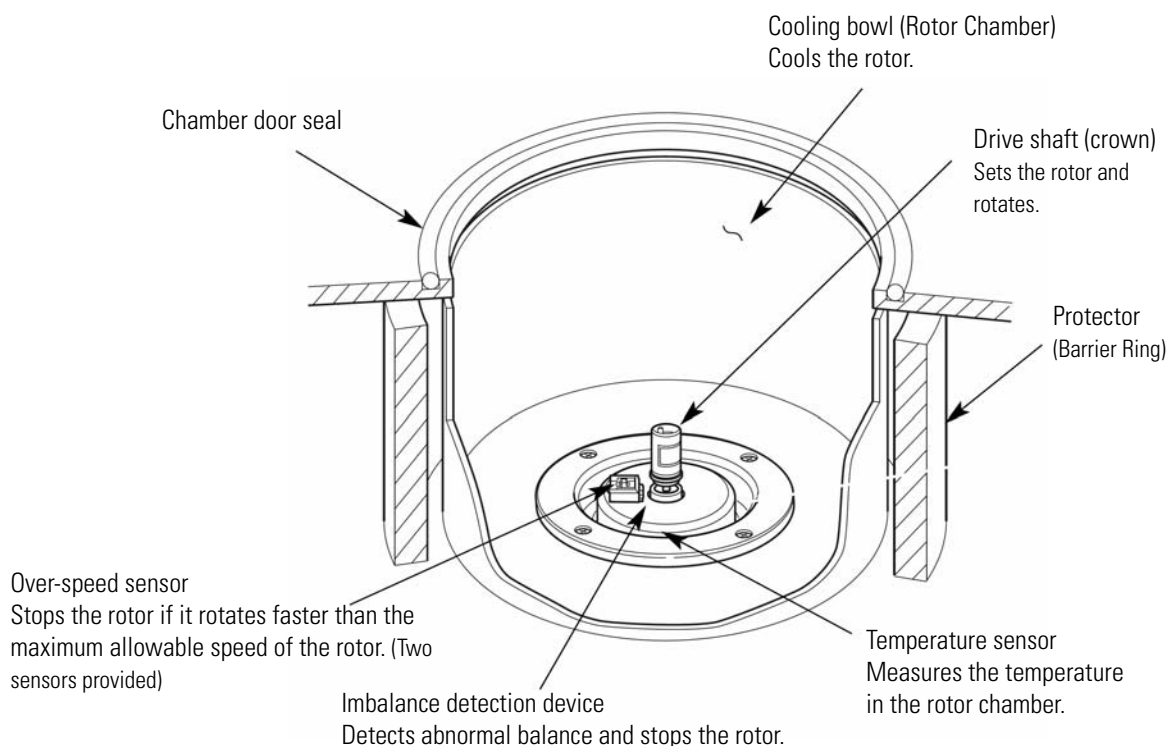

Figure 1-3. Rotor Chamber

Safety devices

1. Protection of rotor chamber

Should the rotor fail at high speed (or comes off the drive shaft), the safety of the operator is ensured by the thick armored barrier ring enclosing the cooling bowl (Fig. 1-3).

2. Imbalance detector

If during operation the vibration of the rotor becomes excessive due to serious imbalance or improper bucket setting, the imbalance detector detects the situation and decelerates the rotor immediately. However, the micro-ultracentrifuge is designed to tolerate imbalance associated with visual balancing - it is equipped with an imbalance tolerant drive. (For more information on the balancing of rotors, see [“Preparing tubes/bottles and rotors”](#) on [page 2-3.](#))

3. Door lock system

The chamber door automatically locks for safety while the rotor is spinning. When the power supply is off, the door remains locked. The door can only be opened and closed when the rotor is at rest and the rotor chamber vacuum has been vented. To open the door in the event of a power failure, see [“Emergency recovery from power failure”](#) on [page 2-70.](#)

4. Overspeed detector

This micro-ultracentrifuge incorporates a detector designed to prevent the rotor from spinning at a speed exceeding the maximum allowable speed.

Two independent microprocessors (CPUs) check the rotor for overspeed, thus increasing safety

further (dual CPU overspeed preventive mechanism).

The first CPU detects overspeed and performs control and display. Should the rotor be set to a speed exceeding the permissible speed, this CPU detects an alarm message of "SPEED" from the low speed range (about 2,000 rpm), and stops the rotor.









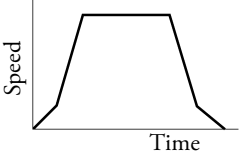

(But this second CPU does not display an alarm message, because it is not connected to the display-performing CPU. Should the alarm device be activated, pressing START button will not run the instrument. Turn off the POWER switch, wait for several minutes, turn the POWER switch on again, then pressing START button.)

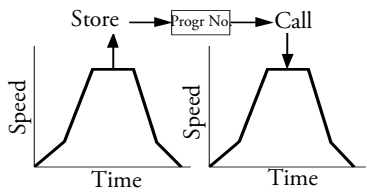
Operation

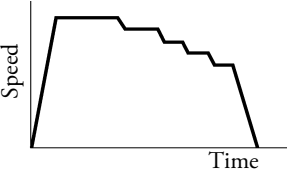
Contents

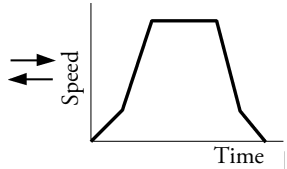
- “Run preparation” on page 2-3
- “Basic operation” on page 2-5
- “How to use the option function” on page 2-15
- “Features of the MENU screen” on page 2-46
- “Emergency recovery from power failure” on page 2-70

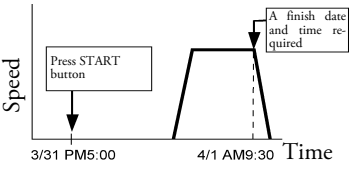
The Sorvall MTX 150 micro-ultracentrifuge is capable of operation in more than one mode to meet a wide range of applications. The outline of each available mode is given below:

Brief Description		Reference
Normal operation		 "Basic operation" on page 2-5
Other features	Programmed operation You can store set run conditions in memory for later use in repeated operation. 	 "Programmed operation" on page 2-16
	Step-mode operation More than one normal operation can be combined into a sequence of operations or step for successive centrifugation. 	 "Step-mode operation" on page 2-30
	RCF (centrifugal force) value display setting This feature calculates centrifugal force (RCF) values from set speed. It can also calculate reversely, i.e., finding speed from such values. 	 "Displaying and setting RCF" on page 2-41
	Spin-down operation Spin-down operation is useful to remove the adhered samples on the interior walls of the tubes.	 "Spin-down operation" on page 2-53
	RTC (real-time control) operation Run starts or completes at a required date and time. 	 "RTC (real-time control) operation" on page 2-1

Run preparation



WARNING

1. This micro-ultracentrifuge is not explosion-proof. Never use explosive or flammable samples, or materials that chemically react vigorously. Do not centrifuge such materials in this instrument nor handle or store them near the instrument.
2. Take all necessary safety measures before using samples that are toxic or radioactive, or blood samples that are pathogenic or infectious. You use such samples at your own responsibility.



CAUTION Do not place containers holding liquid in the rotor chamber, on the micro-ultracentrifuge, or near the micro-ultracentrifuge. If split, liquid might get into the instrument and damage electrical and mechanical components.

Starting up this machine

Before setting run conditions, display the Run screen (Screen for setting run conditions)

(1) Displaying the Run screen (Screen for setting run conditions)

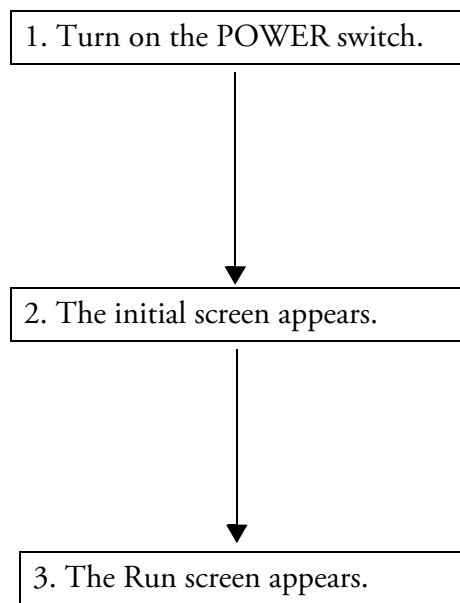

Thermo
SCIENTIFIC

SORVALL
MTX 150
Micro-Ultracentrifuge

Initial screen



Figure 2-1. Initial screen and Run screen

Preparing tubes/bottles and rotors

The Sorvall MTX 150 micro-ultracentrifuge allows you to balance, by eye, tubes or bottles containing a sample solution and then centrifuge them. Make sure that the approximate difference between meniscus levels of sample solution in tubes or bottles is within 5 mm (See Fig. 2-2).

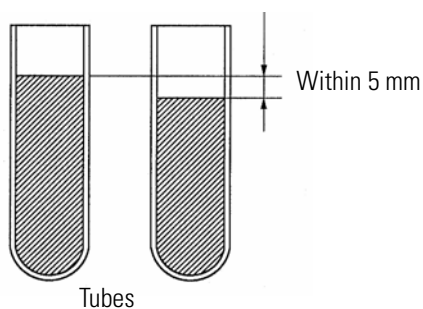

For an S140AT rotor, an S100AT5 rotor, and an S50A rotor, set the approximate meniscus level difference to within 3 mm, and for an S110AT rotor and an S80AT3 rotor, set it to within 4 mm.

Figure 2-2. Balancing tubes/bottles containing a sample solution



CAUTION Do not run the micro-ultracentrifuge in an extremely imbalance condition. This might cause a mechanical failure. When balancing tubes or bottles by eye, alarm message “IMBALANCE” might appear. Balance tubes or bottles more accurately again if alarm message “IMBALANCE” appears.

Depending on the type of tube or rotor combined with this machine, an excessively low liquid level may limit the speed or crush the tube.

- When sealed tubes are used, fill the tubes with liquid to the full level.



CAUTION

1. Before using a rotor, read the rotor instruction manual carefully.
2. Do not use any corroded, scratched, cracked, or otherwise damaged rotor or bucket. Before operation, always check if there is no corrosion and damage on the rotor surface.
3. Before running a swing rotor, make sure that each bucket is hooked on a pin securely. Poor setting might seriously damage the instrument. Even though all of them are not used, make sure to install all buckets at any time. Make sure that all the rotor buckets are of the same type.
4. Some tubes and adapters are inapplicable at the maximum speed of the rotor. Refer to the rotor instruction manual carefully.
5. The S58A rotor, S55A rotor, and S50A rotor can handle sample whose mean density is 1.2 g/ml or less. Do not rotate this rotor at its maximum speed when using a sample whose mean density is over 1.2 g/ml. Refer to the rotor instruction manual (Part No. PN 45735) for how to limit the maximum speed when using a sample whose mean density is over 1.2 g/ml.

Applicable rotors

For the Sorvall MTX 150 micro-ultracentrifuge you can only use automatic securing rotors shown below. These rotors can be installed by merely placing it on the drive shaft in the rotor chamber. Screw-type rotors, also shown below, are inapplicable to the Sorvall MTX 150 micro-ultracentrifuge.

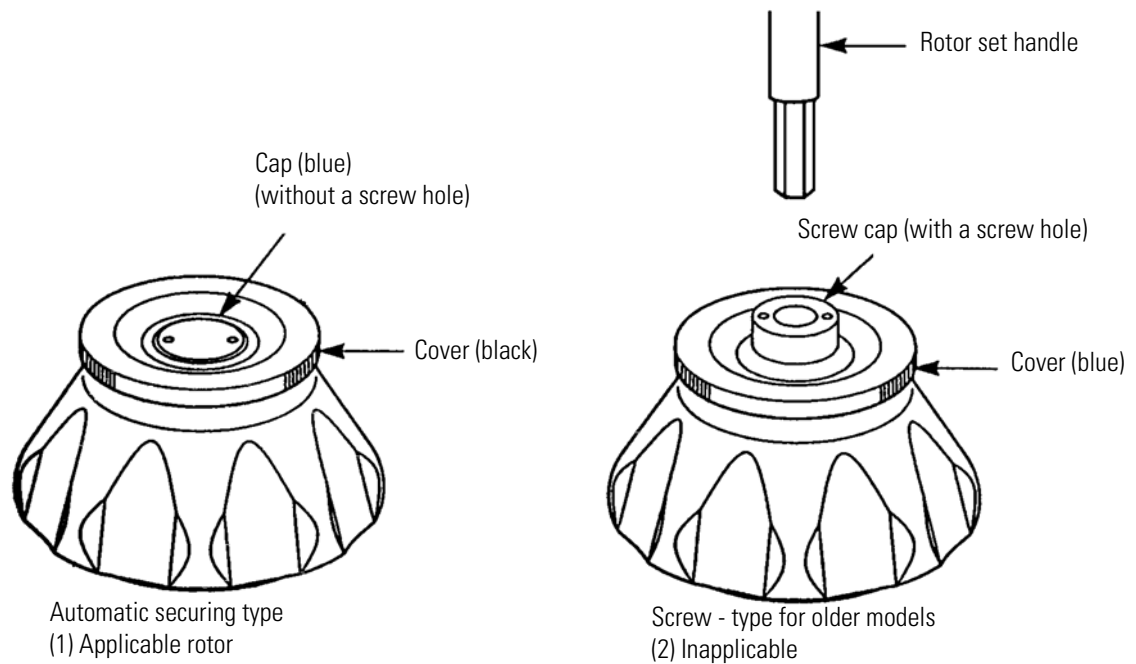
**CAUTION**

1. Always use an automatic securing rotor for this micro-ultracentrifuge. The screw-type rotors are inapplicable.

Automatic securing rotors are not applicable in older models (RC-M100, RC-M120, and RC-M120EX Centrifuges).

2. The rotor must be gently placed on the drive spindle to avoid damaging the drive shaft.
3. Use only rotors approved for use in the Sorvall MTX 150 (see list of approved rotors in “Specifications” on page 6-1).

**Basic operation**

WARNING Do not incline or move the instrument while the rotor is spinning. Do not place any object on the instrument or lean on the instrument.

**CAUTION**

1. Do not press the touchscreen with a sharp-pointed object such as a ballpoint pen.
2. If abnormal sound is heard during the operation, stop the operation immediately and contact a Thermo Fisher Scientific authorized sales/service representative.

Setting run conditions

This section will first describe the screen for basic operation (the Run screen). For the display at the normal operation and the display when setting the run conditions, refer to “Touchscreen” on page 1-2.

[Run Screen]

The screen for displaying run conditions and operational status is called the Run screen. Speed, time, and temperature are displayed in two rows: the top row displays the current actual run conditions, while the bottom row displays the set run conditions. The acceleration (ACCEL) and the deceleration (DECEL) fields display set conditions.

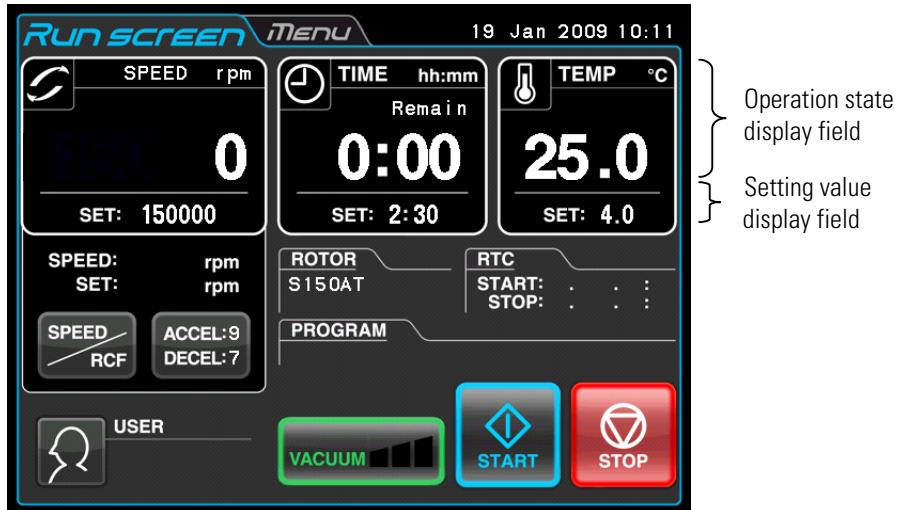
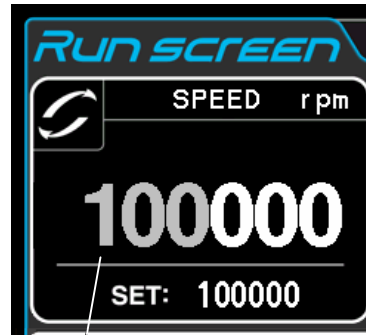

Figure 2-3. Run screen

[Display and operations when entering the run parameters]

The keypad display appears by pressing the SPEED column, TIME column,  button.

(1) Press the column of the desired item to turn the first digit blue.



Color of the first digit: Blue

(2) Enter the desired numeric value with the keypad display.
(e.g.) SPEED:150,000rpm
Press the 1, 5, 0.

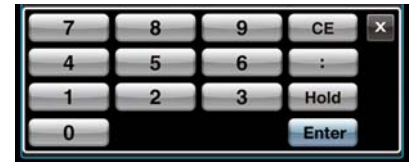

[Keypad display]

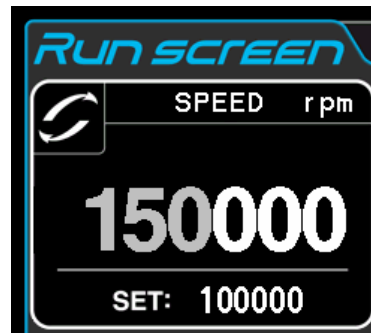

(3) If you do not want to change any other setting, press the ENTER button on the keypad display. If you do want to change other setting, press the column of the desired item, and the pressed column will become the input wait state. The new setting is displayed on the setting value display field.

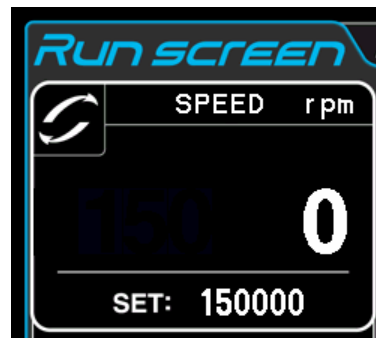

Setting value display field

Figure 2-4. Setting value display field









The next page describes how to set run condition by citing some examples.



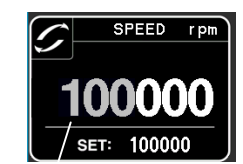

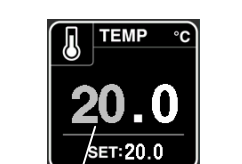
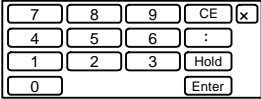
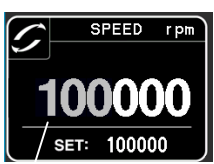
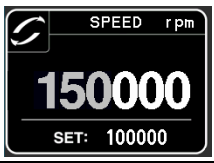

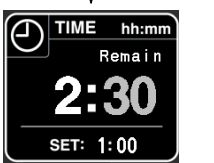
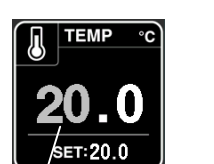
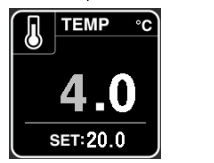
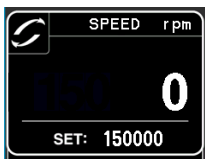

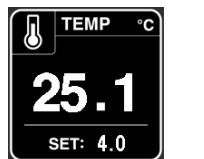
Note

1. If you enter the wrong value, press the CE button and then enter the correct value. If you have pressed the Enter button, repeat step (1) of the previous page, and then enter the correct value.
2. When setting the two or more of three run conditions (SPEED, TIME, and TEMP), you do not have to press the Enter button after each setting. You can store the setting by pressing the desired item.
3. If the system is running in (HOLD) and you want to set it to shut down at a future time, enter a new time setting while the instrument is in operation; enter the sum of the time elapsed plus the time remaining. If, for example, this machine has run continuously for five hours and you want to stop it one and a half hours later, press the TIME column, then enter

- **How to set speed, running time, temperature, and other parameters**

Here are some examples and descriptions:







Setting item		RPM (SPEED)	Running time (TIME)	Temperature (TEMP)	
Typical setting		150,000 rpm	2 hours 30 minutes	4°C	
Operation procedure	1	Press the SPEED, TIME, or TEMP column to show the keypad display.			
	2	The last entered value is displayed on each column. Press the column of the desired item again if the color of the first digit is white. Go to procedure 3 if the color of the first digit is blue.			
	3	Enter the desired numeric value with the keypad display.  Entered numbers are moved to the left every time a new number is entered.	Color: Blue  ↓ 1 5 0 The last three digits are fixed. ↓ 	Color: Blue  ↓ 2 : 3 0 Press the : button to turn the number of minutes blue. For a continuous run, press the Hold button. ↓ 	Color: Blue  ↓ 4 ↓ 
	4	Make a check, then if you want to change other setting, press the column of the desired item. If you do not want to change any other setting, press the ENTER button. Use the CE button to cancel input.	Set it to 150,000 rpm. 	Set it to 2: 30. (2 hours 30 minutes) 	Set it to 4°C. 
Setting range and units		Can be set to any value in the range from 5,000 rpm to maximum speed in increments of 1,000 rpm.	Can be set to any value up to 99 hours 59 minutes in increments of 1 minute.	Can be set to any value in the range from 0 to 40 °C in increments of 1 °C.	

Setting item		Acceleration (ACCEL)	Deceleration (DECEL)
Typical setting		9	7
Operation procedure	1	Press the  button to show the keypad display.	
	2	Press the column of the desired item.	
	3	Enter the desired numeric value with the keypad display. 	  
	5	Make a check, then if you want to change other setting, press the column of the desired item. If you do not want to change any other setting, press the ENTER button. Use the CE button to cancel input.	Set it to 9. 
Setting range and units		1-9	1-9 + free coast (FREE)

Operational procedure

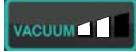
Given below is a description of the operational procedure for a normal run.

Note Before starting up this machine, carefully read the operation manual for your rotor and make sure that you have selected the correct type of tubes and entered the correct amount of sample.

Process	Touch panel operation	Screen display and notice
1	Turn on the POWER switch on this machine.	<ul style="list-style-type: none"> The touchscreen is displayed. The door is unlocked.
2	Install the rotor (the quick setting rotor.)	<ul style="list-style-type: none"> Install the rotor securely on the crown. (It does not have to be screwed into the crown.) Always use a quick setting rotor (see "Applicable rotors" on page 2-4).
3	Set run conditions.	<ul style="list-style-type: none"> See "Setting run conditions" on page 2-5 and set run conditions.
4	Press the VACUUM button. (You can omit this step.) <div style="text-align: center; margin-top: 10px;">  </div> <div style="text-align: center; margin-top: 20px;">  </div> <div style="text-align: right; margin-top: 10px;"> <p>(1) In a low vacuum</p>  (1 indicator) <p>(2) In an intermediate vacuum</p>  (2 indicator) <p>(1) In a high vacuum</p>  (3 indicator) </div>	<ul style="list-style-type: none"> The machine starts evacuating the rotor chamber. Temperature control starts. The degree of vacuum in the rotor chamber is displayed on the vacuum indicator on the VACUUM button. <p>(1) In a low vacuum</p> <p>(2) In an intermediate vacuum</p> <p>(1) In a high vacuum</p> <ul style="list-style-type: none"> If the rotor compartment has moisture or frost on it, it takes a long time to reach an intermediate high vacuum. In that case, wipe it off with a clean, dry cloth or sponge. If the sample is sensitive to a temperature rise, do not press the START button until the chamber is at high vacuum level.
5	Press the START button. <div style="text-align: center; margin-top: 10px;">  </div>	<ul style="list-style-type: none"> The START button blinks and the rotor starts turning. The timer begins operating. (When the actual run timer is activated, the timer begins operating after the speed reaches the set speed.) When the speed reaches the set speed, the START button lights up. This micro-ultracentrifuge waits at 5,000 rpm until an intermediate vacuum is reached.
6	The specified centrifugation time elapses (time-out). Or press the STOP button. <div style="text-align: center; margin-top: 10px;">  </div>	<ul style="list-style-type: none"> The STOP button blinks and the rotor starts decelerating.
7	The rotor stops.	<ul style="list-style-type: none"> The STOP button lights up. The stop signal sounds to indicate that the rotor has stopped.

Process	Touch panel operation	Screen display and notice
8	Press the VACUUM button. 	<ul style="list-style-type: none"> • The vacuum stops, the air leak valve becomes activated, and the rotor chamber reaches atmospheric pressure. • The door unlocks, and is able to be opened and closed.
9	Take out the rotor.	<ul style="list-style-type: none"> • Stop the rotor completely before taking it out.

Note When the rotor chamber is vacuumed insufficiently before starting operation or the ambient temperature is low (10°C or below), the vacuum waiting time at 5,000rpm may become longer. Also, during acceleration up to the set speed, the instrument may become a vacuum waiting state. Therefore, before starting operation, vacuum the rotor chamber sufficiently (approx. 15 minutes) and then press the VACUUM button and check that the displayed vacuum is at a high vacuum level (3 indicator).

Fig. 2-5 summarizes the operational procedure.

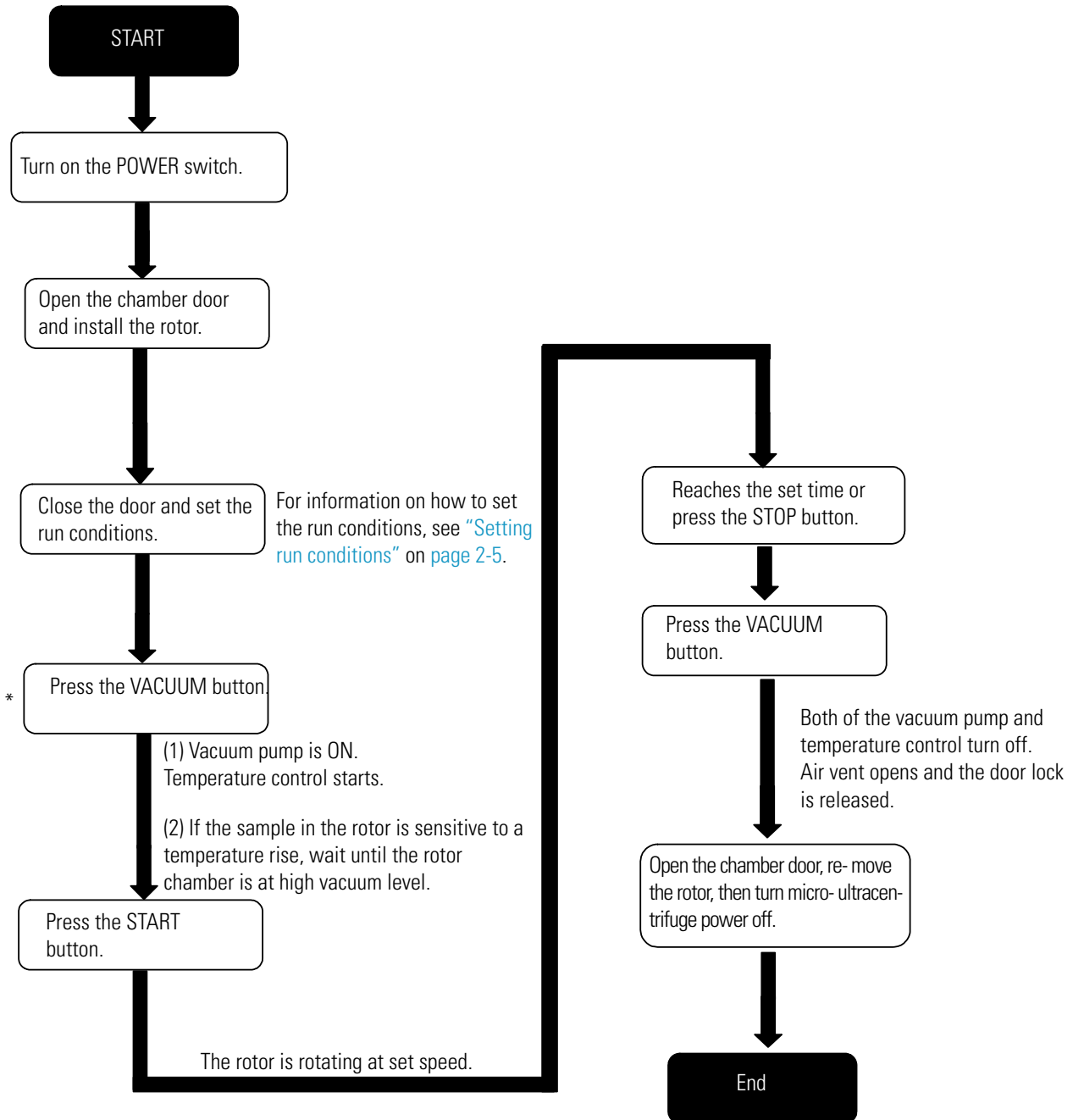

*This step may be omitted, in which case pressing the START button later in the procedure turns on the vacuum pump and the rotor stays at 5,000 rpm to wait for chamber vacuum to reach its intermediate level.

Figure 2-5. Operational procedure

Acceleration rate and deceleration rate

In order to meet various experimental protocols, the acceleration and deceleration rates can be adjusted.

The figure and table below show the relationship between ACCEL/DECEL code numbers selected and resulting approximate acceleration/deceleration times.

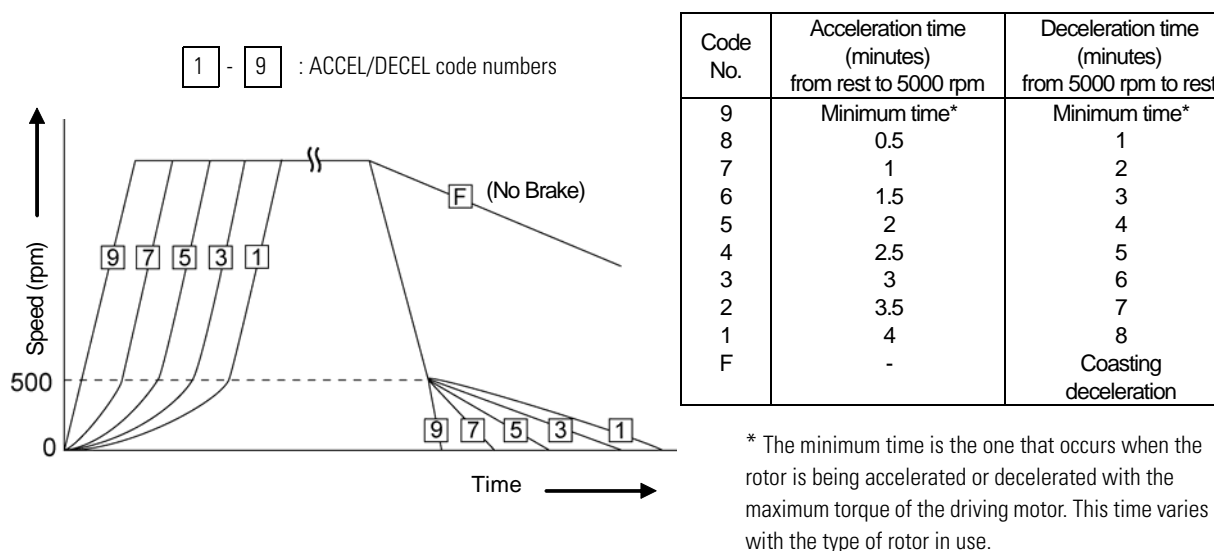

Note The times for acceleration and deceleration may be longer than the values listed above, depending upon the type of rotor in use.

Typical examples of application of acceleration and deceleration rates

Type of centrifugation	Code No.		Characteristic of separation
	ACCEL	DECEL	
Density gradient centrifugation using a vertical rotor	5	7	The sample and gradient in tubes reorient during acceleration and deceleration. Therefore, the sample and gradient can become mixed, especially in wide tubes, if you use rapid acceleration or deceleration.
DNA separation by CsCl isopycnic separation (self-forming gradients)	9	7	You can operate at maximum acceleration because the density gradient is not formed during the run. As for the deceleration, it is better to decelerate slowly to obtain sharp bands.
Pelleting using a fixed angle rotor	9	9	Rapid pelleting of samples is possible (the run time decreases).
Density gradient centrifugation using a swinging bucket rotor	5 to 8	5 to 8	The sample and gradient do not reorient. Therefore, mixing of the layers is less than that in the case of using a vertical rotor. But it is safe not to accelerate or decelerate the rotor by selecting minimum time.

Type of centrifugation	Code No.		Characteristic of separation
	ACCEL	DECEL	
Density gradient centrifugation using a vertical rotor	5	7	The sample and gradient in tubes reorient during acceleration and deceleration. Therefore, the sample and gradient can become mixed, especially in wide tubes, if you use rapid acceleration or deceleration.
DNA separation by CsCl isopycnic separation (self-forming gradients)	9	7	You can operate at maximum acceleration because the density gradient is not formed during the run. As for the deceleration, it is better to decelerate slowly to obtain sharp bands.
Pelleting using a fixed angle rotor	9	9	Rapid pelleting of samples is possible (the run time decreases).
Density gradient centrifugation using a swinging bucket rotor	5 to 8	5 to 8	The sample and gradient do not reorient. Therefore, mixing of the layers is less than that in the case of using a vertical rotor. But it is safe not to accelerate or decelerate the rotor by selecting minimum time.

How to use the option function

This micro-ultracentrifuge incorporates a number of features, such as step-mode and other programmed running, display and setting of centrifugal force, and RTC (real-time control) that can run the micro-ultracentrifuge at a required date and time. Buttons for these features are displayed and specified on the Run screen.

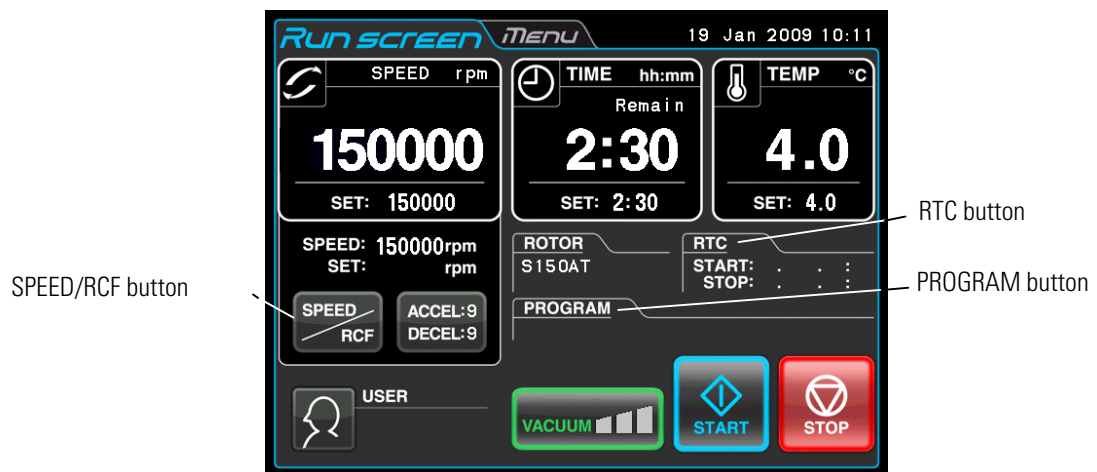

Figure 2-6. Option buttons

PROGRAM button:	Programs, stores, and recalls run conditions. This feature also offers a step-mode operation: a continuous run of multiple run conditions.
SPEED/RCF button:	This feature is used to cause the system to automatically calculate and display an RCF value. It also sets an RCF value and calculates the speed. RCF_{max} indicates the maximum centrifugal force for the maximum radius R_{max} of the rotor which is used. RCF_{avg} indicates the average centrifugal force for the average radius R_{avg} of the rotor which is used.
RTC button:	Sets a start time or a finish time and runs the micro-ultracentrifuge at a desired date and time.

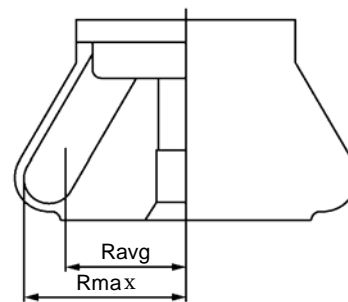

Figure 2-7. Rotor radius

The above features can be used in combination.

Note To perform a combination of PROGRAM and RTC, first set PROGRAM and then set the RTC.
Once RTC is activated, you cannot change the run time. You therefore cannot activate PROGRAM.

Programmed operation

When a centrifugal condition is to be used frequently, entering the same condition every time you want to perform centrifugation is inconvenient.

This micro-ultracentrifuge has a programmed operation feature that stores run conditions. Storing run conditions which you often use allows you to call those conditions however often you may wish, thus saving time in setting. (Even while the POWER switch is OFF, this micro-ultracentrifuge retains the conditions entered.)

This micro-ultracentrifuge incorporates the program areas indicated below. It has twenty memory areas and nine steps in each memory unit.

Running this machine with each memory unit retaining multiple steps will allow you to change the speed, run time, temperature, and others while in operation.

(Step-mode operation)

Memory 1	Step 1	Step 2	Step 9
Memory 2	Step 1	Step 2	Step 9
Memory 3	Step 1	Step 2	Step 9
.
.
.
.
.
Memory 20	Step 1	Step 2	Step 9

Figure 2-8. Program areas

(Basic operation of the programmed operation feature)



Press the PROGRAM button.



Program No. which stores the run parameters is displayed.

If you load the run parameters, into the micro-ultracentrifuge, see the note below.

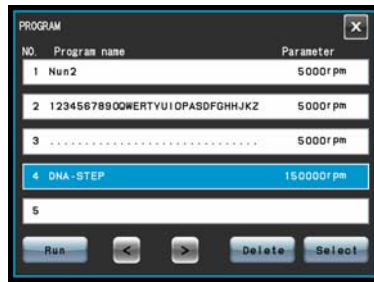

* Press the column of the desired Program No.

Programmed operation possible

If you create, change, or delete a program, see the note below.



Press the Run button to go back to the Run screen. The loaded run parameters are displayed on the Run screen.

- If you create or change a program, Press the Select button.
- If you delete a program, Press the Delete button.

Note You cannot create, change, or delete a program while in running. Perform these operations while not in running. However, you can search the PROGRAM screen every time.
 * If you do not know Program No. of the program which you need, see “Programmed operation” on page 2-16 (2) (b).

1. Programming procedure for run conditions (creating or changing)

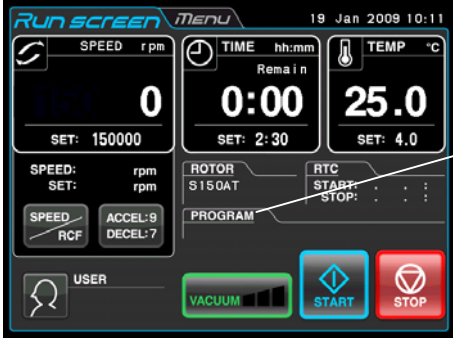
Shown below is the procedure for storing (creating) or changing a run condition.
 If you want to store the user name in the program, you have to load the user name into the micro-ultracentrifuge in advance (see “Administrator (Admin) functions” on page 2-62 (1)).

Process	Touch panel operation	Screen display and notice
1	Press the PROGRAM button on the Run screen.	<div style="display: flex; flex-direction: column; align-items: center;">  <p style="margin-left: 600px;">PROGRAM button</p> <div style="margin: 10px 0;">↓</div>  <p style="margin-left: 600px;">PROGRAM screen appears</p> <ul style="list-style-type: none"> • If Program name and Parameter are displayed in the column of the Program No., it indicates that the run parameters has been already stored in this program. • If you want to create the program, press the column where Program name and Parameter have not been displayed. </div>

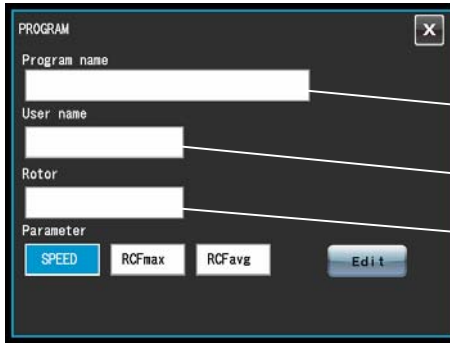
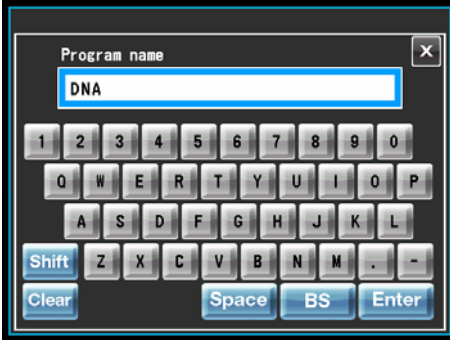
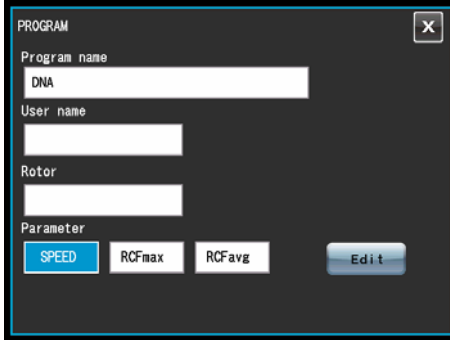
Process	Touch panel operation	Screen display and notice
2	<p>Press the column of the program No. that you want to create (change) the program. Check that the pressed column turns blue and press the Select button.</p> <p>If you want to change the contents of the program, change the desired item (see the note below).</p>	 <p>If you want to store the run parameters as Program No.4., press the column of the Program No.4.</p> <p>Select button</p> <p style="text-align: center;">↓</p>  <ul style="list-style-type: none"> • The PROGRAM screen appears Program name column User name column Rotor column
3	<p>Procedures for entering the program name are described as follows.</p> <p>a) Press the column of the program name in the PROGRAM screen.</p> <p>b) Enter the program name in the Program name screen.</p> <p>c) Press the Enter button.</p>	 <p>a) The Program name screen appears.</p> <p>b) If you enter the "DNA", the "DNA" is displayed on the column of the program name.</p> <p style="text-align: center;">↓</p>  <p>c) The PROGRAM screen returns to view.</p>

Process	Touch panel operation	Screen display and notice
4	<p>Procedures for selecting the user name are described as follows.</p> <p>a) Press the column of the user name in the PROGRAM screen.</p> <p>b) Select the user name and press the column of the selected user name. Then press the Enter button.</p>	<div data-bbox="683 322 1139 663"> <p>PROGRAM User name screen showing a table with columns: User name, Access level, Last Run. The 'Thermo' user is highlighted. An 'Enter' button is at the bottom.</p> </div> <p>a) The PROGRAM User name screen appears.</p> <p style="text-align: center;">↓</p> <div data-bbox="683 719 1139 1055"> <p>PROGRAM screen after selecting 'Thermo'. The 'User name' field is filled with 'Thermo'. Other fields include Program name (DNA), Rotor, and Parameter (SPEED, RCFmax, RCFavg). An 'Edit' button is present.</p> </div> <p>b) The PROGRAM screen returns to view. If you selected the "Thermo", the "Thermo" is displayed on the column of the user name.</p>

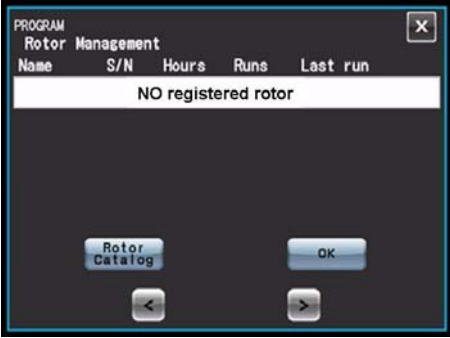
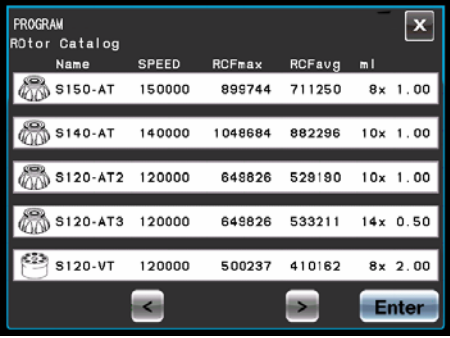
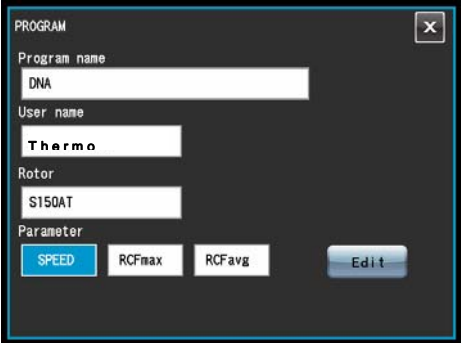
Process	Touch panel operation	Screen display and notice																														
5	<p>Procedures for selecting the rotor are described as follows.</p> <p>a) Press the column of the rotor in the PROGRAM screen.</p> <p>b) Press the Rotor Catalog button in the PROGRAM Rotor Management screen.</p> <p>c) Select the rotor in the PROGRAM ROTOR CATALOG screen and press the column of the selected rotor. Then press the Enter button.</p>	<p>a) The PROGRAM Management screen appears.</p>  <p>• You can select your rotor in the PROGRAM Rotor Management screen, if you registered your rotor in advance (see "Rotor Management" on page 2-49).</p> <p>b) The PROGRAM ROTOR CATALOG screen appears.</p>  <table border="1" data-bbox="687 875 1129 1144"> <thead> <tr> <th>Name</th> <th>SPEED</th> <th>RCFmax</th> <th>RCFavg</th> <th>ml</th> </tr> </thead> <tbody> <tr> <td>S150-AT</td> <td>150000</td> <td>898744</td> <td>711250</td> <td>8x 1.00</td> </tr> <tr> <td>S140-AT</td> <td>140000</td> <td>1048684</td> <td>882296</td> <td>10x 1.00</td> </tr> <tr> <td>S120-AT2</td> <td>120000</td> <td>648826</td> <td>529190</td> <td>10x 1.00</td> </tr> <tr> <td>S120-AT3</td> <td>120000</td> <td>648826</td> <td>533211</td> <td>14x 0.50</td> </tr> <tr> <td>S120-VT</td> <td>120000</td> <td>500237</td> <td>410162</td> <td>8x 2.00</td> </tr> </tbody> </table> <p>c) The PROGRAM screen returns to view. If you selected the "S150AT", the "S150AT" is displayed on the column of the Rotor.</p> 	Name	SPEED	RCFmax	RCFavg	ml	S150-AT	150000	898744	711250	8x 1.00	S140-AT	140000	1048684	882296	10x 1.00	S120-AT2	120000	648826	529190	10x 1.00	S120-AT3	120000	648826	533211	14x 0.50	S120-VT	120000	500237	410162	8x 2.00
Name	SPEED	RCFmax	RCFavg	ml																												
S150-AT	150000	898744	711250	8x 1.00																												
S140-AT	140000	1048684	882296	10x 1.00																												
S120-AT2	120000	648826	529190	10x 1.00																												
S120-AT3	120000	648826	533211	14x 0.50																												
S120-VT	120000	500237	410162	8x 2.00																												

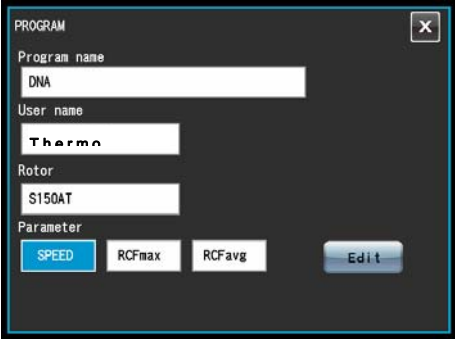
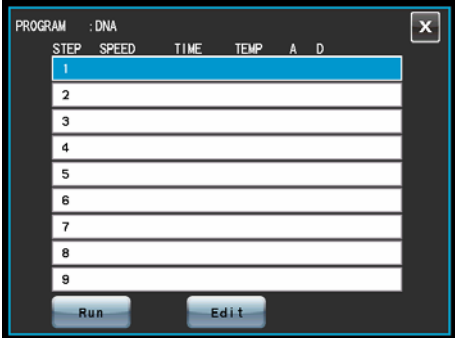
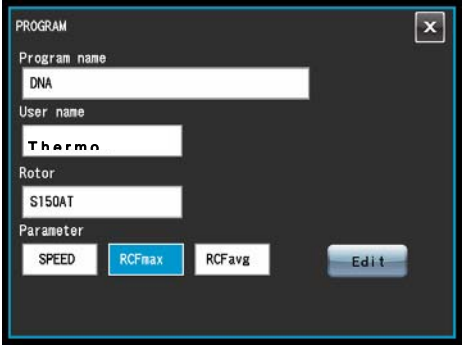
Process	Touch panel operation	Screen display and notice
6	<p>Procedures for selecting the run parameters are described as follows.</p> <p>[Entering the SPEED value]</p> <p>If you want to enter the SPEED value as the parameter, press the Edit button after checking that the color of the SPEED column is blue.</p>	 <p>SPEED column Edit button</p>  <ul style="list-style-type: none"> The Enter PROGRAM screen appears.
7	<p>[Entering the RCF value]</p> <p>If you want to enter the RCF value as the parameter, press the RCF_{max} (RCF_{avg}) column.</p> <p>Press the Edit button after checking that the color of the RCF_{max} (RCF_{avg}) column turns blue.</p>	 <p>RCF_{max} column RCF_{avg} column Edit button</p>

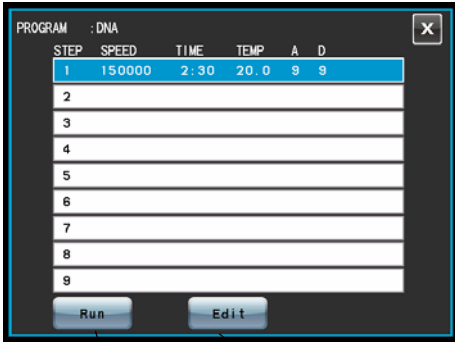
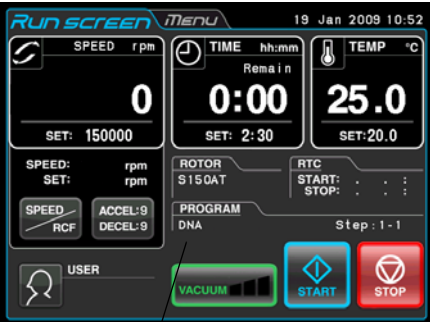

Process	Touch panel operation	Screen display and notice
8	<p>Procedures for entering the run parameters are described as follows.</p> <p>a) Press the Edit button after checking that the color of the STEP1 column is blue. Enter the run parameters on the keypad display (see “Preparing tubes/bottles and rotors” on page 2-3).</p> <p>If you want to enter the acceleration and deceleration rate, press the ACCEL/DECEL button.</p> <div style="border: 1px solid black; padding: 5px; margin: 10px 0;"> <p>Example: SPEED:150,000 rpm TIME:2hr.30min. TEMP:20°C ACCEL:9</p> </div> <p>b) Press the OK button after entering the run parameters. (If you want to change the run parameters, press the column of the desired STEP. Press the Edit button after checking that the pressed column is blue and enter the run parameters.)</p>	 <p>a) The keypad display is shown.</p> <p>ACCEL/DECEL button OK button</p>  <p>b) The entered run parameters are displayed in the Enter PROGRAM screen.</p> <p>Run button Edit button</p> <ul style="list-style-type: none"> To enter the run parameters in multiple steps in a step-mode operation, continue the operation from the above (see “Step-mode operation” on page 2-30). You can not skip a step. (You can not enter anything in STEP 2 with nothing entered into STEP1.)
9	<p>Press the Run button in the PROGRAM screen</p>	 <p>• The Run screen appears.</p> <p>Program name</p>



Note 1. If you make and store changes in a column that already stores run parameters, the previous parameters are replaced by the new parameters.
 2. You cannot store a run parameter while in running (while the rotor is rotating). Always perform this function while not in running.

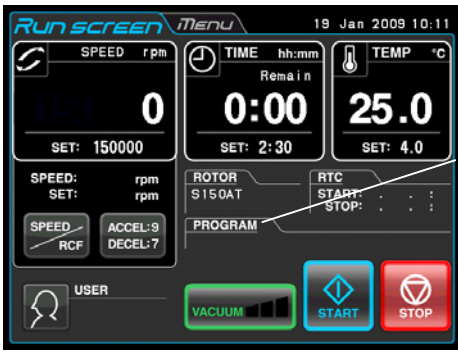

1. How to perform a programmed operation

Shown below is how to perform a “programmed operation”, that is, how to call a stored set of run parameters and run this micro-ultracentrifuge accordingly.

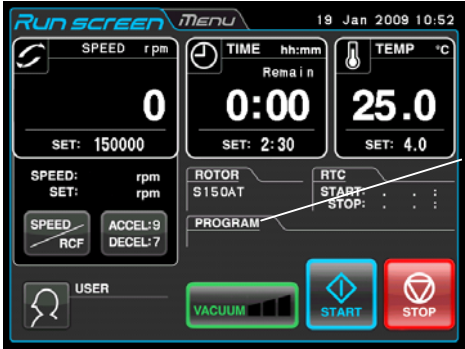
(a) If you know the program name you need.

Process	Touch panel operation	Screen display and notice
1	Turn on the POWER switch on the micro-ultracentrifuge.	<ul style="list-style-type: none"> • Touchscreen appears. • The door unlocks.
2	Install a rotor.	<ul style="list-style-type: none"> • Install the rotor securely on the shaft. (The rotor does not have to be screwed into the shaft.) • Always use a quick setting rotor (see “Applicable rotors” on page 2-4.)
3	Press the PROGRAM button on the Run screen.	<div style="text-align: center;">  <p>PROGRAM button</p> </div> <div style="text-align: center; margin: 10px 0;">  </div> <div style="text-align: center;">  <ul style="list-style-type: none"> • The PROGRAM screen appears. </div>

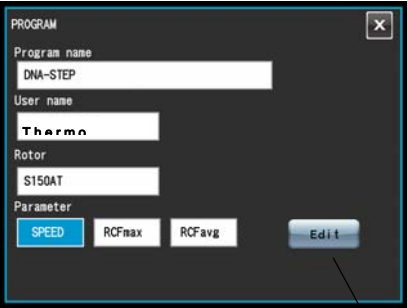
Process	Touch panel operation	Screen display and notice
3	Press the PROGRAM button on the Run screen.	 <p style="text-align: center;">↓</p>  <ul style="list-style-type: none"> • The PROGRAM screen appears.



Process	Touch panel operation	Screen display and notice
<p>4</p> <p>Press the column of the desired program name whose contents you want to check. Then press the Select button after checking that the pressed column turns blue.</p> <p>Check the user name and rotor name in the Program screen and decide whether this selected program is the program that you need or not.</p> <p>If you think that the selected program is the program you need, press the Edit button to check the run parameters.</p> <p>If you do not think that the selected program is the program you need, press the x button to switch to the previous screen.</p> <p>After checking the run parameters, press the Run button if the selected program is the program you need.</p> <p>STEP: 1-3</p> <p>In this case, this program has three steps. In the Run screen, the run parameters for the first step in this program are displayed.</p>	<p>Press the column of the desired program name whose contents you want to check. Then press the Select button after checking that the pressed column turns blue.</p> <p>Check the user name and rotor name in the Program screen and decide whether this selected program is the program that you need or not.</p> <p>If you think that the selected program is the program you need, press the Edit button to check the run parameters.</p> <p>If you do not think that the selected program is the program you need, press the x button to switch to the previous screen.</p> <p>After checking the run parameters, press the Run button if the selected program is the program you need.</p> <p>STEP: 1-3</p> <p>In this case, this program has three steps. In the Run screen, the run parameters for the first step in this program are displayed.</p>	 <p>Select button</p>  <p>Edit button</p>  <p>Run button</p>  <p>Program name</p> <ul style="list-style-type: none"> • The program name is displayed on the PROGRAM button indicator. • If the "STEP:1-3" is displayed on the PROGRAM button indicator, this means that the program you have just called stores multiple run parameters (step-mode feature). For details, see "Step-mode operation" on page 2-30.
<p>5</p> <p>Run the micro-ultracentrifuge under normal operation without making changes to the run parameters.</p>	<p>Run the micro-ultracentrifuge under normal operation without making changes to the run parameters.</p>	<ul style="list-style-type: none"> • Run this micro-ultracentrifuge according to "Operational procedure" on page 2-11. • If you make changes to the run parameters (such as SPEED and TIME) after calling a program, the program you have just called is canceled. You must call it again to use it.



Note 1. To perform a combination of a programmed run with RTC (real-time control) (see “RTC (real-time control) operation” on page 2-1), call a programmed memory unit, then set RTC. The system will then calculate the total of the running times of all steps of the programmed run and calculate the start time for RTC. Therefore, cannot call the program memory after setting RTC.

2. Deleting a program

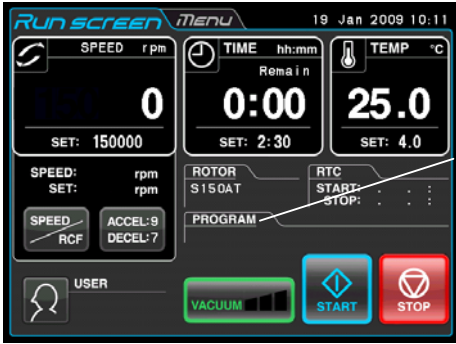
This section explains how to delete a program.
To delete a program, delete all steps in that program.

Note You cannot delete a program while in running (while the rotor is rotating). Always perform this function while not in running.

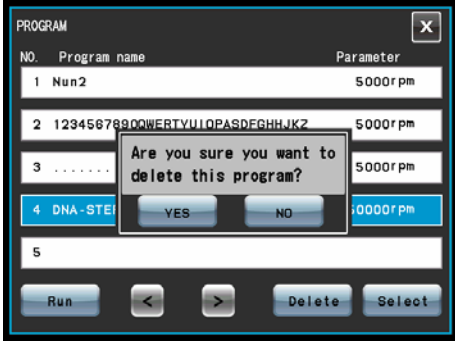
Process	Touch panel operation	Screen display and notice
1	Press the PROGRAM button on the Run screen.	 <p style="text-align: center;">↓</p>  <p>PROGRAM button</p> <ul style="list-style-type: none"> • The PROGRAM screen appears.

Process	Touch panel operation	Screen display and notice
2	Press the column of the program name which you want to delete. Then press the Delete button after checking that the pressed column turns blue.	 <ul style="list-style-type: none"> The deletion confirmation box is displayed.
3	Press the Yes button on the deletion confirmation box.	 <ul style="list-style-type: none"> The program is deleted.

Step-mode operation

This micro-ultracentrifuge incorporates a step-mode operation feature, which stores two or more run conditions in one program memory area and switches between different values of speed, running time, temperature, and other parameters while in operation. This micro-ultracentrifuge can store up to nine steps.

This section explains how to make settings by citing some examples.

1. How to activate a step-mode operation

[Typical settings]

Shown below is the example of a three-step run and how to activate a step-mode operation.

	Step 1	Step 2	Step 3
Speed	150,000 rpm	120,000 rpm	100,000 rpm
Run time	1 h 30 min	1 h	30 min
Temperature	20°C	20°C	20°C
Acceleration mode	9	9	9
Deceleration mode	9	9	7

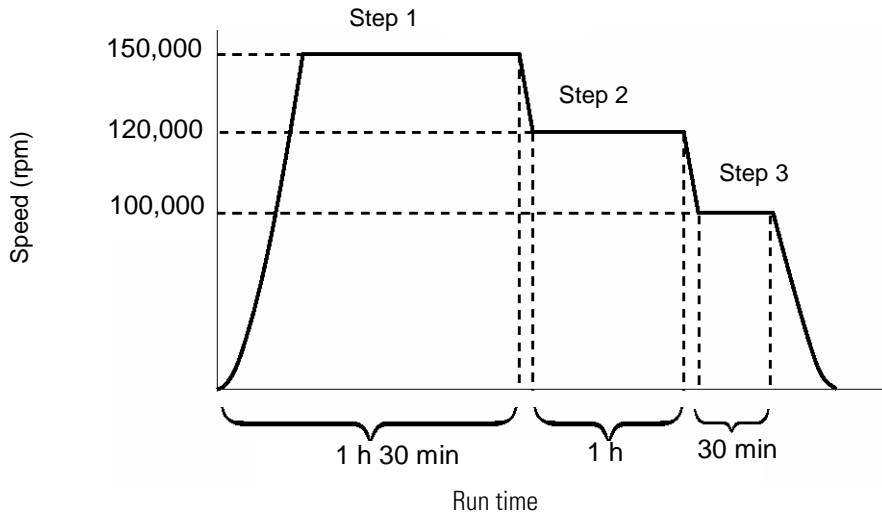
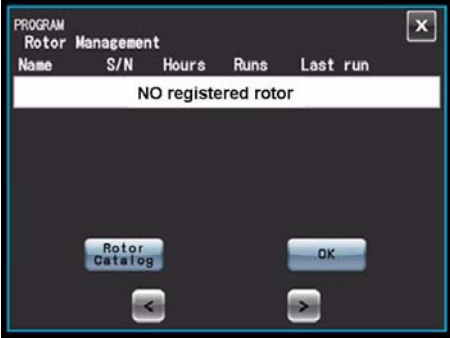

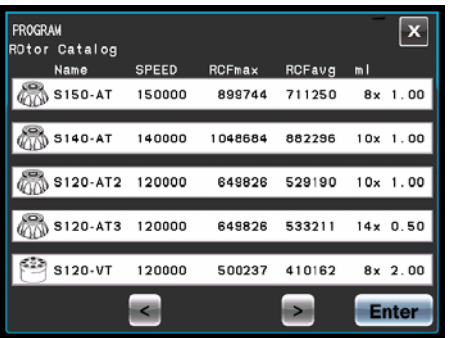



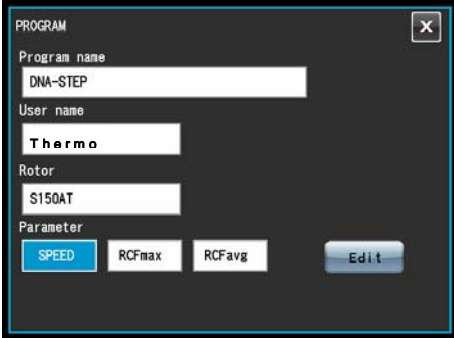

Figure 2-9. A typical step-mode run



Process	Touch panel operation	Screen display and notice
1	Press the PROGRAM button on the Run screen.	<div data-bbox="708 1055 1166 1395" style="border: 1px solid black; padding: 5px;"> </div> <p style="text-align: right; margin-right: 20px;">PROGRAM button</p> <div data-bbox="708 1458 1166 1798" style="border: 1px solid black; padding: 5px; margin-top: 10px;"> </div> <ul style="list-style-type: none"> • The PROGRAM screen appears. • If a Program name and Parameter are displayed in the column of a Program No., run parameters have already been stored for that program. • If you want to create a new program, press a column that does not display a Program name or Parameter.

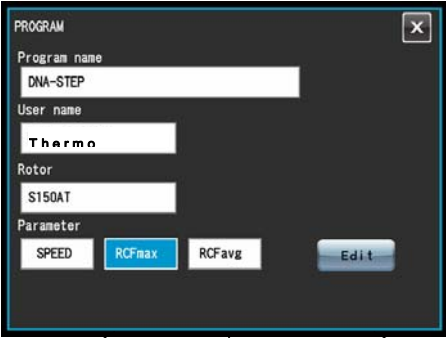

Process	Touch panel operation	Screen display and notice
2	<p>Press the column of the program No. for which you want to create (or change) a program, and make sure that the pressed column turns blue.</p> <p>Then press the Select button.</p>	<div data-bbox="710 315 1161 651"> </div> <p data-bbox="1209 315 1444 472">If you want to store the run parameters as Program No.4., press the column of the Program No.4.</p> <p data-bbox="1209 555 1342 584">Select button</p> <p data-bbox="901 656 949 705">↓</p> <div data-bbox="710 712 1166 1048"> </div> <ul data-bbox="1209 712 1374 965" style="list-style-type: none"> • The PROGRAM screen appears. • Program name column • User name column • Rotor column <ul data-bbox="710 1064 1453 1189" style="list-style-type: none"> • If a Program name and Parameter are displayed in the column of a Program No., run parameters have already been stored for that program. • If you want to create a new program, press a column that does not display a Program name or Parameter.
3	<p>Enter a program name as follows:</p> <p>a) Press the column of the program name in the PROGRAM screen.</p> <p>b) Enter the program name in the Program name screen.</p> <p>c) Press the Enter button.</p>	<div data-bbox="710 1249 1118 1563"> </div> <p data-bbox="1141 1249 1342 1301">a) The Program name screen appears.</p> <p data-bbox="1141 1339 1366 1525">b) If you enter the "DNA-STEP", these characters are displayed on the column of the program name.</p> <p data-bbox="890 1563 938 1612">↓</p> <div data-bbox="710 1608 1118 1899"> </div> <p data-bbox="1141 1608 1374 1659">c) The PROGRAM screen reappears.</p>

Process	Touch panel operation	Screen display and notice												
4	<p>Select a user name as follows:</p> <p>a) Press the column of User name in the PROGRAM screen.</p> <p>b) Press the column of the user name you want to select. Then press the Enter button.</p>	<div data-bbox="715 322 1169 663"> <table border="1"> <thead> <tr> <th>User name</th> <th>Access level</th> <th>Last Run</th> </tr> </thead> <tbody> <tr> <td>Admin</td> <td>Administrator</td> <td>05 Dec 2008 10:15</td> </tr> <tr> <td>GGG</td> <td>Administrator</td> <td>02 Dec 2008 10:09</td> </tr> <tr> <td>Thermo</td> <td>Administrator</td> <td></td> </tr> </tbody> </table> </div> <p>a) The PROGRAM User name screen appears.</p> <div data-bbox="911 667 954 719"> </div> <div data-bbox="715 730 1169 1070"> </div> <p>b) The PROGRAM screen reappears. If you selected the "Thermo", these characters are displayed on the column of the user name.</p>	User name	Access level	Last Run	Admin	Administrator	05 Dec 2008 10:15	GGG	Administrator	02 Dec 2008 10:09	Thermo	Administrator	
User name	Access level	Last Run												
Admin	Administrator	05 Dec 2008 10:15												
GGG	Administrator	02 Dec 2008 10:09												
Thermo	Administrator													

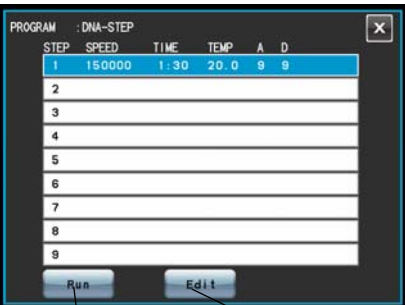
Process	Touch panel operation	Screen display and notice
5	<p>Select a rotor as follows:</p> <p>a) Press the column of the rotor in the PROGRAM screen.</p> <p>b) Press the Rotor Catalog button in the PROGRAM Rotor Management screen.</p> <p>c) In the PROGRAM ROTOR CATALOG screen, press the column of the rotor you want to select. Then press the Enter button.</p>	<div style="display: flex; justify-content: space-between;"> <div style="width: 60%;">  <p>a) The Program Rotor Management screen appears.</p> </div> <div style="width: 35%;"> <p>a) The Program Rotor Management screen appears.</p> </div> </div> <p>• If you registered your rotor in advance (see “Rotor Management” on page 2-49), you can select it in this PROGRAM Rotor Management screen,</p> <div style="text-align: center; margin: 10px 0;">  </div> <div style="display: flex; justify-content: space-between;"> <div style="width: 60%;">  <p>b) The PROGRAM ROTOR CATALOG screen appears..</p> </div> <div style="width: 35%;"> <p>b) The PROGRAM ROTOR CATALOG screen appears..</p> </div> </div> <div style="text-align: center; margin: 10px 0;">  </div> <div style="display: flex; justify-content: space-between;"> <div style="width: 60%;">  <p>c) The PROGRAM screen reappears. If you selected the “S150AT”, these characters are displayed on the column of the Rotor.</p> </div> <div style="width: 35%;"> <p>c) The PROGRAM screen reappears. If you selected the “S150AT”, these characters are displayed on the column of the Rotor.</p> </div> </div>

Process	Touch panel operation	Screen display and notice
6	<p>Select run parameters as follows:</p> <p>[To enter a SPEED value] If you want to enter a SPEED value as a parameter, press the SPEED column and make sure that it turns blue. Then press the Edit button.</p>	 <p>SPEED column Edit column</p>  <ul style="list-style-type: none"> • The Enter PROGRAM screen appears.
	<p>[To enter a RCF value] If you want to enter a RCF value as a parameter, press the RCF_{max} (or RCF_{avg}) column and make sure that it turns blue. Then press the Edit button.</p>	 <p>RCF_{max} column RCF_{avg} column Edit button</p>

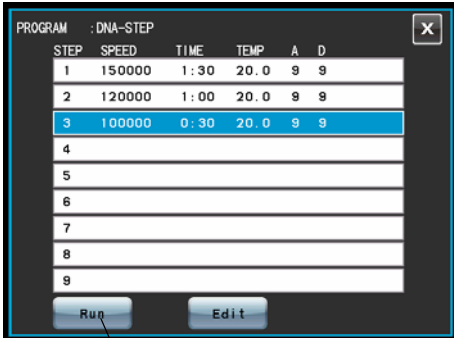
Process	Touch panel operation	Screen display and notice
7	<p>Enter run parameters as follows:</p> <p>a) Make sure that the STEP 1 column is blue, and then press the Edit button. Enter the run parameters for the STEP 1 on the keypad display (see “Preparing tubes/bottles and rotors” on page 2-3). If you want to enter an acceleration or deceleration rate, press the ACCEL/DECEL button.</p> <div data-bbox="247 589 635 786" style="border: 1px solid black; padding: 5px; margin: 10px 0;"> <p>Run parameters of the STEP 1: SPEED: 150,000 rpm TIME: 1hr.30min. TEMP: 20°C ACCEL: 9 DECEL: 9</p> </div> <p>b) After entering the run parameters, press the OK button (If you want to change run parameters, press the column of the desired STEP, and make sure that it turns blue. Then press the Edit button.</p> <p>c) Enter the run parameters for STEP 2 on the keypad display in a similar way.</p> <div data-bbox="247 1055 635 1252" style="border: 1px solid black; padding: 5px; margin: 10px 0;"> <p>Run parameters of the STEP 2: SPEED: 120,000 rpm TIME: 1hr. TEMP: 20°C ACCEL: 9 DECEL: 9</p> </div> <p>d) Enter the run parameters for the STEP 3 on the keypad display in a similar way.</p> <div data-bbox="247 1357 635 1590" style="border: 1px solid black; padding: 5px; margin: 10px 0;"> <p>Run parameters of the STEP 3: SPEED: 100,000 rpm TIME: 30min. TEMP: 20°C ACCEL: 9 DECEL: 9</p> </div>	<p>Screen display and notice</p>  <p>a) The keypad display appears.</p>  <p>b) The run parameters entered for STEP 1 are displayed in the Enter PROGRAM screen.</p> <ul style="list-style-type: none"> You can not skip a step. (If you enter nothing in STEP 1, you cannot enter anything in STEP 2.)  <p>c) The run parameters entered for STEP 2 are displayed in the Enter PROGRAM screen.</p>  <p>d) The run parameters entered for STEP 3 are displayed in the Enter PROGRAM screen.</p>

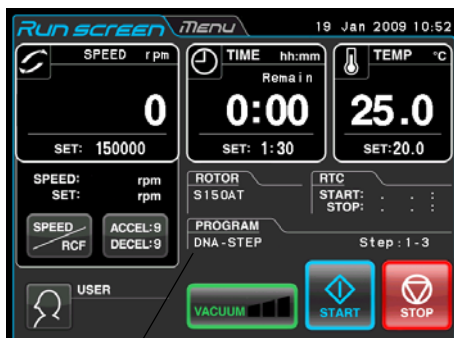
Process	Touch panel operation	Screen display and notice
8	Press the Run button in the PROGRAM screen.	 <p>Run button</p>   <p>Program name</p> <ul style="list-style-type: none"> • The Run screen appears.
9	Run the micro-ultracentrifuge under normal operation without changing to the run parameters.	<ul style="list-style-type: none"> • Run the micro-ultracentrifuge according to “Operational procedure” on page 2-11. • If you change to a run parameters (such as SPEED or TIME) after calling a program, the program you have just called is canceled. You must call it again to use it. • Pressing the START button rotates the rotor under the run parameters of STEP 1. • When STEP 1 ends, the system moves to STEP 2 and STEP 3 automatically.

1. Step display

The PROGRAM button indicator displays steps as follows:

STEP:1-3

In this case, this program contains three steps.

In the Run screen, the run parameters for the first step in this program are displayed.



When the system finishes separating step 1 and moves to step 2,

STEP:2-3

- Note** 1. Selecting the rotor is required to display and set an RCF value (see “Displaying and setting RCF” on page 2-38).
2. You can select your rotor in the Rotor Management screen, if you registered your rotor in advance (see “Rotor Management” on page 2-49).
3. Selecting the rotor is required when the rotor lockout function is enabled (see “Administrator (Admin) functions” on page 2-62 (3) “Rotor Lockout”).

Displaying and setting RCF

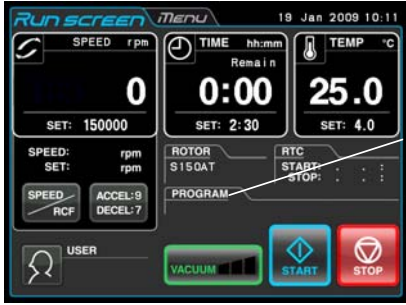
This micro-ultracentrifuge stores the maximum and average radii of each rotor in the internal memory. Setting a speed causes this micro-ultracentrifuge to automatically calculate and display the RCF (relative centrifugal force) value, while setting an RCF value causes the micro-ultracentrifuge to automatically calculate and display the speed. Given below is a description of how to display and set RCF.

Process	Touch panel operation	Screen display and notice
1	Press the PROGRAM button on the Run screen.	 <p>PROGRAM button</p> <p>↓</p>  <ul style="list-style-type: none"> • The PROGRAM screen appears.
2	Press the column of the program name which you want to delete. Then press the Delete button after checking that the pressed column turns blue.	 <ul style="list-style-type: none"> • The deletion confirmation box is displayed.

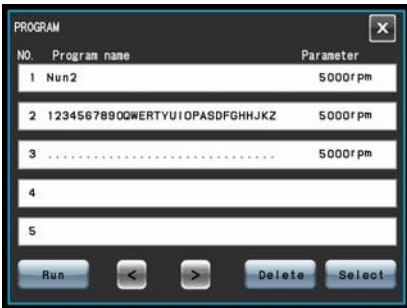
Process	Touch panel operation	Screen display and notice
3	Press the Yes button on the deletion confirmation box.	 <ul style="list-style-type: none"> The program is deleted.

1. Other procedures



- 1. Making changes to the run parameters**
 Call the memory unit you want to make changes to and make the changes. Alternatively, delete the memory unit, then store a new set of run parameters.
 To make a change that will result in fewer steps, delete the memory unit and then enter a new set of run conditions and store them.
- 2. Running the micro-ultracentrifuge starting from an intermediate step**
 You cannot run the micro-ultracentrifuge starting from an intermediate step in a memory unit that contains multiple steps.
 Store (register) run parameters for the intermediate step and later steps in another memory unit. Then call the memory unit and run it.
- 3. What if a SPEED alarm goes on?**
 If a step stores a speed exceeding the maximum allowable speed of your rotor, the system will detect it in the STEP1 run and display the SPEED alarm.
 Double-check the speed of all steps and correct any wrong ones.
- 4. Stopping the micro-ultracentrifuge in operation**
 Press STOP button. The rotor stops and the system does not move to the next step.

Selecting the rotor

This micro-ultracentrifuge stores the maximum and average radii of each rotor in the internal memory. Setting a speed causes this micro-ultracentrifuge to automatically calculate and display the RCF (relative centrifugal force) value, while setting an RCF value causes the micro-ultracentrifuge to automatically calculate and display the speed.

You can control the rotor data such as total operation hours and number of runs by registering your rotors in the micro-ultracentrifuge.

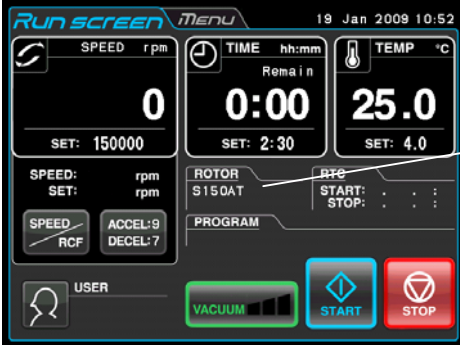
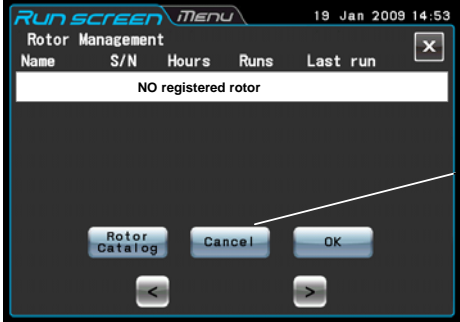
- (1) Procedure for selecting the rotor.

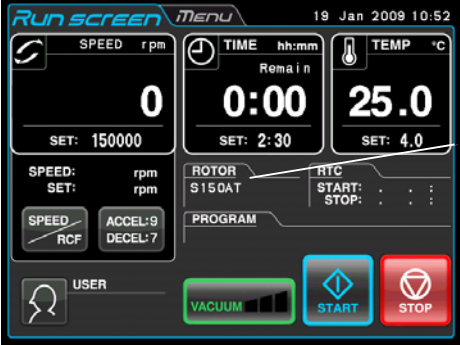
Process	Touch panel operation	Screen display and notice
1	<p>Check that the desired rotor is displayed in the ROTOR indicator of the RUN SCREEN. When the desired rotor is not displayed, press the ROTOR indicator.</p>	 <p>• ROTOR indicator</p>
2	<p>Check whether the desired rotor is displayed in the Rotor Management screen or not. When the desired rotor is displayed, press the column of the desired rotor and press the OK button. When the desired rotor is not displayed, press the Rotor Catalog button.</p>	 <ul style="list-style-type: none"> • The Rotor Management screen appears. Nothing is displayed in the ROTOR indicator by pressing the Cancel button. • You can select your rotor in the Rotor Management screen, if you registered your rotor in advance (see "Rotor Management" on page 2-49).
3	<p>Press the column of the desired rotor on the ROTOR CATALOG screen. Check that the pressed column turns blue and press the Enter button.</p>	 <ul style="list-style-type: none"> • The ROTOR CATALOG screen appears. • The pressed column turns from white to blue.
4	<p>The desired rotor is displayed in the ROTOR indicator of the Run screen.</p>	 <ul style="list-style-type: none"> • The Run screen returns to view. • ROTOR indicator

Note 1. Selecting the rotor is required to display and set an RCF value (see “Displaying and setting RCF” on page 2-41).



2. You can select your rotor in the Rotor Management screen, if you registered your rotor in advance (see “Rotor Management” on page 2-49).



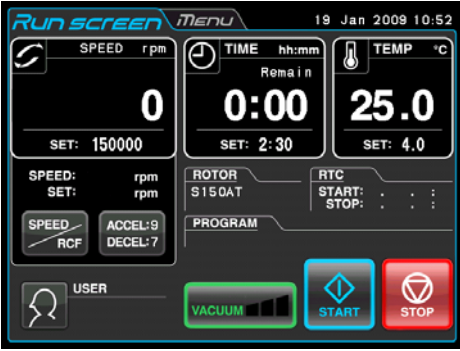

3. Selecting the rotor is required when the rotor lockout function is enabled (see “Administrator (Admin) functions” on page 2-62 (3) “Rotor Lockout”).

Displaying and setting RCF

This micro-ultracentrifuge stores the maximum and average radii of each rotor in the internal memory. Setting a speed causes this micro-ultracentrifuge to automatically calculate and display the RCF (relative centrifugal force) value, while setting an RCF value causes the micro-ultracentrifuge to automatically calculate and display the speed. Given below is a description of how to display and set RCF.



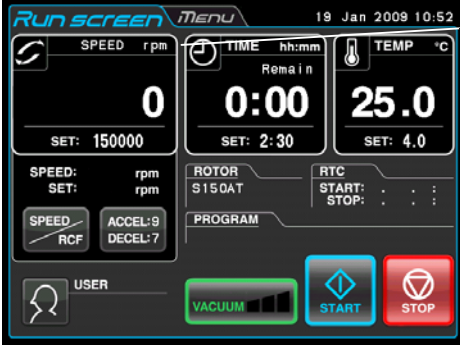

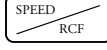
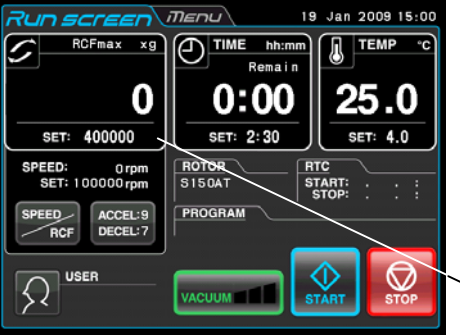
1. How to display an RCF value

Process	Touch panel operation	Screen display and notice
1	Check that the desired rotor is displayed in the ROTOR indicator of the Run screen. Go to step 3 when the desired rotor is displayed. When the desired rotor is not displayed, press the ROTOR indicator to show the ROTOR CATALOG screen.	 <p>ROTOR indicator</p>
2	Press the column of the rotor you want to see the RCF value. The column turns from white to blue. Check that the pressed column turns blue and press the Enter button.	 <p>The pressed column turns from white to blue.</p>

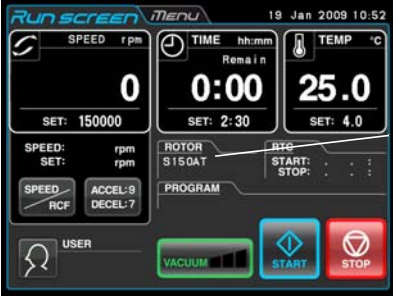
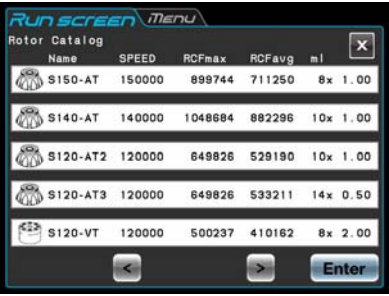

Process	Touch panel operation	Screen display and notice
3	<p>When RCF_{max} or RCF_{avg} is displayed in the  column,</p> <p>touch the  button to</p> <p>show SPEED in the SPEED column. Press the SPEED column and enter the SPEED value you want to convert into the RCF value with the keypad display.</p> <p>(e.g.) Rotor: S150AT SPEED: 100,000 rpm</p> <p>Press <input type="text" value="1"/> <input type="text" value="0"/> <input type="text" value="0"/> , and press the Enter button to enter the setting.</p>	<ul style="list-style-type: none"> See "Setting run conditions" on page 2-5  <p style="text-align: center;">↓</p> 
4	<p>Press the  button to</p> <p>turn the SPEED column to the RCF_{max} column or the RCF_{avg} column.</p>	 <ul style="list-style-type: none"> The RCF value of the rotor displayed in the ROTOR indicator is displayed on the setting value display field of the RCF column. <p>This is the RCF value for the SPEED value entered in step 3.</p> <p>RCF_{max} column: The maximum RCF value for the rotor set speed is displayed.</p> <p>RCF_{avg} column: The average RCF value for the rotor set speed is displayed.</p>

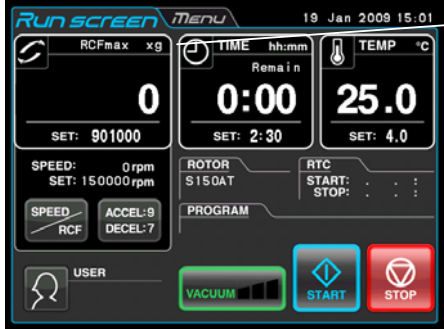
2. How to set an RCF value

Select the desired rotor and enter an RCF value, and the micro-ultracentrifuge will calculate, set, and display the speed. Shown below is the procedure

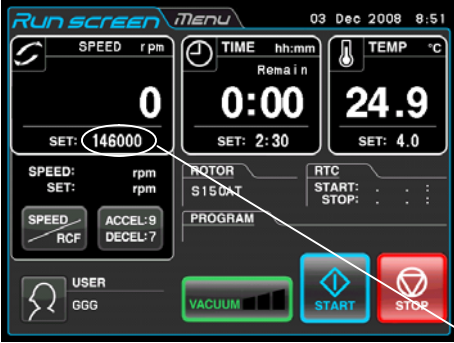
Process	Touch panel operation	Screen display and notice
1	<p>Check that the desired rotor is displayed in the ROTOR indicator of the Run screen. Go to step 3 when the desired rotor is displayed. When the desired rotor is not displayed, press the ROTOR column to show the ROTOR CATALOG screen.</p>	 <p>ROTOR indicator</p>
2	<p>Press the column of the rotor you want to see the RCF value. The column turns from white to blue. Check that the pressed column turns blue and press the Enter button.</p>	 <p>The pressed column turns from white to blue.</p>
3	<p>When "SPEED" is displayed in the  column, press the  button to show "RCF_{max}" ("RCF_{avg}") in the RCF_{max} (RCF_{avg}) column. Press the RCF_{max} (RCF_{avg}) column and enter the SPEED value you want to convert into the SPEED value with the keypad display. (e.g.) Rotor: S150AT RCF_{max}: 850x1,000 xg Press <input type="text" value="8"/> <input type="text" value="5"/> <input type="text" value="0"/>, and press the Enter button to enter the setting.</p>	<ul style="list-style-type: none"> See "Setting run conditions" on page 2-5.  <p>RCF_{max} column</p> 

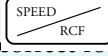
Process	Touch panel operation	Screen display and notice
4	Press the  button to turn the RCF _{max} (RCF _{avg}) column to the SPEED column.	 <ul style="list-style-type: none"> The SPEED value of the rotor displayed in the ROTOR indicator is displayed on the setting value display field of the SPEED column. <p>This is the SPEED value for the RCF value entered in step 3.</p>

Note 1. To shift from the SPEED column to the RCF column, press the  button.
 2. This micro-ultracentrifuge is not capable of checking rotors. Select the  rotor. Especially when you wish to determine a speed based on an RCF value, selecting the wrong rotor and thus setting an RCF value exceeding the capacity of your rotor will cause the system to calculate and set a speed exceeding the maximum allowable speed. (However, this micro-ultracentrifuge has an overspeed detector, which prevents an overspeed run.)
 3. When you run this micro-ultracentrifuge at a speed determined based on an RCF value, there may occur a slight error (of up to 2%) between the set RCF value and the actual value, because the speed setting is set in increments of 1,000 rpm.

User login

After logging in, individual users can control the operation history of the micro-ultracentrifuge.

1. Procedure for user login

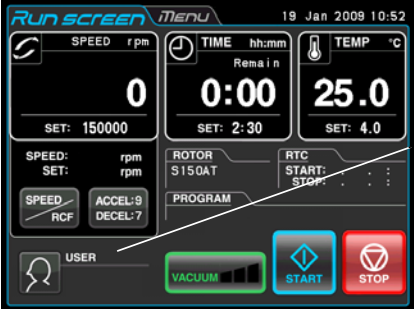
Process	Touch panel operation	Screen display and notice
1	Press the USER column on the Run screen.	 <p>USER column</p>

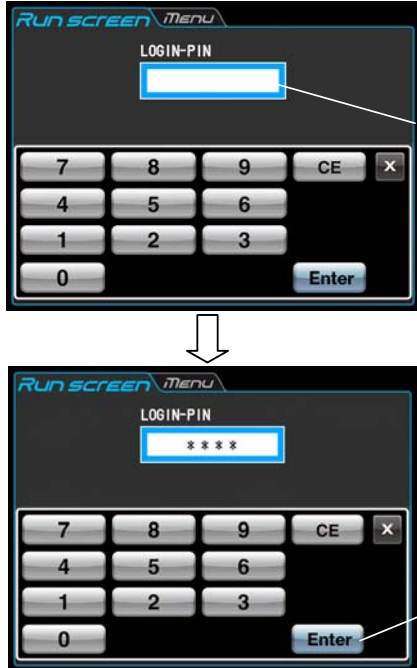
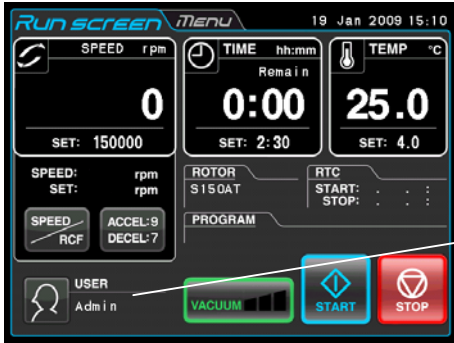
Process	Touch panel operation	Screen display and notice
2	<p>Press the column of the desired user name on the User Management screen. Check that the pressed column turns blue and press the LOGIN button.</p> <p>("Admin" was registered as a user name for this micro- ultracentrifuge before shipment.)</p>	 <ul style="list-style-type: none"> The User Management screen appears. The pressed column turns from white to blue. LOGIN button
3	<p>Enter the desired PIN on the keypad display and press the Enter button.</p> <p>PIN is the number (4 digits) which you entered on the PIN registration screen (see "Administrator (Admin) functions" on page 2-62 (1)).</p> <p>("1111" is the PIN of "Admin" registered as a user name for this micro-ultracentrifuge before shipment. If necessary, change the PIN.)</p>	 <ul style="list-style-type: none"> The login screen appears. PIN box The masked PIN is displayed. Enter button
4	<p>The user name is displayed on the user column of the Run screen.</p>	 <ul style="list-style-type: none"> Run screen returns to view. USER column

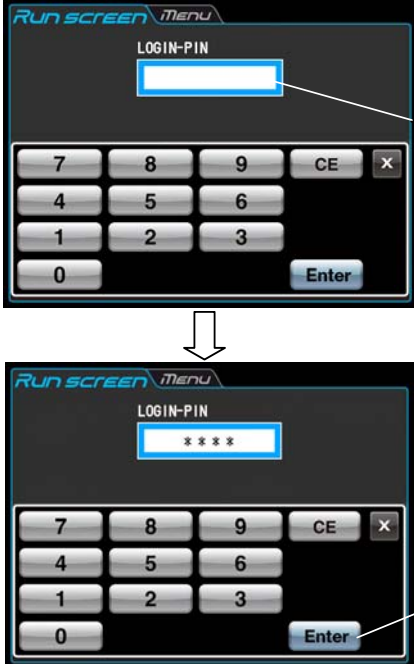
Process	Touch panel operation	Screen display and notice
3	<p>Enter the desired PIN on the keypad display and press the Enter button.</p> <p>PIN is the number (4 digits) which you entered on the PIN registration screen (see “Administrator (Admin) functions” on page 2-62 (1)).</p> <p> (“1111” is the PIN of “Admin” registered as a user name for this micro-ultracentrifuge before shipment. If necessary, change the PIN.)</p>	 <ul style="list-style-type: none"> • The login screen appears. • The masked PIN is displayed. <p>PIN box</p> <p>Enter button</p>

Note 1. User login is required to start operation when the user lockout function has been enabled as described in “Administrator (Admin) functions” on page 2-62 (2) “User Lockout.” You cannot operate the micro-ultracentrifuge without logging in. Perform registration according to “Administrator (Admin) functions” on page 2-62 “User Management” before attempting to log in.





Features of the MENU screen

The Menu screen appears by pressing the MENU screen tab on the Touchscreen. These features are designed to allow you to use the Sorvall MTX 150 micro-ultracentrifuge with additional options (see Figure 2-10).



Figure 2-10. MENU screen

The functions of each icon on the MENU screen are described in the table below.

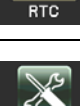
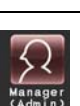
Function	Icon	Description
Run History		The information about the run parameters of a previous normal operation can be stored automatically in the micro-ultracentrifuge and you can load it for a new run (see “Displaying the Run History and loading the information about run parameters” on page 2-47).
Rotor Catalog		You can view the applicable rotor names and their specifications (see “Rotor Catalog” on page 2-48).
Rotor Management		You can use and control the rotor data such as total operation hours and number of runs (see “Rotor Management” on page 2-49).
Spin-down operation		While you press the PULSE button on the Run screen and are holding down it, the micro-ultracentrifuge accelerates up to the set speed at the maximum acceleration rate. When you release this button, it starts deceleration. This feature is useful to remove the adhered samples on the interior walls of the tubes (see “Spin-down operation” on page 2-53).
RTC (real-time control) operation		Run starts or completes at a required date and time (see “RTC (real-time control) operation” on page 2-1).
Customize		You can select rotor stop signal etc. which enable you to easily run the micro-ultracentrifuge (see “Customizing the settings” on page 2-58).
Manager (Admin)		You can set the items which the administrator should set such as language (see “Administrator (Admin) functions” on page 2-62).

Press the desired icon. Then the corresponding item is displayed.

Displaying the Run History and loading the information about run parameters

The information about the run parameters of a previous normal operation can be stored automatically in the micro-ultracentrifuge and you can load it for a new run.

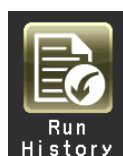

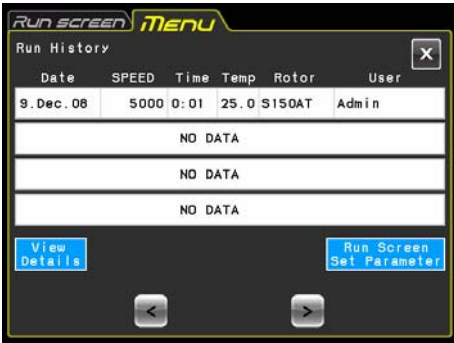
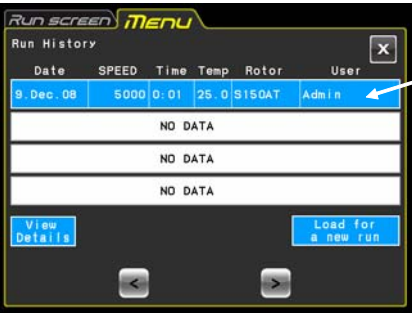
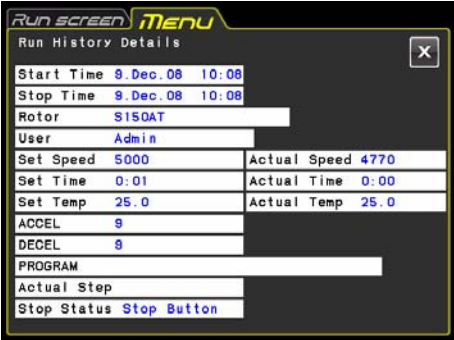
Process	Touch panel operation	Screen display and notice
1	Press the Run History icon on the MENU screen.	 <ul style="list-style-type: none"> The Run History screen appears.
2	<p>If you want to load the information about the run parameters for a new run, press the column of the information which you want to load for a new run. The column turns from white to blue.</p> <p>Check that the pressed column turns blue and press the Load for a new run button.</p>	
	If you want to check the details of the selected information, press the View Details button.	 <ul style="list-style-type: none"> The Run History Details screen appears.
3	Press the Run screen tab to return to the Run screen.	The Run screen appears.

Rotor Catalog

You can view the applicable rotor names and their specifications.



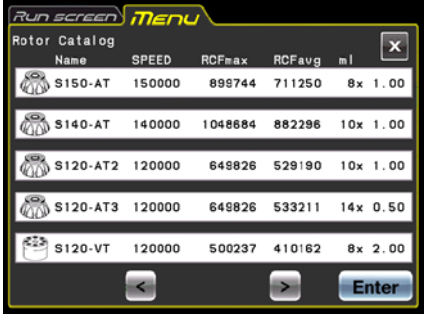



Process	Touch panel operation	Screen display and notice
1	<p>Press the Rotor Catalog icon on the MENU screen.</p> <p><: Previous Page button >: Next Page button</p>	 <p>• The Rotor Catalog screen appears.</p> <p>Numbers of tubes x ml</p>
2	<p>If you want to view the MENU screen, press the x button or MENU screen tab.</p> <p>If you want to view the Run screen, press the Run screen tab.</p>	<ul style="list-style-type: none"> • The MENU screen appears. • The Run screen appears.

Rotor Management



You can use and control the rotor data such as total operation hours and number of runs by registering your rotors in the micro-ultracentrifuge in advance. (It is recommended to use the rotor lockout function (see “Administrator (Admin) functions” on page 2-62 (3)) together in order to control the rotor data such as total operation hours and number of runs.)



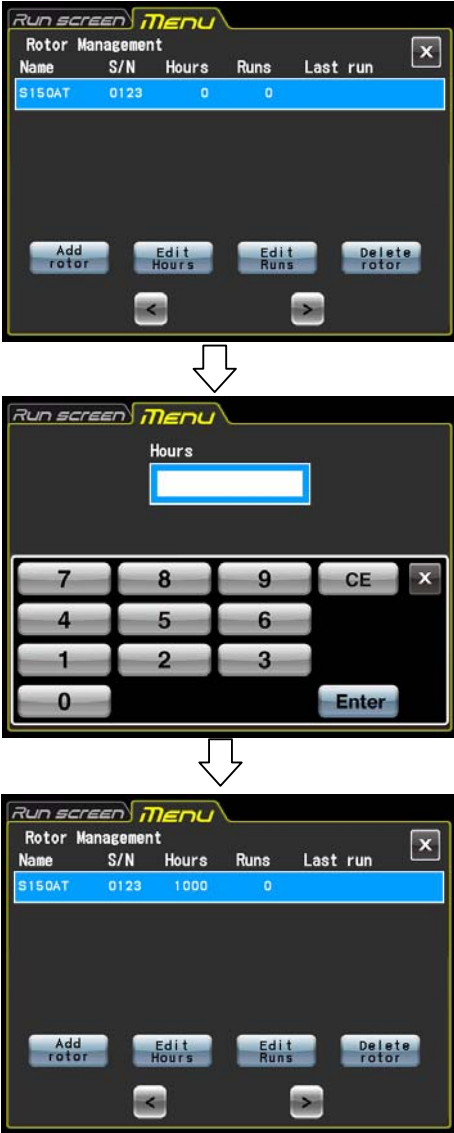

(1) Registering the rotor

Process	Touch panel operation	Screen display and notice
1	<p>Procedures for registering the rotor are described as follows.</p> <p>a) Press the Rotor Management icon on the MENU screen.</p> <p>b) Press the Add rotor button.</p> <p>c) Press the column of the desired rotor name and press the Enter button.</p> <p>d) Enter the S/N (Serial number) and press the Enter button.</p>	 <p>a) The Rotor Management screen appears.</p>  <p>b) The ROTOR CATALOG screen appears.</p>  <p>c) The Enter S/N screen appears.</p> <ul style="list-style-type: none"> • Enter a 4-digit number: In the case of "123," prefix zero to the number ("0123").  <p>d) Registration is completed if it is a new rotor having no operation history</p>

Process	Touch panel operation	Screen display and notice
2	<p>Procedures for entering the total operation hours of the rotor are described as follows.</p> <p>a) Press the column of the desired rotor on the Rotor Management screen. Then check that the pressed column turns blue and press the Edit Hours button.</p> <p>b) Enter the total operation hours of the rotor and press the Enter button.</p>	 <p>The screenshots illustrate the following steps:</p> <ol style="list-style-type: none"> The Rotor Management screen displays a table with columns: Name, S/N, Hours, Runs, and Last run. The rotor S150AT is selected, and the Edit Hours button is pressed. The Hours input screen appears, showing a numeric keypad and an Enter button. The Rotor Management screen is updated, showing the rotor S150AT with 1000 hours entered. <ul style="list-style-type: none"> The total operation hours of a rotor having operation history can be registered. This operation is not required for a new rotor.

Process	Touch panel operation	Screen display and notice
3	<p>Procedures for entering the total number of runs of the rotor are described as follows.</p> <p>a) Press the column of the desired rotor on the Rotor Management screen. Then check that the pressed column turns blue and press the Edit Runs button.</p> <p>b) Enter the total number of runs of the rotor and press the Enter button.</p>	 <p>↓</p>  <p>↓</p>  <ul style="list-style-type: none"> • The total number of runs of a rotor having operation history can be registered. This operation is not required for a new rotor.
4	Press the Run screen tab.	<ul style="list-style-type: none"> • The Run screen appears.

(2) Deleting a registered roto

Process	Touch panel operation	Screen display and notice
1	Press the Rotor Management icon on the MENU screen.	 <ul style="list-style-type: none"> The Rotor Management screen appears.
2	Press the column of the rotor which you want to delete on the Rotor Management screen. Then check that the pressed column turns blue and press the Delete rotor button.	 <ul style="list-style-type: none"> The deletion confirmation box is displayed.
3	Press the Yes button on the deletion confirmation box.	 <ul style="list-style-type: none"> The registered rotor is deleted.

Spin-down operation

While you press this button and are holding down it, the micro-ultracentrifuge accelerates up to the set speed at the maximum acceleration rate. When you release this button, it starts deceleration. This feature is useful to remove the adhered samples on the interior walls of the tubes.

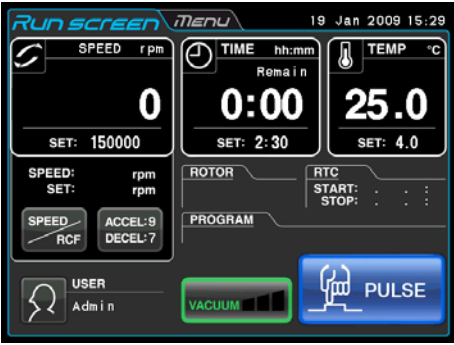

Process	Touch panel operation	Screen display and notice
1	Press the PULSE Operation icon on the MENU screen.	 <ul style="list-style-type: none"> The PULSE button is displayed on the Run screen.
2	While you press the PULSE button and are holding down it, the rotor rotates.	<ul style="list-style-type: none"> When the rotor stops, the PULSE button disappears and the START button and the STOP button appears. To cancel the spin-down operation, press the tab of the MENU screen tab and press the PULSE Operation icon again.

Note 1. While performing the spin-down operation, you cannot change run parameters until the rotor stops

RTC (real-time control) operation

The Sorvall MTX 150 micro-ultracentrifuge contains an internal clock, allowing you to run the machine at a specified start or finish time for centrifugation. This feature for running the machine at a specified time is called the RTC (real-time control) feature. The feature saves you the trouble of calculating the delay time for “delayed-start operation”. Explained below is how to perform an RTC operation, with an example.

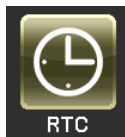

Example: If you wish to install your rotor on the micro-ultracentrifuge under the run conditions listed below on the evening of January 10 and to take out the samples around 8:00 the next morning;

1. Rotor: S150AT
2. RPM: 150,000 rpm
3. Separation time: 2 hours
4. Control temperature: 4°C
5. Acceleration mode: 9
6. Deceleration mode: 7

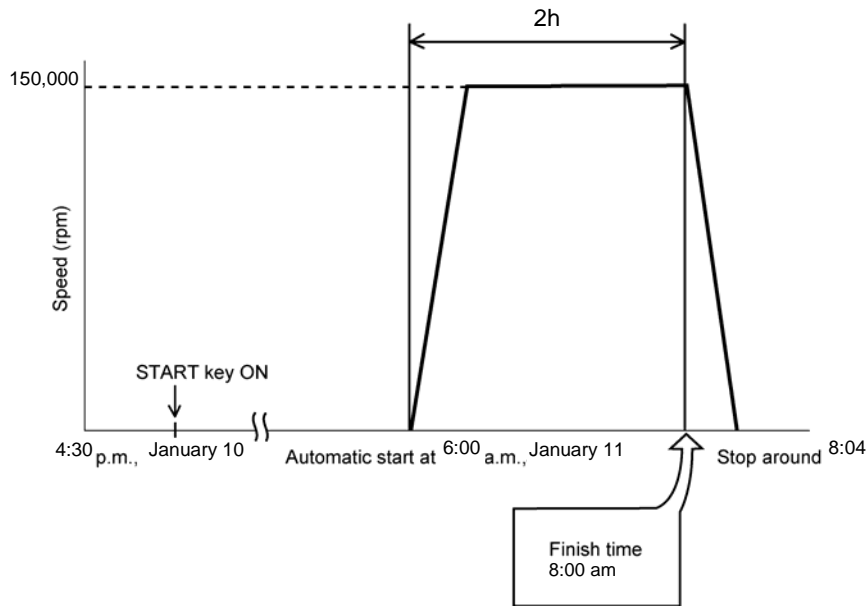
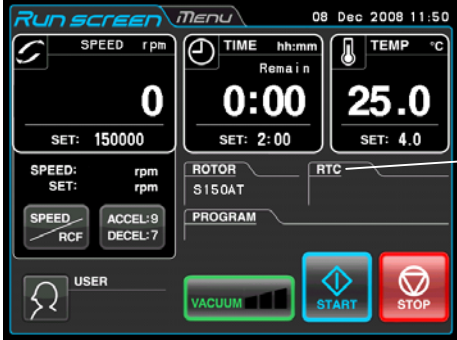



Figure 2-11. A typical RTC operation



In this example, you set the above run conditions (2) through (6), set the start time for RTC operation to 6:00, January 11 and start the micro-ultracentrifuge.

(You can make an identical setting by setting the finish time to 8:00 instead of setting the start time to 6:00.)

1. How to perform RTC an operation

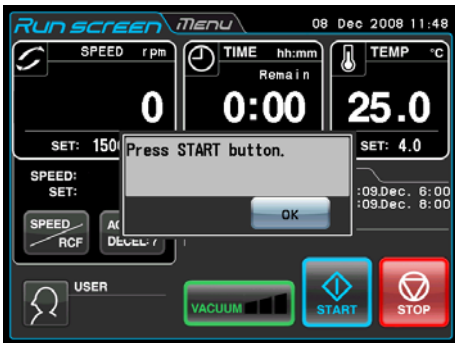
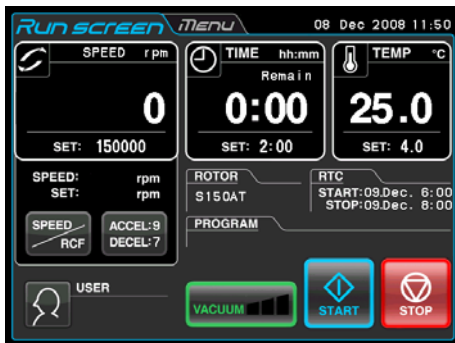
Process	Touch panel operation	Screen display and notice
<p>1</p> <p>Enter the run parameters on the Run screen.</p> <p>Press the RTC button.</p> <p>If you want to set a run to start on a particular date and time, press the Start Time button.</p> <p>If you want to set a run to stop on a particular date and time, press the Stop Time button.</p> <p>Enter the start time or stop time on the keypad display.</p>		 <p>RTC button</p> <ul style="list-style-type: none"> To specify the run time (centrifugation time), do not set HOLD. Enter the desired numeric value. <p>Start time button</p> <p>Stop time button</p>  <ul style="list-style-type: none"> The Set RTC screen appears. You can enter the start time or stop time on the keypad display. If you want to change any of the Month, Day, Hour, or Minutes setting, press the column of the desired item and enter the numeric value. To set the hours, use a number between 0 and 23 (in the 24-hours system). Enter a time later than the current time. When setting the "stop time", allow for centrifugation time and set the centrifugation start time to a time later than the current time. You cannot set the centrifugation start time to a date more than 20 days in the future.

Process	Touch panel operation	Screen display and notice
2	Press the Enter button	 <ul style="list-style-type: none"> The START confirmation box appears.
3	Press the OK button and the START button. The RTC run does not get activated unless you press the START button.	 <ul style="list-style-type: none"> The START time and STOP time for centrifugation are displayed on the RTC field by pressing the START button. This micro-ultracentrifuge will turn the rotor automatically at the specified time. Once the RTC setting is made, you cannot change the run time (centrifugation time). If you wish to make a change to the run time, cancel RTC first. If you want to cancel the RTC, press the RTC button on the Run screen and press the Cancel button on the SET RTC screen. Pressing the START button enters the system into a condition causing the micro-ultracentrifuge to wait until the set time comes. This micro-ultracentrifuge will turn the rotor automatically at the specified time and run it for the specified time.

- You cannot make an RTC setting in any of the following cases:
 - When the Run screen is set to HOLD (continuous run)
 Set the run time (centrifugation time) not to HOLD but to a numerical value.
 - When it is past the start time
 Set the start time to a time later than the current time.
 - When the start time is more than 20 days after the current time
 Set the time to a time no more than 20 days afterwards.
- To change the run time (centrifugation time) after making an RTC setting, cancel RTC and then set a new run time.
- To perform a combination of a programmed operation (including a step-mode operation) with an RTC run, call a program memory unit, then set RTC.
The system calculates the total run times of all steps of the programmed operation and calculates

the start time for RTC.

Therefore, cannot call the program memory unit after setting RTC.

4. To stop this micro-ultracentrifuge in RTC operation, press the STOP button. The system then stops RTC and stops the rotor.

Customizing the settings

You can customize the settings on the Run screen and the settings on the CUSTOM screen such as the stop signal, sound volume and backlight.

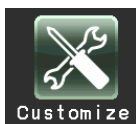

Press the Customize icon on the MENU screen. Then the CUSTOM screen showing the five functions is displayed as shown in Fig. 2-12.

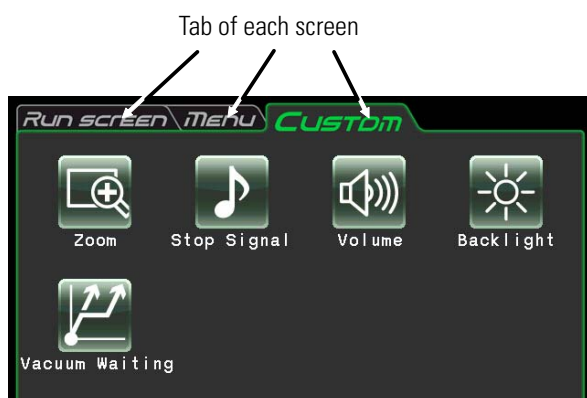







Figure 2-12. CUSTOM screen

The functions of each icon on the CUSTOM screen are described in the table below.

Function	Icon	Description
Zoom		The display on the Run screen can be zoomed in (see “Customizing the settings” on page 2-58 (1)).
Stop signal		The rotor stop signal can be selected from six kinds of sound including five tunes and electric beep (see “Customizing the settings” on page 2-58 (2)).
Volume		The volume of the stop signal can be adjusted (see “Customizing the settings” on page 2-58 (3)).
Brightness		The brightness of the screen can be adjusted (see “Customizing the settings” on page 2-58 (4)).
Vacuum Standby Setting		The conditions of the waiting for the vacuum of the rotor acceleration state can be specified (see “Customizing the settings” on page 2-58 (5)).

Press the desired icon. Then the corresponding item is displayed. After setting, press the tab of the desired screen.

1. Zoom

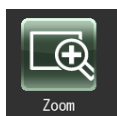

The display on the Run screen can be zoomed in.

1. Normal: Displays the ordinary Run screen
2. Zoom: The speed and time display is zoomed when 20 seconds have passed after reaching the set speed.

- Press either the NORMAL or ZOOM button and make sure that the selected button is surrounded with a green frame.
- Then press the x button or the CUSTOM tab to store the setting.
- To return from the zoom screen to the normal screen during operation, press anywhere except the STOP button. Then the screen returns to the normal screen. Press the Customize icon of the MENU screen and select the NORMAL according to the above procedure.

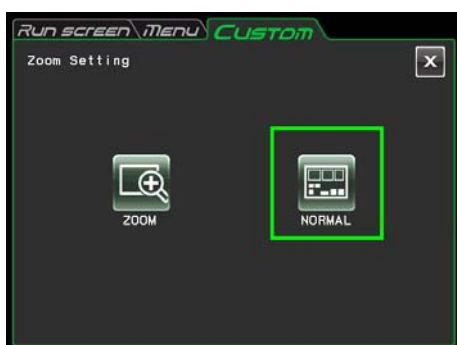

Figure 2-13. Zoom Setting screen

2. Stop signal



The rotor stop signal can be selected from six kinds of sound including five tunes and electric beep.

- Press the column of the desired stop signal. Then the stop signal sounds and the column of the selected stop signal turns blue.
- Press the Enter button to store the setting. To set another function on the CUSTOM screen, press the x button or the CUSTOM tab.

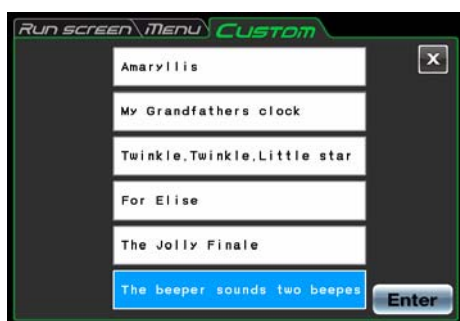

Figure 2-14. Stop signal Setting screen

3. Volume Adjustment



The volume of the stop signal can be adjusted.

- The sound volume is turned up as the green range in the volume setting indicator increases. The stop signal does not sound if there is only the black range. Adjust the sound volume by pressing the following buttons.

- < The volume is lowered by pressing this button.
- > The volume is turned up by pressing this button.



The stop signal does not sound by pressing this button



The stop signal sounds at full volume by pressing this button

- Press the x button or the CUSTOM screen tab to store the setting.

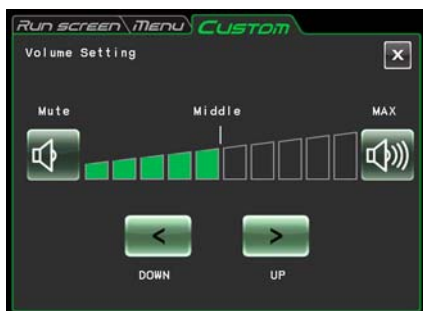

4. Backlight setting



The brightness of the screen can be adjusted.

- The backlight brightens up as the green range in the backlight setting indicator increases. The backlight level is darkest if there is only the black range. Press the following buttons to adjust the brightness of the screen. Press the x button or the CUSTOM screen tab to store the setting.

- < The brightness is decreased by pressing this button.
- > The brightness is increased by pressing this button.



Figure 2-15. Backlight Setting screen

5. Vacuum standby setting



The conditions of the waiting for the vacuum of the rotor acceleration state can be

1. Normal:

When the vacuum level returns from medium to low during acceleration at 5,000 rpm or higher speed, the micro-ultracentrifuge keeps on running at that speed until the vacuum level becomes medium again.

2. No Waiting Acceleration:

The micro-ultracentrifuge keeps on accelerating when it is accelerating at 5,000 rpm or higher speed even after the vacuum level returns from medium to low.

Press either the Normal or No Waiting Acceleration button and make sure that the selected button is surrounded with a green frame. Then press the x button or the CUSTOM screen tab to store the setting.

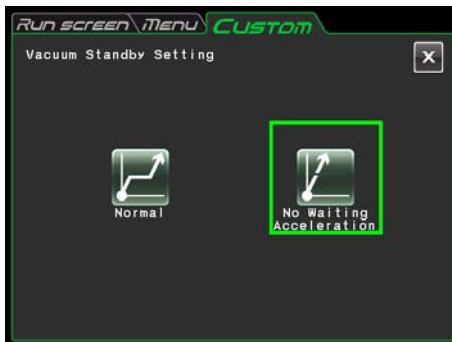
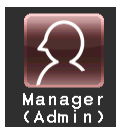

Figure 2-16. Vacuum Standby Setting screen

- Note**
1. Select Normal mode when using the sample that is sensitive to a temperature rise. If you select No Waiting Acceleration, the rotor does not wait until the vacuum reaches an intermediate level and it might cause the rise in the rotor retention temperature by the friction heat.
 2. If the rotor chamber has frost on it by the repeated operation, it takes a long time to reach an intermediate vacuum. In that case, wipe it off with a cloth, a sponge, etc.
 3. Once you select the condition of the waiting for the vacuum (Normal or No Waiting Acceleration), your micro-ultracentrifuge memorizes this condition of the waiting for the vacuum. If necessary, change the condition of the waiting for the vacuum.
 4. If the low vacuum condition persists for more than one minute in the No Waiting Acceleration mode while the rotor rotates at the set speed, the alarm message “VACUUM ERROR” is displayed and the rotor is stopped.

Administrator (Admin) functions



You can set the administrative items such as language mainly.

Press the Manager(Admin) icon on the MENU screen. Then the ADMIN screen showing the eight functions is displayed as shown in Fig. 2-17.

Tab of each screen



Figure 2-17. ADMIN screen

The functions of each icon on the ADMIN screen are described in the table below.

Function	Icon	Description
User Management		The user name can be registered and deleted (see "Administrator (Admin) functions" on page 2-62 (1)).
User Lockout		User login can be required to start operation (see "Administrator (Admin) functions" on page 2-62 (2)).
Rotor Lockout		Run history of each rotor can be controlled (see "Administrator (Admin) functions" on page 2-62 (3)).
Japanese		English and Japanese can be toggled in display (see "Administrator (Admin) functions" on page 2-62 (4)).
Actual Run Timer		Actual run timer can be selected (see "Administrator (Admin) functions" on page 2-62 (5)).
Date and time display		The date and the time can be set (see "Administrator (Admin) functions" on page 2-62 (6)).
Centrifuge ID Service contact		Centrifuge ID can be set for identification (see "Administrator (Admin) functions" on page 2-62 (7)).
USB/LAN communication		The operation history data of the micro-ultracentrifuge can be exported (see "Administrator (Admin) functions" on page 2-62 (8)).



Press the desired icon. Then the corresponding item is displayed. After setting, press the tab of the desired screen.

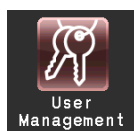



1. User Management





You can register up to 40 users with the system.

How to store (register) and how to change a user name are described below.

Process	Touch panel operation	Screen display and notice
<p>1</p>	<p>Press the User Management icon. Then press the Add User button.</p> <p>("Admin" whose PIN is "1111" has been registered in this micro-ultracentrifuge before shipment. If necessary, change the PIN.)</p>	<div style="display: flex; justify-content: space-between;"> <div style="width: 60%;">  <p data-bbox="686 676 845 705">Add User button</p> </div> <div style="width: 35%;"> <ul style="list-style-type: none"> The User Management appears. </div> </div> <div style="margin-top: 20px;">  <div style="display: flex; justify-content: space-between; margin-top: 10px;"> <div style="width: 45%;"> <p data-bbox="686 1075 845 1108">Clear button</p> <p data-bbox="686 1120 798 1153">Shift button</p> <p data-bbox="893 1075 1037 1108">Space button</p> </div> <div style="width: 45%;"> <p data-bbox="1037 1120 1133 1153">BS button</p> <p data-bbox="1181 1142 1292 1176">Enter button</p> </div> </div> </div> <div style="margin-top: 20px;"> <ul style="list-style-type: none"> A screen to register a user name is displayed. Press the Shift button to toggle case. Press the Clear button to delete all the characters in the user name box. Press the Space button to put one space after the last character in the user name box. Press the BS button to delete the last character in the user name box. Press the Enter button to turn the screen to the PIN registration screen. Press the x button to return to the user administration screen. </div>

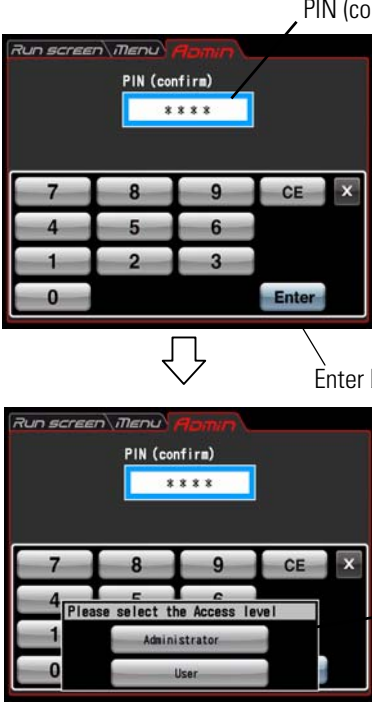
Process	Touch panel operation	Screen display and notice
2	Register the user name and touch the Enter button	 <p data-bbox="1034 611 1155 640">Enter button</p>  <p data-bbox="1007 658 1086 687">PIN box</p> <ul data-bbox="1157 703 1374 763" style="list-style-type: none"> • The PIN registration screen is displayed.
3	Enter the desired PIN number (4 digits) in the PIN box and touch the Enter button.	 <ul data-bbox="1150 1066 1406 1126" style="list-style-type: none"> • The masked PIN number is displayed..  <ul data-bbox="1157 1442 1385 1503" style="list-style-type: none"> • The PIN confirmation screen is displayed.

Process	Touch panel operation	Screen display and notice
4	<p>Enter the same PIN number (4 digits) as the one entered in the above step 3 in the PIN (confirm) box. Press the Enter button.</p> <p>Difference of access level</p> <p>Admin: The administrator can do every operation of this micro-ultracentrifuge.</p> <p>User: The user cannot use the Admin functions when the user lockout function is enabled.</p>	 <ul style="list-style-type: none"> • The masked PIN number is displayed. • The access level selection box is displayed
5	<p>To place the registered user on the same access level with the administrator, press Administrator in the access level selection box. If you do not want to place the registered user on the same access level with the administrator, press User</p> <p>(The screen display shows the case when placing the registered user on the same access level with the administrator.)</p> <p>For the difference of access level, refer to "Administrator (Admin) functions" on page 2-62 (2).</p>	 <ul style="list-style-type: none"> • The screen returns to the User Management screen. "Thermo" is added to the user name and "Administrator" is displayed as the access level. • To change the access level or the PIN number after registration of the user name, press the column of the desired user name and check that the column turns blue. Press the Access level button or the PIN button to make a change. • To delete the user name after registration, press the column of the desired user name and check that the column turns blue. Press the Delete User button to delete it.

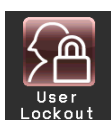

Enable: User login is required to start operation.
The micro-ultracentrifuge does not operate without logging in. Prior user registration is required.

(See “Administrator (Admin) functions” on page 2-62 “User control” and “User login.”)

In addition, login of a user having the administrator access level is required to call up the Admin screen.)

Disable: User login is not required to start operation.



Figure 2-18. User Lockout Setting screen

Press either the Enable or Disable button and make sure that the selected button is surrounded with a red frame.

Then press the x button or the ADMIN screen tab to store the setting.

1. Rotor Lockout



Enable: Select a rotor from the registered rotors to start operation. It is impossible to select from the rotor catalog. (See “Rotor Management” on page 2-49).

Disable: The micro-ultracentrifuge is operable without selecting the rotor. It is possible to select a rotor from the rotor catalog.



Figure 2-19. Rotor Lockout Setting screen

Press either the Enable or Disable button and make sure that the selected button is surrounded with a red frame.

Then press the x button or the ADMIN screen tab to store the setting.

2. Japanese



You can select whether to give displays in English or Japanese by pressing this button.

3. Actual Run Timer setting

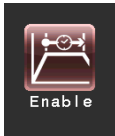

<Actual Run Timer is enabled.>

When you press the Enable button, the timer starts counting after reaching the set speed.

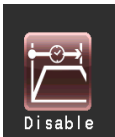

<Actual Run Timer is not enabled.>

When you press the Disable button, the timer starts counting immediately after the start of operation.

Press either the Enable or Disable button and make sure that the selected button is surrounded with a red frame. Then press the x button or the ADMIN screen tab to store the setting.



Figure 2-20. Actual Run Timer Setting screen

4. Date and time

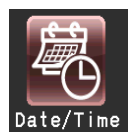

Use this function to precisely set the current time setting of the internal clock. Set an exact date and time for RTC operation.



Figure 2-21. Setting at time screen

Press the column of the desired item (Year, Month, Day, Hour, or Minute). Check that the pressed column turns to red and enter the date and time on the keypad display.
 If you want to change the other items, press the column of the other items.
 You can also turn the desired column to red by pressing the > button and < button.
 If you do not want to change the other items, press the Enter button on the keypad display.

Example:
 Year: 2008
 Month: December
 Day: 11th
 Time: 8:58am



Figure 2-22. Setting at time screen

If you want to change the setting of the other items on the ADMIN screen, press the ADMIN screen tab.

5. ID /Contact

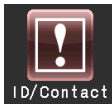

When you have two or more centrifuges, you can set the centrifuge ID for each micro-ultracentrifuge for identification.



Figure 2-23. (1) Centrifuge ID and service contact setting screen

Press the Machine ID column.

Press the Service contact column.



Figure 2-23. (2) Enter Centrifuge ID screen

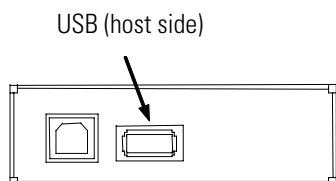

Fig. 2-23. (3) Enter Service contact screen

6. USB/LAN communication



The operation history of the micro-ultracentrifuge can be output in CSV format to a USB memory on the market.



Insert the USB memory on the market into the USB for external connection (host side) at the right side of the micro-ultracentrifuge.



Press the DATA EXPORT button. (Writing in the USB memory is automatically started.)

Figure 2-24. USB/LAN communication setting screen

*CSV format: This is a versatile file format that is compatible with spreadsheet softwares such as EXCEL.

Emergency recovery from power failure



DANGER Before removing the front cover for troubleshooting, always turn off the POWER switch of the instrument, unplug the power cord from the wall outlet, and wait at least three minutes to avoid the risk of electrical shock.



WARNING
 (1) Never open the door during rotation.
 (2) Never touch the rotor during rotation.



CAUTION
 Never conduct operations in a manner other than as described in this operation manual. Contact with your nearest service representative if any problem arises.

1. Rotation of the rotor

The rotor stops as a result of free coast. However, if the rotor did not decelerate to 300 rpm or lower when a power failure occurred, it will, or lower when a power failure occurred, after power returns, automatically accelerate again and return to the set speed before the power failure. If the speed goes below 300 rpm, the rotor will decelerate and stop after power returns.

If the rotor is stopping when the power returns, this micro-ultracentrifuge does not accept the VACUUM button etc. (see “Alarm indicators” on page 4-2).

2. Touchscreen display

All displays are off during a power failure. After power returns, the instrument starts control again at the settings specified before the power failure. (The settings have battery-backed back-ups.) The instrument then displays an alarm message, indicating that it has suffered a power failure.

3. Removing the rotor from the micro-ultracentrifuge

If a power failure may last a long time, open the door and take out the rotor as described below.



WARNING

Before following this procedure, listen carefully for sound from within the rotor chamber and make sure that the rotor is not turning. While the rotor is rotating, never unlock the chamber door.

The rotor chamber is in a vacuum with low air resistance. The rotor may therefore go on turning for approximately 120 minutes before stopping. Allow enough time before opening the door.

1. Make sure that the rotor has stopped.
2. Unplug the power cord of the micro-ultracentrifuge from the wall outlet.
3. Remove the four screws that fasten the both sides of the front cover by Hex key, remove the front cover while pulling it towards you, and remove the cover.

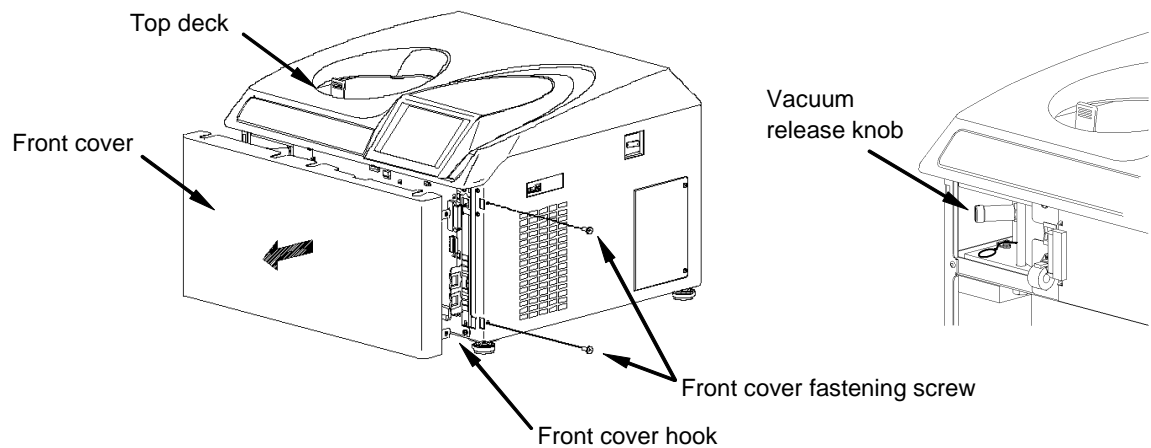

Figure 2-25. Removing the front cover

4. Remove the vacuum release knob at the left of the vacuum chamber (by turning its tip counterclockwise) to allow air to enter the rotor chamber. When the rotor chamber reaches atmospheric pressure, do not forget to return the vacuum release knob to its previous position.
5. Pull the release wire of the door lock in the left side of the vacuum chamber toward you, and open the door. After opening the door, make sure that the rotor is not rotating. If it is rotating, close the door immediately.



WARNING

Never touch the rotor while it is rotating.

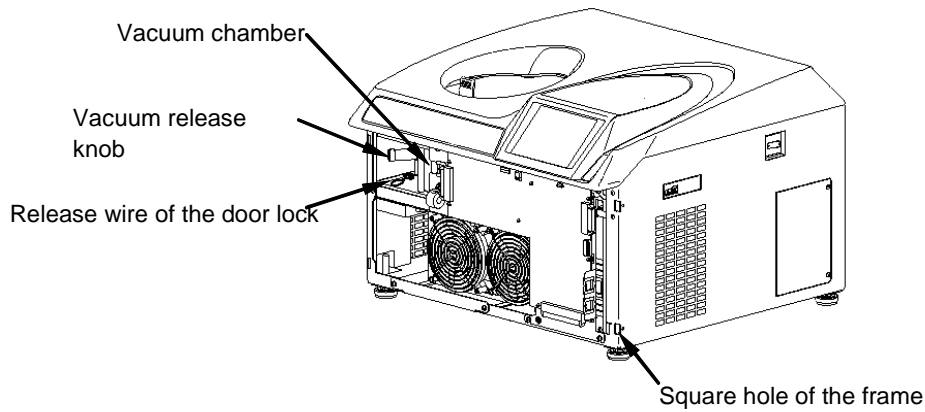

Figure 2-26. Door lock and vacuum release knob

6. After taking out the rotor, insert the hooks (which are on both sides of the front cover) into the frame, and insert the front cover into the gap between the top deck and the front cover supporting plate while holding up the front cover a little. Then fasten them with the fastening screws.

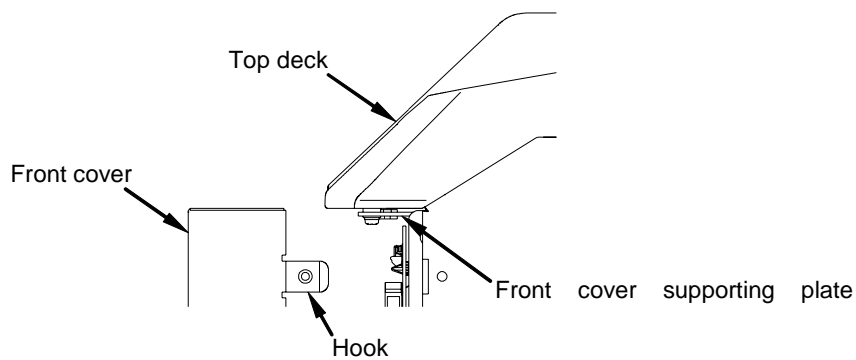

Figure 2-27. Inserting the front cover

7. Plug the power cord into the wall outlet.
8. After the power returns, turn on the power switch of the micro-ultracentrifuge. Press the VACUUM button to turn on the vacuum pump for approximately 15 minutes, and then press the VACUUM button to turn off the vacuum pump. Then turn off the power switch on the micro-ultracentrifuge. (These procedures are effective ways of keeping the vacuum pump in good condition.)

Maintenance

Contents

- “Rotor chamber” on page 3-3
- “Drive shaft (Spindle)” on page 3-3
- “Cabinet” on page 3-3
- “Chamber door seal” on page 3-3
- “Vacuum pump” on page 3-4
- “Others” on page 3-4

Be sure to read and keep in mind the following cautionary information before maintenance.



DANGER Before removing the cover, top deck, or other component for maintenance, always turn off the POWER switch of the instrument, unplug the power cord from the wall outlet, and wait at least three minutes to avoid the risk of electrical shock.

WARNING

(1) If the micro-ultracentrifuge, rotor, or an accessory is contaminated by samples that are toxic or radioactive, or blood samples that are pathogenic or infectious, be sure to decontaminate the item according to good laboratory procedures and methods.

(2) If there is a possibility that the micro-ultracentrifuge, rotor, or an accessory is contaminated by samples that might impair human health (for example, samples that are toxic or radioactive, or blood samples that are pathogenic or infectious), it is your responsibility to sterilize or decontaminate the micro-ultracentrifuge, rotor, or the accessory properly before requesting repairs from a Thermo Fisher Scientific authorized sales/service representative. Note that Thermo Fisher Scientific cannot repair the micro-ultracentrifuge, rotor, or the accessory unless sterilization or decontamination is completed.

(3) It is your responsibility to sterilize and/or decontaminate the micro-ultracentrifuge, rotor, or parts properly before returning them to a Thermo Fisher Scientific authorized sales/service representative. In such cases, copy the decontamination sheet at the end of this manual and fill out the copied sheet, then attach it to the item to be returned.

Thermo Fisher Scientific may ask you about the treatment for the micro-ultracentrifuge, rotor or the part if the decontamination is checked and judged as insufficient by Thermo Fisher Scientific. It is your responsibility to bear the cost of sterilization or decontamination.

Note that Thermo Fisher Scientific cannot repair or inspect the micro-ultracentrifuge, the rotor or the accessory unless sterilization or decontamination is completed.



CAUTION Do not perform any operation not specified in this manual. If any problem is found on your micro-ultracentrifuge, contact a Thermo Fisher Scientific authorized sales/service representative.

This micro-ultracentrifuge does not require complicated maintenance and inspection. For longer and safe use of this micro-ultracentrifuge without trouble, observe the following instructions.



CAUTION Using a cleaning or sterilization method other than the ones recommended in this instruction manual might cause corrosion or deterioration of the micro-ultracentrifuge. Refer to the chemical resistance chart provided with the rotor, or contact Thermo Fisher Scientific.



CAUTION Disconnect the power cord from the outlet before cleaning or sterilizing the micro-ultracentrifuge.

For information on the maintenance of rotors and tubes, see the rotor instruction manual provided with the rotor.

Rotor chamber



CAUTION Do not pour any solution such as water, detergent, or disinfectant directly into the rotor chamber and be careful not to spill the sample into the rotor chamber. If you do so, the bearings of the drive unit might corrode or deteriorate and it might cause vacuum failure.

To maintain the rotor chamber, follow the instructions given below:

1. When the micro-ultracentrifuge is not in use, keep the rotor chamber ventilated.
2. If the bowl is moist, wipe it with a clean, dry cloth or sponge.
3. If the rotor chamber is dirty, wipe it with a clean cloth wrung out in a diluted solution of a mild, non-alkaline detergent. For sterilization, wipe it with a cloth etc. dampened with 70% ethanol.

Drive shaft (Spindle)



CAUTION Clean the inside of the drive hole of the rotor and the surface of the drive shaft of the micro-ultracentrifuge once a month. If the drive hole or the drive shaft is stained or any foreign matter is adhered, the rotor may be improperly installed and come off during operation.

This drive shaft is very important because the rotor is mounted on it and the drive shaft transmits motor torque to the rotor. Before mounting a rotor, wipe the outer surface of the drive shaft with a soft cloth dampened with water.

Cabinet

Always keep the top deck and the cabinet of the micro-ultracentrifuge clean to prevent dust and other materials from falling into the rotor chamber. Wipe the top deck and the cabinet with a cloth or sponge dampened with a diluted solution of neutral detergent. If any solution that is toxic, radioactive, or pathogenic is spilled inside or outside the micro-ultracentrifuge, take necessary action according to your proper laboratory procedures and methods.

Chamber door seal

If the door seal O-ring is dusty or scratched, high vacuum level will not be obtainable. Always keep the door seal O-ring clean. When the micro-ultracentrifuge is used frequently, take out the door seal O-ring and wipe it with a clean, soft cloth and then put a thin coat of vacuum grease on it every three to four months (ordinarily, once a year). If the door seal O-ring is damaged, replace it. Wipe the groove for the door seal O-ring with a clean, soft cloth dampened with alcohol or a similar solvent.

Removing the door seal O-ring

1. While the door is open, turn off the POWER switch and unplug the power cord from the wall outlet.
2. Open the door completely. Then hold the handle of the door and pull up the door.

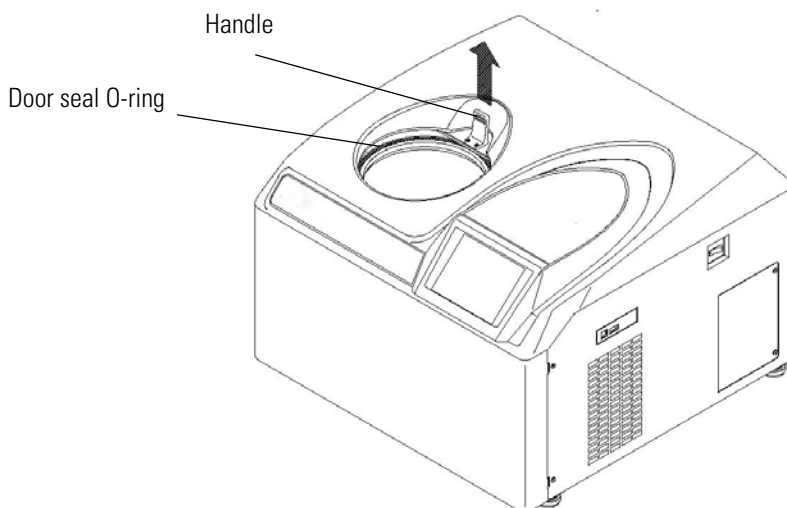

Figure 3-1. Removing the door seal O-ring

3. Use a toothpick etc. to take the door packing out of the groove. At that time, be careful not to damage the door seal O-ring or groove.
4. Clean the door seal O-ring and groove. If the door seal O-ring is damaged, replace it.
5. Apply a thin coat of vacuum grease to the door seal O-ring, insert it into the groove, and close the door.

Vacuum pump

If the VACUUM alarm is displayed frequently, the vacuum pump oil may have deteriorated, the oil mist trap may be clogged or the vacuum pump may have problem. The vacuum pump oil should be changed once a year to prevent deterioration of the vacuum pump and clogging of the oil mist trap. Note that the oil change frequency may differ depending on the use conditions and the environment. Call a service representative when an oil change is required or any trouble occurs.

Oil for the vacuum pump is furnished with this micro-ultracentrifuge. Store it in a safe place and give it to the service representative if requested.

Others

(1) Support period for service parts

Service parts are kept in stock seven years after the discontinuation of production.

The term “service parts” means the parts that are necessary to ensure the correct functioning of the micro-ultracentrifuge.

Troubleshooting

Contents

- “Alarm indicators” on page 4-2
- “User-corrected problem” on page 4-4

Be sure to read and keep in mind the following cautionary information before troubleshooting.



DANGER Before removing the cover, top deck, or other component for troubleshooting, always turn off the POWER switch of the instrument, unplug the power cord from the wall outlet, and wait at least three minutes to avoid the risk of electrical shock.



WARNING

(1) If the micro-ultracentrifuge, rotor, or an accessory is contaminated by samples that are toxic or radioactive, or blood samples that are pathogenic or infectious, be sure to decontaminate the item according to good laboratory procedures and methods.

(2) If there is a possibility that the micro-ultracentrifuge, rotor, or an accessory is contaminated by samples that might impair human health (for example, samples that are toxic or radioactive, or blood samples that are pathogenic or infectious), it is your responsibility to sterilize or decontaminate the micro-ultracentrifuge, rotor, or the accessory properly before requesting repairs from a Thermo Fisher Scientific authorized sales/service representative. Note that Thermo Fisher Scientific cannot repair the micro-ultracentrifuge, rotor, or the accessory unless sterilization or decontamination is completed.

(3) It is your responsibility to sterilize and/or decontaminate the micro-ultracentrifuge, rotor, or parts properly before returning them to a Thermo Fisher Scientific authorized sales/service representative. In such cases, copy the decontamination sheet at the end of this manual and fill out the copied sheet, then attach it to the item to be returned. Thermo Fisher Scientific may ask you about the treatment for the micro-ultracentrifuge, rotor or the part if the decontamination is checked and judged as insufficient by Thermo Fisher Scientific. It is your responsibility to bear the cost of sterilization or decontamination. Note that Thermo Fisher Scientific cannot repair or inspect the micro-ultracentrifuge, the rotor or the accessory unless sterilization or decontamination is completed.



CAUTION Do not perform any operation not specified in this manual. If any problem is found on your micro-ultracentrifuge, contact a Thermo Fisher Scientific authorized sales/service representative.

Before removing the cover, top deck, or other component for troubleshooting, always turn off the POWER switch of the instrument, unplug the power cord from the wall outlet, and wait at least three minutes to avoid the risk of electrical shock.

This micro-ultracentrifuge incorporates a “self-diagnosis feature” that diagnoses the cause of any problem which may occur when you start the micro-ultracentrifuge or while in operation.

Alarm indicators

If any trouble occurs, this machine gives a buzzer sound and displays an alarm message in the message field of the Run screen to warn of the trouble.

1. Responding to an alarm signal

If an alarm message appears, remove the cause of the trouble as described below and press the CE button. You will then be able to resume your centrifugation.



WARNING Unspecified repairs, remodeling or disassembly of the micro-ultracentrifuge that is not listed below is strictly prohibited by any person other than a Thermo Fisher Scientific authorized services representative.

If the alarm message persists even after you have done what is specified below, contact service representative to order a repair.

Alarm	Cause	Action
CLOSE DOOR Close the door completely. Press the VACUUM or START button.	1. The VACUUM or START button has been pressed with the chamber door left open.	Close the door completely and press the VACUUM or START button.
CLOSE DOOR Close the door completely. Press the VACUUM or START button.	1. The VACUUM or START button has been pressed with the chamber door left open.	Close the door completely and press the VACUUM or START button.
VACUUM ERROR Wipe off moisture inside the rotor chamber, or check a sample leakage.	1. Required level of vacuum cannot be reached. 2. After a satisfactorily high level of vacuum was reached, it lowered (due to, for instance, sample leakage).	Wipe off the moisture from inside the rotor chamber. Clean the door packing, then apply a thin coat of vacuum grease. (Refer to "Chamber door seal" on page 3-3) Check if the sample is leaking from the rotor and/or tubes. If so, the tubes may be overfilled or may be cracked or broken. In these cases, reduce the amount of sample in the tubes or change the tubes.
SET ROTOR Set the rotor. Wait up to 20 min. If the alarm is not cleared.	1. The rotor is not installed.	Install the rotor.
IMBALANCE Check balance of samples. Tighten rotor cover or cap securely.	1. Rotor is not properly balanced, and abnormal vibration has occurred in the rotor. 2. Rotor cover or cap is not properly tightened.	Check if the sample tubes exceed allowable imbalance level. Check if any one of the tubes is deformed, and if there is any sign of sample leakage. Tighten rotor cover or cap securely.
INVALID SPEED Check max. speed of the rotor. Set its max. or lower speed again.	1. Rotor speed is set higher than the maximum allowable speed.	Set the speed within their permitted limits.

Alarm	Cause	Action
POWER FAILURE Running re-started automatically or is suspended. Check status.	1. A power failure occurred while the rotor was rotating.	Unless the set run time has elapsed, restart the run. If the instrument was automatically restored and the rotor is rotating at set speed, then let the run continue.
Refer also to “Emergency recovery from power failure” on page 2-70		
POWER FAILURE: ***** rpm Door is closed. Refer to manual for further detail.	1. A power failure occurred while the rotor was rotating and the speed could not be detected after power returned. (This alarm code appears when the detector of this micro-ultracentrifuge could not identify which status (status 1 or status 2) occurred. Status 1: The rotor stopped normally. Status 2: Although the rotor continued to rotate, the speed of the rotor was not detected due to a failure of the speed detector. If this alarm code appears, this micro-ultracentrifuge does not accept the CE or VACUUM button for 120 minutes to ensure safety (The same thing can be said of “E13”).	<ul style="list-style-type: none"> This micro-ultracentrifuge does not accept the CE or VACUUM button for 120 minutes from power failure. If you are convinced that the rotor has come to a complete stop, press the SPEED column, HOLD , 9 , 0 , 1 , HOLD and Enter button in order when the Run screen is displayed. Then press the VACUUM button. This micro-ultracentrifuge accepts the VACUUM button. First open the door a little to confirm that rotor has come to a complete stop. Then open the door properly.
Refer also to “Emergency recovery from power failure” on page 2-70.		
E11-E64	Refer to NOTE.	<ul style="list-style-type: none"> Call a service representative.

Note If a “SET ROTOR” alarm message appears, this micro-ultracentrifuge does not accept the CE or VACUUM button for 20 minutes to ensure safety. Wait at least 20 minutes, then press the CE button.

If any alarm message between E11 and E64 appears, this micro-ultracentrifuge requires maintenance by a service representative. When ordering a repair, inform us of the alarm code you have received.

Note 13 is an alarm code that indicates a failure of the speed detector.
If this alarm code appears, this machine does not accept the CE or VACUUM button for 120 minutes to ensure safety.
These 120 minutes are required for the rotor to stop.
Wait at least 120 minutes before pressing the CE button.
(This “120 minutes” is the time which passed after a power failure occurs.)

User-corrected problem

Some problems are not identified and reported by the self-diagnostic capability of the micro-ultracentrifuge.

To correct these problems, take the action(s) described in the table below.

Symptom	Possible cause	Action
Micro-ultracentrifuge will not start up when its power is on.	<ol style="list-style-type: none"> 1. Building power circuit breaker is open. 2. The power cord is unplugged from the outlet. 	<ul style="list-style-type: none"> • Close the circuit breaker. • Plug the cord into the outlet.
Rotor does not cool, or rotor temperature is rising.	1. Rotor was accelerated at low or intermediate vacuum level.	<ul style="list-style-type: none"> • Start accelerating the rotor when the rotor chamber is at high vacuum level (after the vacuum indicator is displayed as the following).  In a high vacuum
	2. High vacuum level cannot be reached.	<ul style="list-style-type: none"> • Inspect the door seal O-ring (see “Chamber door seal” on page 3-3).
You press the START button, but the rotor will not turn.	1. If the “SET ROTOR” alarm message appears, the overspeed detector may issue a signal that prevents the rotor from rotating even though you pressed the CE button. (This is not a fault.)	<ul style="list-style-type: none"> • Turn off the POWER switch, wait several minutes, turn on the POWER switch again, and press the START button. If this procedure still does not activate this micro-ultracentrifuge, call a service representative.
The backlight level of the screen is too dark or too bright.	1. The brightness of the screen is not adjusted.	<ul style="list-style-type: none"> • Make the adjustment while referring to the clause “Backlight setting” in “Customizing the settings” on page 2-58.
You can not open the door because the STOP button continues to blink.	1. You pressed the START button, and then you pressed the STOP button before the rotor started to rotate.	<ul style="list-style-type: none"> • Because the detector of this micro-ultracentrifuge could not identify which status (status 1 or status 2) occurred, the safety devices function. The micro-ultracentrifuge maintains deceleration status at that time. Status 1: The rotor stops normally. Status 2: The speed detector is faulty. Open the door of the micro-ultracentrifuge after the safety devices are released (after from 10 seconds to approximately four minutes).

Installation

This chapter describes the electrical power requirements, location and environment that you must provide for your micro-ultracentrifuge prior to its installation by an authorized Thermo Fisher Scientific representative.



DANGER Before removing the cover or other component, always turn off the POWER switch of the instrument, unplug the power cord from the wall outlet, and wait at least three minutes to avoid the risk of electrical shock.

Note The installation and leveling of your micro-ultracentrifuge must be done by an authorized Thermo Fisher Scientific representative. If they are done by anyone else, the micro-ultracentrifuge warranty will be null and void.

1. Place of installation

(1) Position the micro-ultracentrifuge on a level surface, such a table or laboratory bench that can support the weight of the micro-ultracentrifuge and resist vibration. (Place the micro-ultracentrifuge at least 5 cm away from the edge of the laboratory bench.)

(2) Ambient temperature for operation is 5 to 35°C. If the room temperature rises above 35°C, the temperature of the rotor may become too high. Avoid installing the micro-ultracentrifuge in direct sunlight.

(3) Keep the back of the instrument at least 8 cm away from the wall. We recommend you install the sides of the instrument about 13cm away from the walls.

Make sure that the air can circulate adequately around this micro-ultracentrifuge. Avoid installing this micro-ultracentrifuge close to a heat-generating device, which might reduce this micro-ultracentrifuge's cooling capacity.



WARNING For operator safety, maintain a 30-cm “clearance envelope” around the instrument and keep out that area while the rotor is spinning. Do not store dangerous substances capable of developing flammable or explosive vapors on nor near the micro-ultracentrifuge.

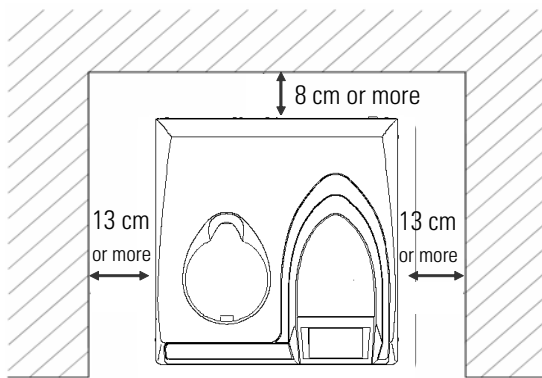

Figure 5-1. Clearance for micro-ultracentrifuge

2. Electrical power requirement



CAUTION Your micro-ultracentrifuge can be damaged if connected to a wrong voltage. Check the voltage before plugging the micro-ultracentrifuge into a power source.



WARNING Your micro-ultracentrifuge must be grounded properly.

An emergency switch (circuit breaker) should be installed that turns off the main power supply in the event of malfunctioning. (The desirable installation location of the emergency switch is outside the room or near the exit.)

Do not position an object so that it is difficult to disconnect the power cord from the outlet. If you do so, you cannot disconnect the power cord from the outlet when you observe some abnormality.

Your micro-ultracentrifuge can operate on one of the following six power voltages:

110 or 120 Vac (50/60 Hz, 15 A)

208, 220, 230, or 240 Vac (50/60 Hz, 8 A)

The voltage requirement for your micro-ultracentrifuge is mentioned on the rectangular marking plate (rating plate) affixed near the power cord connector, which is visible in the rear panel of the micro-ultracentrifuge. Be sure to read the marking plate before plugging the micro-ultracentrifuge.

If the voltage requirement does not match the voltage of the available power source, quit plugging and call your Thermo Fisher Scientific representative.

3. Leveling

(1) Turn the leveling screws with a spanner.

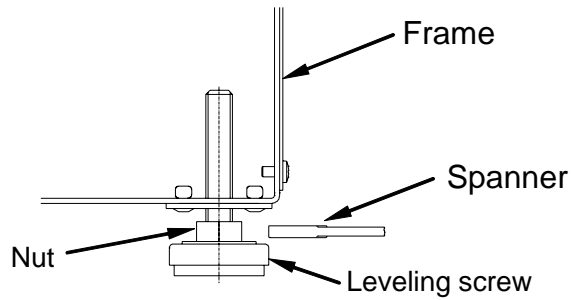

Figure 5-2. Leveling adjustment

(2) Turn on the power to micro-ultracentrifuge, open the chamber door, and then turn off the power. If this micro-ultracentrifuge is still unplugged, refer to “[Emergency recovery from power failure](#)” on [page 2-70](#), remove the front cover, and open the chamber door.

(3) Place the level furnished with this micro-ultracentrifuge on the drive shaft in the rotor chamber and turn the four leveling screws to adjust the levelness of this micro-ultracentrifuge (Fig. 5-3).

(4) After adjusting the levelness, make sure that the four leveling screws are fastened securely to the surface where the micro-ultracentrifuge is positioned.

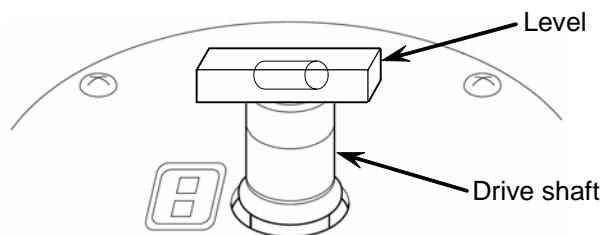

Figure 5-3. Level placement



CAUTION Your micro-ultracentrifuge must be grounded properly. After installation and before any test-run, this micro-ultracentrifuge always needs the internal check by a service representative.

4. Moving the micro-ultracentrifuge

Before moving the micro-ultracentrifuge, disconnect the power cord, and move this micro-ultracentrifuge with the cart. After moving this micro-ultracentrifuge, always install and level it again.



CAUTION Before moving the micro-ultracentrifuge, take the rotor out of the rotor chamber. Pay attention to unevenness or an inclination of the floor, and move the micro-ultracentrifuge so that it is not fallen down. When holding the micro-ultracentrifuge, be careful not to injure your fingers by the screws at the bottom of the micro-ultracentrifuge.

Specifications

Model	Sorvall MTX 150 micro-ultracentrifuge
Maximum speed	150,000 rpm
Maximum RCF*	1,048,680 xg (S140-AT)
Speed control accuracy	±50 rpm (5,000 rpm to maximum speed)
Rotor temperature control/display accuracy	±2°C set temperature is from 0°C to 40°C
Set speed	5,000 rpm to maximum speed in increments of 1,000 rpm
Vacuum system	Oil rotary vacuum pump and oil diffusion pump combined Ultimate vacuum: below 0.6 Pa (0.005 Torr)
Noise level	45 dB (A scale) (measured 1m in front of the instrument)
Maximum heat dissipation into room	0.7 kW or less
Cooling method	Thermo-module cooling (CFC-free)
Screen display and operation	**Color touch-sensitive LCD
Dimensions	Width: 590 mm; Depth: 582 mm; Height: 408 mm
Weight	97 kg
Power requirement***	Single phase: 110 or 120 Vac+/-10%; 50/60 Hz; 15 A 208, 220, 230, or 240 Vac+/-10%; 50/60 Hz; 8 A
Ambient temperature	Ambient temperature for performance: 10 °C to 30 °C Ambient temperature for operation: 5 °C to 35 °C

* RCF is an acronym for relative centrifugal force.

** Please note that the LCD panel may contain a few dead or stuck pixels.

*** The voltage to be used is the one that you specified when purchasing the micro-ultracentrifuge.

The Sorvall MTX 150 micro-ultracentrifuge satisfies CSA and CE marking requirements. The standards are as follows:

- Product safety (EN 61010-1 and EN 61010-2-020)
Environment requirements:
 - indoor use;
 - altitude up to 2000 m;
 - maximum relative humidity 80% for temperatures up to 31 °C decreasing linearly to 50% relative humidity at 40 °C;

Pollution degree	2
Installation category	II







- Electromagnetic compatibility (EN 61326-1, EN 61000-3-2, and EN 61000-3-3)

Table 6-1. List of approved rotors

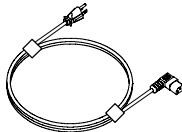
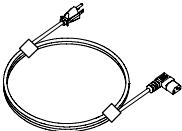
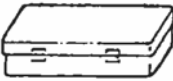
PN	Rotor	Capacity (# places x volume)	Volume ml (nominal)	Max. Speed (rpm)	Max. RCF (x g)	k-factor	R _{min} mm	R _{ave} mm	R _{max} mm	Tube Angle
Fixed Angle Rotors										
45582	S150-AT	8 x 2.0 mL	16 mL	150,000	899,744	6.1	20.8	28.3	35.8	30
45978	S140-AT	10 x 2.0 mL	20 mL	140,000	1,048,684	5.0	32.6	40.3	47.9	35
45584	S120-AT3	14 x 0.5 mL	7 mL	120,000	649,826	7.8	25.9	33.2	40.4	30
45583	S120-AT2	10 x 2.0 mL	20 mL	120,000	649,826	7.8	25.9	33.2	40.4	30
45539	S110-AT	8 x 5.0 mL	40 mL	110,000	690,652	15	24.5	37.8	51.1	30
45588	S100-AT6	8 x 5.0 mL	40 mL	100,000	603,180	18	26.9	40.5	54.0	30
45586	S100-AT4	6 x 3.5 mL	21 mL	100,000	540,628	16	25.8	37.1	48.4	30
45585	S100-AT3	20 x 0.2 mL	4 mL	100,000	435,630	7.0	29.6	34.3	39.0	30
45589	S80-AT2	30 x 0.5 mL	15 mL	80,000	357,440	14	35.5	42.8	50.0	30
45590	S80-AT3	8 x 8.3 mL	66.4 mL	80,000	414,630	23	32.3	45.2	58.0	30
45591	S70-AT	20 x 0.5 mL	10 mL	70,000	307,052	31	31.0	43.6	56.1	30
45866	S58-A	8 x 13.5 mL	108 mL	58,000	288,958	50	39.6	58.3	76.9	35
096-127033	F55-12x1.5 MUC	12 x 1.5 mL	18 mL	55,000	221,575	45	37.6	51.6	65.4	45
45865	S55-A2	12 x 1.5 mL	18 mL	55,000	201,046	40	37.0	48.3	59.5	45
45979	S55-A	8 x 13.5 mL	108 mL	55,000	259,839	56	39.6	58.3	76.9	35
45540	S50-A	6 x 30 mL	180 mL	50,000	209,438	61	41.2	58.1	75.0	35
45592	S45-A	12 x 1.5 mL	18 mL	45,000	124,858	67	32.4	43.8	55.2	45
Swinging Bucket Rotors										
45594	S55-S	4 x 2.2 mL	8.8 mL	55,000	258,826	44	45.4	61.0	76.6	90
45977	S52-ST	4 x 5.0 mL	20 mL	52,000	275,458	79	39.4	65.3	91.2	90
45541	S50-ST	4 x 7.0 mL	28 mL	50,000	252,721	77	42.5	66.5	90.5	90
Vertical Rotors										
45593	S120-VT	8 x 2.0 mL	16 mL	120,000	500,237	7.9	19.9	25.5	31.1	0

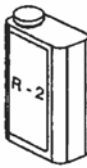
Supply list

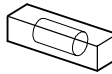
The items below are those supplied with the micro-ultracentrifuge.

Item name	Part No.	Units supplied	Item drawing	Note
Power cord assembly (208-240 V)	S204730	1		2.5m long
Power cord assembly (110-120 V)	S204746	1		2.5m long
Tool box	320717	1		
Hex key	60000122	1		
Vacuum pump oil	S410357	1		Supplied in 2 l container (R-2)
Vacuum grease	65937	1		
Level	45216	1		
Instruction manual	46982	1		

Chemical Compatibility Chart

CHEMICAL	MATERIAL	ALUMINUM	ANODIC COATING for ALUMINUM	BUNA N	CELLULOSE ACETATE BUTYRATE	POLYURETHANE ROTOP PAINT	COMPOSITE Carbon Fiber/Epoxy	DELRIN®	ETHYLENE PROPYLENE	GLASS	NEOPRENE	NORYL®	NYLON	PET®, POLYCLEAR®, CLEARCRIMP®, CCCLEARCRIMP®	POLYALLOMER	POLYCARBONATE	POLYESTER, GLASS THERMOSET	POLYETHERIMIDE	POLYRTHYLENE	POLYPROPYLENE	POLYSULFONE	POLYVINYL CHLORIDE	RULON A®, TEFLON®	SILICONE RUBBER	STAINLESS STEEL	TITANIUM	TYGON®	VITON®
2-mercaptoethanol	S	S	U	-	S	M	S	-	S	U	S	S	U	S	S	-	S	S	S	S	U	S	S	S	S	S	S	S
Acetaldehyde	S	-	U	U	-	-	-	M	-	U	-	-	-	M	U	U	U	M	M	-	M	S	U	-	S	-	U	
Acetone	M	S	U	U	S	U	M	S	S	U	U	S	U	S	U	U	U	S	S	U	U	S	M	M	S	U	U	
Acetonitrile	S	S	U	-	S	M	S	-	S	S	U	S	U	M	U	U	-	S	M	U	U	S	S	S	S	U	U	
Alconox®	U	U	S	-	S	S	S	-	S	S	S	S	S	S	M	S	S	S	S	S	S	S	S	S	S	S	U	
Allyl Alcohol	-	-	-	U	-	-	S	-	-	-	-	S	-	S	S	M	S	S	S	-	M	S	-	-	S	-	-	
Aluminum Chloride	U	U	S	S	S	S	U	S	S	S	S	M	S	S	S	S	-	S	S	S	S	S	M	U	U	S	S	
Formic Acid (100%)	-	S	M	U	-	-	U	-	-	-	-	U	-	S	M	U	U	S	S	-	U	S	-	U	S	-	U	
Ammonium Acetate	S	S	U	-	S	S	S	-	S	S	S	S	S	S	S	U	-	S	S	S	S	S	S	S	S	S	S	S
Ammonium Carbonate	M	S	U	S	S	S	S	S	S	S	S	S	S	S	U	U	-	S	S	S	S	S	S	M	S	S	S	
Ammonium Hydroxide (10%)	U	U	S	U	S	S	M	S	S	S	S	S	-	S	U	M	S	S	S	S	S	S	S	S	S	M	S	
Ammonium Hydroxide (28%)	U	U	S	U	S	U	M	S	S	S	S	S	U	S	U	M	S	S	S	S	S	S	S	S	S	M	S	
Ammonium Hydroxide (conc.)	U	U	U	U	S	U	M	S	-	S	-	S	U	S	U	U	S	S	S	-	M	S	S	S	S	-	U	
Ammonium Phosphate	U	-	S	-	S	S	S	S	S	S	S	S	-	S	S	M	-	S	S	S	S	S	S	M	S	S	S	
Ammonium Sulfate	U	M	S	-	S	S	U	S	S	S	S	S	S	S	S	S	-	S	S	S	S	S	S	U	S	S	U	
Amyl Alcohol	S	-	M	U	-	-	S	S	-	M	-	S	-	M	S	S	S	S	M	-	-	-	U	-	S	-	M	
Aniline	S	S	U	U	U	U	S	M	S	U	U	U	U	U	U	U	-	S	M	U	U	S	S	S	S	U	S	
Sodium Hydroxide (<1%)	U	-	M	S	S	S	-	-	S	M	S	S	-	S	M	M	S	S	S	S	S	S	M	S	S	-	U	
Sodium Hydroxide (10%)	U	-	M	U	-	-	U	-	M	M	S	S	U	S	U	U	S	S	S	S	S	S	M	S	S	-	U	
Barium Salts	M	U	S	-	S	S	S	S	S	S	S	S	S	S	S	M	-	S	S	S	S	S	M	S	S	S	S	
Benzene	S	S	U	U	S	U	M	U	S	U	U	S	U	U	U	M	U	M	U	U	U	S	U	U	S	U	S	
Benzyl Alcohol	S	-	U	U	-	-	M	M	-	M	-	S	U	U	U	U	U	U	U	-	M	S	M	-	S	-	S	
Boric Acid	U	S	S	M	S	S	U	S	S	S	S	S	S	S	S	S	U	S	S	S	S	S	S	S	S	S	S	
Cesium Acetate	M	-	S	-	S	S	S	-	S	S	S	S	-	S	S	-	-	S	S	S	S	S	M	S	S	S	S	

A Chemical Compatibility Chart

CHEMICAL	MATERIAL																											
	ALUMINUM	ANODIC COATING for ALUMINUM	BUNA N	CELLULOSE ACETATE BUTYRATE	POLYURETHANE ROTOR PAINT	COMPOSITE Carbon Fiber/Epoxy	DELRIN®	ETHYLENE PROPYLENE	GLASS	NEOPRENE	NORYL®	NYLON	PET®, POLYCLEAR®, CLEARCRIMP®, CCCLEARCRIMP®	POLYALLUMER	POLYCARBONATE	POLYESTER, GLASS THERMOSET	POLYETHERIMIDE	POLYRTHYLENE	POLYPROPYLENE	POLYSULFONE	POLYVINYL CHLORIDE	RULON A®, TEFLON®	SILICONE RUBBER	STAINLESS STEEL	TITANIUM	TYGON®	VITON®	
Cesium Bromide	M	S	S	-	S	S	S	-	S	S	S	S	S	S	S	-	-	S	S	S	S	S	S	M	S	S	S	
Cesium Chloride	M	S	S	U	S	S	S	-	S	S	S	S	S	S	S	-	-	S	S	S	S	S	S	M	S	S	S	
Cesium Formate	M	S	S	-	S	S	S	-	S	S	S	S	S	S	S	-	-	S	S	S	S	S	S	M	S	S	S	
Cesium Iodide	M	S	S	-	S	S	S	-	S	S	S	S	S	S	S	-	-	S	S	S	S	S	S	M	S	S	S	
Cesium Sulfate	M	S	S	-	S	S	S	-	S	S	S	S	S	S	S	-	-	S	S	S	S	S	S	M	S	S	S	
Chloroform	U	U	U	U	S	S	M	U	S	U	U	M	U	M	U	U	U	M	M	U	U	S	U	U	U	M	S	
Chromic Acid (10%)	U	-	U	U	S	U	U	-	S	S	S	U	S	S	M	U	M	S	S	U	M	S	M	U	S	S	S	
Chromic Acid (50%)	U	-	U	U	-	U	U	-	-	-	S	U	U	S	M	U	M	S	S	U	M	S	-	U	M	-	S	
Cresol Mixture	S	S	U	-	-	-	S	-	S	U	U	U	U	U	U	-	-	U	U	-	U	S	S	S	S	U	S	
Cyclohexane	S	S	S	-	S	S	S	U	S	U	S	S	U	U	U	M	S	M	U	M	M	S	U	M	M	U	S	
Deoxycholate	S	S	S	-	S	S	S	-	S	S	S	S	S	S	S	-	-	S	S	S	S	S	S	S	S	S	S	
Distilled Water	S	S	S	S	S	S	S	S	S	S	S	S	S	S	S	S	S	S	S	S	S	S	S	S	S	S	S	
Dextran	M	S	S	S	S	S	S	-	S	S	S	S	S	S	S	S	S	S	S	S	S	S	S	M	S	S	S	
Diethyl Ether	S	S	U	U	S	S	S	U	S	U	U	S	U	U	U	U	U	U	U	U	U	S	S	S	S	M	U	
Diethyl Ketone	S	-	U	U	-	-	M	-	S	U	-	S	-	M	U	U	U	M	M	-	U	S	-	-	S	U	U	
Diethylpyrocarbonate	S	S	U	-	S	S	S	-	S	S	U	S	U	S	U	-	-	S	S	S	M	S	S	S	S	S	S	
Dimethylsulfoxide	S	S	U	U	S	S	S	-	S	U	S	S	U	S	U	U	-	S	S	U	U	S	S	S	S	U	U	
Dioxane	M	S	U	U	S	S	M	M	S	U	U	S	U	M	U	U	-	M	M	M	U	S	S	S	S	U	U	
Ferric Chloride	U	U	S	-	-	-	M	S	-	M	-	S	-	S	-	-	-	S	S	-	-	-	M	U	S	-	S	
Acetic Acid (Glacial)	S	S	U	U	S	S	U	M	S	U	S	U	U	U	U	U	M	S	U	M	U	S	U	U	S	-	U	
Acetic Acid (5%)	S	S	M	S	S	S	M	S	S	S	S	S	M	S	S	S	S	S	S	M	S	S	M	S	S	S	M	
Acetic Acid (60%)	S	S	U	U	S	S	U	-	S	M	S	U	U	M	U	S	M	S	M	S	M	S	M	U	S	M	U	
Ethyl Acetate	M	M	U	U	S	S	M	M	S	S	U	S	U	M	U	U	-	S	S	U	U	S	M	M	S	U	U	
Ethyl Alcohol (50%)	S	S	S	S	S	S	M	S	S	S	S	S	U	S	U	S	S	S	S	S	S	S	S	M	S	M	U	
Ethyl Alcohol (95%)	S	S	S	U	S	S	M	S	S	S	S	S	U	S	U	-	S	S	S	M	S	S	S	U	S	M	U	
Ethylene Dichloride	S	-	U	U	-	-	S	M	-	U	U	S	U	U	U	U	U	U	U	-	U	S	U	-	S	-	S	
Ethylene Glycol	S	S	S	S	S	S	S	S	S	S	S	S	-	S	U	S	S	S	S	S	S	S	S	M	S	M	S	
Ethylene Oxide Vapor	S	-	U	-	-	U	-	-	S	U	-	S	-	S	M	-	-	S	S	S	U	S	U	S	S	S	U	
Ficoll-Hypaque®	M	S	S	-	S	S	S	-	S	S	S	S	-	S	S	-	S	S	S	S	S	S	S	M	S	S	S	
Hydrofluoric Acid (10%)	U	U	U	M	-	-	U	-	-	U	U	S	-	S	M	U	S	S	S	S	M	S	U	U	U	-	-	
Hydrofluoric Acid (50%)	U	U	U	U	-	-	U	-	-	U	U	U	U	S	U	U	U	S	S	M	M	S	U	U	U	-	M	

CHEMICAL	MATERIAL	ALUMINUM	ANODIC COATING for ALUMINUM	BUNA N	CELLULOSE ACETATE BUTYRATE	POLYURETHANE ROTOR PAINT	COMPOSITE Carbon Fiber/Epoxy	DELRIN®	ETHYLENE PROPYLENE	GLASS	NEOPRENE	NORYL®	NYLON	PET®, POLYCLEAR®, CLEARCRIMP®, CCCLEARCRIMP®	POLYALLOMER	POLYCARBONATE	POLYESTER, GLASS THERMOSET	POLYETHERIMIDE	POLYRTHYLENE	POLYPROPYLENE	POLYSULFONE	POLYVINYL CHLORIDE	RULON A®, TEFLON®	SILICONE RUBBER	STAINLESS STEEL	TITANIUM	TYGON®	VITON®
Hydrochloric Acid (conc.)	U	U	U	U	-	U	U	M	-	U	M	U	U	M	U	U	U	-	S	-	U	S	U	U	U	-	-	
Formaldehyde (40%)	M	M	M	S	S	S	S	M	S	S	S	S	M	S	S	S	U	S	S	M	S	S	S	M	S	M	U	
Glutaraldehyde	S	S	S	S	-	-	S	-	S	S	S	S	S	S	S	-	-	S	S	S	-	-	S	S	S	-	-	
Glycerol	M	S	S	-	S	S	S	S	S	S	S	S	S	S	S	S	-	S	S	S	S	S	S	S	S	S	S	
Guanidine Hydrochloride	U	U	S	-	S	S	S	-	S	S	S	S	S	S	S	-	-	S	S	S	S	S	S	U	S	S	S	
Haemo-Sol®	S	S	S	-	-	-	S	-	S	S	S	S	S	S	S	-	-	S	S	S	S	S	S	S	S	S	S	
Hexane	S	S	S	-	S	S	S	-	S	S	U	S	U	M	U	S	S	U	S	S	M	S	U	S	S	U	S	
Isobutyl Alcohol	-	-	M	U	-	-	S	S	-	U	-	S	U	S	S	M	S	S	S	-	S	S	S	-	S	-	S	
Isopropyl Alcohol	M	M	M	U	S	S	S	S	S	U	S	S	U	S	U	M	S	S	S	S	S	S	S	M	M	M	S	
Iodoacetic Acid	S	S	M	-	S	S	S	-	S	M	S	S	M	S	S	-	M	S	S	S	S	S	M	S	S	M	M	
Potassium Bromide	U	S	S	-	S	S	S	-	S	S	S	S	S	S	S	S	S	S	S	S	-	S	S	M	S	S	S	
Potassium Carbonate	M	U	S	S	S	S	S	-	S	S	S	S	S	S	U	S	S	S	S	S	S	S	S	S	S	S	S	
Potassium Chloride	U	S	S	-	S	S	S	S	S	S	S	S	S	S	S	-	S	S	S	S	S	S	S	U	S	S	S	
Potassium Hydroxide (5%)	U	U	S	S	S	S	M	-	S	S	S	S	-	S	U	S	S	S	S	S	S	S	M	U	M	S	U	
Potassium Hydroxide (conc.)	U	U	M	U	-	-	M	-	M	S	S	-	U	M	U	U	U	S	M	-	M	U	-	U	U	-	U	
Potassium Permanganate	S	S	S	-	S	S	S	-	S	S	S	U	S	S	S	M	-	S	M	S	U	S	S	M	S	U	S	
Calcium Chloride	M	U	S	S	S	S	S	S	S	S	S	S	S	S	M	S	-	S	S	S	S	S	M	S	S	S	S	
Calcium Hypochlorite	M	-	U	-	S	M	M	S	-	M	-	S	-	S	M	S	-	S	S	S	M	S	M	U	S	-	S	
Kerosene	S	S	S	-	S	S	S	U	S	M	U	S	U	M	M	S	-	M	M	M	S	S	U	S	S	U	S	
Sodium Chloride (10%)	S	-	S	S	S	S	S	S	-	-	-	S	S	S	S	S	-	S	S	S	S	-	S	S	M	-	S	
Sodium Chloride (sat'd)	U	-	S	U	S	S	S	-	-	-	-	S	S	S	S	S	-	S	S	-	S	-	S	S	M	-	S	
Carbon Tetrachloride	U	U	M	S	S	U	M	U	S	U	U	S	U	M	U	S	S	M	M	S	M	M	M	M	U	S	S	
Aqua Regia	U	-	U	U	-	-	U	-	-	-	-	-	U	U	U	U	U	U	U	-	-	-	-	-	S	-	M	
Solution 555 (20%)	S	S	S	-	-	-	S	-	S	S	S	S	S	S	S	-	-	S	S	S	-	S	S	S	S	S	S	
Magnesium Chloride	M	S	S	-	S	S	S	S	S	S	S	S	S	S	S	S	S	S	S	S	S	S	S	M	S	S	S	
Mercaptoacetic Acid	U	S	U	-	S	M	S	-	S	M	S	U	U	U	U	-	S	U	U	S	M	S	U	S	S	S	S	
Methyl Alcohol	S	S	S	U	S	S	M	S	S	S	S	S	U	S	U	M	S	S	S	S	S	S	S	M	S	M	U	
Methylene Chloride	U	U	U	U	M	S	S	U	S	U	U	S	U	U	U	U	U	M	U	U	U	S	S	M	U	S	U	
Methyl Ethyl Ketone	S	S	U	U	S	S	M	S	S	U	U	S	U	S	U	U	U	S	S	U	U	S	S	S	S	U	U	
Metrizamide®	M	S	S	-	S	S	S	-	S	S	S	S	-	S	S	-	-	S	S	S	S	S	S	M	S	S	S	
Lactic Acid (100%)	-	-	S	-	-	-	-	-	-	M	S	U	-	S	S	S	M	S	S	-	M	S	M	S	S	-	S	

A Chemical Compatibility Chart

CHEMICAL	MATERIAL																										
	ALUMINUM	ANODIC COATING for ALUMINUM	BUNA N	CELLULOSE ACETATE BUTYRATE	POLYURETHANE ROTOR PAINT	COMPOSITE Carbon Fiber/Epoxy	DELRIN®	ETHYLENE PROPYLENE	GLASS	NEOPRENE	NORYL®	NYLON	PET*, POLYCLEAR®, CLEARCRIMP®, CCCLEARCRIMP®	POLYALLOMER	POLYCARBONATE	POLYESTER, GLASS THERMOSET	POLYETHERIMIDE	POLYRTHYLENE	POLYPROPYLENE	POLYSULFONE	POLYVINYL CHLORIDE	RULON A®, TEFLON®	SILICONE RUBBER	STAINLESS STEEL	TITANIUM	TYGON®	VITON®
Lactic Acid (20%)	-	-	S	S	-	-	-	-	-	M	S	M	-	S	S	S	S	S	S	S	M	S	M	S	S	-	S
N-Butyl Alcohol	S	-	S	U	-	-	S	-	-	S	M	-	U	S	M	S	S	S	S	M	M	S	M	-	S	-	S
N-Butyl Phthalate	S	S	U	-	S	S	S	-	S	U	U	S	U	U	U	M	-	U	U	S	U	S	M	M	S	U	S
N, N-Dimethylformamide	S	S	S	U	S	M	S	-	S	S	U	S	U	S	U	U	-	S	S	U	U	S	M	S	S	S	U
Sodium Borate	M	S	S	S	S	S	S	S	S	S	S	U	S	S	S	S	-	S	S	S	S	S	S	M	S	S	S
Sodium Bromide	U	S	S	-	S	S	S	-	S	S	S	S	S	S	S	S	-	S	S	S	S	S	S	M	S	S	S
Sodium Carbonate (2%)	M	U	S	S	S	S	S	S	S	S	S	S	S	S	U	S	S	S	S	S	S	S	S	S	S	S	S
Sodium Dodecyl Sulfate	S	S	S	-	S	S	S	-	S	S	S	S	S	S	S	-	S	S	S	S	S	S	S	S	S	S	S
Sodium Hypochlorite (5%)	U	U	M	S	S	M	U	S	S	M	S	S	S	M	S	S	S	S	M	S	S	S	M	U	S	M	S
Sodium Iodide	M	S	S	-	S	S	S	-	S	S	S	S	S	S	S	-	-	S	S	S	S	S	S	M	S	S	S
Sodium Nitrate	S	S	S	-	S	S	S	S	S	S	S	S	S	S	S	S	-	S	S	S	S	S	U	S	S	S	S
Sodium Sulfate	U	S	S	-	S	S	S	S	S	S	S	S	S	S	S	S	S	S	S	S	S	S	S	M	S	S	S
Sodium Sulfide	S	-	S	S	-	-	-	S	-	-	-	S	S	S	U	U	-	-	S	-	-	-	S	S	M	-	S
Sodium Sulfite	S	S	S	-	S	S	S	S	M	S	S	S	S	S	S	M	-	S	S	S	S	S	S	S	S	S	S
Nickel Salts	U	S	S	S	S	S	-	S	S	S	-	-	S	S	S	S	-	S	S	S	S	S	M	S	S	S	S
Oils (Petroleum)	S	S	S	-	-	-	S	U	S	S	S	S	U	U	M	S	M	U	U	S	S	S	U	S	S	S	S
Oils (Other)	S	-	S	-	-	-	S	M	S	S	S	S	U	S	S	S	S	U	S	S	S	S	-	S	S	M	S
Oleic Acid	S	-	U	S	S	S	U	U	S	U	S	S	M	S	S	S	S	S	S	S	S	S	M	U	S	M	M
Oxalic Acid	U	U	M	S	S	S	U	S	S	S	S	S	U	S	U	S	S	S	S	S	S	S	U	M	S	S	S
Perchloric Acid (10%)	U	-	U	-	S	U	U	-	S	M	M	-	-	M	U	M	S	M	M	-	M	S	U	-	S	-	S
Perchloric Acid (70%)	U	U	U	-	-	U	U	-	S	U	M	U	U	M	U	U	U	M	M	U	M	S	U	U	S	U	S
Phenol (5%)	U	S	U	-	S	M	M	-	S	U	M	U	U	S	U	M	S	M	S	U	U	S	U	M	M	M	S
Phenol (50%)	U	S	U	-	S	U	M	-	S	U	M	U	U	U	U	U	S	U	M	U	U	S	U	U	U	M	S
Phosphoric Acid (10%)	U	U	M	S	S	S	U	S	S	S	S	U	-	S	S	S	S	S	S	S	S	S	U	M	U	S	S
Phosphoric Acid (conc.)	U	U	M	M	-	-	U	S	-	M	S	U	U	M	M	S	S	S	M	S	M	S	U	M	U	-	S
Physiologic Media (Serum, Urine)	M	S	S	S	-	-	S	-	S	S	S	S	S	S	S	S	S	S	S	S	S	S	S	S	S	S	S
Picric Acid	S	S	U	-	S	M	S	S	S	M	S	U	S	S	S	U	S	S	S	S	U	S	U	M	S	M	S
Pyridine (50%)	U	S	U	U	S	U	U	-	U	S	S	U	U	M	U	U	-	U	S	M	U	S	S	U	U	U	U
Rubidium Bromide	M	S	S	-	S	S	S	-	S	S	S	S	S	S	S	-	-	S	S	S	S	S	M	S	S	S	S
Rubidium Chloride	M	S	S	-	S	S	S	-	S	S	S	S	S	S	S	-	-	S	S	S	S	S	M	S	S	S	S
Sucrose	M	S	S	-	S	S	S	S	S	S	S	S	S	S	S	S	S	S	S	S	S	S	S	S	S	S	S

CHEMICAL	MATERIAL																											
	ALUMINUM	ANODIC COATING for ALUMINUM	BUNA N	CELLULOSE ACETATE BUTYRATE	POLYURETHANE ROTOR PAINT	COMPOSITE Carbon Fiber/Epoxy	DELRIN®	ETHYLENE PROPYLENE	GLASS	NEOPRENE	NORYL®	NYLON	PET®, POLYCLEAR®, CLEARCRIMP®, CCCLEARCRIMP®	POLYALLOMER	POLYCARBONATE	POLYESTER, GLASS THERMOSET	POLYETHERIMIDE	POLYRTHYLENE	POLYPROPYLENE	POLYSULFONE	POLYVINYL CHLORIDE	RULON A®, TEFLON®	SILICONE RUBBER	STAINLESS STEEL	TITANIUM	TYGON®	VITON®	
Sucrose, Alkaline	M	S	S	-	S	S	S	-	S	S	S	S	S	S	U	S	S	S	S	S	S	S	S	M	S	S	S	
Sulfosalicylic Acid	U	U	S	S	S	S	S	-	S	S	S	U	S	S	S	-	S	S	S	-	S	S	S	U	S	S	S	
Nitric Acid (10%)	U	S	U	S	S	U	U	-	S	U	S	U	-	S	S	S	S	S	S	S	S	S	M	S	S	S	S	
Nitric Acid (50%)	U	S	U	M	S	U	U	-	S	U	S	U	U	M	M	U	M	M	M	S	S	S	U	S	S	M	S	
Nitric Acid (95%)	U	-	U	U	-	U	U	-	-	U	U	U	U	M	U	U	U	U	M	U	U	S	U	S	S	-	S	
Hydrochloric Acid (10%)	U	U	M	S	S	S	U	-	S	S	S	U	U	S	U	S	S	S	S	S	S	S	S	U	M	S	S	
Hydrochloric Acid (50%)	U	U	U	U	S	U	U	-	S	M	S	U	U	M	U	U	S	S	S	S	M	S	M	U	U	M	M	
Sulfuric Acid (10%)	M	U	U	S	S	U	U	-	S	S	M	U	S	S	S	S	S	S	S	S	S	S	U	U	U	S	S	
Sulfuric Acid (50%)	M	U	U	U	S	U	U	-	S	S	M	U	U	S	U	U	M	S	S	S	S	S	U	U	U	M	S	
Sulfuric Acid (conc.)	M	U	U	U	-	U	U	M	-	-	M	U	U	S	U	U	U	M	S	U	M	S	U	U	U	-	S	
Stearic Acid	S	-	S	-	-	-	S	M	S	S	S	S	-	S	S	S	S	S	S	S	S	S	M	M	S	S	S	
Tetrahydrofuran	S	S	U	U	S	U	U	M	S	U	U	S	U	U	U	-	M	U	U	U	U	S	U	S	S	U	U	
Toluene	S	S	U	U	S	S	M	U	S	U	U	S	U	U	U	S	U	M	U	U	U	S	U	S	U	U	M	
Trichloroacetic Acid	U	U	U	-	S	S	U	M	S	U	S	U	U	S	M	-	M	S	S	U	U	S	U	U	U	M	U	
Trichloroethane	S	-	U	-	-	-	M	U	-	U	-	S	U	U	U	U	U	U	U	U	U	S	U	-	S	-	S	
Trichloroethylene	-	-	U	U	-	-	-	U	-	U	-	S	U	U	U	U	U	U	U	U	U	S	U	-	U	-	S	
Trisodium Phosphate	-	-	-	S	-	-	M	-	-	-	-	-	-	S	-	-	S	S	S	-	-	S	-	-	S	-	S	
Tris Buffer (neutral pH)	U	S	S	S	S	S	S	-	S	S	S	S	S	S	S	S	S	S	S	S	S	S	S	S	S	S	S	
Triton X-100®	S	S	S	-	S	S	S	-	S	S	S	S	S	S	S	S	S	S	S	S	S	S	S	S	S	S	S	
Urea	S	-	U	S	S	S	S	-	-	-	-	S	S	S	M	S	S	S	S	-	S	S	S	M	S	-	S	
Hydrogen Peroxide (10%)	U	U	M	S	S	U	U	-	S	S	S	U	S	S	S	M	U	S	S	S	S	S	S	M	S	U	S	
Hydrogen Peroxide (3%)	S	M	S	S	S	-	S	-	S	S	S	S	S	S	S	S	M	S	S	S	S	S	S	S	S	S	S	
Xylene	S	S	U	S	S	S	M	U	S	U	U	U	U	U	U	M	U	M	U	U	U	S	U	M	S	U	S	
Zinc Chloride	U	U	S	S	S	S	U	S	S	S	S	S	S	S	S	S	S	S	S	S	S	S	S	U	S	S	S	
Zinc Sulfate	U	S	S	-	S	S	S	S	S	S	S	S	S	S	S	S	S	S	S	S	S	S	S	S	S	S	S	
Citric Acid (10%)	M	S	S	M	S	S	M	S	S	S	S	S	S	S	S	S	M	S	S	S	S	S	S	S	S	S	S	

Polyethyleneterephthalate

A Chemical Compatibility Chart

Key

- S Satisfactory
- M M = Moderate attack, may be satisfactory for use in centrifuge depending on length of exposure, speed involved, etc.; suggest testing under actual conditions of use.
- U U = Unsatisfactory, not recommended.
- Performance unknown; suggest testing, using sample to avoid loss of valuable material.

Chemical resistance data is included only as a guide to product use. Because no organized chemical resistance data exists for materials under the stress of centrifugation, when in doubt we recommend pretesting sample lots.

Warranty

Thermo Fisher Scientific warrants that the Products will operate substantially in conformity with Thermo Fisher Scientific published specifications, when subjected to normal, proper and intended usage by properly trained personnel, for a period of 12 MONTHS after shipment to the Customer (the “Warranty Period”). In addition, the drive is warranted for 5 years after shipment to the Customer. Thermo Fisher Scientific agrees during the Warranty Period, provided it is promptly notified in writing upon the discovery of any material defect and further provided that all costs of returning the defective Goods to the Thermo Fisher Scientific are pre-paid by the Customer, to repair or replace, at Thermo Fisher Scientific’s option, defective Goods so as to cause the same to operate in substantial conformance with the said specifications. Replacement parts may be new or refurbished, at the election of Thermo Fisher Scientific. All replaced parts shall become the property of Thermo Fisher Scientific. All consumable or expendable items are expressly excluded from the warranty under this Clause. Thermo Fisher Scientific’s sole liability with respect to equipment, materials, parts or software furnished to Thermo Fisher Scientific by its third party suppliers shall be limited to the assignment by Thermo Fisher Scientific to the Customer of any such third party supplier’s warranty, to the extent the same is assignable. In no event shall Thermo Fisher Scientific have any obligation to make repairs, replacements or corrections required, in whole or in part, as the result of (i) normal wear and tear, (ii) accident, disaster or event of force majeure, (iii) misuse, fault or negligence of or by or on behalf of the Customer, (iv) use of the Goods in a manner for which they were not designed, (v) causes external to the Goods such as, but not limited to, power failure or electrical power surges or (vi) use of the Goods in combination with equipment or software not supplied by Thermo Fisher Scientific. If Thermo Fisher Scientific determines that Goods for which the Customer has requested warranty services are not covered by the warranty hereunder, the Customer shall pay or reimburse Thermo Fisher Scientific for all costs of investigating and responding to such request at Thermo Fisher Scientific then prevailing time and material rates. If Thermo Fisher Scientific provides repair services or replacement parts that are not covered by the warranty provided in this Clause, the Customer shall pay Thermo Fisher Scientific therefore at Thermo Fisher Scientific then prevailing time and materials rates. Any installation, maintenance, repair, service, relocation or alteration to or of, or other tampering with, the Goods, performed by any person or entity other than Thermo Fisher Scientific without Thermo Fisher Scientific prior written approval, or any use of replacement parts not supplied by Thermo Fisher Scientific, shall immediately void and cancel all warranties with respect to the affected Goods.

Terms may vary by country. Please contact your local sales office for further information.



Thermo Electron LED GmbH
Zweigniederlassung Osterode
Am Kalkberg, 37520 Osterode am Harz
Germany

thermofisher.com/rotors

© 2010–2022 Thermo Fisher Scientific Inc. All rights reserved.

All trademarks are the property of Thermo Fisher Scientific Inc. and its subsidiaries unless otherwise indicated.

Delrin, TEFLON, and Viton are registered trademarks of DuPont. Noryl is a registered trademark of SABIC. POLYCLEAR is a registered trademark of Hongye CO., Ltd. Hypaque is a registered trademark of Amersham Health As. RULON A and Tygon are registered trademarks of Saint-Gobain Performance Plastics. Alconox is a registered trademark of Alconox. Ficoll is a registered trademark of GE Healthcare. Haemo-Sol is a registered trademark of Haemo-Sol. Triton is a registered trademark of Union Carbide Corporation. Valox is a registered trademark of General Electric Co.

Specifications, terms and pricing are subject to change. Not all products are available in all countries. Please consult your local sales representative for details.

Shown pictures within the manual are examples and may differ considering the set parameters and language. Pictures of the user interface within the manual are showing the English version as example.

Australia +61 39757 4300

Austria +43 1 801 40 0

Belgium +32 9 272 54 82

China +800 810 5118, +400 650 5118

France +33 2 2803 2180

Germany national toll free

0800 1 536 376

Germany international +49 6184 90 6000

India toll free +1800 22 8374

India +91 22 6716 2200

Italy +39 02 95059 552

Japan +81 3 5826 1616

Korea +82 2 2023 0600

Netherlands +31 76 579 55 55

New Zealand +64 9 980 6700

Nordic/Baltic/CIS countries

+358 10 329 2200

Russia +7 812 703 42 15, +7 495 739 76 41

Singapore +82 2 3420 8700

Spain/Portugal +34 93 223 09 18

Switzerland +41 44 454 12 12

UK/Ireland +44 870 609 9203

USA/Canada +1 866 984 3766

Other Asian Countries +852 3107 7600

Countries not listed +49 6184 90 6000

en

