



PanelView 5500 Terminals

Catalog Numbers 2715-T7CD, 2715-T7CD-B, 2715-T7CA, 2715-T7CA-B, 2715-B7CD, 2715-B7CD-B, 2715-B7CA, 2715-B7CA-B, 2715-T9WD, 2715-T9WD-B, 2715-T9WA, 2715-T9WA-B, 2715-T10CD, 2715-T10CD-B, 2715-T10CA, 2715-T10CA-B, 2715-B10CD, 2715-B10CD-B, 2715-B10CA, 2715-B10CA-B, 2715-T12WD, 2715-T12WD-B, 2715-T12WA, 2715-T12WA-B, 2715-T15CD, 2715-T15CD-B, 2715-15CA, 2715-15CA-B, 2715-B15CD, 2715-B15CD-B, 2715-B15CA, 2715-B15CA-B, 2715-T19CD, 2715-T19CD-B, 2715-T19CA, 2715-T19CA-B



Allen-Bradley

by ROCKWELL AUTOMATION

User Manual

Original Instructions

Important User Information

Read this document and the documents listed in the additional resources section about installation, configuration, and operation of this equipment before you install, configure, operate, or maintain this product. Users are required to familiarize themselves with installation and wiring instructions in addition to requirements of all applicable codes, laws, and standards.

Activities including installation, adjustments, putting into service, use, assembly, disassembly, and maintenance are required to be carried out by suitably trained personnel in accordance with applicable code of practice.

If this equipment is used in a manner not specified by the manufacturer, the protection provided by the equipment may be impaired.

In no event will Rockwell Automation, Inc. be responsible or liable for indirect or consequential damages resulting from the use or application of this equipment.

The examples and diagrams in this manual are included solely for illustrative purposes. Because of the many variables and requirements associated with any particular installation, Rockwell Automation, Inc. cannot assume responsibility or liability for actual use based on the examples and diagrams.

No patent liability is assumed by Rockwell Automation, Inc. with respect to use of information, circuits, equipment, or software described in this manual.

Reproduction of the contents of this manual, in whole or in part, without written permission of Rockwell Automation, Inc., is prohibited.

Throughout this manual, when necessary, we use notes to make you aware of safety considerations.



WARNING: Identifies information about practices or circumstances that can cause an explosion in a hazardous environment, which may lead to personal injury or death, property damage, or economic loss.



ATTENTION: Identifies information about practices or circumstances that can lead to personal injury or death, property damage, or economic loss. Attentions help you identify a hazard, avoid a hazard, and recognize the consequence.

IMPORTANT Identifies information that is critical for successful application and understanding of the product.

These labels may also be on or inside the equipment to provide specific precautions.



SHOCK HAZARD: Labels may be on or inside the equipment, for example, a drive or motor, to alert people that dangerous voltage may be present.



BURN HAZARD: Labels may be on or inside the equipment, for example, a drive or motor, to alert people that surfaces may reach dangerous temperatures.



ARC FLASH HAZARD: Labels may be on or inside the equipment, for example, a motor control center, to alert people to potential Arc Flash. Arc Flash will cause severe injury or death. Wear proper Personal Protective Equipment (PPE). Follow ALL Regulatory requirements for safe work practices and for Personal Protective Equipment (PPE).

The following icon may appear in the text of this document.



Identifies information that is useful and can help to make a process easier to do or easier to understand.

	Preface	
	Summary of Changes	7
	Package Contents	7
	Request Corresponding Source for Open Source Packages	7
	Product Release Notes	9
	Additional Resources	9
	Chapter 1	
Overview	About the PanelView 5500 Terminals	11
	Hardware Features	12
	Operator Control	12
	Touch Gestures	14
	Studio 5000 Environment	14
	EtherNet/IP Communication	16
	Typical Configuration	16
	Catalog Number Explanation	16
	Product Selections	16
	Accessories	17
	Ethernet Cables	17
	Chapter 2	
Install the PanelView 5500 Terminal	North American Hazardous Locations	21
	Required Circuit Port Parameters for USB Peripheral Devices	22
	Mounting Considerations	23
	Mounting Clearances	24
	Panel Guidelines	24
	Panel Cutout Dimensions	24
	Product Dimensions	25
	Prepare for Panel Mounting	26
	Mount the Terminal in a Panel	30
	Outdoor Installation	33
	Remove and Replace the Power Terminal Block	34
	Connect to DC Power	36
	Connect to AC Power	37
	Connect to a Network	38
	Ethernet Ports	38
	Device Level Ring Network Topology	39
	Linear Network Topology	40
	Star Network Topology	41
	Initial Startup	41
	Update the Firmware Before You Use the Terminal	42
	Chapter 3	
Configure Terminal Settings	Runtime Environment	46
	Entering Data Using Virtual Keyboards	47
	Log On to the Terminal	49

Log Off of the Terminal 50

Settings Menu 50

Configure the IP Address of the Terminal..... 52

 Use DHCP to Assign an IP Address For the Terminal..... 52

 Assign a Static IP Address For the Terminal 53

Configure a DNS Address For the Terminal..... 54

Configure the Ethernet Ports..... 55

View the Network Diagnostics 56

Adjust the Brightness of the Display 57

Configure the Display Screen Saver 58

Calibrate the Touch Screen 59

Disable Downloads to the Terminal 61

Change the HMI Device Name 62

View the Firmware Revision..... 63

Display Terminal Diagnostics 63

Reboot the Terminal 65

Change the Date and Time 66

View General Information for the Configured Controller 67

Chapter 4

Monitor and Manage Control System Alarms

Alarm Indicator..... 69

Alarm Help Menu..... 70

View the Alarm Summary..... 72

Manage the Alarms..... 73

Alarm Detail-pane Descriptions..... 74

Filter the Alarms 76

Chapter 5

Install and Replace Components

Connect to USB Ports..... 80

 USB Cables 81

Insert an SD Card..... 81

Replace the Battery..... 82

Install a Protective Overlay..... 84

 Clean the Overlay 85

 Remove the Overlay 85

Chapter 6

Update Firmware

Before You Begin..... 87

Firmware Requirements 87

Get the Terminal Firmware 88

Install the ControlFLASH Software 88

Update the Firmware by Using ControlFLASH Software 89

Verify the Firmware Update..... 91

Troubleshooting	Chapter 7	
	Status Indicators	94
	View Diagnostic Information for the Configured Controller.	95
	Troubleshooting Profiles.	95
	Import a Troubleshooting Profile.	96
	Export a Troubleshooting Log.	97
	Terminal Does Not Start Up.	99
	Terminal Restarts Intermittently	99
	Touch Screen Issues	99
	Display Issues	100
	Ethernet Issues.	100
	Cannot Download Application to Terminal.	101
	Performance Is Slow.	101
	Resistance to Chemicals	101
	Clean the Display	102
	Remove Paint and Grease	102
	Equipment Wash Downs	102
	Ship the Terminal.	103
	Restore Factory Defaults.	103
	Index	105

Notes:

This manual describes how to install, configure, operate, and troubleshoot the PanelView™ 5500 terminals. It does not provide procedures on how to create applications that run on the terminals or ladder logic that runs in the controller.

Other tasks that you must do include:

- Configure the Ethernet settings and update the firmware of the terminal.

IMPORTANT You must configure the Ethernet settings and update the firmware before you can download a View Designer project and use the terminal. See [Initial Startup on page 41](#).

- Create an application by using the Studio 5000 View Designer® application.
- Create a project for the controller by using the Studio 5000 Logix Designer® application.

Summary of Changes

This publication contains the following new or updated information. This list includes substantive updates only and is not intended to reflect all changes.

Topic	Page
Added information about outdoor installation.	33

Package Contents

This product is shipped with the following items:

- PanelView 5500 terminal
- Mounting levers for panel installation
- Removable power terminal blocks (AC or DC)
- Product information sheet
- Cutout template

Request Corresponding Source for Open Source Packages

The software included in this product contains copyrighted software that is licensed under one or more open source licenses. Copies of those licenses are included with the software. Corresponding Source for open source packages included in this product can be found at the websites identified in the product documentation.

You may alternately obtain complete Corresponding Source by contacting Rockwell Automation via our Contact form on the Rockwell Automation website: <http://www.rockwellautomation.com/global/about-us/contact/contact.page>. Please include "Open Source" as part of the request text.

IMPORTANT Do not modify the .nvs file. The .nvs file is used in firmware upgrades and a modified .nvs file can cause the firmware upgrade to fail.

Product Release Notes

Product release notes are available online within the Product Compatibility and Download Center.

1. From the Quick Links list on <http://www.ab.com>, choose Product Compatibility and Download Center.

Quick Links

- ▶ Product Directory
- ▶ Product Catalogs
- ▶ Product Certifications
- ▶ Product News
- ▶ Product Configuration and Selection
- ▶ Product Compatibility and Download Center
- ▶ Tools & Resources
- ▶ Literature Library

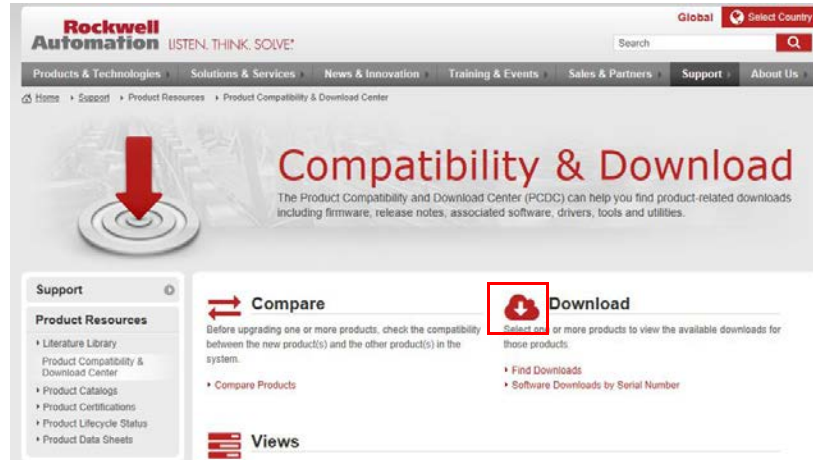

2. Click the Download icon and search for your product.

Start by selecting products

Product Search:

PanelView 5500 All Categories All Families

Example: 1756-L61, L65, Logix, Ethernet *You can also filter by product category or family.*

3. Click the download icon  to access product release notes.

Additional Resources

These documents contain additional information concerning related products from Rockwell Automation.

Resource	Description
PanelView 5500 Terminals Technical Data, publication 2715-TD001	Provides specifications and certifications for the PanelView 5500 terminal.
EtherNet/IP Embedded Switch Technology Application Guide, publication ENET-AP005	Provides information on how to install, configure, and maintain linear, star, and Device Level Ring (DLR) networks using Rockwell Automation® EtherNet/IP™ devices with embedded switch technology.
Industrial Automation Wiring and Grounding Guidelines, publication 1770-4.1	Provides general guidelines for installing a Rockwell Automation industrial system.
Guidelines for Handling Lithium Batteries Technical Data, publication AG-5.4	Provides guidelines to store, handle, install, and dispose of lithium batteries.
Safety Guidelines for the Application, Installation, and Maintenance of Solid-State Controls, publication SGI-1.1	Provides general guidelines for the application, installation, and maintenance of solid-state equipment.
Product Certifications website, rok.auto/certifications	Provides declarations of conformity, certificates, and other certification details.

You can view or download publications at rok.auto/literature.

Notes:

Overview

Topic	Page
About the PanelView 5500 Terminals	11
Hardware Features	12
Operator Control	12
Touch Gestures	14
Studio 5000 Environment	14

Topic	Page
EtherNet/IP Communication	16
Typical Configuration	16
Catalog Number Explanation	16
Product Selections	16
Accessories	17

About the PanelView 5500 Terminals



The PanelView™ 5500 terminals are operator interface devices for monitoring and controlling devices that are attached to ControlLogix® 5570 and CompactLogix™ L1, L2, and L3 controllers over an EtherNet/IP™ network.

Animated graphic and text displays provide operators a view into the operating state of a machine or process. Operators interact with the control system by using the touch screen or keypad of the terminal.

The PanelView 5500 terminals include these features and capabilities:

- Tightly integrated control and design environment allows information to be shared between the PanelView 5500 terminal and the Logix platforms.
- The Studio 5000® environment provides one point of access for both View Designer and Logix Designer applications.
- Connection to one ControlLogix 5570 or CompactLogix L1, L2, or L3 controller with revision 27 firmware or later.
- Supports a maximum of 50 user-defined screens (the screens will increase in future firmware).
- Supports a maximum of 500 Logix-based alarms (the alarms will increase in future firmware).
- Ethernet communication supporting Device Level Ring (DLR), linear, or star network topologies.
- High-speed human machine interface (HMI) button control and easily configured navigation menu.

Hardware Features

The PanelView 5500 terminals are fixed hardware configurations providing a range of display sizes and operator input options.

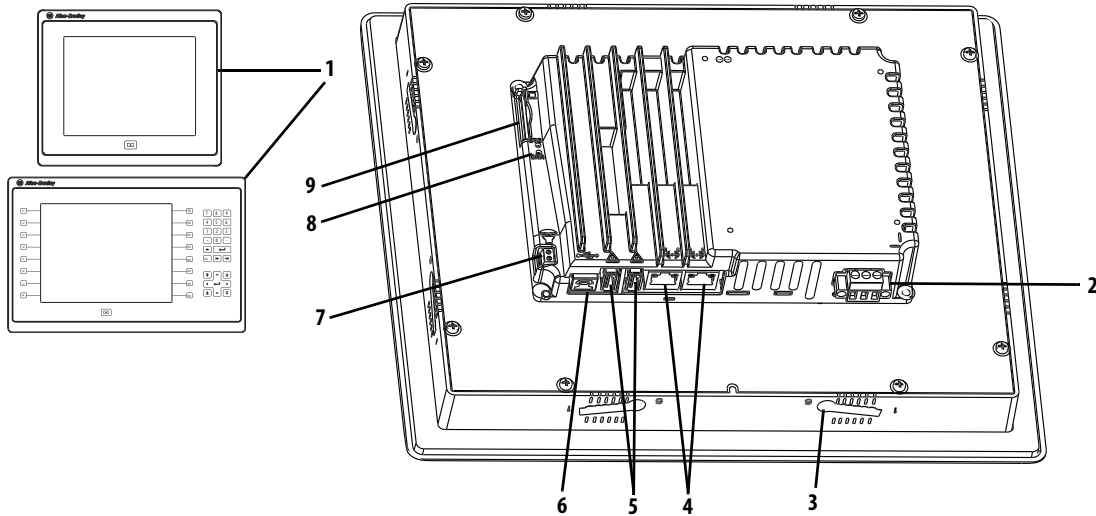

Table 1 - Hardware Features

Item	Feature	Description
1	Display/Keypad	TFT color graphic displays with a touch screen and navigation button in a range of display sizes. Some models also have a keypad and function keys providing additional operator input options. <ul style="list-style-type: none"> • 6.5-in. touch or touch with keypad • 9-in. wide screen with touch • 10.4-in. touch or touch with keypad • 12.1-in. wide screen with touch • 15-in. touch or touch with keypad • 19-in. touch
2	Power	AC or DC power input: <ul style="list-style-type: none"> • 18...30V DC (isolated) • 100...240V AC nom (85...264V AC)
3	Mounting slot	The slots on the top, bottom, and sides of the terminal are used with mounting levers to mount the device to a panel or enclosure. The number of slots varies by terminal size.
4	Ethernet ports	Two 10/100Base-T, Auto MDI/MDI-X, Ethernet ports for controller communication that supports DLR network topology.
5	USB host ports	Two USB 2.0 high-speed (type A) host ports.
6	USB device port	IMPORTANT: The USB device port is not functional. The port will be available in a future software release.
7	Audio out	IMPORTANT: The audio out feature is not functional. The feature will be available in a future software release.
8	Status indicators	Light-emitting diode indicators on back of unit provide status and fault conditions.
9	Secure Digital (SD) card slot	One SD card slot supports catalog number 1784-SDx SD card.

Operator Control

All PanelView 5500 terminals have a color display with a touch screen and navigation key, or a touch screen, navigation key, and keypad for operator control.

- Analog, resistive, touch screens provide accurate, durable touch with excellent reliability for control of industrial applications.

- Keypad models are similar except for the number of function keys to the left (L#) and right (R#) of the display. Larger models have more keys.



ATTENTION: The keypad and touch screen support input from a finger, stylus, and gloved-hand for operation in dry or wet environments. The plastic stylus must have a minimum tip radius of 1.3 mm (0.051 in.). Any other object or tool can damage the keypad or touch screen.



ATTENTION: Do not perform multiple operations simultaneously. Multiple simultaneous operations can result in unintended operation.

- Touch only one operating element on the screen with one finger at one time.
- Press only one key on the terminal at one time.

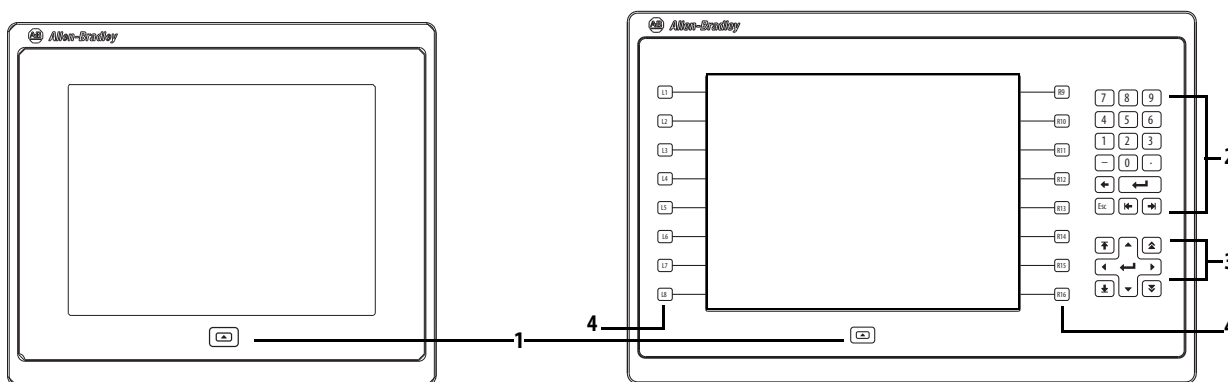

The physical keypad on the PanelView 5500 terminal is used during runtime to initiate actions, control navigation, and enter data. The terminal also supports a virtual keyboard and numeric keypad that opens on PanelView 5500 terminal screens during runtime.

The terminal also supports the use of a physical keyboard and mouse when connected to the USB ports.

Table 2 - PanelView 5500 Terminal Keypad

Item	Feature	Description
1	Navigation button	Opens the navigation menu at the bottom of a screen and displays the contents of a project. The menu allows screen navigation and device configuration.
2	Numeric keypad	Contains numeric, decimal, minus, and these keys: <ul style="list-style-type: none"> Backspace - deletes the character to the left of the insertion point. Enter - inputs the currently highlighted key or enters a blank line if the insertion point is in the text box of the virtual keyboard. Tab-left, Tab-right - selects the previous or next control or input element. Esc - cancels or dismisses a dialog.
3	Navigation keys	Provides navigation control. <ul style="list-style-type: none"> Arrow keys - selects a key on the virtual keyboard that is above, below, left, or right of the selected key. Arrow keys also move the cursor if the cursor is in a text box. Home/End - moves the insertion point to the beginning or end of a text or numeric entry field. Page up/Page down - goes to the next or previous pages of a list.
4	Function keys 6.5-in. terminal 10.4-in. terminal 15-in. terminal	Performs specific commands when configured for a screen or any of its graphic elements. For example, L1 can be configured to go to another screen. L1...L6 and R1...R6 L1...L8 and R1...R8 L1...L10 and R1...R10

Touch Gestures

The PanelView 5500 terminal supports touch gestures to interact with screen elements during runtime. Standard touch functions include these gestures:

- **Tap** – Briefly touch the target on the screen with your fingertip.
- **Drag** – Touch the target, maintain contact with the target, and move your fingertip across the screen.

For a list of actions you can perform by using touch gestures, see the View Designer help.

Studio 5000 Environment

Use the Studio 5000 environment to create HMI applications for the PanelView 5500 terminal.

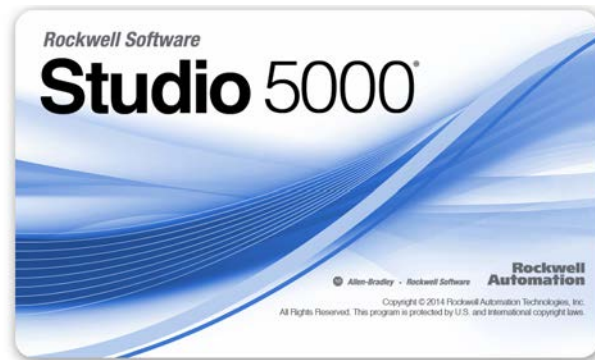

The Studio 5000 environment includes these applications:

- **View Designer** – you can create and design a project for a specific PanelView 5500 terminal and download the project to the terminal.

You can create an application for any PanelView 5500 terminal and reuse that same application across the entire platform.

- **Logix Designer** – you can develop control logic for a CompactLogix or ControlLogix controller and download the logic to the controller.

Figure 1 - How Studio 5000 Applications Work Together

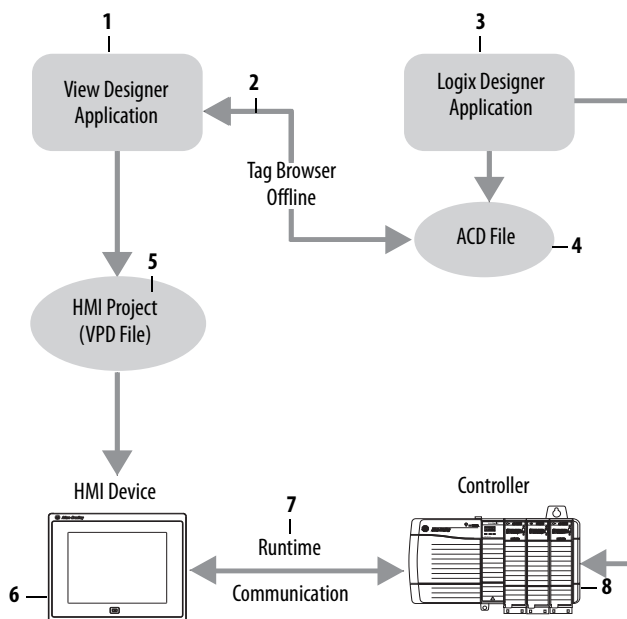

The table describes how the View Designer and Logix Designer applications work together to create an HMI runtime project.

Table 3 - Studio 5000 Applications and Tools

Item	Component	Description
1	View Designer application	A Studio 5000 application that is used to build HMI projects. View Designer projects are stored as .VPD files that can be downloaded to the PanelView 5500 terminal.
2	Tag browser	A tool that is used to search for and select tags within a Logix Designer ACD project file. You can bind the tags to graphic element properties and properties of an HMI screen. View Designer uses the tag browser to read data from an ACD file.
3	Logix Designer application	A Studio 5000 application that is used to develop control logic for an industrial automation system. Logix Designer interfaces with controllers to read and write tag information. Logix Designer projects are stored as .ACD files that can be downloaded to the controller.
4	ACD file	An Automation Controller Database (ACD) file. An ACD file is a Logix Designer project file that contains the logic or code, including tags and data types, which runs within a controller.
5	HMI project (VPD file)	A View Project Database (VPD) file. A VPD project is a file that contains the operator interface application, including HMI screens, controller references, and information about the HMI device to run the application.
6	HMI device	A Human Machine Interface (HMI) device, such as the PanelView 5500 terminal, which runs the HMI project. At runtime, the HMI device communicates directly with the controller.
7	Runtime	The environment in which the runtime HMI project communicates with the controller. During runtime, the HMI device runs the downloaded project, exchanges data with the controller, animates displayed data, and responds to operator input.
8	Controller	A logic controller such as a ControlLogix or CompactLogix 5370 controller.

EtherNet/IP Communication

The PanelView 5500 terminals contain EtherNet/IP embedded switch technology. These terminals communicate with ControlLogix controllers over an Ethernet connection with DLR or linear network topologies. Star technology is also supported when using switches.

The PanelView 5500 terminals can reside on EtherNet/IP networks that run integrated motion and CIP Sync applications without adverse performance. The terminal is not a consumer or producer of CIP Sync or motion packets.

Typical Configuration

Traditional DLR, linear, and star network topologies are supported. See these topics for examples:

- [Device Level Ring Network Topology on page 39](#)
- [Linear Network Topology on page 40](#)
- [Star Network Topology on page 41](#)

Catalog Number Explanation

This table provides an explanation of the catalog numbers.

Bulletin	Input Type	Display Size	Display Type	Power	Option
2715-	T = Touch	7 = 6.5-in.	C = Color, standard aspect ratio	A = AC	-B = No brand identity
	B = Keypad with Touch	9 = 9-in.	W = Color, wide aspect ratio	D = DC isolated	
		10 = 10.4-in.			
		12 = 12.1-in.			
		15 = 15-in.			
		19 = 19-in.			

Product Selections

This table provides information for the product selections.

Cat. No. ⁽¹⁾		Display		Ethernet	Power	Memory	
Touch	Key and Touch	Size	Type	DLR	AC or DC	RAM	User ⁽²⁾
2715-T7CD	2715-B7CD	6.5-in.	VGA	Yes	DC	512 MB	250 MB
2715-T7CA	2715-B7CA		TFT Color		AC		
2715-T9WD	–	9-in. wide	WVGA		DC		
2715-T9WA	–		TFT Color		AC		
2715-T10CD	2715-B10CD	10.4-in.	SVGA		DC		
2715-T10CA	2715-B10CA		TFT Color		AC		
2715-T12WD	–	12.1-in. wide	WXGA		DC		
2715-T12WA	–		TFT Color		AC		
2715-T15CD	2715-B15CD	15-in.	XGA		DC		
2715-T15CA	2715-B15CA		TFT Color		AC		
2715-T19CD	–	19-in.	SXGA		DC		
2715-T19CA	–		TFT Color		AC		

(1) Add -B to the end of a catalog number to order a terminal without the Allen-Bradley logo and product identification, for example, 2715-T7CD-B.

(2) Memory that is available for you to store applications.

Accessories

[Table 4](#)...[Table 8](#) list accessories for the PanelView 5500 terminals.

Table 4 - Protective Overlays

Cat. No. ⁽¹⁾	Display Size	Operator Input	
		Touch	Key and Touch
2711P-RGT7SP	6.5-in.	•	
2711P-RGB7P			•
2711P-RGT9SP	9-in. wide	•	
2711P-RGT10SP	10.4-in.	•	
2711P-RGB10P			•
2711P-RGT12SP	12.1-in. wide	•	
2711P-RGT15SP	15-in.	•	
2711P-RGB15P			•
2711P-RGT19P	19-in.	•	

(1) Three overlays are shipped with each catalog number.

Table 5 - Power Supplies and Power Terminal Blocks

Cat. No.	Description	Quantity
1606-XLP95E	DIN rail power supply, 24...28V DC output voltage, 95 W	1
1606-XLP100E	DIN rail power supply, 24...28V DC output voltage, 100 W	1
2711P-RSACDIN	DIN rail power supply, AC-to-DC, 100...250V AC, 50...60 Hz	1
2711P-RTBAP	3-pin AC power terminal block (gray with black labels for L1, L2N, and \ominus)	10
2711P-RTBDSP	3-pin DC power terminal block (black with white labels for +, -, and GND)	10

Table 6 - Mounting Hardware

Cat. No.	Description	Quantity
2711P-RMCP ⁽¹⁾	Mounting levers (black)	16

(1) Catalog number 2711P-RMCP mounting levers are used with the PanelView 5500 terminals. Do not use gray mounting levers; they are not compatible with PanelView 5500 terminals.

Table 7 - Secure Digital (SD) Cards

Cat. No.	Description
1784-SD1	1 GB SD card
1784-SD2	2 GB SD card

Table 8 - Battery Replacement

Cat. No.	Description	Quantity
2711P-RY2032	Lithium coin cell battery, CR2032 equivalent	1

Ethernet Cables

See the Industrial Ethernet Media Brochure, publication [1585-BR001B](#), for recommended Ethernet cables and media solutions.

Notes:

Install the PanelView 5500 Terminal

Topic	Page
North American Hazardous Locations	21
Mounting Considerations	23
Mounting Clearances	24
Panel Guidelines	24
Panel Cutout Dimensions	24
Product Dimensions	25
Prepare for Panel Mounting	26
Mount the Terminal in a Panel	30
Outdoor Installation	33
Remove and Replace the Power Terminal Block	34
Connect to DC Power	36
Connect to AC Power	37
Connect to a Network	38
Initial Startup	41



ATTENTION: Do not use a PanelView™ 5500 terminal for emergency stops or other controls critical to the safety of personnel or equipment. Use separate hard-wired operator interface devices that do not depend on solid-state electronics.



ATTENTION: Environment and Enclosure

This equipment is intended for use in a Pollution Degree 2 industrial environment, in overvoltage Category II applications (as defined in IEC 60664-1), at altitudes up to 2000 m (6561 ft) without derating.

The terminals are intended for use with programmable logic controllers. Terminals that are AC powered must be connected to the secondary of an isolating transformer.

This equipment is considered Group 1, Class A industrial equipment according to IEC CISPR 11. Without appropriate precautions, there may be difficulties with electromagnetic compatibility in residential and other environments due to conducted or radiated disturbances.

Korean Radio Wave Suitability Registration - When so marked this equipment is registered for Electromagnetic Conformity Registration as business equipment (A), not home equipment. Sellers or users are required to take caution in this regard.

이 기기는 업무용 (A 급) 전자파적합기기로서 판매자 또는 사용자는 이 점을 주의하시기 바라며, 가정외의 지역에서 사용하는 것을 목적으로 합니다.

This equipment is supplied as open-type equipment. It must be mounted within an enclosure that is suitably designed for those specific environmental conditions that will be present and appropriately designed to prevent personal injury resulting from accessibility to live parts. The interior of the enclosure must be accessible only by the use of a tool. The terminals meet specified NEMA, UL Type, and IEC ratings only when mounted in a panel or enclosure with the equivalent rating. Subsequent sections of this publication may contain additional information regarding specific enclosure type ratings that are required to comply with certain product safety certifications.

In addition to this publication, see the following:

- Industrial Automation Wiring and Grounding Guidelines, publication [1770-4.1](#), for additional installation requirements.
- NEMA 250 and IEC 60529, as applicable, for explanations of the degrees of protection provided by different types of enclosure.





ATTENTION: Wiring and Safety Guidelines

Use publication NFPA 70E, Electrical Safety Requirements for Employee Workplaces, IEC 60364 Electrical Installations in Buildings, or other applicable wiring safety requirements for the country of installation when wiring the devices. In addition to the NFPA guidelines, here are some other guidelines to follow:

- Connect the device and other similar electronic equipment to its own branch circuit.
- Protect the input power by a fuse or circuit breaker rated at no more than 15 A.
- Route incoming power to the device by a separate path from the communication lines.
- Cross power and communication lines at right angles if they must cross.
- Communication lines can be installed in the same conduit as low-level DC I/O lines (less than 10V).
- Shield and ground cables appropriately to avoid electromagnetic interference (EMI). Grounding minimizes noise from EMI and is a safety measure in electrical installations.

For more information on grounding recommendations, refer to the National Electrical Code published by the National Fire Protection Association.

North American Hazardous Locations

The following information applies when operating this equipment in hazardous locations.	Informations sur l'utilisation de cet équipement en environnements dangereux.
<p>ATTENTION: When marked, these products are suitable for use in "Class I, Division 2, Groups A, B, C, D"; Class I, Zone 2, Group IIC hazardous locations and nonhazardous locations only. Each product is supplied with markings on the rating nameplate indicating the hazardous location temperature code. When combining products within a system, the most adverse temperature code (lowest "T" number) may be used to help determine the overall temperature code of the system. Combinations of equipment in your system are subject to investigation by the local Authority Having Jurisdiction at the time of installation.</p>	<p>ATTENTION: Les produits marqués "CL I, DIV 2, GP A, B, C, D" ne conviennent qu'à une utilisation en environnements de Classe I Division 2 Groupes A, B, C, D dangereux et non dangereux. Chaque produit est livré avec des marquages sur sa plaque d'identification qui indiquent le code de température pour les environnements dangereux. Lorsque plusieurs produits sont combinés dans un système, le code de température le plus défavorable (code de température le plus faible) peut être utilisé pour déterminer le code de température global du système. Les combinaisons d'équipements dans le système sont sujettes à inspection par les autorités locales qualifiées au moment de l'installation.</p>
<div style="display: flex; align-items: center;">  <div> <p>WARNING: EXPLOSION HAZARD</p> <ul style="list-style-type: none"> • Do not disconnect equipment unless power has been removed or the area is known to be nonhazardous. • Do not disconnect connections to this equipment unless power has been removed or the area is known to be nonhazardous. Secure any external connections that mate to this equipment by using screws, sliding latches, threaded connectors, or other means provided with this product. • Substitution of components may impair suitability for Class I, Division 2. • Peripheral equipment must be suitable for the location in which it is used. • The battery in this product must be changed only in an area known to be nonhazardous. • All wiring must be in accordance with Class I, Division 2 wiring methods of Article 501 of the National Electrical Code and/or in accordance with Section 18-1J2 of the Canadian Electrical Code, and in accordance with the authority having jurisdiction. </div> </div>	<div style="display: flex; align-items: center;">  <div> <p>AVERTISSEMENT : RISQUE D'EXPLOSION</p> <ul style="list-style-type: none"> • Couper le courant ou s'assurer que l'environnement est classé non dangereux avant de débrancher l'équipement. • Couper le courant ou s'assurer que l'environnement est classé non dangereux avant de débrancher les connecteurs. Fixer tous les connecteurs externes reliés à cet équipement à l'aide de vis, loquets coulissants, connecteurs filetés ou autres moyens fournis avec ce produit. • La substitution de composants peut rendre cet équipement inadapté à une utilisation en environnement de Classe I, Division 2. • Les équipements périphériques doivent s'adapter à l'environnement dans lequel ils sont utilisés. • S'assurer que l'environnement est classé non dangereux avant de changer la pile ou le module horloge temps réel de ce produit. • Tous les systèmes de câblage doivent être de Classe I, Division 2, conformément aux méthodes de câblage indiquées dans les Articles 501 du National Electrical Code (Code Electrique National) et/ou conformément à la Section 18-1J2 du Canadian Electrical Code (Code Electrique Canadien), et en fonction de l'autorité de juridiction. </div> </div>

The terminals have a temperature code of T4 when operating in a 55 °C (131 °F) maximum ambient temperature. Do not install product in environments where atmospheric gases have ignition temperatures less than 135 °C (275 °F).

Required Circuit Port Parameters for USB Peripheral Devices

This product contains USB host ports that comply with hazardous location environments. Field-wiring compliance requirements are provided in compliance with the National Electrical Code, Article 500.

Figure 2 - PanelView 5500 Control Drawing

Associated Nonincendive Field Wiring Apparatus

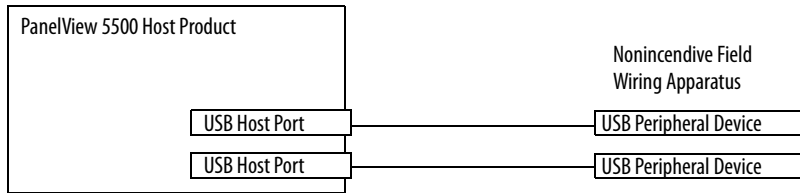

PanelView 5500 terminals provide two, separately powered USB host ports. [Table 9](#) defines the circuit parameters of these USB host ports.

Table 9 - Circuit Parameters for USB Host Ports

Parameter	Value	Parameter Definition	
$V_{oc(USB)}$	5.25V DC	Open circuit voltage of each host USB port. The maximum applied voltage rating, $V_{max(Peripheral)}$, of each USB peripheral device shall be greater than or equal to $V_{oc(USB)}$.	$V_{max(Peripheral)} \geq V_{oc(USB)}$ (as appropriate)
$I_{sc(USB)}$	1.68 A	Maximum output current of each host USB port. The maximum current, $I_{max(Peripheral)}$, to which each USB peripheral device can be subjected shall be greater than or equal to $I_{sc(USB)}$.	$I_{max(Peripheral)} \geq I_{sc(USB)}$
$C_{a(USB)}$	10 μ F	This value is the maximum total capacitance that can be connected to each USB host port. The total capacitance of each USB peripheral device and its associated cable must not exceed the indicated value. The maximum total capacitance, $C_{i(Peripheral)}$, and cable capacitance of each separate USB peripheral device shall be less than or equal to $C_{a(USB)}$.	$C_{i(Peripheral)} + C_{cable(USB)} \leq C_{a(USB)}$
$L_{a(USB)}$	15 μ H	This value is the maximum total inductance that can be connected to each USB host port. The total inductance of each USB peripheral device and its associated cable must not exceed the indicated value. The maximum total inductance, $L_{i(Peripheral)}$, and cable inductance of each separate USB peripheral device shall be less than or equal to $L_{a(USB)}$.	$L_{i(Peripheral)} + L_{cable} \leq L_{a(USB)}$

Application Information

Per the National Electrical Code, the circuit parameters of associated field-wiring apparatus for use in hazardous locations shall be coordinated with the host product such that their combination remains nonincendive. PanelView 5500 terminals and the USB peripheral devices shall be treated in this manner.

The USB peripheral devices and their associated cabling shall have circuit parameters with the limits given in [Table 9](#) for them to remain nonincendive when used with the PanelView 5500 USB host ports.

If cable capacitance and inductance are not known, use the following values from ANSI/ISA-RP 12.06.01-2003:

$$C_{\text{cable}} = 197 \text{ pF/m (60 pF/ft)}$$

$$L_{\text{cable}} = 0.7 \text{ } \mu\text{H/m (0.20 } \mu\text{H/ft)}$$

Nonincendive field wiring must be wired and separated in accordance with 501.10(B)(3) of the National Electrical Code (NEC) ANSI/NFPA 70 or other local codes as applicable. This associated nonincendive field wiring apparatus has not been evaluated for use in combination with another associated nonincendive field wiring apparatus.

Mounting Considerations

Consider the following when mounting the terminal:

- Mount the terminal at a height suitable for operators. You can mount the cabinet at a level other than the operator floor.
- Use appropriate light. Do not operate the terminal in direct sunlight.
- Terminals are rated to operate at mounting angles between 0...180 degrees.

Figure 3 - Acceptable and Unacceptable Mounting Positions

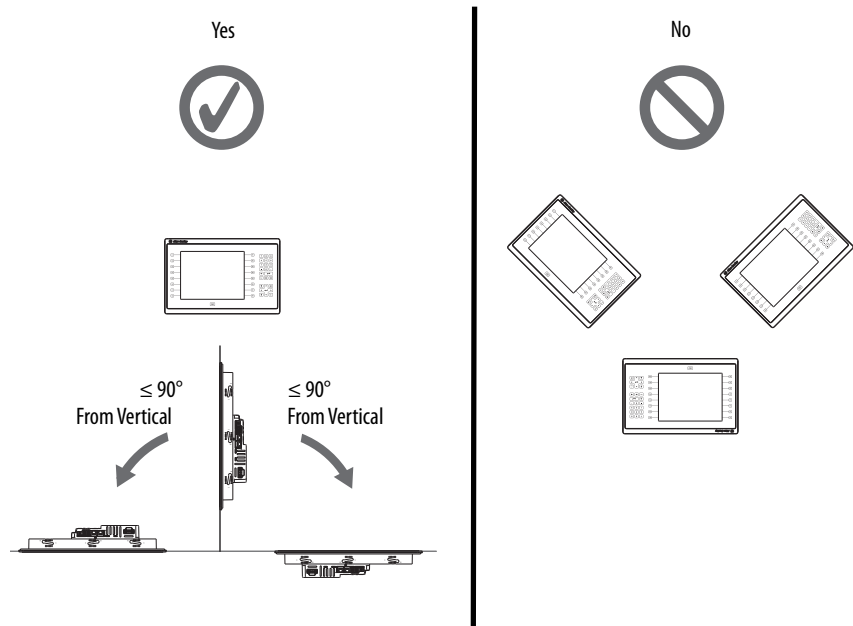

ATTENTION: Failure to follow these guidelines can result in personal injury or damage to the panel components.

Mounting Clearances

Plan for adequate space around the terminal, inside the enclosure, for ventilation and cables. Consider the heat from other devices in the enclosure. The ambient temperature around the terminal must be 0...55 °C (32...131 °F).

Table 10 - Minimum Required Clearances

Product Area	Minimum Clearance
Top	51 mm (2 in.)
Bottom	102 mm (4 in.)
Side	25 mm (1 in.) 102 mm (4 in.) is required to insert and remove an SD card or cable on one side
Back	0 mm (0 in.)

Panel Guidelines

The terminals are panel-mounted devices that mount in the door or wall of a NEMA, UL Type, or IP rated enclosure:

- Enclosure panels must meet the panel thickness requirements in [Table 13 on page 26](#).
- The material strength and stiffness of the panel must be sufficient to hold the terminal and maintain an appropriate seal against water and dust.
- The panel surface must be flat and free of imperfections to maintain an adequate seal and NEMA, UL Type, or IP ratings.

Panel Cutout Dimensions

Use the template that is shipped with your terminal to mark the cutout dimensions.

Table 11 - PanelView 5500 - Panel Cutout Dimensions

Terminal Size	Input Type	Height, mm (in.)	Width, mm (in.)
6.5-in.	Keypad and touch	142 (5.59)	237 (9.33)
	Touch	142 (5.59)	184 (7.24)
9-in.	Touch	162 (6.38)	252 (9.92)
10.4-in.	Keypad and touch	224 (8.82)	335 (13.19)
	Touch	224 (8.82)	269 (10.59)
12.1-in.	Touch	218 (8.58)	312 (12.28)
15-in.	Keypad and touch	290 (11.42)	418 (16.46)
	Touch	290 (11.42)	353 (13.90)
19-in.	Touch	383 (15.08)	457 (17.99)

Product Dimensions

The table provides product dimensions. The 10.4-inch touch and combination keypad with touch terminals are shown for illustrative purposes. All other terminal sizes look similar.

Figure 4 - PanelView 5500 Terminal Dimensions (the 10.4-in. terminal is shown)

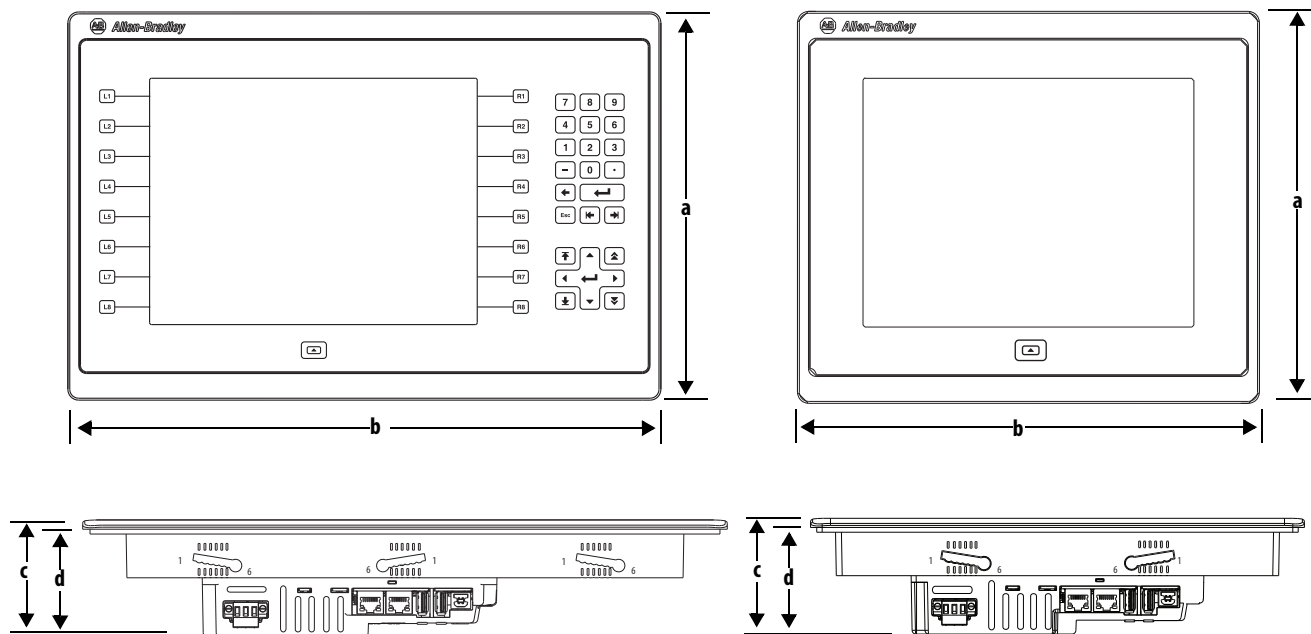

Table 12 - PanelView 5500 Terminal Dimensions

Terminal Size	Input Type	Height (a) mm (in.)	Width (b) mm (in.)	Overall Depth (c) mm (in.)	Mounted Depth (d) mm (in.)
6.5-in.	Keypad and touch	179 (7.05)	285 (11.22)	69.6 (2.74)	63.6 (2.50)
	Touch	170 (6.69)	212 (8.35)		
9-in.	Touch	190 (7.48)	280 (11.02)		
10.4-in.	Keypad and touch	252 (9.92)	385 (15.16)		
	Touch	252 (9.92)	297 (11.69)		
12.1-in.	Touch	246 (9.69)	340 (13.39)		
15-in.	Keypad and touch	329 (12.95)	484 (19.06)		
	Touch	318 (12.52)	381 (15.00)		
19-in.	Touch	411 (16.18)	485 (19.09)		

TIP When mounted in a panel, the front of the bezel extends less than 6.36 mm (0.25 in.) from the front of the panel.

Prepare for Panel Mounting

Before mounting your PanelView 5500 terminal in a panel, read this section and the entire installation procedure on [page 30](#).

IMPORTANT Catalog number 2711P-RMCP mounting levers (black) are used with PanelView 5500 terminals. Do not use gray mounting levers; they are not compatible with PanelView 5500 terminals.

Mounting levers insert into the slots around the bezel to secure the terminal in the panel. The number of levers varies by terminal size.

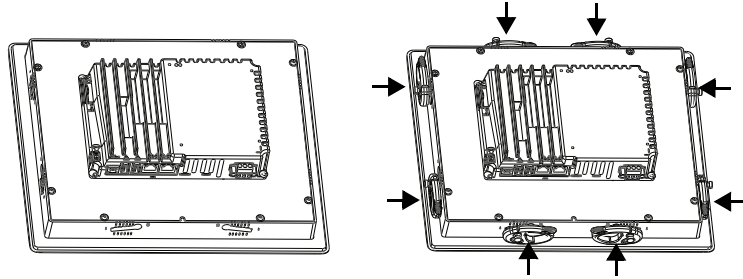

Each slot has six notches with alignment marks that are locking positions for a lever. The thickness of the panel in which you mount the terminal determines the locking position that is required to maintain a NEMA, UL Type, or IP seal.

Table 13 - Lever Locking Positions

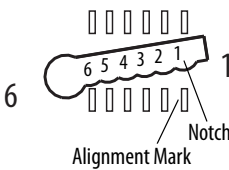
Mounting Slot	Lever Lock Position	Panel Thickness Range	Typical Gauge
Orientation of Slot Varies 	1	1.50...2.01 mm (0.060...0.079 in.)	16
	2	2.03...2.64 mm (0.080...0.104 in.)	14
	3	2.67...3.15 mm (0.105...0.124 in.)	12
	4	3.17...3.66 mm (0.125...0.144 in.)	10
	5	3.68...4.16 mm (0.145...0.164 in.)	8/9
	6	4.19...4.80 mm (0.165...0.188 in.)	7

Always orient a lever vertically before inserting it into a slot. This orientation is the only way to slide the lever knob within the slot for positioning. After sliding the lever to a specific notch, rotate the lever toward the panel to lock it in position. The flat side of the lever must come into contact with the panel.

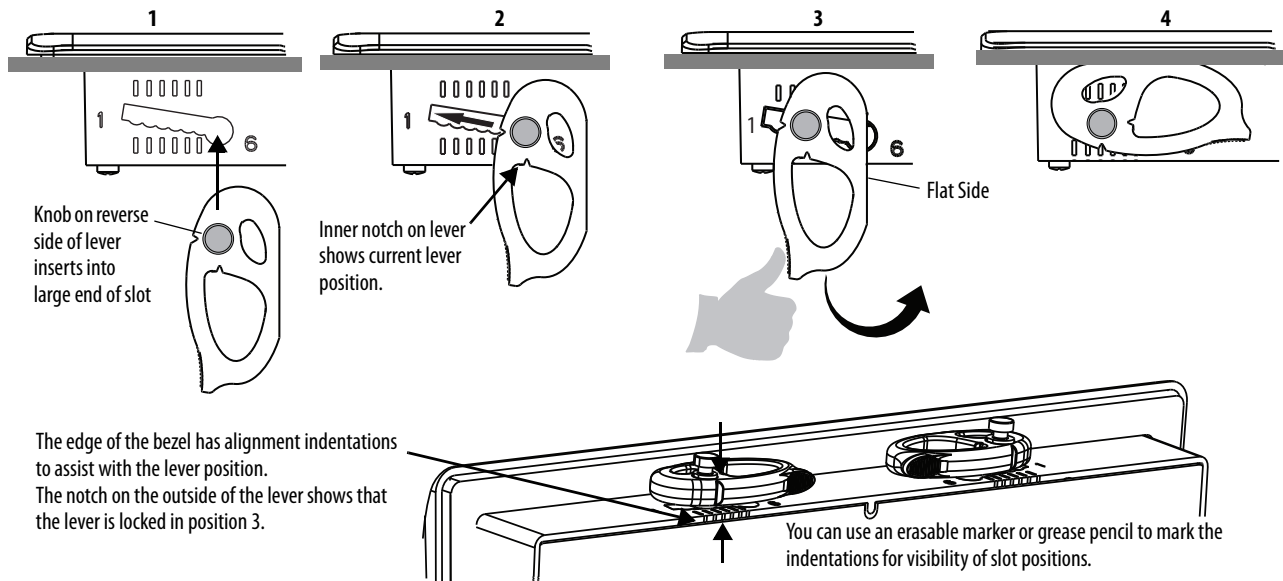

Initially, you secure the terminal in the panel by sliding each lever to a position that is one or two notches greater than the final lock position. For example, if the final lock position is 3, slide each lever to position 4 or 5.

Follow the locking sequence and lever orientations for each terminal as shown in [Figure 5 on page 29](#).

TIP If the lock position is 6, slide lever to large end of slot or insertion hole.

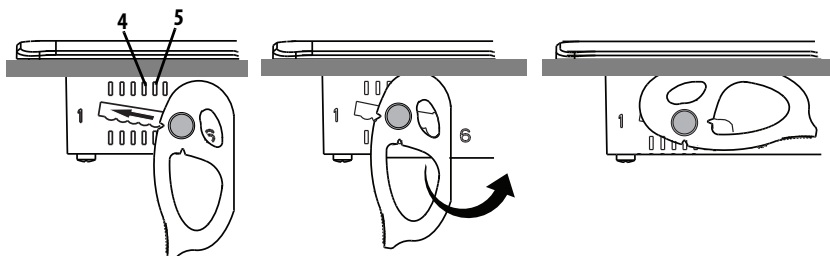

You then adjust each lever to its final lock position in the same sequence as shown in [Figure 5 on page 29](#).

IMPORTANT This process equalizes the pressure of the levers against the panel at a gradual rate reducing the probability of broken clamps.

This figure shows the lever orientation and lock sequence for a 10.4-in. touch terminal.

The levers in this example are locked in position 3, which is appropriate for a panel thickness of 2.67...3.15 mm (0.105...0.124 in.).

Notch shows locked position.

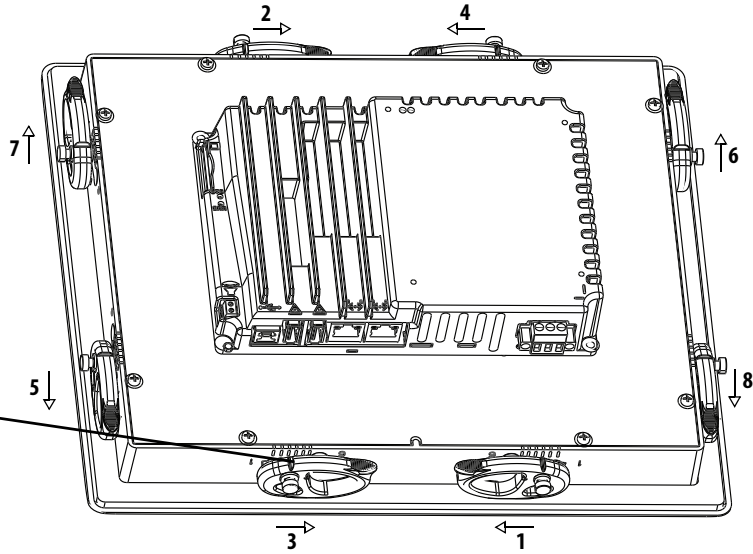

10.4-in. Touch Terminal Shown

Figure 5 - Mounting Lever Orientation and Lock Sequence

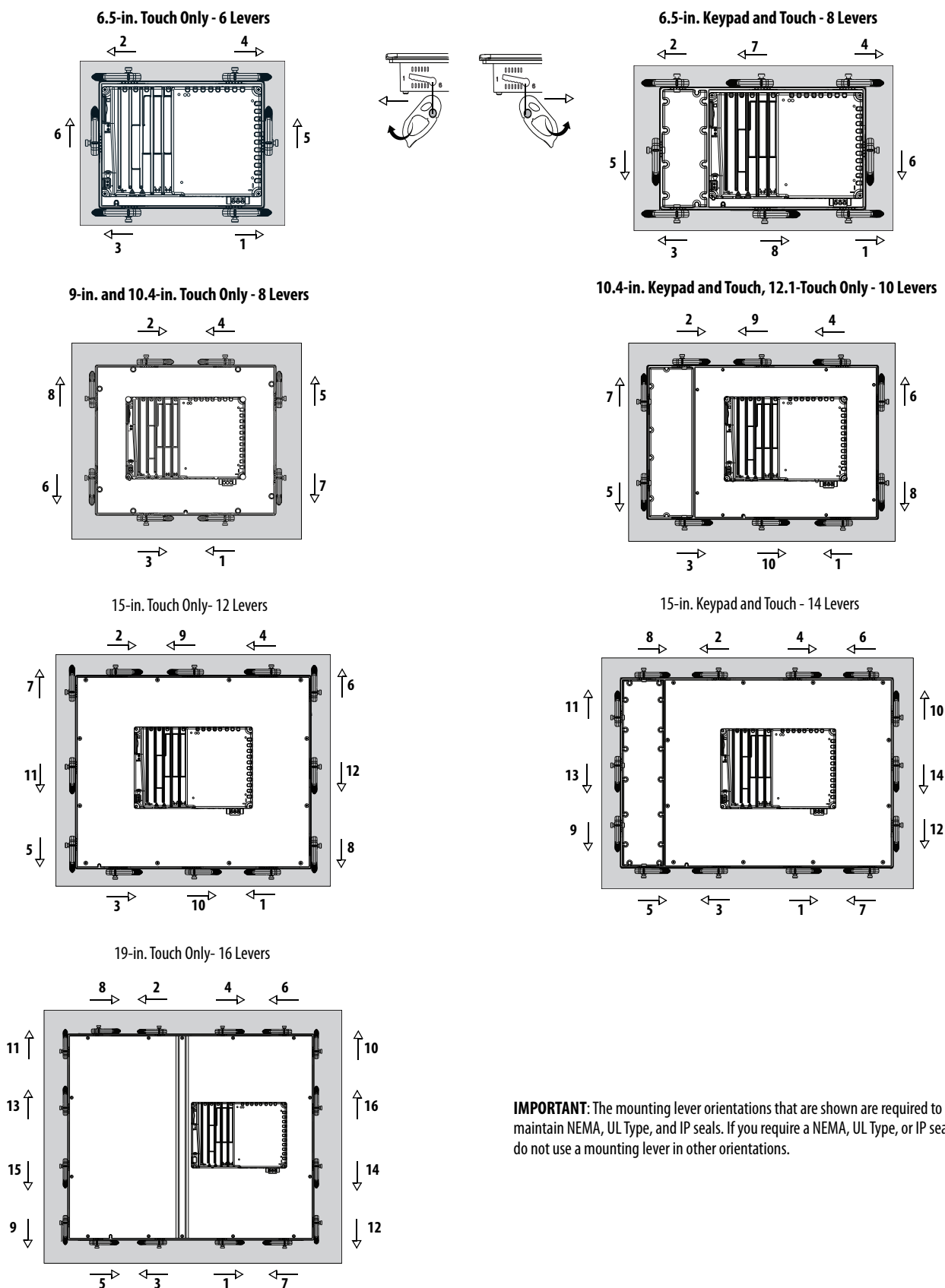

Mount the Terminal in a Panel

The PanelView 5500 terminals were designed for single-person installation. No tools are required except for the tools that are used to make the panel cutout.

To mount the terminal in a panel, follow these steps.



ATTENTION:

Disconnect all electrical power from the panel before making the panel cutout. Make sure that the area around the panel cutout is clear and that the panel is clean of any debris, oil, or other chemicals.

Make sure that metal cuttings do not enter any components that are already installed in the panel and that the edges of the cutout have no burrs or sharp edges.

Failure to follow these precautions can result in personal injury or damage to panel components.

1. Use the cutout dimensions on [page 24](#) to cut an opening in the panel.
2. Verify that the sealing gasket is present on the terminal.

This gasket forms a compression type seal. Do not use sealing compounds.

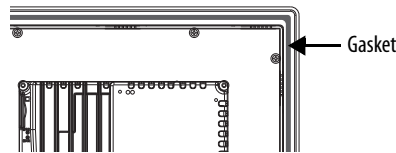

3. Insert and stabilize the terminal in the panel cutout.
 - a. Insert levers in the top corner slots in the orientation that is shown in [Figure 5 on page 29](#) and rotate the non-flat side of the levers toward panel.

TIP The mounting levers for PanelView 5500 terminals are black (catalog number 2711P-RMCP).

Do not use gray mounting levers; they are not compatible with PanelView 5500 terminals.

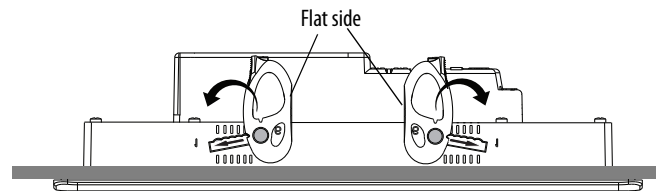
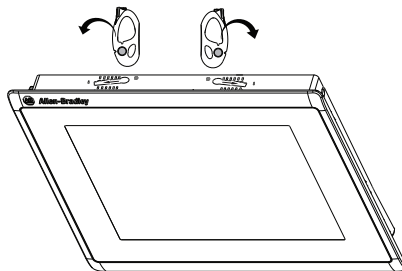

- b. Tilt the terminal toward the panel cutout and guide upward into the cutout. Make sure that the levers stay intact.

TIP The levers prevent the terminal from falling out of the panel.

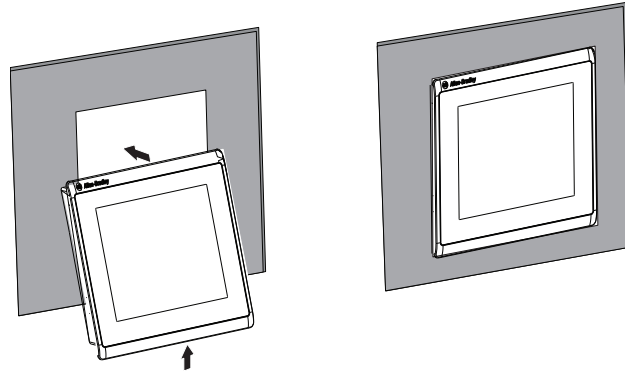

- c. Pull the top of the terminal toward you to verify that the levers are still intact and the terminal is stabilized in the panel.

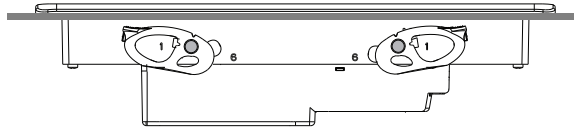

- d. Insert the remaining levers in the slots by using the orientations in [Figure 5 on page 29](#) that are correct for your terminal size.
The direction that you rotate the levers varies for each terminal size.

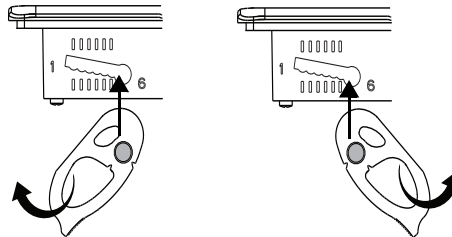

4. Slide and rotate each lever to a notch that is one or two positions greater than the final lock position. Start with the first lever in the sequence.

For example, if the final lock position is 3, slide the lever to notch 4 or 5.

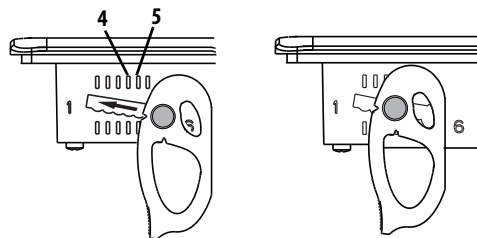

TIP To help position the levers and identify the final slot position, use the alignment marks or previous marks you made on the bezel.

- See [Table 13 on page 26](#) to get the final lock position of the levers.
- See [Figure 5 on page 29](#) to get the locking sequence.
- Rotate each lever until its flat side comes in contact with the panel.

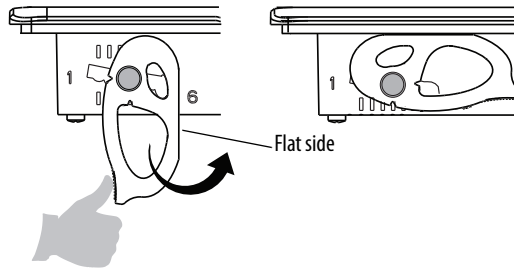

5. Adjust each lever to its final lock position shown in the same locking sequence in [Figure 5 on page 29](#).
 - a. Unlock lever one in the sequence by rotating it away from the bezel.

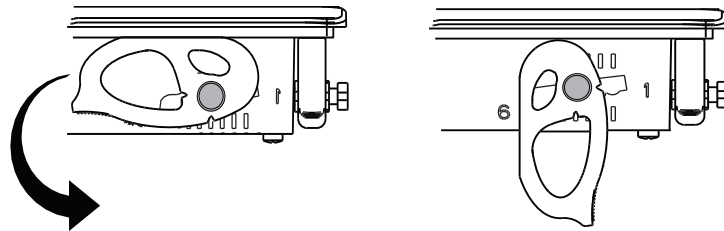

- b. With the lever positioned vertically to the slot, slide the lever to the final locking position in [Table 13 on page 26](#).
The outer notch of the lever aligns with the bezel indentation.
 - c. Carefully rotate the lever back toward panel.

TIP A broken lever does not damage the product.

- d. Lock the remaining levers to their final position.
6. Inspect all levers and make sure each is in the correct locked position.



ATTENTION: All levers must be in the correct and same locked position to provide an adequate gasket seal between the terminal and the panel. Rockwell Automation assumes no responsibility for water or chemical damage to the terminal or other equipment within the enclosure because of improper installation.

The notch on the outside of lever shows its locked position. These two views show levers that are locked in position 3.

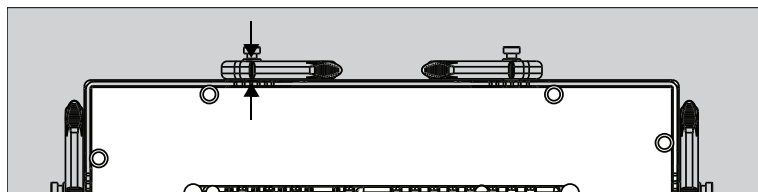
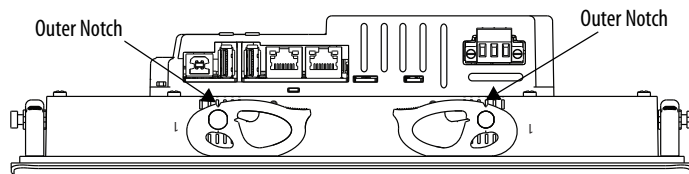

Outdoor Installation



ATTENTION: Failure to follow the recommended installation practices for outdoor use will substantially reduce product life and void product warranty.

When using a 2715 terminal outdoors, you must follow the recommendations outlined below to maximize the field life of the front bezel and display:

- Add UV protection and shielding (sun shade or sun visor)
- Manage terminal temperature
- Install a protective overlay
- Consider terminal orientation
- Select a proper enclosure

Ultraviolet (UV) and infrared radiation can reduce the field life of any electronic terminal. While the materials used in the terminal bezels provide long field life, that life can be improved by proper installation and by following the suggested guidelines.

UV radiation from the sun causes all plastics to fade or yellow and become brittle over time. Using a sacrificial antiglare overlay (see [Table 4 on page 17](#)) helps protect the front of the terminal from direct exposure to UV radiation, and by avoiding direct sunlight exposure, this overlay greatly increases its field life. Another recommendation for UV protection is a shield to shade the terminal from the direct rays of the sun. This also helps reduce the solar heating caused by direct sun exposure. When installing a sun shield that closes over the display, the temperature between the sun shield and the display cannot exceed the maximum temperature of the display, which is 55 °C (131°F)⁽¹⁾. Adequately ventilate all sun shields to help prevent excess heat rise on the terminal display.

Use stirring fans or active cooling in high altitude and high ambient temperature locations to keep the internal enclosure temperature below 55 °C (131 °F)⁽¹⁾.

Ensure the ambient temperature the product is operating in does not fall below its minimum rated 0 °C (32 °F).

The temperature differential between the inside of the terminal enclosure and the front panel must be minimized to reduce the potential for condensation and possible pressure variation between the inside and outside of the product.

Avoid placing the terminal on the south (north in the southern hemisphere) or west side of the cabinet. This reduces the heat rise due to solar heating during the hottest part of the day.

Mount the terminal vertically to minimize solar heating on the display. Do not mount the terminal in a sloped enclosure if it exposes the terminal to direct sunlight.

(1) The maximum temperature of the 19-in. terminal is 50 °C (122 °F).

Protect the terminal from water and dust by mounting it in a proper enclosure following the instructions in the PanelView 5500 Terminals Product Information, publication [2715-PC002](#). The terminals meet specified NEMA, UL Type, and IEC ratings only when properly mounted in a panel or enclosure with the equivalent rating. Other sections of this publication may contain additional information regarding specific enclosure type ratings that are required to comply with certain product safety certifications.

Remove and Replace the Power Terminal Block

The product has a 3-pin terminal block for power connections. You can remove the terminal block for ease of installation, wiring, and maintenance.



WARNING: Explosion Hazard

If you connect or disconnect wiring while the power is on, an electric arc can occur. This arc can cause an explosion in hazardous location installations. Be sure that power is removed and the area is nonhazardous before proceeding. Failure to remove power can result in electrical shock or damage to the terminal.

The terminal block has different markings for AC and DC power connections.

Use a 0.6 x 3.5 mm screwdriver for terminal block wiring.

Table 14 - Wire Specifications for the Power Input Terminal Block

Wire Type	Dual-wire Size ⁽¹⁾	Single-wire Size	Strip Length	Screw Torque
Stranded or solid Cu 90 °C (194 °F)	0.3...1.3 mm ² 22...16 AWG	0.3...2.1 mm ² (22...14 AWG)	7 mm (0.28 in.)	0.4...0.5 N·m (3.5...4.4 lb-in)

(1) Two-wire maximum per terminal.

To remove the terminal block, follow these steps.

1. Loosen the two screws that secure the terminal block.

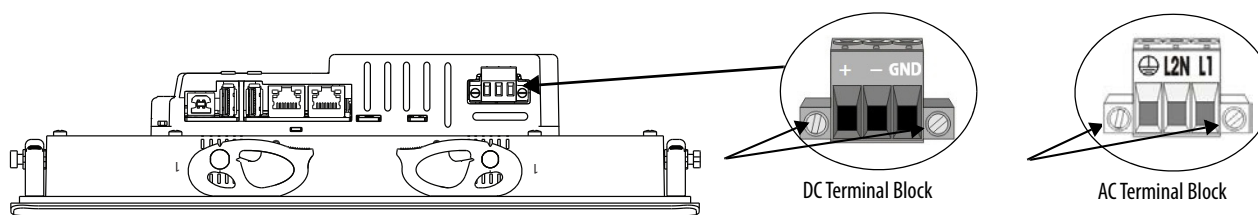

2. Gently pull the terminal block away from the connector.

To install the terminal block, follow these steps.

1. Reattach the terminal block to the connector until seated.



ATTENTION: Do not use excessive force to press the terminal block into position. The terminal blocks are keyed to fit the DC or AC connector. If the terminal block does not fit into the connector, verify that you have the correct terminal block. See [Table 5 on page 17](#).

2. Tighten the two screws that secure the terminal block to the connector.

Connect to DC Power

Terminals with a 24V DC power supply have these power ratings:

- 24V DC nominal (18...30V DC)
- 50 W maximum (2.1 A at 24V DC)



ATTENTION: The power supply is internally protected against reverse polarity. If you connect DC+ or DC- to the earth ground terminal, you can damage the terminal. If you connect AC power, or more than 30V DC, you can also damage the terminal.

Terminals with a DC power input require a safety extra low voltage (SELV) or protective extra-low voltage (PELV) 24V DC power supply. Supported power supplies include catalog numbers 1606-XLP95E, 1606-XLP100E, or 2711P-RSACDIN.



ATTENTION: Use a SELV or PELV supply as required by local wiring codes for your installation. The SELV and PELV power sources provide protection so that under normal and single fault conditions, the voltage between conductors and earth ground does not exceed a safe value.

You can power the terminal from the same power source as other equipment by using a DC power bus.

To connect the operator terminal to a DC power source, follow these steps.

1. Verify that the wiring is not connected to a power source.
2. Strip 7 mm (0.28 in.) of insulation from the ends of the wires.

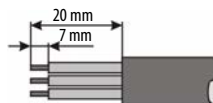

3. Secure the DC power wires to the marked terminals (+ and -) on the terminal block.

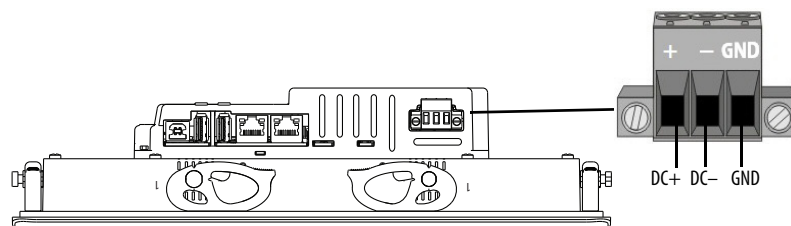

4. Secure the earth ground wire to the GND terminal on the terminal block.

The GND terminal must be connected to a low-impedance earth ground.



ATTENTION: The earth ground connection to ground is mandatory. This connection is required for noise immunity, reliability, and Electromagnetic Compliance (EMC) with the European Union (EU) EMC Directive for CE marking conformance. This connection is required for safety by Underwriters Laboratory (UL).

5. Apply power to the operator terminal.

Connect to AC Power

Terminals with an AC power supply have these power ratings:

- 100...240V AC (50...60 Hz)
- 105VA maximum



ATTENTION: Improper wiring of the power terminals can result in voltage at the communication connector shells.

Do not apply power to the terminal until all wiring connections have been made. Failure to do so can result in electrical shock.

To connect the operator terminal to an AC power source, follow these steps.

1. Verify that the wiring is not connected to a power source.
2. Strip 7 mm (0.28 in.) of insulation from the ends of the wire.

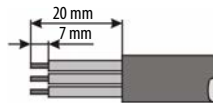

3. Secure the AC power wires to the marked terminals (L1 and L2N) on the terminal block.

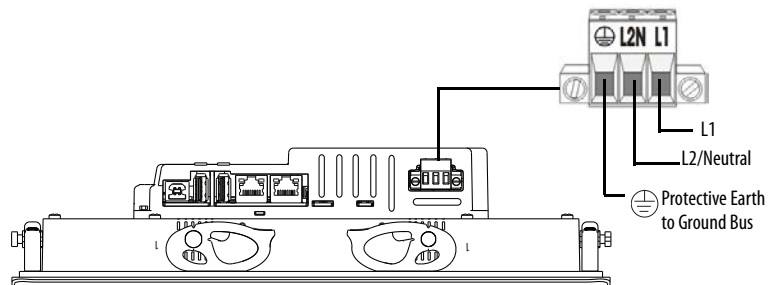

4. Secure the protective earth ground wire to the marked terminal on the terminal block.

The protective earth terminal must be connected to a low-impedance earth ground.



ATTENTION: The earth ground connection to ground is mandatory. This connection is required for noise immunity, reliability, and Electromagnetic Compliance (EMC) with the European Union (EU) EMC Directive for CE marking conformance. This connection is required for safety by Underwriters Laboratory (UL).

5. Apply power to the operator terminal.

Connect to a Network

The two Ethernet ports connect to controllers on an EtherNet/IP™ network by standard Ethernet connections. These network topologies are supported:

- [Device Level Ring Network Topology](#)
- [Linear Network Topology](#)
- [Star Network Topology](#)

Each of these EtherNet/IP network topologies supports applications that use Integrated Motion over an EtherNet/IP network, if necessary.

IMPORTANT The terminal has dual-Ethernet ports but one device IP address.



Ethernet Ports

The Ethernet ports have two 10/100Base-T connectors for network communication and supports MDI/MDI-X connections and DLR network topology.

The terminal connects to an EtherNet/IP network by using a CAT5, CAT5E, or CAT6 twisted-pair, Ethernet cable with RJ45 connectors.

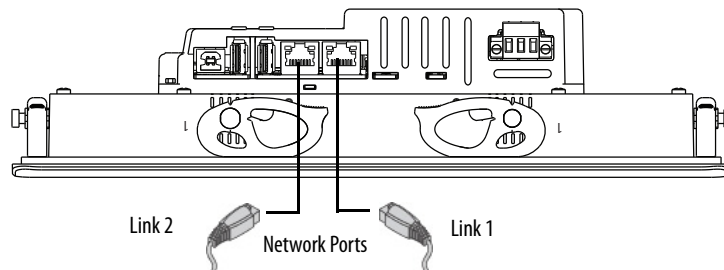

IMPORTANT To help prevent accidental disconnection of the Ethernet cable:

- To minimize vibration at the connector, and reduce the chance that personnel that work inside the panel can accidentally disconnect the cable, secure the Ethernet cable to the connector.
 - Do not install the Ethernet cable too tightly. To prevent pulling on the cable when the panel door is opened and closed, leave some slack in the cable.
-

The maximum cable length between the Ethernet ports and a 10/100Base-T port on an Ethernet switch (without repeaters or fiber) is 100 m (328 ft).



WARNING: In hazardous locations, do not connect or disconnect any communication cable with power applied to this device or any device on the network. An electric arc can cause an explosion in hazardous location installations. Make sure that the power is off or the area is nonhazardous before proceeding.

Table 15 - Ethernet Connector Pinout

Connector	Pin	Pin Name
<p>View of RJ45 Connector</p> <p>1 8</p> <p>Green Indicator Yellow Indicator</p>	1	TD+
	2	TD-
	3	RD+
	4	Unused
	5	Unused
	6	RD-
	7	Unused
	8	Unused
	Shield Connection	No direct connection (AC coupled to chassis GND)

Each Ethernet port has two indicators that provide the activity status.

Table 16 - Ethernet Status Indicators

Indicator	Color	Description
Link Integrity	Green	On, when a link is present.
Activity	Yellow	Blinks when activity is detected on Ethernet link.

Device Level Ring Network Topology

A Device Level Ring (DLR) network is a single-fault tolerant ring network that is intended for the interconnection of automation devices. This topology is also implemented at the device level. No additional switches are required.

TIP A DLR network contains supervisor nodes and ring nodes. The PanelView 5500 terminal operates only as a ring node on the network.

When a fault occurs, the fault location is determined and the supervisor reconfigures the network to continue sending data on the network. Once the fault is corrected, the supervisor reconfigures the network to operate as a normal ring (versus a faulted ring).

For more information on DLR network topology, see EtherNet/IP Embedded Switch Technology Application Guide, publication [ENET-AP005](#).

Figure 6 - PanelView 5500 Terminal in a DLR Topology Network

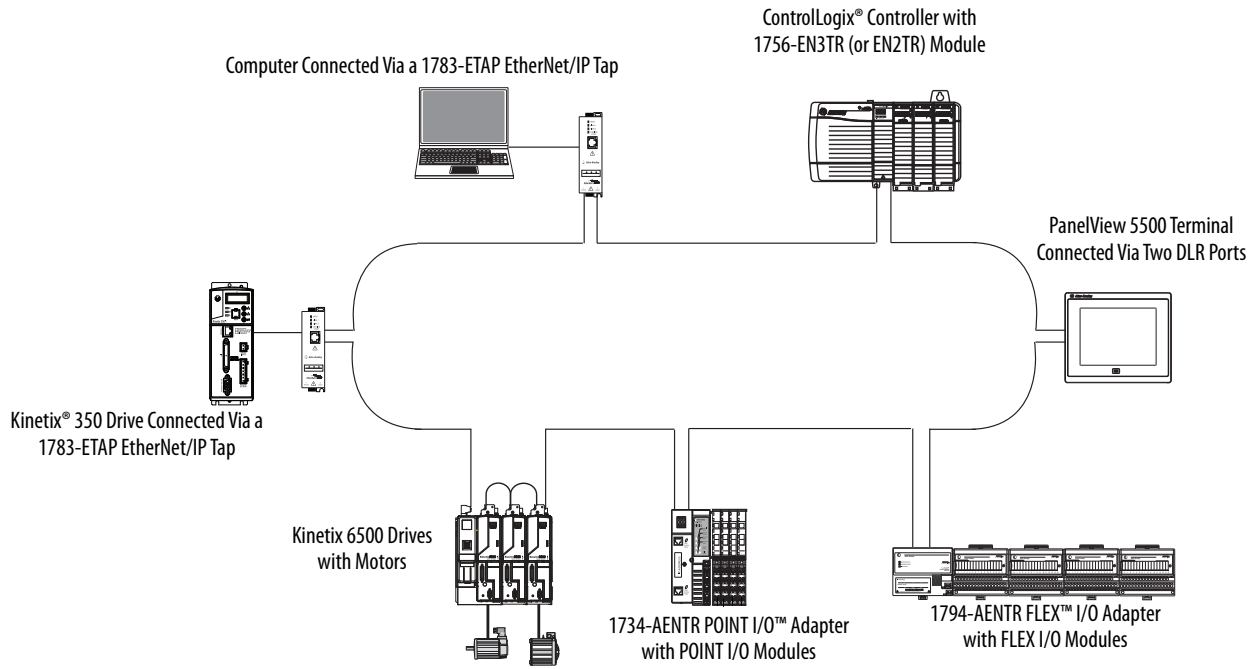

Linear Network Topology

A linear network topology is a collection of devices that are daisy-chained together across an EtherNet/IP network. Devices that can connect to a linear network topology use embedded switch technology to eliminate the need for a separate switch, as required in star network topologies.

Figure 7 - PanelView 5500 Terminal in a Linear Topology Network

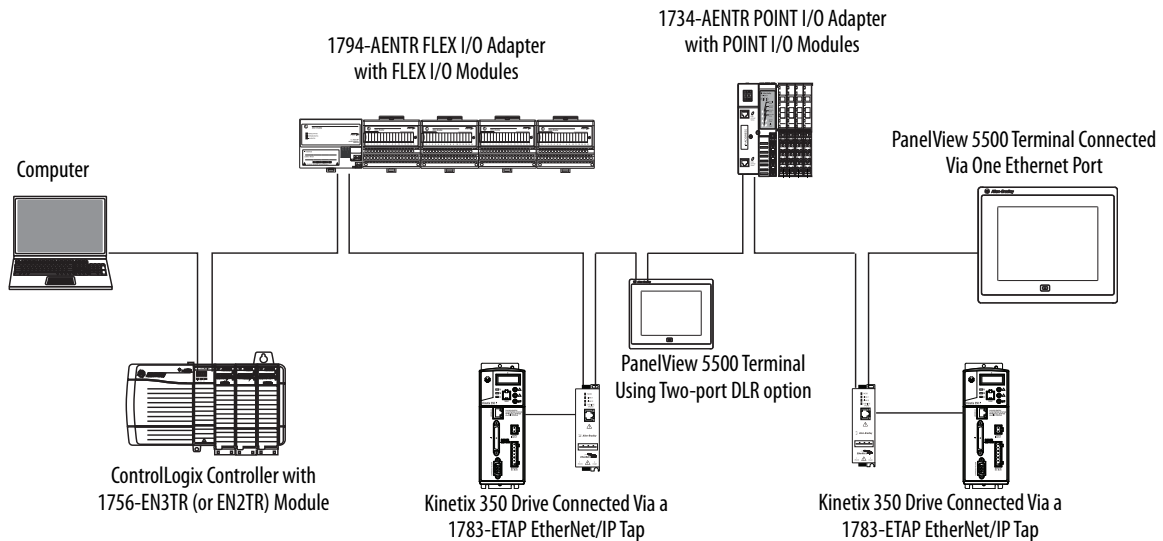

Star Network Topology

A star network topology is a traditional EtherNet/IP network that includes multiple devices that are connected to each other via an Ethernet switch.

Figure 8 - PanelView 5500 Terminal in a Star Topology Network

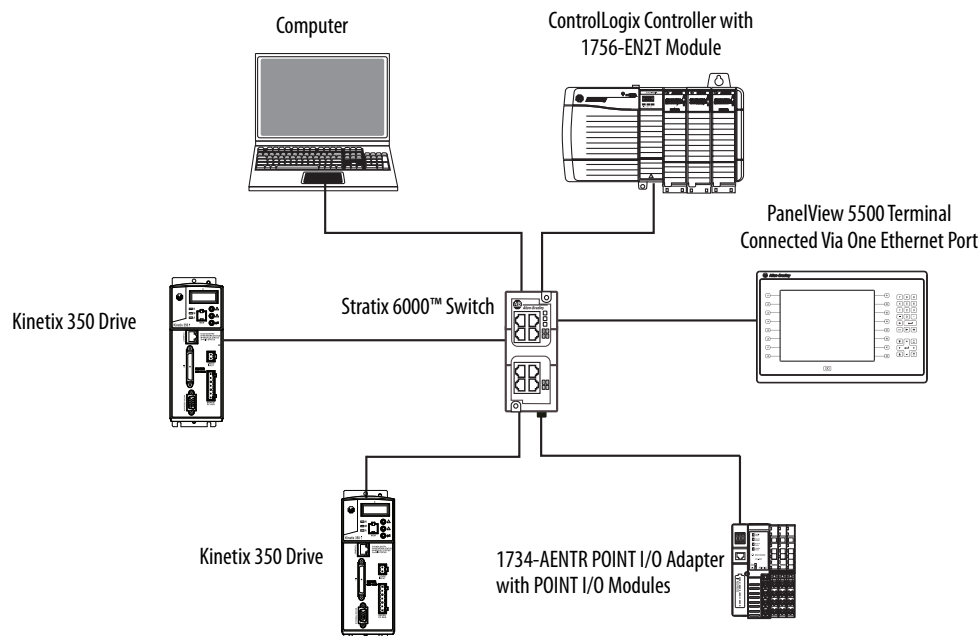

Initial Startup

IMPORTANT You must configure the Ethernet settings and update the firmware before you can download a View Designer project and use the terminal. See [Update the Firmware Before You Use the Terminal on page 42](#).

If you attempt to configure the terminal settings without updating the firmware, the Settings menu shows an update firmware message at the bottom of the screen.

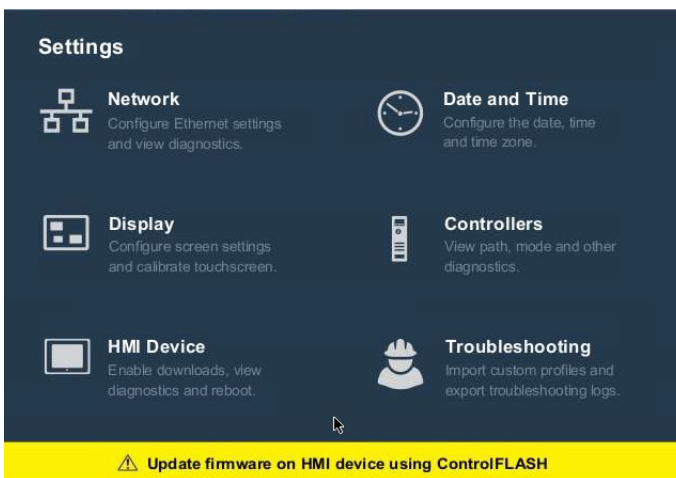

Update the Firmware Before You Use the Terminal

When power is turned on, the terminal goes through its startup sequence. The Welcome screen displays with a Configure the Ethernet Network button.

To configure the Ethernet settings and update the firmware, follow these steps.

1. Boot up the terminal.

The Welcome dialog box displays.

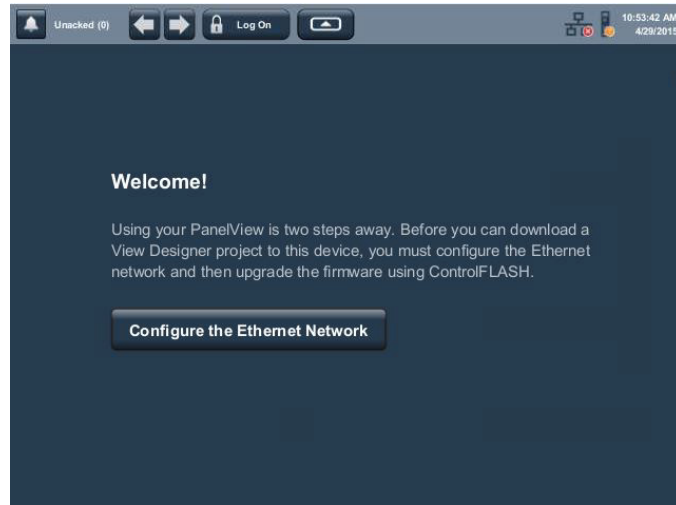

2. Tap Configure the Ethernet Network.

The Internet Protocol (IP) Settings dialog box displays.



3. Configure the IP settings for the terminal.
 - To obtain an IP address automatically, see [Use DHCP to Assign an IP Address For the Terminal on page 52](#).
 - To configure IP settings manually, see [Assign a Static IP Address For the Terminal on page 53](#).

4. Tap the Ethernet icon.
5. Configure the Ethernet ports for the terminal.
See [Configure the Ethernet Ports on page 55](#).

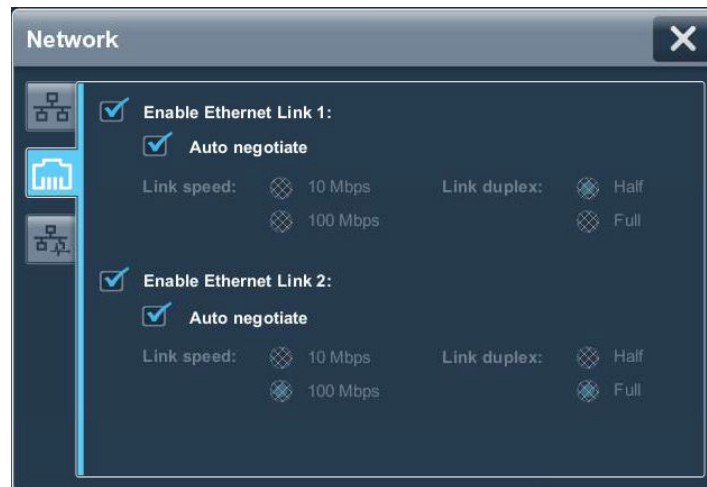

6. Update the firmware by using the ControlFLASH™ software.
Begin the update at [Get the Terminal Firmware on page 88](#).

You can now download a View Designer application to the terminal. After the application is downloaded, the terminal resets then automatically launches the application.

Notes:

Configure Terminal Settings

Topic	Page
Runtime Environment	46
Entering Data Using Virtual Keyboards	47
Log On to the Terminal	49
Log Off of the Terminal	50
Settings Menu	50
Configure the IP Address of the Terminal	52
Configure a DNS Address For the Terminal	54
Configure the Ethernet Ports	55
View the Network Diagnostics	56
Adjust the Brightness of the Display	57

Topic	Page
Configure the Display Screen Saver	58
Calibrate the Touch Screen	59
Disable Downloads to the Terminal	61
Change the HMI Device Name	62
View the Firmware Revision	63
Display Terminal Diagnostics	63
Reboot the Terminal	65
Change the Date and Time	66
View General Information for the Configured Controller	67

Runtime Environment

During runtime, the PanelView™ 5500 terminal runs HMI projects. A project is configured and downloaded to your terminal from the View Designer application. The project launches each time the terminal restarts.

The terminal exchanges data values with the controller, animates the displayed data, and responds when you press keys or touch a screen or element on a screen.

During runtime, you can perform these tasks:

- Navigate screens and their graphic elements
- View and manage alarms
- View and perform operations on a trend chart
- Display error information
- Configure terminal settings and view diagnostic information

Here is an example of a screen in a project that is downloaded to the terminal.



Item	Name	Description
1	Alarm summary	Indicates the number of unacknowledged alarms. Tap the icon to open the alarm summary screen.
2	Previous and next buttons	Tap the left arrow to display the previous screen; tap the right arrow button to display the next screen.
3	Log On	Tap this button to open the Logon dialog box.
4	Navigation button	Tap this button to display the navigation menu at the bottom of the screen.
5	Network diagnostics shortcut	Displays the status of Ethernet link 1 and Ethernet link 2. Tap the icon to open the Network dialog box.
6	Controller diagnostics shortcut	Displays the status of a connected controller. Tap the icon to open the Controllers information screen.
7	Time and date	Displays the current time and date.
8	Screen	Displays screens, shortcuts, and popups of a project that is created in the View Designer application.
9	Navigation menu	Displays menu items that you have access to when you are logged in. To display the navigation menu, press the Navigation button below the screen or in the system banner above the screen. You can tap to menu items to open the screens of the project. Tap a menu item to display that project in the screen. The navigation menu also provides access to the Settings menu for the terminal.

Entering Data Using Virtual Keyboards

The virtual keyboard or virtual numeric keypad opens during runtime when text or numeric input is required.

- The virtual keyboard opens on the PanelView 5500 terminal screen when you tap a field or element that requires text or numeric input.
- The virtual numeric keypad opens on the PanelView 5500 terminal screen when you tap a field or element that requires only numeric input.

Figure 9 - Virtual Keyboard

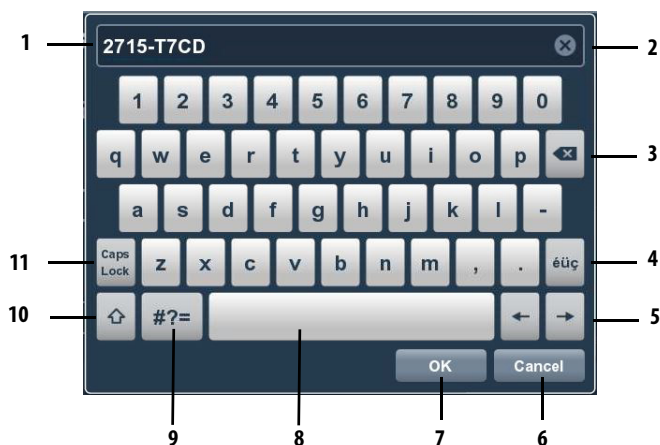

Table 17 - Virtual Keyboard Description

Item	Feature	Description
1	Text entry field	Tap the letters, numbers, and character keys to enter text into this field. The text entry field is always active when the keyboard is open.
2	Clear	Tap this button to remove all characters that are entered in the text entry field.
3	Backspace	Tap this key to delete one character to the left at a time.
4	éüç	Tap this key to toggle between Roman characters and alpha-European characters. Numeric keys are not part of the alpha-European keyboard.
5	Arrow keys	Tap the left arrow key to move the cursor one space to the left. Tap the right arrow key to move the cursor one space to the right.
6	Cancel	Tap Cancel to cancel the entry.
7	OK	Tap OK to complete the entry.
8	Space bar	Tap the space bar to enter a space in the text entry field.
9	#?= ABC	Tap this key to toggle between symbols and alpha-numeric characters: <ul style="list-style-type: none"> • When in symbol mode, the key displays as ABC. • When in alpha-numeric mode, the key displays as #?=.
10	Shift	Tap this key to toggle the keyboard between uppercase and lowercase letters. The keyboard returns to lowercase characters after one character has been entered.
11	Caps lock	Tap this key to toggle the keyboard between uppercase or lowercase letters. The keyboard remains in the selected state until you tap this key again.

Figure 10 - Virtual Numeric Keypad

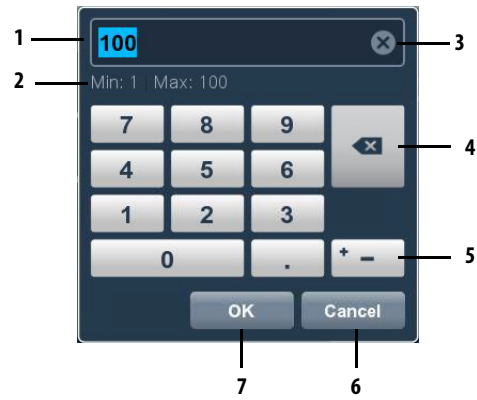

Table 18 - Virtual Numeric Keypad Description

Item	Feature	Description
1	Numeric entry field	The numeric entry field into which you type the numeric value for the graphic element.
2	Min-Max value	The displayed minimum and maximum values you can enter for the selected field or element.
3	Clear	Tap the X to remove all numbers that are entered into the numeric entry field.
4	Backspace	Tap the backspace button to delete one number to the left at a time.
5	+ _	Tap the positive-negative value button to toggle between a positive or negative number.
6	Cancel	Tap Cancel to cancel the entry.
7	OK	Tap OK to complete the entry.

Log On to the Terminal

When you log on to the terminal, the screens that you have security access to appear as items in the navigation menu. For example, if you have been assigned the administrator role, all screens that have administrator access appear in the navigation menu.

- TIP**
- The Guest user is logged on automatically at system startup. Anyone that is not logged on to the system can view or access only those screens assigned the level of security that is given to the Guest user account.
 - Screen security and user roles are assigned in Studio 5000 View Designer® and cannot be modified on the PanelView 5500 terminal.

To log on to the terminal, follow these steps.



1. In the system banner at the top of the screen, tap Log On.

The Logon dialog box opens.

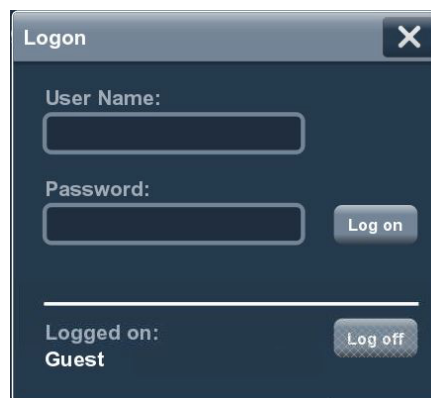

2. Tap the User Name field.
The virtual keyboard opens.
3. To enter your user name with no spaces, tap the keys.
4. Tap OK.
5. Tap the Password field.
The virtual keyboard opens.
6. To enter your password with no spaces, tap the keys.
Passwords are case-sensitive.
7. Tap OK.
8. Tap Log on.

The Logon dialog box closes and your user name appears on the Log On button on the status banner.

- TIP**
- You can only be logged on as one user at a time.
 - If you are already logged on to the terminal, you can log on as another user. Open the Log On dialog box, enter another user name and password, then tap Log On.

Log Off of the Terminal

When you log off, the following actions occur:

- The Guest user is logged in by default.
- If the Guest user has access to the current screen, the terminal continues to display the current screen.
- If the Guest user does not have access to the current screen, the Home screen for the project is displayed.

To log off the terminal, follow these steps.

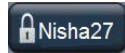

1. In the status banner at the top of the screen, tap the Log On button that is showing your user name.

The Logon dialog box opens.

2. Tap Log off.

You are logged off the terminal.

Settings Menu

You can access configuration parameters and system-wide information for the terminal from the Navigation menu.

To open the Settings menu, follow these steps.



1. Press the navigation button on the terminal.



2. Tap Settings, or tab to the menu item and press Enter.

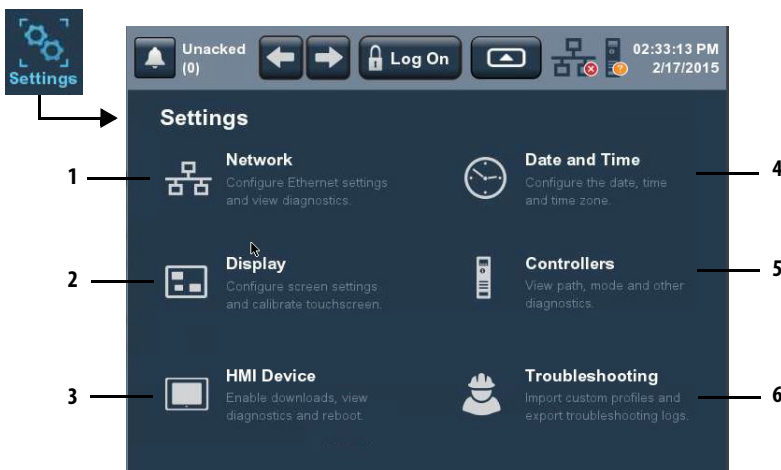

Item	Menu Topic	Tasks That You Can Perform
1	Network	<ul style="list-style-type: none"> • Configure a static or dynamic device IP address • Configure Ethernet Link 1 and Ethernet Link 2 settings • View network diagnostics
2	Display	<ul style="list-style-type: none"> • Adjust the brightness of the display • Enable or disable the screen saver • Configure the screen saver settings • Calibrate the touch screen
3	HMI Device	<ul style="list-style-type: none"> • Enable or disable downloads and firmware updates • Enter an HMI device name • View the catalog number and current firmware revision • View terminal diagnostic information • Reboot the terminal
4	Date and Time	<ul style="list-style-type: none"> • Set the date and time on the terminal • Set the time zone on the terminal
5	Controllers	<ul style="list-style-type: none"> • View general information for the controller • View diagnostic information for the controller
6	Troubleshooting	<ul style="list-style-type: none"> • Select a default or imported profile for troubleshooting • Save the troubleshooting log to a USB drive or SD card for Rockwell Automation technical support

Configure the IP Address of the Terminal

You can configure the IP address of the terminal to use the Dynamic Host Configuration Protocol (DHCP), or manually configure a static IP address.

A project is downloaded to the terminal from the View Designer application through the IP address of the terminal.

TIP You cannot configure network IP addresses within the View Designer software.

Use DHCP to Assign an IP Address For the Terminal

In a DHCP configuration, the network assigns the IP address, subnet mask, and default gateway address fields.

To configure DHCP for the terminal, follow these steps.



1. Press the navigation button on the terminal.
2. Tap Settings, or tab to the menu item and press Enter.



3. Tap Network.



4. Tap the Obtain IP settings automatically using DHCP radio button.
5. To close the window, tap X.

Assign a Static IP Address For the Terminal

To assign a static IP address for the terminal, follow these steps.



1. Press the navigation button on the terminal.
2. Tap Settings, or tab to the menu item and press Enter.



3. Tap Network.
4. Tap the Manually configure IP settings radio button.



Follow these guidelines to assign the IP Settings Configuration.

Parameter	Description
IP address	The range of values for the first set of numbers is 1...255. The range of values for last three sets of numbers is 0...255
Subnet mask	The subnet mask address must be identical to server subnet mask.
Gateway address	Optional address.

5. Tap the IP address field.
The virtual keyboard opens.
6. To enter the IP address, use the virtual keyboard.
7. Tap OK to close the virtual keyboard.
8. Repeat steps 5...7 for the subnet mask and the Gateway address fields.
9. To close the window, tap X.

Configure a DNS Address For the Terminal

The domain name system (DNS) translates internet domain and host names to IP addresses. DNS automatically converts a name that is typed in a web browser address bar to the IP addresses of web server that host that site. You can configure DNS addresses for common domain or host names.

TIP You cannot configure DNS addresses within the View Designer software.

To configure a DNS address for the terminal, follow these steps.



1. Press the navigation button on the terminal.
2. Tap Settings, or tab to the menu item and press Enter.



3. Tap Network.
4. Tap the Manually configure IP settings radio button.

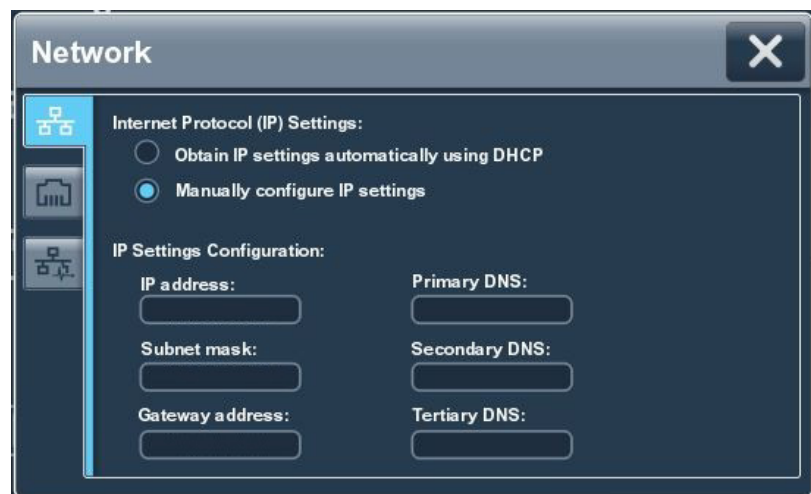

Follow these guidelines to assign the DNS settings.

Parameter	Description
Primary DNS	The range of values for this address is 0...255
Secondary DNS	The range of values for this address is 0...255
Tertiary DNS	The range of values for this address is 0...255

5. Tap the Primary DNS field.
The virtual keyboard opens.
6. To enter the DNS address, use the virtual keyboard.
7. Tap OK to close the virtual keyboard.
8. Repeat steps 5...7 for the Secondary DNS and the Tertiary DNS fields.
9. To close the window, tap X.

Configure the Ethernet Ports

You can configure the link speed and duplex mode for each of the Ethernet ports on the terminal. The ports are identified as Ethernet Link 1 and Ethernet Link 2.

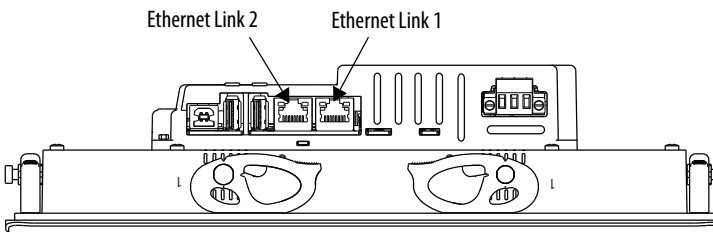

TIP You cannot configure the Ethernet ports within the View Designer software.

To view or change the link settings of the Ethernet ports, follow these steps.



1. Press the navigation button on the terminal.
2. Tap Settings, or tab to the menu item and press Enter.



3. Tap Network.
4. Tap the Ethernet icon.

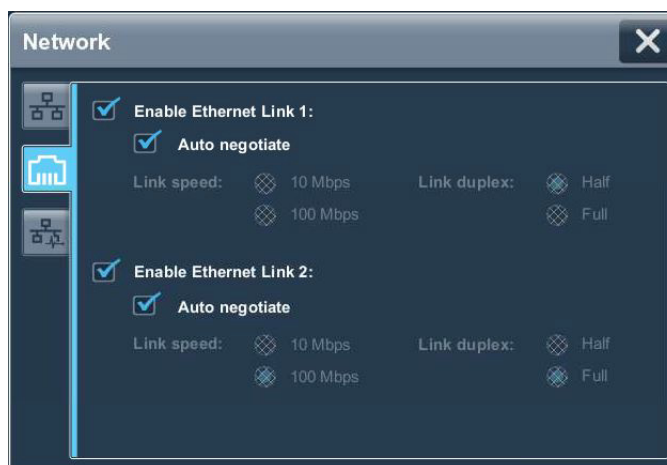

5. Select the Ethernet options for your network configuration:
 - Tap the Enable Ethernet Link 1 or Enable Ethernet Link 2 checkbox to add or remove the check mark. The option is enabled when the box is checked.

IMPORTANT For DLR configurations, Ethernet Link 1 and Ethernet Link 2 must be enabled.

- To set the speed and duplex options that are based on the network connection, tap the Auto negotiate checkbox. The option is enabled when the box is checked.
 - To set the speed and duplex options, tap the Auto negotiate checkbox to remove the check mark from the box. Then tap the speed and duplex options for your network.
6. To close the window, tap X.

View the Network Diagnostics

From the Network Diagnostics screen, you can view Ethernet Link 1 and Ethernet Link 2 network connection data, network status data, and IP settings configuration data.

To view the Network Diagnostics screen, follow these steps.



1. Press the navigation button on the terminal.
2. Tap Settings, or tab to the menu item and press Enter.



3. Tap Network.
4. Tap the network diagnostic icon.

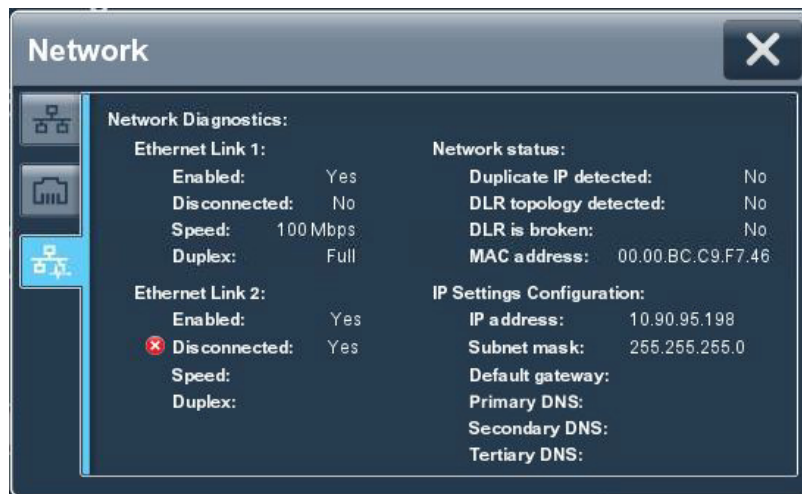

5. Tap X to close the window.

Adjust the Brightness of the Display

You can adjust the brightness level of the terminal display in increments from 1...100%.

- 1% is the minimum display visibility.
- 100% is the maximum display visibility.

TIP Lower the brightness level to reduce the power that the backlight consumes, and extend the life of the backlight.

These tags can also be set to control backlight brightness level:

::Local:HMIDevice.Display.BacklightIntensity

::Local:HMIDevice.Display.ScreenSaverIntensity

To adjust the brightness of the display, follow these steps.



1. Press the navigation button on the terminal.

2. Tap Settings, or tab to the menu item and press Enter.



3. Tap Display.

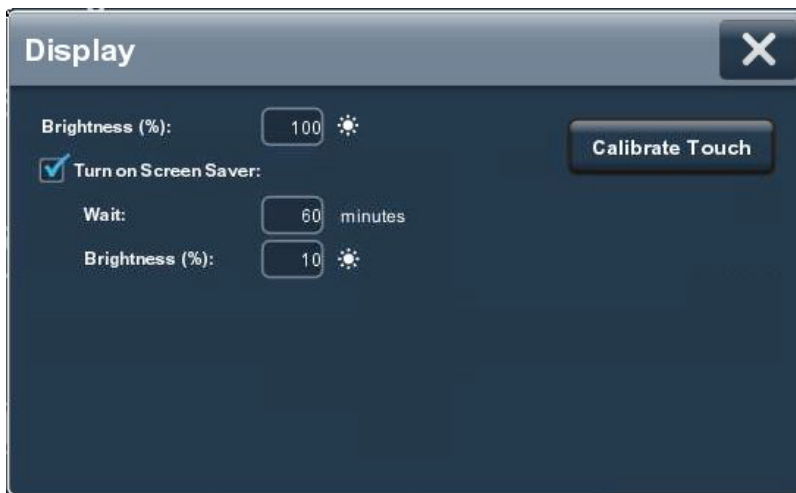

4. Tap the Brightness field.

The virtual numeric keypad opens.

5. Enter the value for the brightness in increments from 1...100%.

6. Tap OK.

7. To close the window, tap X.

Configure the Display Screen Saver

The screen saver extends the life of the backlight by dimming the brightness level when activity is not sensed for a specified amount of time. When the screen saver is activated, the terminal displays a moving image at a reduced brightness level. When user input is sensed, the screen saver is deactivated and the display brightness returns to its configured level.

TIP After the screen saver is deactivated, touch or keypad input is ignored for at least 0.5 seconds.

To configure the brightness and screen saver for the display, follow these steps.



1. Press the navigation button on the terminal.
2. Tap Settings, or tab to the menu item and press Enter.



3. Tap Display.

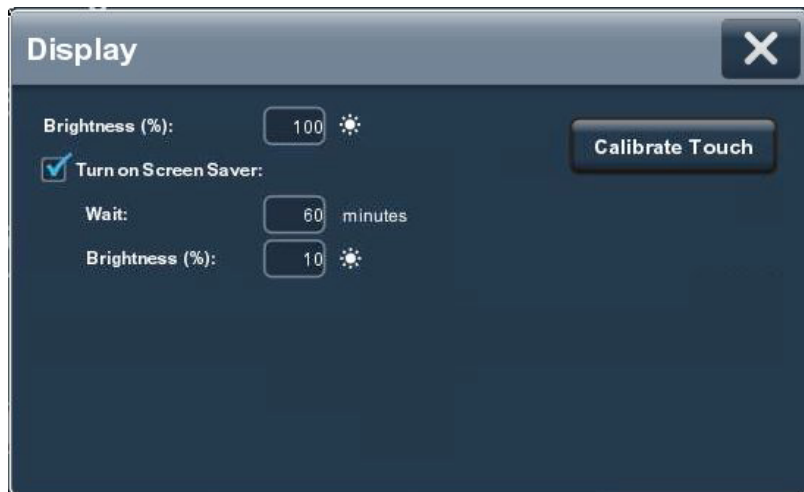

4. Tap the checkbox next to Turn on Screen Saver to add or remove the check mark. The option is enabled when the box is checked.
5. Tap the Wait field.

The virtual numeric keyboard opens.

6. Enter the number of continuous, idle minutes from 1...5999 to wait before activating the screen saver.

The default is 10 minutes.

7. Tap OK.

8. Tap the Brightness (%) field.

The virtual numeric keyboard opens.

9. Enter the value for the brightness in increments from 1...100%.

10. Tap OK.

11. To close the window, tap X.

Calibrate the Touch Screen

The touch screen is calibrated at the factory. After installation, you can recalibrate the touch screen to compensate for parallax if the screen is viewed at an angle.

The calibration process requires you to touch a series of targets on the screen.

IMPORTANT For accuracy and to prevent damage to the touch screen, use a plastic stylus device with a minimum tip radius of 1.3 mm (0.051 in.).

To calibrate the touch screen, follow these steps.



1. Press the navigation button on the terminal.
2. Tap Settings, or tab to the menu item and press Enter.



3. Tap Display.



4. Tap Calibrate Touch.

A red target appears on the screen.

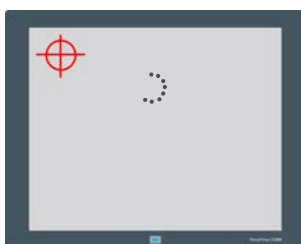

5. Press and hold the center of the target until the target completes the circle.

The next target appears.

TIP Touch inside the target areas before the progress indicator completes a circle.

6. Continue to press and hold the centers of all remaining targets as they appear.

All processed targets are replaced with white targets.

A green circle with a check indicates a successful calibration.



A red circle with an X indicates a failed calibration.

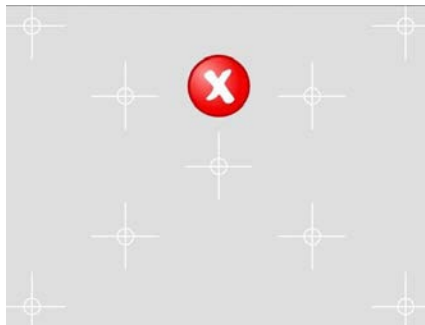

If the calibration fails, the process automatically repeats. Continue the calibration until the calibration is successful.

TIP The calibration is retained after a reset or power cycle.

Disable Downloads to the Terminal

As a security measure, you can disable downloads to the terminal, including application downloads and firmware updates. Disable downloads to prevent the current application from being replaced when an application is downloaded from the View Designer application.

To disable downloads to the terminal, follow these steps.



1. Press the navigation button on the terminal.
2. Tap Settings, or tab to the menu item and press Enter.



3. Tap HMI Device.



4. Tap the Allow Downloads and Firmware Updates checkbox to clear the checkbox.
 - Downloads are not permitted when the checkbox is cleared.
 - Downloads are permitted when the checkbox is checked.
5. To close the window, tap X.

While this setting is unchecked, you cannot download another application to the terminal or update the terminal firmware.

Attempts to download an application from the View Designer application results in an error.

Change the HMI Device Name Each terminal has a unique default HMI device name that identifies it to other devices on the network. You can view or change this name.

To view or change the HMI device name, follow these steps.



1. Press the navigation button on the terminal.

2. Tap Settings, or tab to the menu item and press Enter.



3. Tap HMI Device.

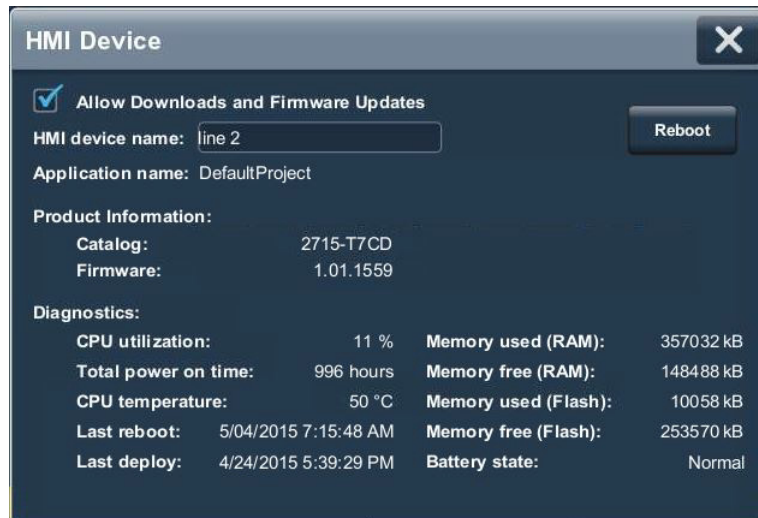

The HMI device name field shows the current name.

4. Tap the HMI device name field.

The virtual keyboard opens.

5. To enter or modify the current name, tap the virtual keyboard keys.

- TIP**
- You can enter up to 15 characters including letters, numbers, and hyphens.
 - The first character of the terminal name must be an upper or lowercase letter.

6. Tap OK.

7. To close the window, tap X.

View the Firmware Revision

You can view the current firmware revision on the terminal. You need this information for firmware updates, or when you call technical support.



1. Press the navigation button on the terminal.
2. Tap Settings, or tab to the menu item and press Enter.



3. Tap HMI Device.



View the firmware revision under Product Information.

4. To close the window, tap X.

Display Terminal Diagnostics

To view the diagnostic data for the terminal, follow these steps.



1. Press the navigation button on the terminal.
2. Tap Settings, or tab to the menu item and press Enter.



3. Tap HMI Device.

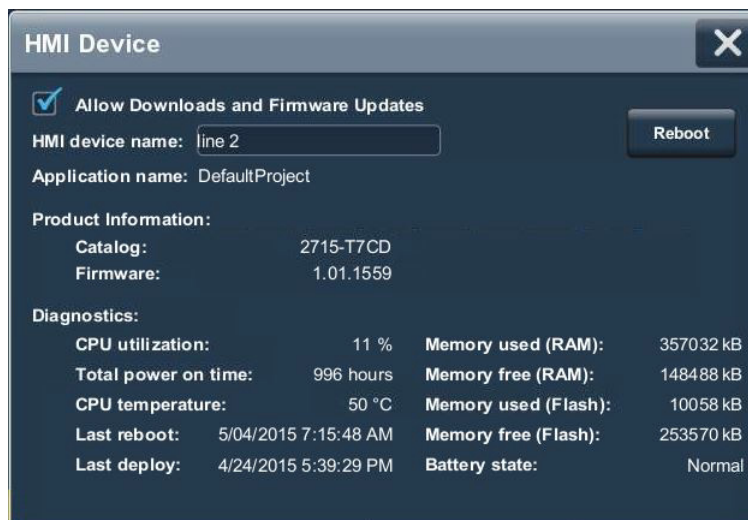

4. View the information under Diagnostics.

Diagnostic Parameter	Description
CPU utilization	The processor usage.
Total power on time	The total time the terminal has been running (powered).
CPU temperature	Displays the current temperature of the CPU: <ul style="list-style-type: none"> • Normal: 25...94 °C (77...201 °F) • High: 100 °C (212 °F) and higher An over-temperature condition of 105...110 °C (221...230 °F) causes a delayed automatic system restart. The restarts continue indefinitely until the system is cool enough to resume normal operation.
Last reboot	Displays the date and time for the most recent reboot of the terminal.
Last deploy	Displays the date and time of the most recent project application download.
Memory used (RAM)	The total RAM memory that is in use.
Memory free (RAM)	The total RAM memory that is remaining.
Memory used (Flash)	The total nonvolatile memory that is in use.
Memory free (Flash)	The total nonvolatile memory that is remaining.
Battery state	<ul style="list-style-type: none"> • Normal • Low • Depleted

5. To close the window, tap X.

Reboot the Terminal

To reboot the terminal, follow these steps.



1. Press the navigation button on the terminal.
2. Tap Settings, or tab to the menu item and press Enter.



3. Tap HMI Device.

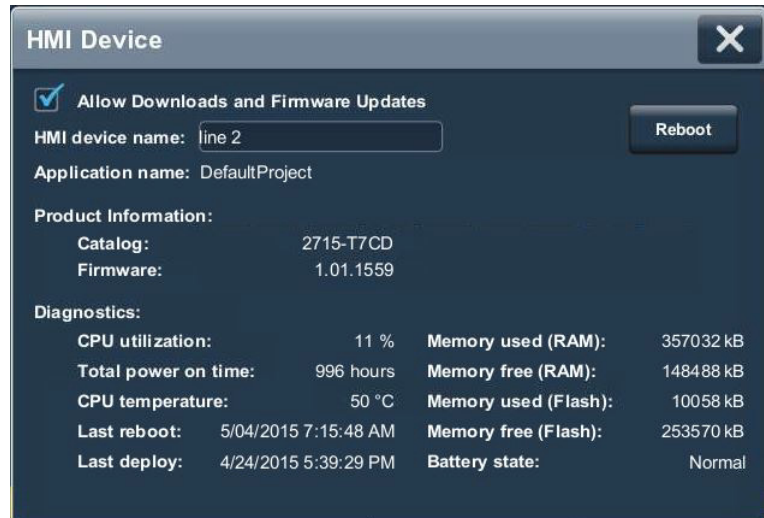

4. Tap Reboot Terminal.

You are prompted to confirm the reboot.

5. To reboot the terminal, tap Yes.

If you tap Yes to reboot the terminal, it restarts and displays the project that is downloaded to the terminal.

To cancel, tap No.

Change the Date and Time

You can change the date and time that is used for terminal operations. The date and time is displayed on the terminal screen and recorded in log files. You can also change the time zone for the terminal.

To change the date and time that is used for terminal operations, follow these steps.



1. Press the navigation button on the terminal.
2. Tap Settings, or tab to the menu item and press Enter.



3. Tap Date and Time.

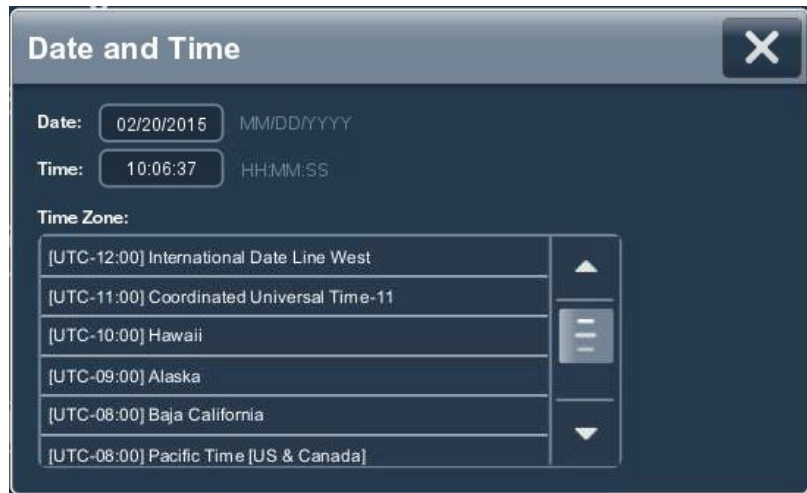

4. Change the Date and Time fields as appropriate.
 - a. Tap a Date or Time field.
The virtual keyboard opens.
 - b. Enter a value and tap OK.

Date and Time Parameters		Valid Values
Date MM/DD/YYYY Enter the date format including the '/' characters.	Year	Up to 2999
	Month	1...12
	Day	0...31
Time HH:MM:SS (24-hour format) Enter the time format including the ':' characters.	Hour	0...23
	Minute	0...60
	Second	0...60

5. Change the time zone, if desired.
 - a. To move up and down the list, press and drag the scroll bar (or press and hold an arrow button).
Or tab to the list and use the arrows keys on the physical keypad of the terminal.
 - b. Tap the time zone for the terminal.
The time on the terminal is adjusted to match the selected time zone.
6. To close the window, tap X.

View General Information for the Configured Controller

You can view general information for the controller that is configured to operate with the terminal.

To view the general information for the controller, follow these steps.



1. Press the navigation button on the terminal.
2. Tap Settings, or tab to the menu item and press Enter.
3. Tap Controllers.



The general information for the controller includes these data.

Data Type	Description
Reference	The name of the controller reference that is configured in the View Designer application. The name does not appear if a controller is not configured for the project.
Path	The communication path for the controller. The path does not appear if a controller is not configured for the project.
Controller name	The name of the controller that is configured in the Logix Designer application. The name does not appear if a controller is not configured for the project.
Tag information	The synchronization state to process changes from the controller. For example, the state can be Synchronized, Updating, or Detecting changes. Some tag information cannot appear if the controller tag information is not synchronized (UNINITIATED).
Mode	The operating mode of the controller. For example, the mode can be Run, Program, or Fault. The mode does not appear if the controller is disconnected from the network.
Catalog	The Catalog number of the controller. The catalog number does not appear if the controller is disconnected from the network.
Firmware	The major and minor revision numbers for the firmware in the controller. The firmware revision numbers do not appear if the controller is disconnected from the network.

4. To close the window, tap X.

Notes:

Monitor and Manage Control System Alarms

Topic	Page
Alarm Indicator	69
Alarm Help Menu	70
View the Alarm Summary	72
Manage the Alarms	73
Alarm Detail-pane Descriptions	74
Filter the Alarms	76

Alarm Indicator



The Unacked icon in the system banner displays the number of unacknowledged alarms for the system.

Tap the Unacked icon to open the alarm summary and view the system alarms.



Alarm Help Menu

To view a brief description of the alarm function keys and status counts, follow these steps.

1. Open the Alarm Summary ([page 72](#)) or Alarm Manager ([page 73](#)) screen.
2. Tap the Help icon.



The Help window displays a brief description of the alarm function keys and status counts.

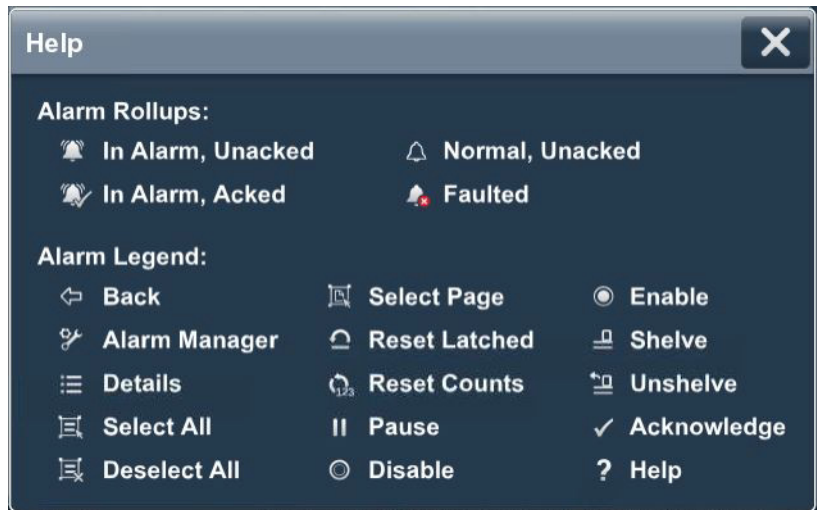













3. Tap X to close the window.

See [Table 19 on page 70](#) for a detailed description of the alarm function keys and alarm status counts.

Table 19 - Alarm Function-key Descriptions

Symbol	Function Key or Message	Description
	Acknowledge	Indicates that you are aware of the alarm. This button changes the state of the alarm from unacknowledged to acknowledged.
	Alarm Manager	Opens the alarm manager screen. The alarm manager lists all alarms that are configured in the system and their current states. Therefore, the alarm manager shows alarms that are not shown in the alarm summary, and provides additional tasks for alarms.
	Back	Opens the previously displayed screen. When you open the alarm manager screen from the alarm summary screen, this button reopens the alarm summary screen.
	Deselect All	Deselects all alarms in the alarm table, including the alarms that are not displayed on the current page of alarms.
	Details	Hides or shows the details pane, which contains the details of the last selected alarm. The details pane appears on the bottom half of large alarm tables and replaces the list of alarms in medium alarm tables. If no alarm is selected, the details pane is empty.
	Disable	Stops the alarm condition from being evaluated. In effect, turns off the selected alarm. You can only disable an entire alarm. You cannot disable an individual alarm condition.

Table 19 - Alarm Function-key Descriptions (Continued)

Symbol	Function Key or Message	Description
	Enable	Enables the selected alarms in the alarm manager table, which allows the alarm condition to be evaluated, which turns on the alarm. An enabled alarm enables all conditions for that alarm. You cannot enable an individual alarm condition.
	Faulted	Provides a count of the alarms in a faulted state.
	Help	Provides a description of the help buttons and alarm status.
	In Alarm, Acked	Provides a count of the alarms in an acknowledged state.
	In Alarm, Unacked	Provides a count of the alarms in an unacknowledged state.
	Normal, Unacked	Provides a count of the alarms where the input of the alarm has returned to normal, but the alarm has not yet been acknowledged.
	Pause	Stops updates to the alarm summary table for 10 seconds, or until another operation is performed on the table. While updates to the alarm summary table are paused, alarms in the controller are still evaluated. When the table is no longer paused, any changes to alarm states are reflected in the table and updates resume.
	Reset Counts	Resets the alarm count in the controller and the alarm count value in the details pane of the alarm manager table to zero. The reset is performed for all conditions of the currently selected alarm.
	Reset Latched	Sets the selected digital latched state of the alarm to normal if the input of the alarm has returned to normal. A reset of a digital latched alarm acknowledges the alarm, if it is not acknowledged.
	Select All	Selects all alarms in the alarm table, including the alarms that are not displayed on the current page of alarms.
	Select Page	Selects all alarms that are displayed on the current page of alarms.
	Shelve	Prevents the notification of new state changes to the selected alarm if the alarm is acknowledged. Updates to the alarm do not appear. The alarm remains shelved until the shelf duration from the controller expires automatically or you unshelve the alarm manually. Updates to the alarm then resume. When you shelve an alarm in the alarm summary table, you shelve only the selected alarm conditions. When you shelve an alarm in the alarm manager table, you shelve all conditions of the alarm. From the condition list in the details pane of the alarm manager table, you can also shelve individual alarm conditions.
	Unshelve	Unshelves the selected alarm in the alarm manager table, which allows notification of new state changes to alarms. From the condition list in the details pane of the alarm manager table, unshelve individual alarm conditions.

View the Alarm Summary

The alarm summary lists alarms that are in alarm or out of alarm but still unacknowledged. It displays one alarm condition per row. Use the alarm summary to monitor and interact with alarms.

To view the alarm summary for the control system, follow these steps.



1. Press the navigation button on the terminal.

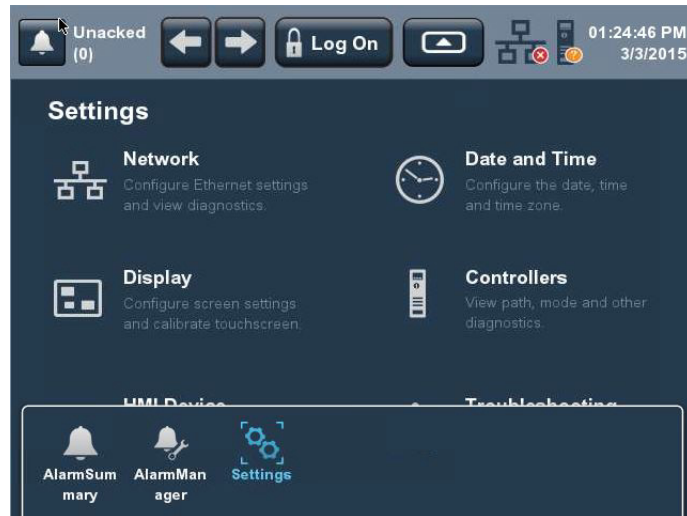

3. Tap Alarm Summary, or tap to the menu item and press Enter.

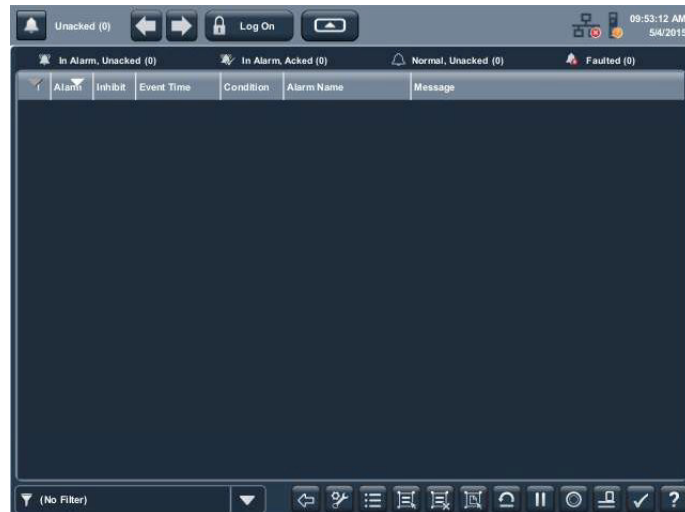

4. Tap the alarm function keys to view the alarms.
See [Alarm Help Menu on page 70](#) for a description of the keys.
5. To return to the navigation menu, tap the navigation button on the terminal.
6. To return to the application screens, tap an application icon.

Manage the Alarms

The Alarm Manager lists all alarms that are configured in a system and their current states.

To manage the alarms for the control system, follow these steps.



1. Press the navigation button on the terminal.

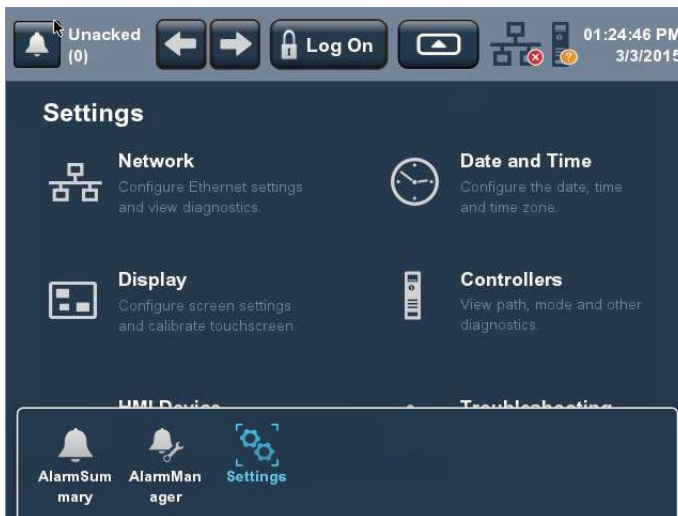

3. Tap Alarm Manager, or tab to the menu item and press Enter.

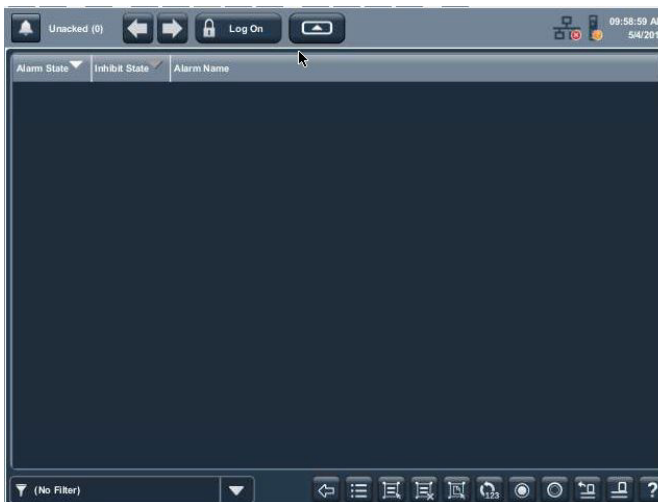

4. Tap the alarm function keys to manage the alarms.
See [Alarm Help Menu on page 70](#) for a description of the keys.
5. To return to the navigation menu, tap the navigation button on the terminal.
6. To return to the application screens, tap an application icon.

Alarm Detail-pane Descriptions

The details pane shows details for the selected alarm condition of a selected alarm. Condition details display the selected alarm condition in the alarm manager table.

To view the details pane for a selected alarm, follow these steps.

1. Open the Alarm Summary ([page 72](#)) or Alarm Manager ([page 73](#)) screen.
2. Tap the Details icon.



The details pane displays a list of alarm states and conditions.

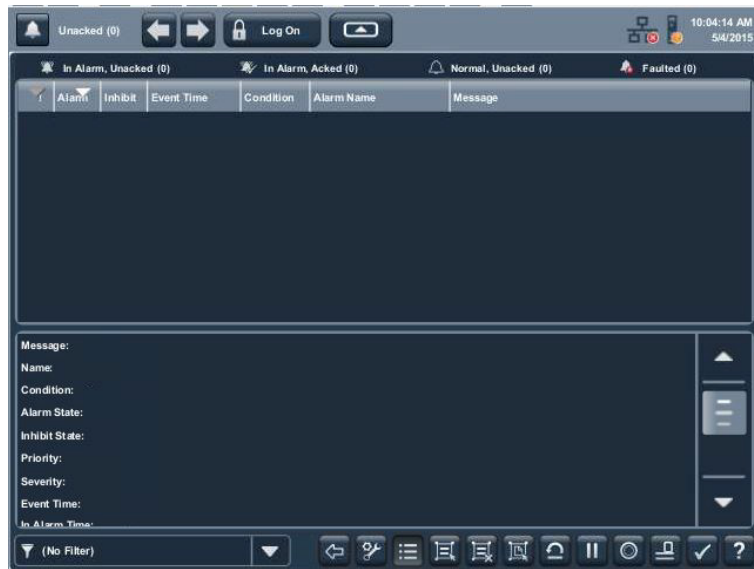





Tap the Details icon again to toggle off the details pane.

See [Table 20](#) for a description of the alarm details.

Table 20 - Alarm Detail Descriptions

Alarm Detail	Description
Acknowledge Time	The time the selected alarm was acknowledged.
Alarm Class	The user-defined class that is assigned to the alarm in the Logix Designer project.
Alarm Count	The number of times the alarm condition has entered the In Alarm state.
Alarm State	The state of the alarm condition: <ul style="list-style-type: none"> • Normal Unacknowledged • In Alarm Acknowledged • In Alarm Unacknowledged • Normal Acknowledged
Condition	<ul style="list-style-type: none"> • Analog conditions include: HIHI, HI, LO, LOLO, ROC_POS, and ROC_NEG • Discrete conditions include: TRIP and TRIP_L
Current Value	The current tag input value that results in the alarm state.
Disable Time	The time the selected alarm was disabled.
Enable Time	The time the selected alarm was enabled.
Event Category	<ul style="list-style-type: none"> • Digital events are categorized as discrete. • Analog events are categorized as level.

Table 20 - Alarm Detail Descriptions (Continued)

Alarm Detail	Description
Event Time	The date and time the alarm event occurred.
In Alarm Time	The time the selected alarm entered the In Alarm state.
Inhibit State	<p>The value that is applied to the alarm condition that inhibits the alarm at some level. These states, indicated by an icon in the alarm table, include:</p> <ul style="list-style-type: none"> • Bad Quality  • Disabled  • Suppressed  • Shelved  <p>These states can be combined. When an alarm has multiple inhibit states that are applied, the icon of the highest inhibit state appears in the table.</p>
Limit Value Exceeded	The condition limit that is assigned to the alarm in the Logix Designer project.
Max Shelve Duration	The maximum time the alarm can be shelved.
Message	The message that is assigned to the alarm in the Logix Designer project.
Name	<p>The name of the alarm. This name includes the controller name of the alarm and the tag name. It can also include the name of the program if the tag is defined at the program level. Therefore, the alarm name can be configured in these configurations:</p> <p>::ControllerName.TagName Or ::ControllerName\ProgramName.TagName</p>
Out of Alarm Time	The time the selected alarm entered the Normal or Inactive state.
Priority	<p>The urgency of the alarm condition:</p> <ul style="list-style-type: none"> • Low • Medium • High • Urgent
Quality	The list of reasons why the alarm is of bad quality. This field is blank in the alarm summary because the alarm summary does not show bad quality alarms.
Severity	<p>The numeric value that is mapped to the assigned priority of the alarm condition:</p> <ul style="list-style-type: none"> • 1...250 (low) • 251...500 (medium) • 501...750 (high) • 751...1000 (urgent)
Shelve Duration	The default time for which the selected alarm condition is shelved to prevent the notification of new state changes. Shelve duration is assigned to the alarm in the Logix Designer project.
Shelve Time	The time the selected alarm was shelved.
Suppress Time	The time the selected alarm was suppressed.
Tag 1 Value	The value of the associated tag parameter 1.
Tag 2 Value	The value of the associated tag parameter 2.
Tag 3 Value	The value of the associated tag parameter 3.
Tag 4 Value	The value of the associated tag parameter 4.
Unshelve Time	The time the selected alarm was unshelved. If the alarm is shelved, this time is the time that the alarm is unshelved automatically when the shelve duration expires.
Unsuppress Time	The time the selected alarm was unsuppressed.

Filter the Alarms

You can filter the alarms to view only the alarms in the selected alarm state.

To filter the alarms, follow these steps.



1. Tap the filter pull-down arrow.

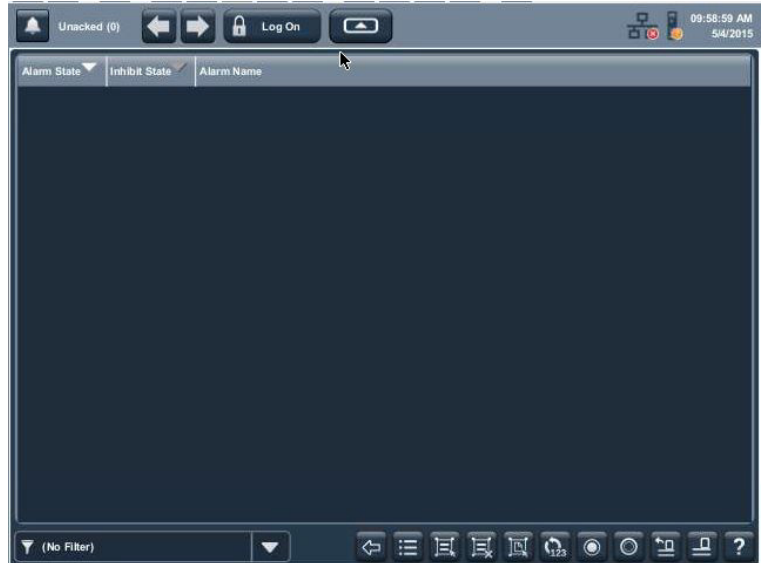

2. Tap the up or down arrows on the scroll bar to scroll through the filter choices
3. Tap the alarm filter that you want to use.

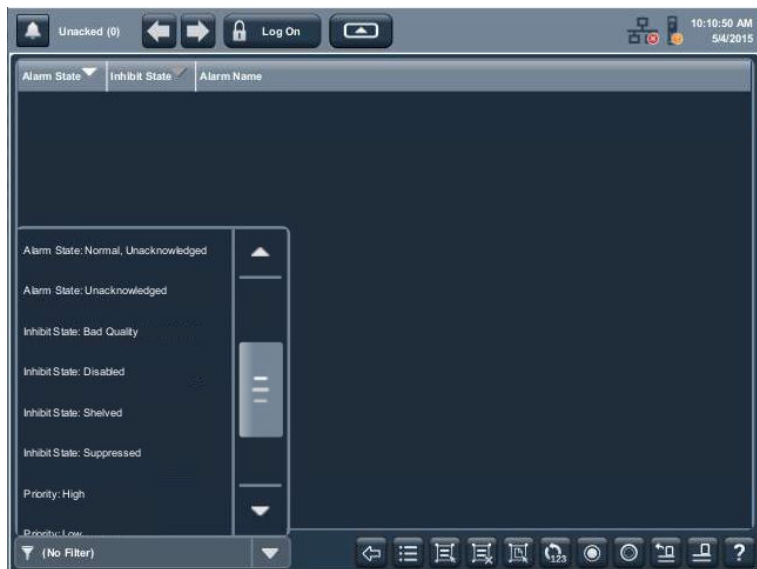

The selected filter displays in the filter pull-down menu.

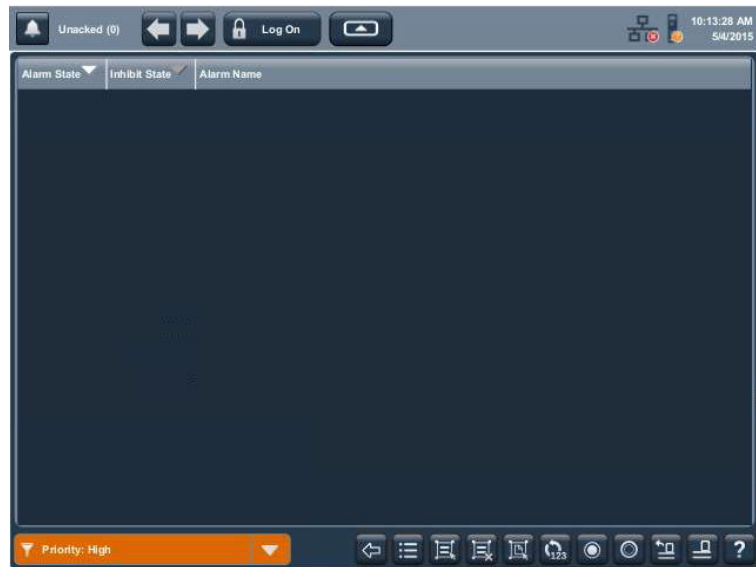

To change the filter, tap the filter pull-down menu and select another filter. To turn off the filter, tap No Filter.

Notes:

Install and Replace Components

Topic	Page
Connect to USB Ports	80
Insert an SD Card	81
Replace the Battery	82
Install a Protective Overlay	84

**ATTENTION: Prevent Electrostatic Discharge (ESD)**

This equipment is sensitive to electrostatic discharge, which can cause internal damage and affect normal operation.

Follow these guidelines when you handle this equipment:

- Touch a grounded object to discharge potential static.
- Wear an approved grounding wriststrap.
- Do not touch connectors or pins on component boards.
- Use a static-safe workstation, if available.



ATTENTION: Disconnect all power before you install or replace any components. Failure to disconnect power can result in electrical shock or damage to the terminal.



At the end of its life, collect this equipment separately from any unsorted municipal waste.

Connect to USB Ports

The terminals have two USB 2.0 (type A) host ports. The USB host ports support removable USB flash drives.

IMPORTANT The USB device port is not functional. Do not use the USB device port.



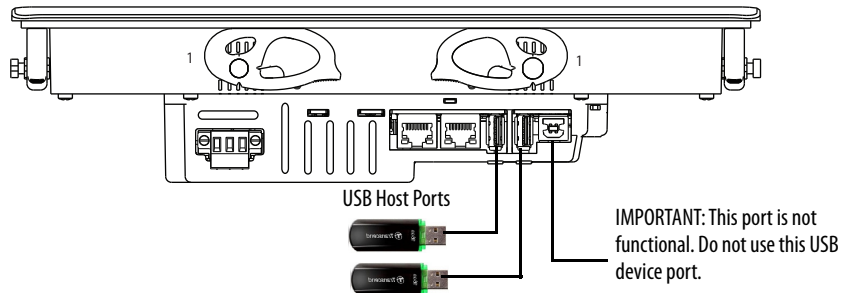

IMPORTANT See [page 22](#) for information on the USB host ports and USB peripheral devices in hazardous locations.

IMPORTANT The USB host connections can be used with an external keyboard and mouse during runtime operations, and are intended for temporary use.



Icons identify the USB host connections. The USB host connection supports 0.5 A at 5V DC. Connected USB devices must not exceed this power load.

Table 21 - USB Connector Pinout

USB Port	USB Icon	USB Connector	Pin	Signal	Description
Host			1	VCC	+5V
IMPORTANT: This port is not functional. The port will be available in a future software release.			2	D-	Data -
			3	D+	Data +
			4	GND	Ground



ATTENTION: USB devices that are not powered by the USB port must be within the same enclosure as the terminal. The USB devices must be connected to a ground system common with the terminal or used with a USB hub that provides galvanic isolation.

Connect only externally powered USB hubs to the terminal that are USB 2.0 compatible. Before you attach devices to a USB hub, make sure that the power adapter is connected and powered on.

USB Cables

Use only hi-speed, USB 2.0 certified cables for error-free transmissions.

IMPORTANT The terminals have not been tested with USB 3.0 cables. We recommend only the use of USB 2.0 certified cables.

Insert an SD Card

The SD card can only be used to load troubleshooting profiles and to save troubleshooting logs. Supported cards include catalog numbers 1784-SD1 and 1784-SD2. The SD cards are hot-swappable; they can be inserted and removed while the terminal is powered on and in use.



WARNING: Explosion Hazard

In hazardous location installations, if you remove or insert an SD card while the power is on, an electric arc can occur. An electric arc can cause an explosion in hazardous location installations. If the terminal is installed in a hazardous location, do not remove and insert the SD card unless power has been removed or the area is known to be nonhazardous.

The SD card slot is accessible from the inside or back of the panel when the operator terminal is installed.

To install an SD card in the card slot, follow these steps.

1. Verify that the SD card is locked or unlocked according to your preference.
 - If unlocked, the terminal can write data to or read data from the card.
 - If locked, the terminal can only read data from the card.

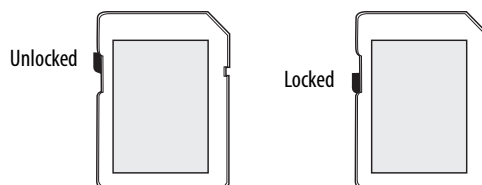

ATTENTION: Orient the SD card correctly before inserting into slot. If you force the card into the slot, you can damage the card or the terminal.

2. Insert the SD card firmly into the slot until you hear a click.

When you hear the click, the card has locked into place.

To remove the card, push the card in slightly to unlock the SD card so you can remove it from the slot.

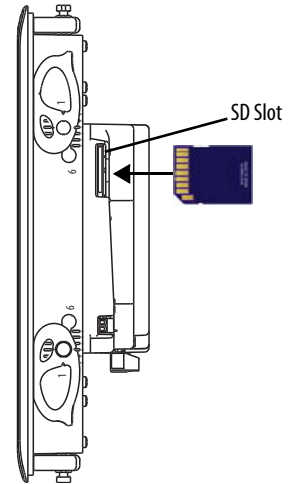

Replace the Battery

The product has a lithium battery that provides back-up power for the real-time clock. The battery can be replaced while the product is mounted in the panel. You need a #1 Phillips screwdriver (#1 Phillips bit) to remove the logic module and access the battery.



This product contains a sealed lithium battery, which may need to be replaced during the life of the product.

At the end of its life, the battery contained in this product should be collected separately from any unsorted municipal waste.

The collection and recycling of batteries helps protect the environment and contributes to the conservation of natural resources as valuable materials are recovered.



WARNING: There is a danger of explosion if the lithium battery in this product is incorrectly replaced. Do not replace the battery unless power has been removed and the area is known to be nonhazardous.

Replace the battery only with catalog number 2711P-RY2032 or an equivalent CR2032 coin-cell battery.

Do not dispose of the lithium battery in a fire or incinerator. Dispose of used batteries in accordance with local regulations.

For safety information on the handling of lithium batteries, including handling and disposal of leaking batteries, see Guidelines for Handling Lithium Batteries, publication [AG 5-4](#).

Perchlorate material – special handling may apply. See www.dtsc.ca.gov/hazardouswaste/perchlorate.

This perchlorate warning only applies to primary Lithium Manganese Dioxide (LiMnO²) cells or batteries, and products containing these cells or batteries, sold or distributed in California, USA.

To replace the battery, follow these steps.

1. Disconnect power from the terminal.
2. Loosen the screws that secure the logic module to the back of the display.

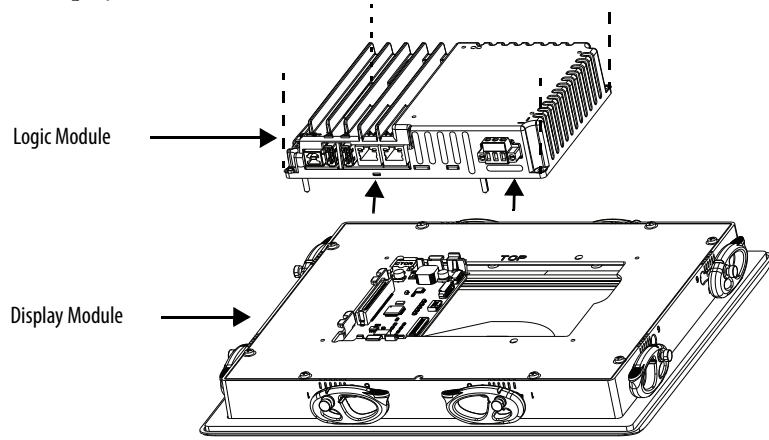

This equipment is sensitive to electrostatic discharge (ESD).
Follow ESD prevention guidelines when handling this equipment.

3. Carefully lift the logic module away from the display module and turn over to expose the circuit board.
4. Locate the coin-cell battery on the circuit board.

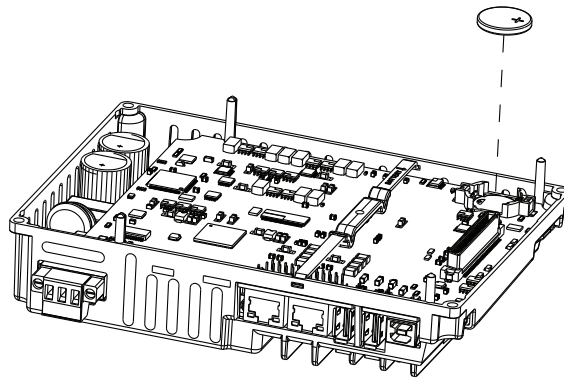

5. Remove the battery by lifting on the side of the battery.
6. Insert the new battery with the positive (+) polarity up.
7. Reattach the logic module by aligning the connector on the bottom of the logic module with the connector on the back of the display module.

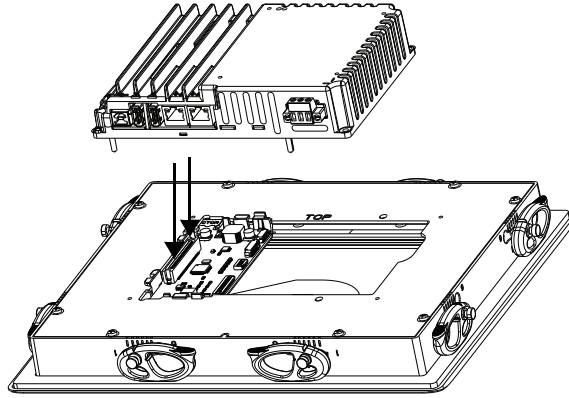

8. Push down on the logic module and make sure that it is fully seated.
9. Tighten the screws to a torque of 0.68...0.90 N•m (6...8 lb•in).

Install a Protective Overlay

The overlay protects the touch screen and keys from scratches, dust, fingerprints, and external damage from chemicals or abrasive materials. See [Table 4 on page 17](#) for a list of available overlays.

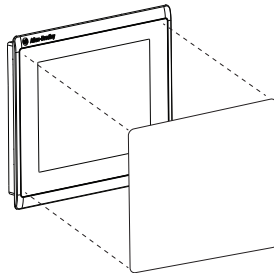

The protective overlay covers the entire surface of the terminal bezel inside the aluminum perimeter. The overlay has a protective liner that is removed by pulling back on a tab. Do not remove the liner until you are ready to install the overlay.

IMPORTANT Follow these guidelines when installing the overlay:

- Make sure that your hands are clean and dry.
 - Handle the overlay by its edges to prevent fingerprints or lint. If you do get marks or lint on the overlay, remove them before proceeding.
 - Do not touch the adhesive ring.
-

Before installing the overlay, clean the touch screen and keys, if present, by using a lint-free cloth and a mild glass cleaner. Remove all fingerprints, grease, or dust. Marks that are not removed get trapped underneath the overlay. Grease also affects the adhesion of the overlay.

To apply the protective overlay, follow these steps.

1. Pull the tab from one of the short sides and partially peel the liner away from adhesive layer.

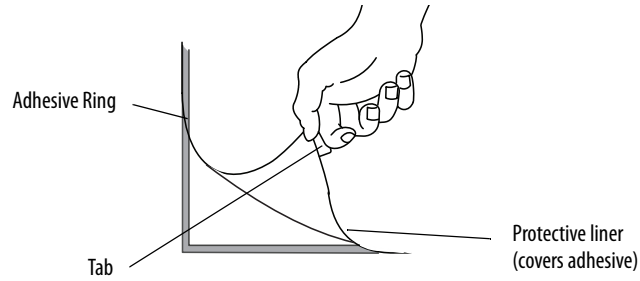

Hold the peeled back portion of the protective liner out of the way as you perform the next step.

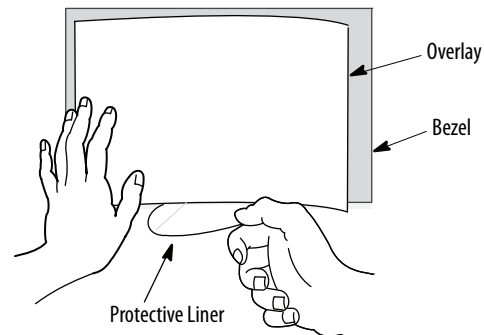

2. Center the overlay over the bezel and carefully position the adhesive surface on the terminal.

While the protective liner is still covering the rest of the overlay, verify that it is properly centered.

3. Slowly peel off the rest of the liner while using a soft cloth to press the overlay on the screen.

Make sure that the overlay lies flat with no bubbles or warps.

4. With a soft cloth or finger, press around the edges of the overlay to seal it, and remove any air bubbles trapped in the adhesive.

Clean the Overlay

Clean the overlay by using a clean, lint-free cloth, and a mild glass cleaner that leaves no streaks. Windex or an eye glass cleaner is recommended. Avoid cleaners that contain abrasives.

Remove the Overlay

Remove the overlay if it is damaged or needs replacement. Lift a corner and slowly pull off the overlay. Use isopropyl alcohol to remove any residual adhesive. Do not reuse the overlay.

Notes:

Update Firmware

Topic	Page
Before You Begin	87
Firmware Requirements	87
Get the Terminal Firmware	88
Install the ControlFLASH Software	88
Update the Firmware by Using ControlFLASH Software	89
Verify the Firmware Update	91

Before You Begin

Perform these tasks to prepare for the update:

- Verify that RSLinx® Classic software is configured with an Ethernet driver to communicate with the terminal.
- Back up your application files to a computer.
- Verify that downloads to the terminal are allowed. If downloads are disabled, you cannot update the terminal firmware.

See [Disable Downloads to the Terminal on page 61](#) and make sure that downloads are allowed to the terminal.

- Verify the catalog number of your product and the current firmware revision on the terminal.

See [View the Firmware Revision on page 63](#) to get the catalog number and current firmware revision.

Firmware Requirements

ControlFLASH™ software is used to update firmware in the PanelView™ 5500 terminal on the network. The update performs these actions:

- Installs updated binary files
- Preserves configuration data, such as Ethernet settings, display brightness, time and date, and touch screen settings

Use [Table 22](#) to determine requirements for the firmware update.

Table 22 - Firmware Requirements for PanelView 5500 Terminals

Software	Firmware Revision
Studio 5000® that also includes: <ul style="list-style-type: none"> • RSLinx® Classic software • ControlFLASH software 	1.0 or later 3.51.00 or later 12.00.01 or later
PanelView 5500 Terminal firmware	1.0 or later
Know the catalog number of the PanelView 5500 terminal you want to update	
Know the RSLinx network path to the targeted PanelView 5500 terminal	

Get the Terminal Firmware

From the Quick Links list on <http://www.ab.com>, choose Product Compatibility and Download Center.

See the Product Compatibility and Download Center Quick Start Guide, publication [PCDC-QS001](#), for instructions on how to find and download firmware and release notes for the terminal.

Install the ControlFLASH Software

ControlFLASH software is required to update firmware on the PanelView 5500 terminal. This software is included in the Studio 5000® installation package.

For details on how to install ControlFLASH software, see the ControlFLASH Firmware Upgrade Software User Manual, publication [1756-UM105](#).

Update the Firmware by Using ControlFLASH Software

To use the ControlFLASH software to update the firmware in a PanelView 5500 terminal, follow these steps.

1. Click Start>Programs>FLASH Programming Tools>ControlFLASH.

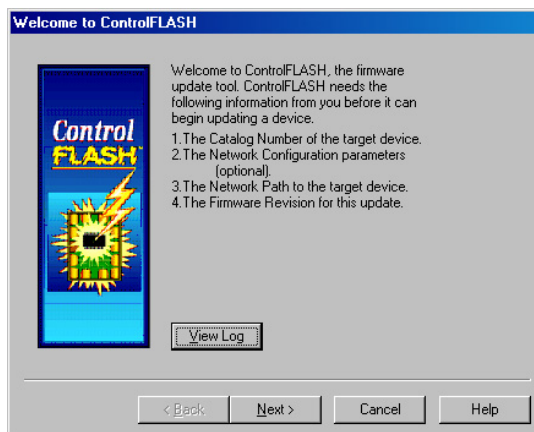

2. Make sure that you know the required information in the Welcome dialog box, then click Next.

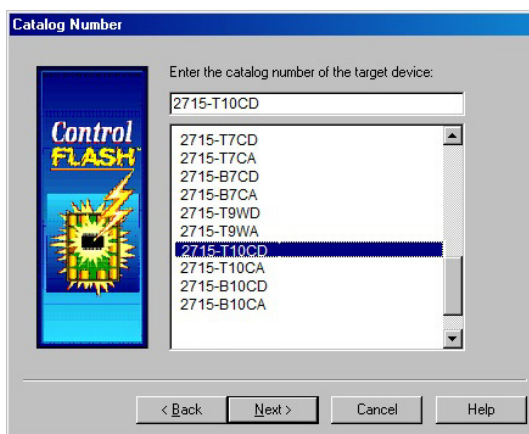

3. Select the catalog number of the PanelView 5500 terminal you want to update and click Next.

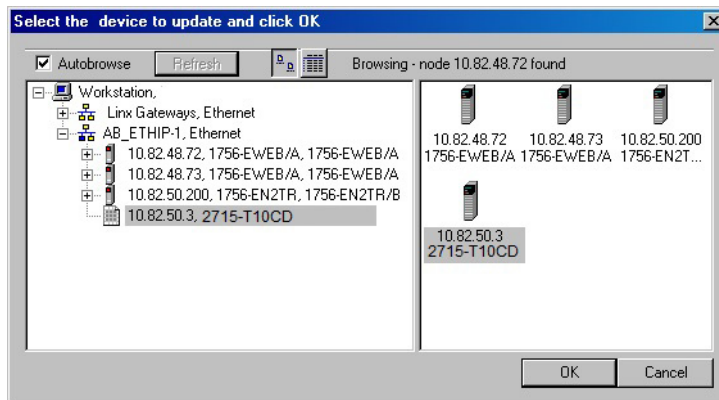

4. Browse to and select the device to update on the EtherNet/IP™ network and click OK.

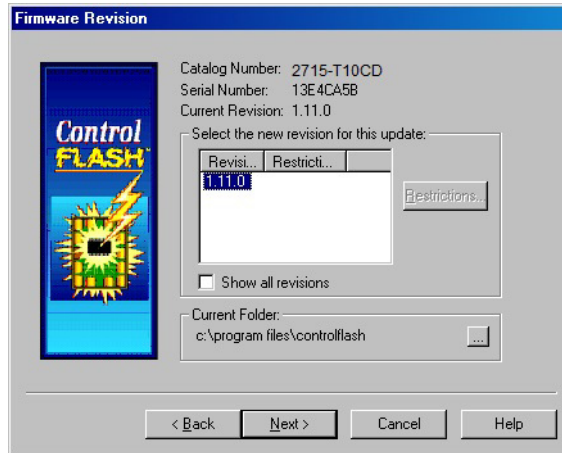

5. Select the firmware revision to install and click Next.

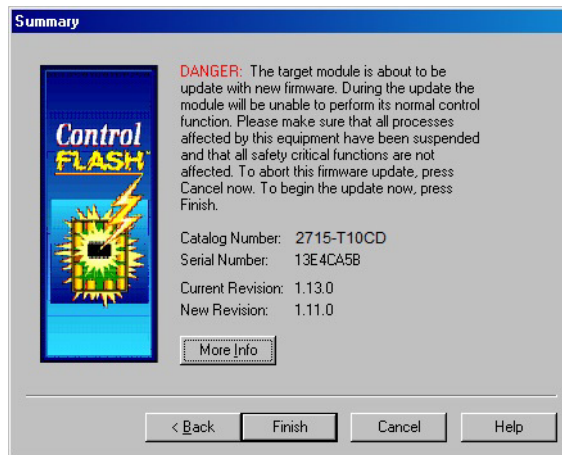

6. Read the Danger information in the Summary dialog, then click Finish.

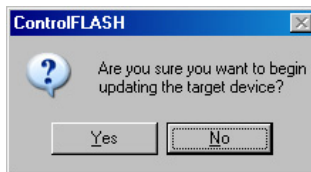

7. Click Yes to confirm that you want to update the target device.

The update starts and can take several minutes to complete.

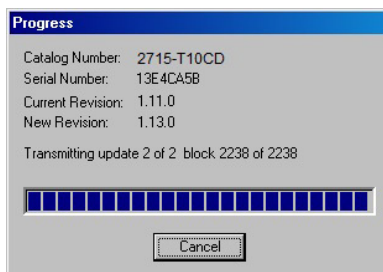

IMPORTANT Do not cycle power to the terminal during this process or the firmware update does not complete successfully.

When the firmware is sent to the terminal, the terminal resets and performs diagnostics.

The Update Status dialog opens when the update is complete. If the update was successful, the Status area is green.

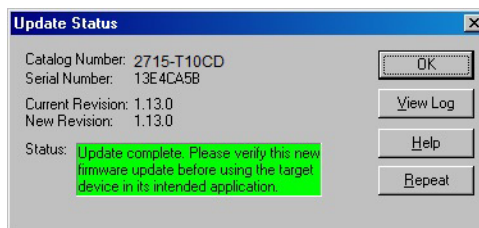

8. Click OK.

If the update fails, the status area is red and reads Update failure. See the ControlFlash firmware update Kit User Manual, publication [1756-UM105](#) for troubleshooting information.

9. Close the ControlFLASH software.

Verify the Firmware Update

See [View General Information for the Configured Controller on page 67](#) to view the current firmware revision for the terminal.

Notes:

Troubleshooting

Topic	Page
Status Indicators	94
View Diagnostic Information for the Configured Controller	95
Troubleshooting Profiles	95
Terminal Does Not Start Up	99
Terminal Restarts Intermittently	99
Touch Screen Issues	99
Display Issues	100
Ethernet Issues	100
Cannot Download Application to Terminal	101
Performance Is Slow	101
Resistance to Chemicals	101
Clean the Display	102
Ship the Terminal	103
Restore Factory Defaults	103

Status Indicators

The back of the terminal has two indicators to identify system status:

- STS indicator (green) indicates that the terminal is on and in use
- ERR indicator (red) indicates hardware and firmware faults

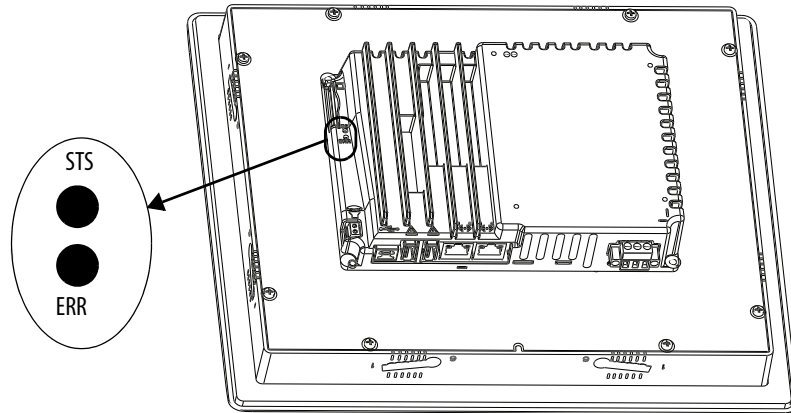

At startup, the STS and ERR indicators blink on and off, then the STS indicator blinks to signal progress during startup. If the indicators remain off, check the power cable.

After a successful startup, the STS indicator remains on.

[Table 23](#) shows indicator states if the terminal stops during startup.

Table 23 - Fault Indicator States during Terminal during Startup

ERR (red) Indicator	STS (green) Indicator	Description	Recommended Action
Blinking	On	Recoverable firmware error.	Reload the firmware.
	Off	Recoverable configuration failure	Restore factory defaults. Refer to Restore Factory Defaults on page 103 .
On	On	Fatal hardware error	Replace the terminal.
	Blinking	Fatal display hardware error	Replace the terminal.

View Diagnostic Information for the Configured Controller

You can view diagnostic information for the controller that is configured to operate with the terminal.

To view diagnostic information for the controller, follow these steps.



1. Press the navigation button on the terminal.
2. Tap Settings, or tab to the menu item and press Enter.



3. Tap Controllers.
4. Tap the diagnostics tab.

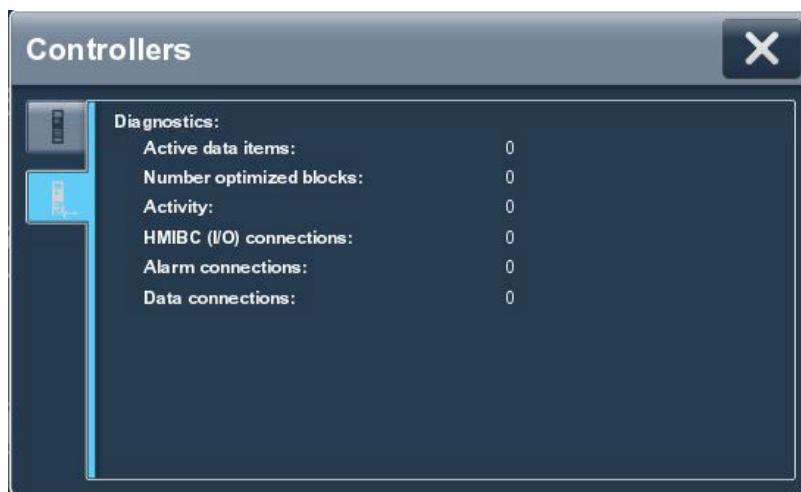

The diagnostic information for the controller includes these data.

Data Type	Description
Active data items	The number of data items on scan for the controller.
Number optimized blocks	The numeric of optimized data blocks on scan for the controller.
Activity	A count that increments each time a communication packet is received from the controller.
HMIBC (I/O) connections	The number of Class 1 Common Industrial Protocol (CIP) connections to the controller.
Alarm connections	The number of alarm CIP connections to the controller.
Data connections	The number of Class 3 CIP connections to the controller.

5. To close the window, tap X.

Troubleshooting Profiles

Rockwell Automation compiles data about your system in a secure, encrypted format. This profile is stored on the terminal and can be used to improve usability and assist with troubleshooting.

If you contact technical support, a representative can ask you to export the troubleshooting log to a USB drive or SD card. You can also import a troubleshooting profile from a USB drive or SD card to capture additional data.

Import a Troubleshooting Profile

The Troubleshooting window indicates whether a default or imported troubleshooting profile is being used in the terminal. If an imported file is in use, a green check mark and the name of the imported file appears next to the Import Profile button.

To import a troubleshooting profile from a USB drive or SD card, follow these steps.



1. Press the navigation button on the terminal.
2. Tap Settings, or tab to the menu item and press Enter.



3. Tap Troubleshooting.
4. Insert a USB drive or SD card that contains the troubleshooting profile into the appropriate slot on the terminal.
5. Tap Import Profile.



6. Tap to select the target USB device or SD card that contains the profile.
7. Tap Save.

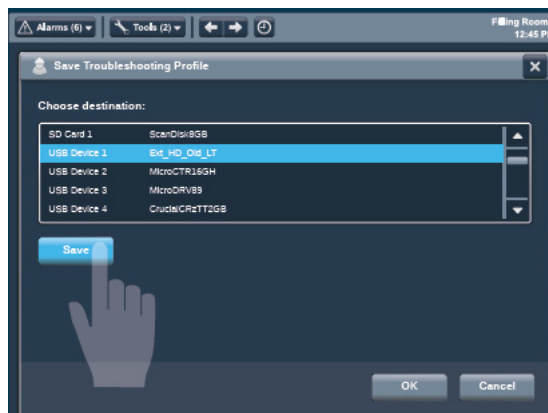

8. To close the window, tap OK.

The name of the imported file is displayed. A green check next to the file name means that the import is complete.

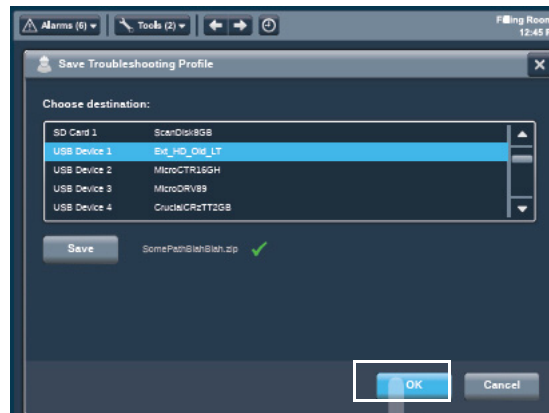

ATTENTION: Do not remove the USB drive or SD card before the import operation is complete. Otherwise, the USB drive or SD card can become corrupt.

9. Tap OK.

The file is stored on the terminal and captures data in an encrypted format for use by Rockwell Automation technical support.

Export a Troubleshooting Log

To export the troubleshooting log to a USB device or SD card, follow these steps.



1. Press the navigation button on the terminal.
2. Tap Settings, or tab to the menu item and press Enter.



3. Tap Troubleshooting.
4. Insert a USB drive or SD card into the appropriate slot on the terminal.
5. Tap Export.

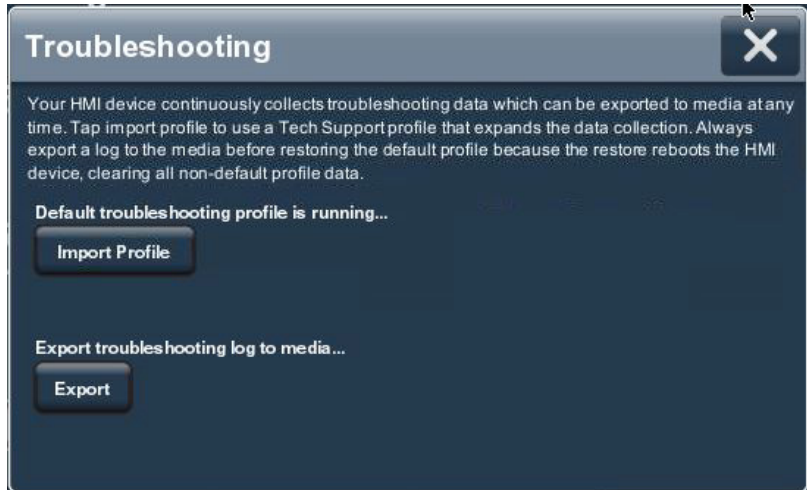

6. Tap Save Troubleshooting Profile.
7. Insert a USB drive or SD card into a slot on the terminal.



8. Tap Export.

The troubleshooting log is exported and the date a time of the last export is displayed next to the Export button.



ATTENTION: Do not remove the USB drive or SD card before the import operation is complete. Otherwise, the USB drive or SD card can become corrupt.

9. To close the window, tap X.

Your technical support contact at Rockwell Automation can provide you with information on where to send the profile.

Terminal Does Not Start Up

If the terminal does not start up normally, check the table for possible causes.

Table 24 - Terminal Does Not Start Up Properly

Check For	What to Do	See
Insufficient power	Make sure that device is receiving adequate power: <ul style="list-style-type: none"> • Check the DC power requirements. • Check AC power requirements. 	page 36 page 37
Improper power wiring	Verify that the power wiring is correct: <ul style="list-style-type: none"> • Check the wiring specifications. • Check the DC power wiring. • Check the AC power wiring. 	page 33 page 36 page 37
Status indicators	Check the status indicators during startup.	page 94
Stalled progress indicator	If a terminal stalls at the progress indicator and does not load an application or configuration screens, restore the factory defaults.	page 103
Stuck keys	Check for stuck keys on terminals with a keypad and function keys. A stuck key can prevent the terminal from starting up properly.	
Does an object touch the display	Verify that nothing is pressing against the display or that you are not touching the display during startup.	

Terminal Restarts Intermittently

If the terminal restarts intermittently, check the table for possible causes.

Table 25 - Terminal Restarts Intermittently

Check For	What to Do	See
Improper power wiring	Verify that the power wiring is correct: <ul style="list-style-type: none"> • Check the wiring specifications. • Check the DC power wiring. • Check the AC power wiring. 	page 33 page 36 page 37
Over-temperature conditions	Make sure that the processor is not exceeding temperatures for normal terminal operations: <ul style="list-style-type: none"> • Check the processor temperature. • Check for adequate clearances around the terminal in the panel. • Check for proper operating temperature. 	page 63 page 24 page 63

Touch Screen Issues

If the touch screen does not operate or respond correctly to touches with a finger or stylus, check the table for possible causes.

Table 26 - Touch Screen Not Responding

Check For	What to Do	See
Improper calibration	Check for activation points offset from touch points. Calibrate the touch screen.	page 59
Non-functional touch screen	Check the touch screen for damage, such as cuts or excessive wear. If there is damage, replace the terminal.	
Multiple input elements touched	Application screens contain graphic input elements that are configured in the View Designer application. When touched, these elements perform operations in a predictable manner. For example, an input element is configured to navigate to a specific screen in the application or start a motor when touched. Multiple operations cannot be conducted simultaneously. Doing so results in an unintended operation. <ul style="list-style-type: none"> • Do not touch multiple input element at one time. • Do not rest a hand or multiple fingers on the display. 	

Display Issues

The display is unreadable or dims unexpectedly.



ATTENTION: If the display darkens, or if the backlight is not functioning properly, the screen can be difficult to read and use of this touch screen could result in a potentially hazardous outcome. **Do not use the touch screen under these circumstances.** The design of the system must take into account the possibility of the touch screen losing functionality and unable to be used to maintain or change control of the system. The touch screen shall not be the single point of control of critical functions and is not intended to replace an E-stop.

Design of the system should follow all applicable code and good engineering practice. Factors to consider include:

- The possibility of an unreadable touch screen
- The possibility of an inoperable touch screen
- Unexpected communication errors or delays
- Operator error in the control of the system
- Proper use of E-stops and other safety practices

The user shall provide means to achieve a safe state during anomalies and make sure the system has adequate redundancy for critical functions.

Failure to follow these instructions can result in death, serious injury, or equipment damage.

Table 27 - Dim Display

Check for	See
Low display brightness setting	Adjust the Brightness of the Display on page 57
Low brightness level of screen saver	Configure the Display Screen Saver on page 58

TIP Extend the life of the backlight by reducing the display brightness, by using the screen saver with reduced brightness, or operating at lower temperatures.

Ethernet Issues

[Table 28](#) provides tips on how to isolate Ethernet anomalies.

Table 28 - Ethernet Connection Issues

Check for	Description
Status of invalid Ethernet connection	<ul style="list-style-type: none"> Green indicator is on when a link is established. Yellow indicator blinks when activity is detected. Verify network connections.
Poor cable connections	Check the Ethernet cabling for the following: <ul style="list-style-type: none"> Make sure that cables are fully connected. Check for cable crimping. Check the Ethernet switch connections. Check the Uplink ports.
Invalid IP address of terminal	If DHCP is enabled, the terminal automatically acquires a valid IP address from the network after startup. The TCP/IP protocol automatically assigns 169.254.xxx.xxx when it fails to acquire an IP address from the network. In general, an IP address that begins with 169 does not support a network connection. See Configure the IP Address of the Terminal on page 52 .
Conflict Between IP addresses	If DHCP is not enabled and a static IP address is specified, make sure that the IP address does not conflict with the address of another device on the network. See Configure the IP Address of the Terminal on page 52 .

Cannot Download Application to Terminal

You are unable to download an application to the terminal.

Table 29 - Unable to Download Project to Terminal

Check for	Description
Application downloads are disabled in Settings screens	Verify that downloads are enabled. See Disable Downloads to the Terminal on page 61 .
Download of project to correct HMI device	Check the following in the View Designer application: <ul style="list-style-type: none"> The project that is downloaded to the correct HMI device IP address of HMI device is correct
Ethernet connection	Make sure that an Ethernet cable is connected between the computer and terminal. Verify that the Ethernet port is configured properly. See Configure the Ethernet Ports on page 55 .

Performance Is Slow

If the response time of the application is slow, for example screen changes or text display changes, check for the following conditions:

- Application screens that contain too many elements
- A controller that is programmed for feedback can cause delays
- Slow network performance or noise can result in retries

Resistance to Chemicals

The outer surfaces of the terminal including the bezel, touch screen overlay, and panel gasket are tested for chemical resistance. Some of the chemicals can cause discoloration, but they do not interfere with the operation of the terminal.

TIP For more information on chemical resistance of the product, go to <http://www.rockwellautomation.com/knowledgebase> and search the Knowledgebase for keywords 'Chemical Resistance PanelView™ Plus'.

IMPORTANT Do not operate the terminal in direct sunlight. Direct exposure to ultraviolet light can discolor the touch screen.

Clean the Display

A protective overlay can help extend the life of the terminal and make it easier to clean the display. [Table 4 on page 17](#) provides catalog numbers for overlays.



ATTENTION: Do not use abrasive cleaners or solvents, they can damage the display. Do not scrub or use brushes.

Do not apply cleaning solution directly on the terminal screen, the solution can drip or seep onto the gasket. Apply cleaning solution to a clean sponge or soft cloth, and gently wipe the screen to remove the dirt and grime.

To clean the display, follow these steps.

1. Disconnect power from the terminal at the power source.



ATTENTION: Do not clean a display while power is applied. If you clean a display while power is applied, you can intendedly activate screen items.

2. To clean the display and prevent scratches, use a clean sponge or soft cloth with mild soap or detergent.
3. Dry the display with a chamois or moist cellulose sponge to avoid water spots.

Remove Paint and Grease

To remove paint or grease from the bezel that is properly mounted in a NEMA, UL Type, or IP rated enclosure, follow these steps.

1. Rub lightly with isopropyl alcohol (70% concentration).
2. To remove residue, use a mild soap or detergent solution.
3. Rinse with clean water.

Equipment Wash Downs



ATTENTION: Do not use a high-pressure washer for cleaning the front bezel of the terminal. A high-pressure washer can damage the terminal.

Do not use a high-pressure washer for cleaning vented enclosures. Water can enter the enclosure and damage the terminal and other equipment.

Ship the Terminal

If you ship the enclosure with the terminal installed, make sure that the terminal is properly secured and protected against damage from impact, sharp objects, or abrasive materials.



ATTENTION: Rockwell Automation is not responsible for damage to a product that is shipped or transported while installed in a panel or enclosure.

Restore Factory Defaults

Restore a terminal to its default settings to refresh the terminal or to recover from an invalid application configuration. The restore process does not affect the firmware revision on the terminal.



ATTENTION: The process that restores factory defaults also removes some data.

- Upload the application with the View Designer application.
- Record the terminal settings so you can update them after the restore.

TIP If a terminal stalls at the progress indicator after a restart and does not load the application or configuration screens, you can restore the factory defaults.

The restore procedure performs the following actions:

- Removes the user application
- Restores the terminal settings to their default state

Table 30 - Factory-default Terminal Settings

Terminal Settings	Factory Default Setting
Backlight intensity: 1...100%	100%
Screen saver <ul style="list-style-type: none"> • Enabled or disabled • Timeout • Dimmer: 1...100% 	<ul style="list-style-type: none"> • Disabled • 10 minutes • 10%
Touch screen calibration	Factory calibrated
Ethernet <ul style="list-style-type: none"> • DHCP-enabled or static IP address • Speed: 10 Mbps, 100 Mbps, Auto sense • Duplex: Half, full, auto sense 	<ul style="list-style-type: none"> • DHCP-enabled • Auto sense link speed • Auto sense duplex mode

To restore the terminal to its default state, follow these steps.

1. Cycle power to the terminal.
The Allen-Bradley logo displays during startup.
2. Wait a few seconds, and then touch the Allen-Bradley logo when the copyright line becomes brighter.

Copyright ©2015 Rockwell Automation

TIP Wait a few seconds before you touch the logo. If you touch the logo too soon during startup, this error text is displayed under the copyright line.

ERROR! FEHLER! ERREUR! ERRORE!

If this error text is displayed, cycle power to the terminal and wait a few seconds longer before you touch the logo.

The normal startup is suspended so the restore procedure can initiate. You are asked if you want to restore the terminal to its defaults.

3. To continue tap Yes, or tap Cancel to resume a normal startup.
You are asked to confirm the removal of all user files such as applications.
4. To continue tap Yes, or tap Cancel to resume a normal startup.
Progress messages appear on the screen during the restore operation. When the restore is complete, the terminal performs a normal startup.
5. From the Settings menu, update the terminal network settings.
6. Download an application to the terminal by using the View Designer application.
7. From the Settings menu, update any remaining terminal settings as appropriate.

Refer to [Disable Downloads to the Terminal on page 61](#) for details on how to modify device configuration settings.

A

- AC power**
 - connection 37
 - functional earth ground 37
 - protective earth 37
- accessories** 17
- ACD file** 15
- alarm**
 - condition 74
 - details 74
 - filter 76
 - function keys 70
 - manager 73
 - summary 72
- application**
 - overview 15
- application download security** 61
- atmospheric gases ignition temperature** 21

B

- back-up power** 82
- battery**
 - back-up power 82
 - lithium 82
 - replace 82
 - state 64
 - warning 82
- branch circuit** 20

C

- cable**
 - capacitance 23
 - inductance 23
 - length between the Ethernet ports 38
- calibration**
 - touch screen 59
- catalog numbers**
 - accessories 17
 - battery replacement 17
 - Ethernet cables 17
 - explanation 16
 - mounting hardware 17
 - PanelView 5500 terminals 16
 - power supplies 17
 - power terminal blocks 17
 - protective overlays 17
 - SD cards 17
- circuit breaker rating** 20
- ControlFLASH software** 87, 88
- cutout dimensions** 24

D

- date and time**
 - setting 66

DC power

- bus 36
- connection 36
- earth ground 37
- device name** 62
- DHCP** 52
- diagnostics**
 - data 63
 - network 56
- dimensions** 25
 - panel cutout 24
 - product 25
- disable downloads to the terminal** 61
- display**
 - brightness 57
 - unreadable or dimming 100
- DNS address**
 - primary 54
 - secondary 54
 - tertiary 54

E

- earth ground**
 - AC 37
 - DC 36, 37
- electrostatic discharge** 79
- environment and enclosure specifications** 20
- equipment wash downs** 102
- ESD**
 - preventing 79
- Ethernet cables** 17
- Ethernet ports** 38
 - duplex mode 55
 - link speed 55
- Ethernet status indicators** 39
- EtherNet/IP network topologies** 38
- explosion hazard** 21, 34, 39, 81, 82

F

- factory defaults** 103
- field wiring compliance** 22
- firmware revision** 63
- firmware update** 87
- firmware upgrade**
 - requirements 88
- function keys** 13
- fuse rating** 20

G

- galvanic isolation** 80

H**hardware specifications**

- audio out 12
- Ethernet ports 12
- mounting slot 12
- SD card slot 12
- status indicators 12
- USB host ports 12

hazardous location 20**HMI keypad 13****I****indicators**

- ERR 94
- error 94
- fault 94
- status 94
- STS 94

installation

- dimensions 25
- environment and enclosure 20
- hazardous location 20
- mounting 26
- panel cutouts 24

IP address

- DHCP 52
- static 53

IP settings

- configuration 53

K**keyboard**

- physical 13
- virtual 47

L**ladder logic 7****log off of the terminal 50****log on to the terminal 49****Logix Designer 14****M****maintain NEMA, UL Type, and IP seals 29****mount the terminal**

- ambient temperature 24
- cutout dimensions 24
- minimum clearances 24
- mounting positions 23
- panel guidelines 24
- preparation 26

mounting levers 26**mouse 13****N****navigation**

- button 13
- keys 13

network diagnostics 56**nonincendive field wiring 23****numeric keypad 13**

- virtual 47

P**panel cutout dimensions 24****perchlorate material 82****power**

- AC
 - connection 37
 - ratings 37
 - terminal block 34
- DC
 - connection 36
 - ratings 36
 - terminal block 34
- PELV 36
- SELV 36
- specifications 12

power supply

- catalog numbers 36

power terminal block

- installing 34
- removing 34
- wiring 34

product compatibility and download center

- 9, 88

protective earth

- AC power 37

protective overlay

- accessories 17
- cleaning 85
- installing 84
- removing 85

publications

- download 9

R**reboot the terminal 65****release notes 9****restore factory defaults 103****ring nodes 39****runtime 15, 46**

S**safety notices**

- electrical arc 39
- electrical shock 37
- explosion hazard 39
- mounting the terminal 30
- nouting positions 23
- unintended operation 13
- water or chemical damage 30

screen saver 58**SD card**

- installing 81
- locked 81
- removing 82
- slot 82
- unlocked 81

startup sequence 42**Studio 5000 Logix Designer** 7

- see also Logix Designer

Studio 5000 View Designer 7

- see also View Designer

supervisor nodes 39**T****tag browser** 15**terminal blocks** 34**time and date**

- setting 66

topology network

- DLR 40
- linear 40
- star 41

touch screen

- calibration 59
- gestures
 - drag 14
 - tap 14

troubleshooting 93

- log, exporting 97
- profile, importing 96

U**USB**

- cables 81
- circuit parameters 22
- device port 80
- host connections 80
- host ports 22
- hubs 80

V**View Designer** 14**virtual**

- keyboard 47
- numeric keypad 47

VPD file 15**W****wash downs** 102**wiring and safety guidelines** 20

Notes:

Rockwell Automation Support

Use these resources to access support information.

Technical Support Center	Find help with how-to videos, FAQs, chat, user forums, and product notification updates.	rok.auto/support
Knowledgebase	Access Knowledgebase articles.	rok.auto/knowledgebase
Local Technical Support Phone Numbers	Locate the telephone number for your country.	rok.auto/phonesupport
Literature Library	Find installation instructions, manuals, brochures, and technical data publications.	rok.auto/literature
Product Compatibility and Download Center (PCDC)	Download firmware, associated files (such as AOP, EDS, and DTM), and access product release notes.	rok.auto/pcdc

Documentation Feedback

Your comments help us serve your documentation needs better. If you have any suggestions on how to improve our content, complete the form at rok.auto/docfeedback.

Waste Electrical and Electronic Equipment (WEEE)



At the end of life, this equipment should be collected separately from any unsorted municipal waste.



Rockwell Automation maintains current product environmental compliance information on its website at rok.auto/pec.

Allen-Bradley, CompactLogix, ControlFLASH, ControlLogix, expanding human possibility, FLEX, Kinetix, PanelView, POINT I/O, RSLinx, Stratix 6000, Studio 5000 Logix Designer, Studio 5000 View Designer, Rockwell Automation, and Rockwell Software are trademarks of Rockwell Automation, Inc.

EtherNet/IP is a trademark of ODVA, Inc.

Trademarks not belonging to Rockwell Automation are property of their respective companies.

Rockwell Otomasyon Ticaret A.Ş. Kar Plaza İş Merkezi E Blok Kat:6 34752, İçerenköy, İstanbul, Tel: +90 (216) 5698400 EEE Yönetmeliğine Uygundur

Connect with us.    

rockwellautomation.com — expanding **human possibility**[®]

AMERICAS: Rockwell Automation, 1201 South Second Street, Milwaukee, WI 53204-2496 USA, Tel: (1) 414.382.2000, Fax: (1) 414.382.4444

EUROPE/MIDDLE EAST/AFRICA: Rockwell Automation NV, Pegasus Park, De Kleetlaan 12a, 1831 Diegem, Belgium, Tel: (32) 2 663 0600, Fax: (32) 2 663 0640

ASIA PACIFIC: Rockwell Automation, Level 14, Core F, Cyberport 3, 100 Cyberport Road, Hong Kong, Tel: (852) 2887 4788, Fax: (852) 2508 1846

Publication 2715-UM001D-EN-P - June 2022

Supersedes Publication 2715-UM001C-EN-P - June 2016

Copyright © 2022 Rockwell Automation, Inc. All rights reserved. Printed in the U.S.A.