



ArmorBlock 5000 16-channel Configurable Digital I/O Module

Catalog Numbers 5032-CFGB16M12DR, 5032-CFGB16M12P5DR,
5032-CFGB16M12M12LDR



Allen-Bradley

by ROCKWELL AUTOMATION

User Manual

Original Instructions

Important User Information

Read this document and the documents listed in the additional resources section about installation, configuration, and operation of this equipment before you install, configure, operate, or maintain this product. Users are required to familiarize themselves with installation and wiring instructions in addition to requirements of all applicable codes, laws, and standards.

Activities including installation, adjustments, putting into service, use, assembly, disassembly, and maintenance are required to be carried out by suitably trained personnel in accordance with applicable code of practice.

If this equipment is used in a manner not specified by the manufacturer, the protection provided by the equipment may be impaired.

In no event will Rockwell Automation, Inc. be responsible or liable for indirect or consequential damages resulting from the use or application of this equipment.

The examples and diagrams in this manual are included solely for illustrative purposes. Because of the many variables and requirements associated with any particular installation, Rockwell Automation, Inc. cannot assume responsibility or liability for actual use based on the examples and diagrams.

No patent liability is assumed by Rockwell Automation, Inc. with respect to use of information, circuits, equipment, or software described in this manual.

Reproduction of the contents of this manual, in whole or in part, without written permission of Rockwell Automation, Inc., is prohibited.

Throughout this manual, when necessary, we use notes to make you aware of safety considerations.



WARNING: Identifies information about practices or circumstances that can cause an explosion in a hazardous environment, which may lead to personal injury or death, property damage, or economic loss.



ATTENTION: Identifies information about practices or circumstances that can lead to personal injury or death, property damage, or economic loss. Attentions help you identify a hazard, avoid a hazard, and recognize the consequence.

IMPORTANT

Identifies information that is critical for successful application and understanding of the product.

These labels may also be on or inside the equipment to provide specific precautions.



SHOCK HAZARD: Labels may be on or inside the equipment, for example, a drive or motor, to alert people that dangerous voltage may be present.



BURN HAZARD: Labels may be on or inside the equipment, for example, a drive or motor, to alert people that surfaces may reach dangerous temperatures.



ARC FLASH HAZARD: Labels may be on or inside the equipment, for example, a motor control center, to alert people to potential Arc Flash. Arc Flash will cause severe injury or death. Wear proper Personal Protective Equipment (PPE). Follow ALL Regulatory requirements for safe work practices and for Personal Protective Equipment (PPE).

The following icon may appear in the text of this document.



Identifies information that is useful and can help to make a process easier to do or easier to understand.

Rockwell Automation recognizes that some of the terms that are currently used in our industry and in this publication are not in alignment with the movement toward inclusive language in technology. We are proactively collaborating with industry peers to find alternatives to such terms and making changes to our products and content. Please excuse the use of such terms in our content while we implement these changes.

	Preface	
	About This Publication	7
	Download Firmware, AOP, EDS, and Other Files	7
	Summary of Changes	7
	Additional Resources	8
	Chapter 1	
Introduction	FAST and Standard I/O Ports	9
	16-point and 8-point Configuration	10
	Controller and Software Compatibility	11
	Module Overview	12
	Secure Access to the System	12
	Ownership	13
	Power the Module	13
	Module Configuration	14
	Module Operation	14
	Requested Packet Interval	14
	Cyclic Mode	14
	Change of State Mode	14
	Secure Web Server	14
	Connections	14
	Protected Operations	15
	Chapter 2	
Module Features	Software Configurable	17
	Configurable Point Modes	17
	Input Output	17
	Input Output, Timestamp	17
	Fault and Status Reporting	17
	Module Inhibiting	18
	Electronic Keying	18
	Update Module Firmware	19
	Input Events	19
	Independent Point Trigger	20
	Pattern Match Trigger	20
	Input Events Latching	20
	Additional Event Considerations	20
	Use CIP Sync Time	21
	Timestamping	21
	Sequence of Events	22
	High-Performance Sequence of Events Applications in the Logix Architecture ..	23
	First Fault Detection	23
	Timestamped I/O	23
	High-Speed Applications	23
	Motion Control	24
	Global Position Registration	24

16-point and 8-point Mode 24

 8-point Mode 25

 16-point Mode 25

Listen Only Mode 26

Protection Mode 26

 Enter and Exit Implicit Protection Mode 26

 Enter and Exit Explicit Protection Mode 26

 Restrictions Imposed By Implicit Protection Mode 27

 Restrictions Imposed By Explicit Protection Mode 27

 Perform Tasks When Restricted 28

Custom IP Address 28

Syslog Event Logging 28

Chapter 3

Input Point Features

Software Configurable Input Filters 29

Chatter Detection 29

Sensor Side Short Circuit Detection 30

 Group Short Circuit 30

Fault and Status Reporting 31

Input Counter 32

Sequence of Events 32

 Operational Modes 32

 Timestamp Latching 32

 Input FIFO 33

 Configure the Module for FIFO Mode 33

 On-board Buffer in FIFO Mode 34

 Manage Data in FIFO Mode 35

 Retrieve Data in FIFO Mode 35

 Standard Retrieval 35

 Retrieval by Point 39

 Input Timestamp 40

 Configure the Module for Per Point Mode 41

 Use Timestamp Latching in Per Point Mode 42

 Use Enable Capture in Per Point Mode 42

 Manage the Data in Per Point Mode 43

 Clear All Data from the Module's Buffers at Once 43

 Pulse Latching 43

Chapter 4

Output Point Features

Time-scheduled Output Control 45

Pulse Width Modulation 46

Configure Point Output State When Module is in Program Mode or Inhibited 47

Configure Point Output State in Communication Fault Mode 47

 Output Behavior Immediately After a Connection Fault 47

 Fault Mode State Duration After Connection Fault 47

 Final Fault Mode State Value 48

Point Output Short Circuit 48

PWM Output Short Circuit 48

Configure the Configurable Digital I/O Module	Chapter 5	
	Configure the Module IP Address	49
	Set the Network Address Switches	49
	Use the BOOTP/DHCP Tool	50
	Add the Module to a Studio 5000 Logix Designer Application Project	50
	Discover Modules	50
	New Module	52
	Edit the Module Properties	53
	Overview View	54
	Connection View	58
	Device Information View	59
	Points View	60
	Input Events View	69
	Internet Protocol View	72
	Port Configuration View	73
	Network View	73
	Time Synchronization View	74
	Servers View	75
	Time-scheduled Output Control	76
	Schedule Outputs Using MAOC	76
	Schedule Outputs Without Using MAOC	77
	Time-scheduled Output Control with PWM (Scheduled PWM)	78
	Reset Module to Factory Default	79
Troubleshoot Your Configurable Digital I/O Module	Appendix A	
	Module Status Indicator	81
	Network Status Indicator	81
	Link Status Indicator	82
	Power Status Indicator	82
	Point Status Indicator	82
	Troubleshoot Wiring Issues	83
	Use the Studio 5000 Logix Designer Application for Troubleshooting	83
	Warning Signal in the I/O Configuration Tree	83
	Status and Fault Information in Module Properties	83
	Diagnostics in Studio 5000 Logix Designer Application	85
	Studio 5000 Logix Designer Application Tag Editor	87
	Module Diagnostic Webpages	88
Configurable Digital I/O Module Device Definitions	Appendix B	
	Tag Name Conventions	89
	Access the Tags	89
	Module Tags	90
	Configuration Tags	90
	Input Tags	92
	Output Tags	95
	Event Input Tags	97
	Event Output Tags	98
	Status Tags	99

Diagnostic Assembly	<p>Appendix C</p> <p>Create User-defined Diagnostic Assembly Types..... 101</p> <p> Diagnostic Assemblies 101</p> <p> Diagnostic Points 104</p> <p>Create Message Type User Tags..... 106</p>
Secure Web Server	<p>Appendix D</p> <p>Browser Requirements..... 109</p> <p>Enable or Disable the Web Server..... 109</p> <p>Access the Web Server Home Page 110</p> <p>Log in to the Web Server 110</p> <p> Mandatory First-time Password Change 111</p> <p> Maximum Limit of Unsuccessful Login Attempts 112</p> <p> Session Timeout - Inactivity Timeout..... 112</p> <p>Web Server Security 113</p> <p> Generate a Self-signed Certificate 114</p> <p>Navigate the Web Server 116</p>
EDS AOP and Assemblies	<p>Appendix E</p> <p>ArmorBlock 5000 Assemblies 117</p> <p> Configuration Assembly 117</p> <p> Input Assembly 118</p> <p> Output Assembly 119</p>
	<p>Index 121</p>

About This Publication

This manual describes how to configure and troubleshoot your ArmorBlock 5000® 16-channel configurable digital module.

Download Firmware, AOP, EDS, and Other Files

Download firmware, associated files (such as AOP, EDS, and DTM), and access product release notes from the Product Compatibility and Download Center at rok.auto/pcdc.

Summary of Changes

This publication contains the following new or updated information. This list includes substantive updates only and is not intended to reflect all changes.

Topic	Page
Updated Connections	14
Updated Configurable Point Modes	17
Removed obsolete publication reference IA-AT003 from topic Use CIP Sync Time	21
Updated Output Features	45
Updated Time-scheduled Output Control	45
Added Pulse Width Modulation	46
Updated Configure Point Output State When Module is in Program Mode or Inhibited	47
Added PWM Output Short Circuit	48
Updated table Configurable Digital I/O Device Definition Parameters	55
Updated table Connection Types for Configurable Digital I/O Module	55
Updated table Configurable Digital I/O Device Definition Point Assignments Parameters	57
Updated the following sections:	
• Ptxx Views	60
• Ptxx - Counter	61
• Ptxx - Input	61
• Ptxx - Input, Timestamp	62
• Ptxx - Input, FIFO	63
• Ptxx - Output	64
• Ptxx - Output, Scheduled	64
• Ptxx - Output, PWM	65
• Ptxx - Output, Scheduled, PWM	66
• Ptxx - Input Output	66
• Ptxx - Input Output - Input	67
• Ptxx - Input Output - Output	67
• Ptxx - Input Output, Timestamp	68
• Ptxx - Input Output, Timestamp - Input	68
• Ptxx - Input Output, Timestamp - Output	69
Updated section Servers View	75
Updated Time-scheduled Output Control	76
Added section Schedule Outputs Without Using MAOC	77
Added Time-scheduled Output Control with PWM (Scheduled PWM)	78
Updated the following tables:	
• Configurable Digital I/O Module Configuration Tags	92
• Configurable Digital I/O Module Input Tags	93, 95
• Configurable Digital I/O Module Output Tags	96, 97
Updated Access the Web Server Home Page	110
Added Important information in Log in to the Web Server	111
Added appendix EDS AOP and Assemblies	117

Additional Resources

These documents contain additional information concerning related products from Rockwell Automation. You can view or download publications at rok.auto/literature.

Additional Resources

Resource	Description
ArmorBlock 5000 I/O Modules Technical Data, publication 5032-TD001	Provides specifications for ArmorBlock 5000 I/O modules and accessories.
ArmorBlock 5000 16-channel Configurable Digital I/O Module Installation Instructions, publication 5032-IN002	Describes how to install and wire the ArmorBlock 5000 16-channel configurable digital I/O modules.
EtherNet/IP Network Devices User Manual, publication ENET-UM006	Describes how to configure and use EtherNet/IP™ devices to communicate on the EtherNet/IP network.
Ethernet Reference Manual, publication ENET-RM002	Describes basic Ethernet concepts, infrastructure components, and infrastructure features.
System Security Design Guidelines Reference Manual, publication SECURE-RM001	Provides guidance on how to conduct security assessments, implement Rockwell Automation products in a secure system, harden the control system, manage user access, and dispose of equipment.
UL Standards Listing for Industrial Control Products Specifications, publication CMPNTS-SR002	Assists original equipment manufacturers (OEMs) with construction of panels, to help achieve that they conform to the requirements of Underwriters Laboratories.
Safety Guidelines for the Application, Installation, and Maintenance of Solid-state Control, publication SGI-1.1	Designed to harmonize with NEMA Standards Publication No. ICS 1.1-1987 and provides general guidelines for the application, installation, and maintenance of solid-state control in the form of individual devices or packaged assemblies incorporating solid-state components.
Industrial Automation Wiring and Grounding Guidelines, publication 1770-4.1	Provides general guidelines for installing a Rockwell Automation industrial system.
Product Selection and Configuration website, rok.auto/systemtools	Helps configure complete, valid catalog numbers, and build complete quotes that are based on detailed product information.
Product Certifications website, rok.auto/certifications	Provides declarations of conformity, certificates, and other certification details.

Introduction

The ArmorBlock 5000 16-channel configurable digital I/O module provides 16 points that can be configured individually as an input or output. Each configurable module has fast and high current points.

The fast and high current points support input timestamping, counter, and Sequence of Event functionality when configured as inputs as well as the ability to use Scheduled Output when configured as outputs.

Fast I/O ports (P0...P3) are powered by MSA (Module/Sensor/Actuator) and standard I/O ports (P4...P7) are powered by LA (Local Actuator).

- Supports fast configurable I/O up to 25 kHz depending on point mode configuration^(a)
- Standard configurable I/O able to drive current up to 2 A
- Supports input timestamp, Sequence of Events, and Schedule Output

FAST and Standard I/O Ports

The ArmorBlock 5000 configurable digital I/O module supports fast and standard I/O ports.

- Ports P0...P3 support fast I/O.
Fast I/O ports support up to 33 kHz in counter mode.
- Ports P4...P7 support standard I/O.
Standard I/O ports support up to 2.5 kHz.

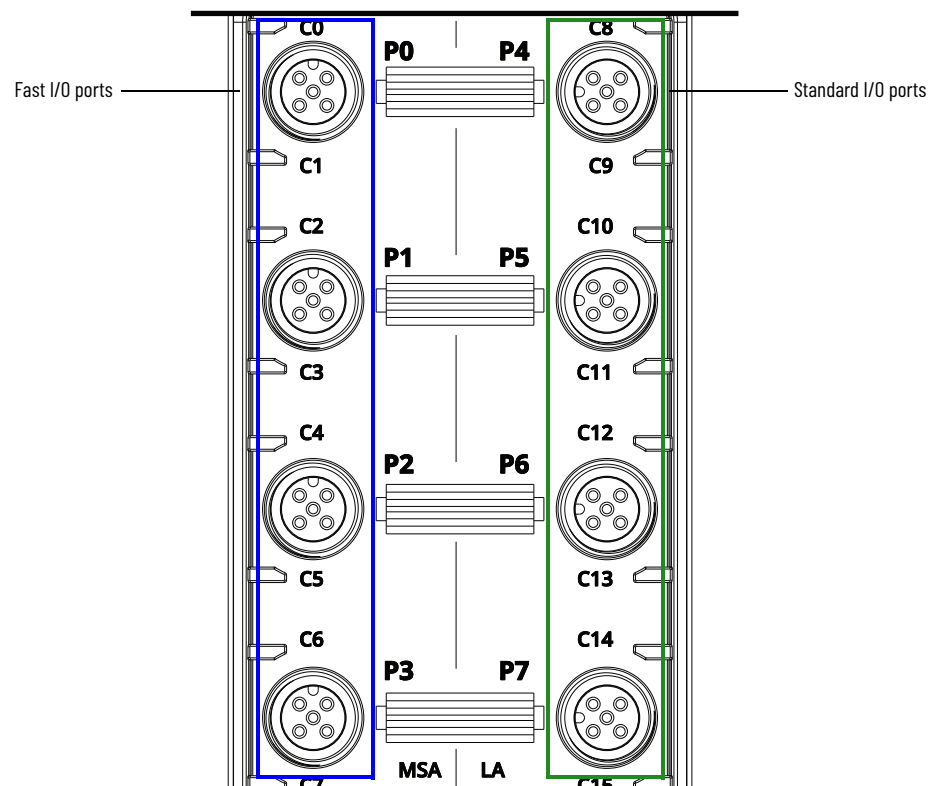

(a) For more information on fast configurable I/O port specifications, see [Input Point Features on page 29](#).

16-point and 8-point Configuration

The ArmorBlock 5000 configurable digital I/O module supports 16-point and 8-point mode. In 16-point mode, you can configure all 16 points. In 8-point mode, you can configure one point per port.

5032-CFGB16M12DR in 16-point Mode

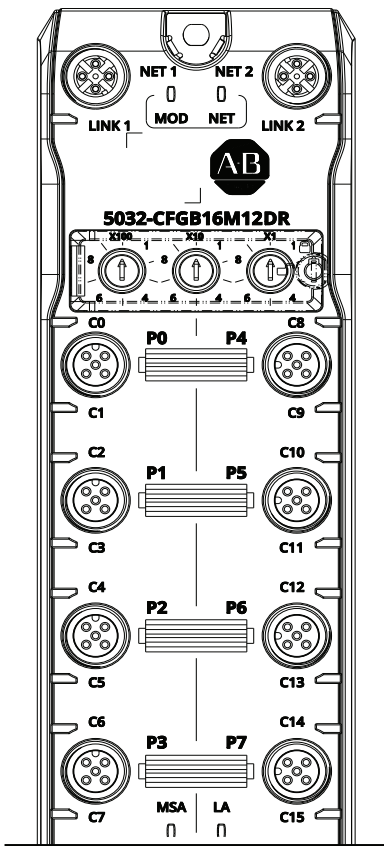

5032-CFGB16M12P5DR in 8-point Mode^(a)
(with Module Overlay)

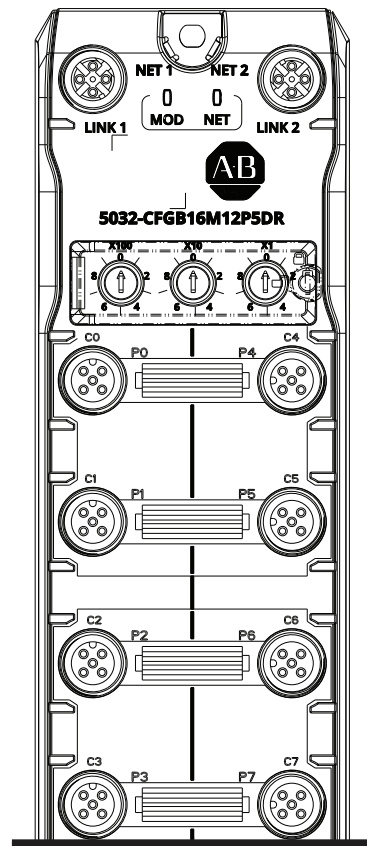

(a) In 8-point mode, pin 2 of each port is disabled.

Controller and Software Compatibility

Controller and programming software compatibility requirements apply when you use the ArmorBlock 5000 16-channel configurable digital I/O module, as described in [Table 1](#).

Table 1 - Module Compatibility

Module	Controllers		Studio 5000 Logix Designer® Application Version	FactoryTalk® Linx Software Version
	System	Catalog Numbers		
5032-CFGB16M12DR 5032-CFGB16M12P5DR 5032-CFGB16M12M12LDR	CompactLogix 5380 Standard and Process controllers	5069-L306ER, 5069-L306ERM, 5069-L310ER, 5069-L310ERM, 5069-L310ERMK, 5069-L310ER-NSE, 5069-L320ER, 5069-L320ERM, 5069-L320ERMK, 5069-L320ERP, 5069-L330ER, 5069-L330ERM, 5069-L330ERMK, 5069-L340ER, 5069-L340ERM, 5069-L340ERP, 5069-L350ERM, 5069-L350ERMK, 5069-L380ERM, 5069-L3100ERM	35.00.00 or later	6.31.00 or later
	Compact GuardLogix 5380 SIL 2 controllers	5069-L306ERS2, 5069-L306ERMS2, 5069-L310ERS2, 5069-L310ERS2K, 5069-L310ERMS2, 5069-L310ERMS2K, 5069-L320ERS2, 5069-L320ERS2K, 5069-L320ERMS2, 5069-L320ERMS2K, 5069-L330ERS2, 5069-L330ERS2K, 5069-L330ERMS2, 5069-L330ERMS2K, 5069-L340ERS2, 5069-L340ERMS2, 5069-L350ERS2, 5069-L350ERS2K, 5069-L350ERMS2, 5069-L350ERMS2K, 5069-L380ERS2, 5069-L380ERMS2, 5069-L3100ERS2, 5069-L3100ERMS2		
	Compact GuardLogix 5380 SIL 3 controllers	5069-L306ERMS3, 5069-L310ERMS3, 5069-L310ERMS3K, 5069-L320ERMS3, 5069-L320ERMS3K, 5069-L330ERMS3, 5069-L330ERMS3K, 5069-L340ERMS3, 5069-L350ERMS3, 5069-L350ERMS3K, 5069-L380ERMS3, 5069-L3100ERMS3		
	CompactLogix 5480 controllers	5069-L430ERMW, 5069-L450ERMW, 5069-4100ERMW, 5069-L4200ERMW, 5069-L46ERMW		
	ControlLogix 5580 Standard and Process controllers	1756-L81E, 1756-L81EK, 1756-L81E-NSE, 1756-L81EXT, 1756-L81EP, 1756-L82E, 1756-L82EK, 1756-L82E-NSE, 1756-L82EXT, 1756-L83E, 1756-L83EK, 1756-L83E-NSE, 1756-L83EXT, 1756-L83EP, 1756-L84E, 1756-L84EK, 1756-L84E-NSE, 1756-L84EXT, 1756-L85E, 1756-L85EK, 1756-L85E-NSE, 1756-L85EXT, 1756-L85EP		
	GuardLogix 5580 controllers	1756-L81ES, 1756-L81ESK, 1756-L82ES, 1756-L82ESK, 1756-L83ES, 1756-L83ESK, 1756-L84ES, 1756-L84ESK, 1756-L8SP, 1756-L8SPK, 1756-L81EXTS, 1756-L82EXTS, 1756-L83EXTS, 1756-L84EXTS, 1756-L8XTSP		

For more information on the controllers, see the following publications:

- CompactLogix® 5380 and Compact GuardLogix® 5380 Controllers User Manual, publication [5069-UM001](#)
- CompactLogix 5480 Controllers User Manual, publication [5069-UM002](#)
- ControlLogix® 5580 and GuardLogix 5580 Controllers User Manual, publication [1756-UM543](#)

Module Overview

Figure 1 shows the parts of an ArmorBlock 5000 16-channel configurable digital I/O module.

Figure 1 - ArmorBlock 5000 16-channel Configurable Digital I/O Module Overview

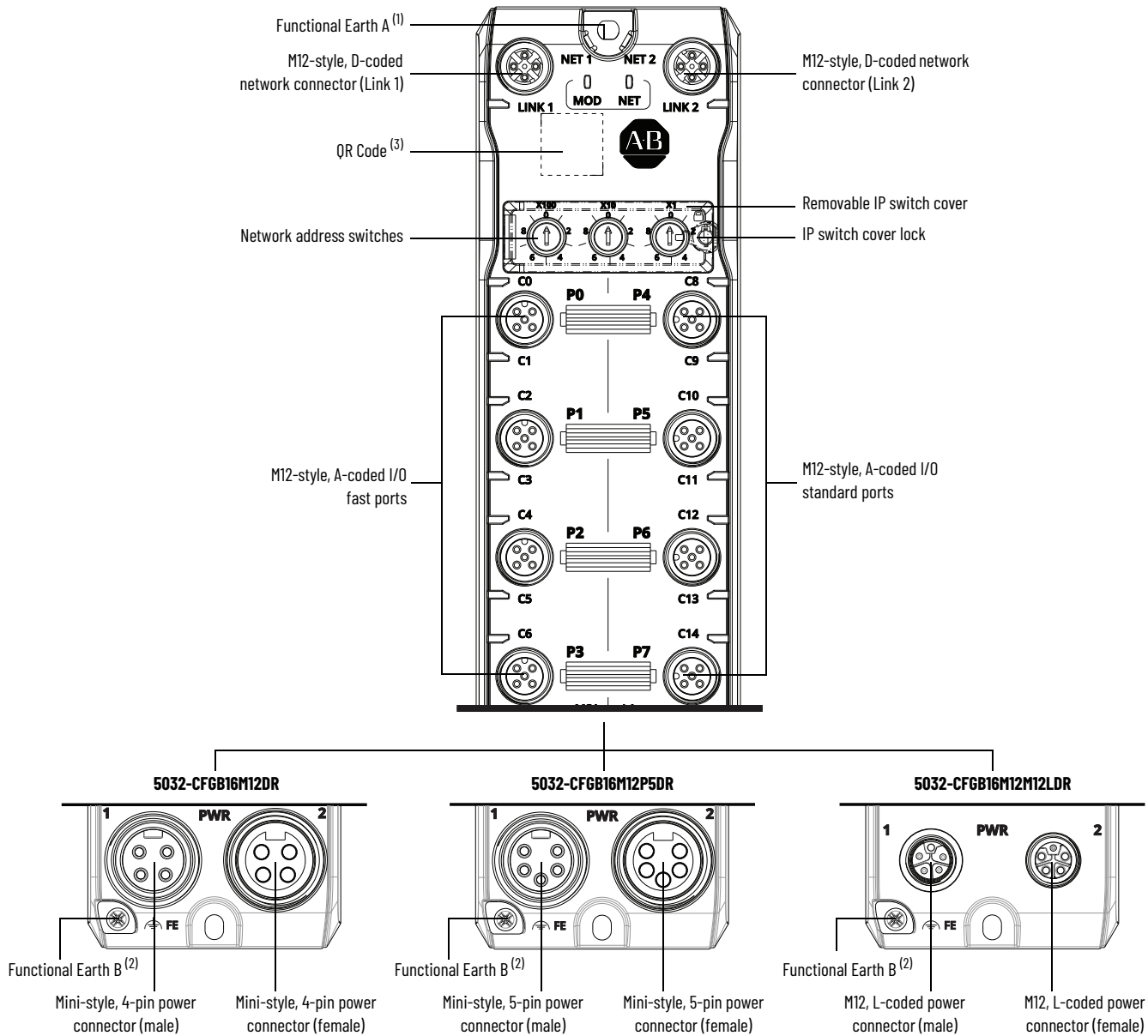

- (1) Functional Earth A grounds the module EtherNet/IP communication circuitry, which is designed to mitigate the effect of noise on the network. The module requires a solid earth ground connection, either through a metal screw to a grounded metal panel or through a wire.
- (2) Functional Earth B grounds the module I/O and power circuitries to mitigate the effect of noise on the network. Functional Earth B is internally connected to pin 5 of power connectors in 5032-CFGB16M12P5DR and 5032-CFGB16M12M12LDR. The module requires a solid earth ground connection, either through the mini-style 5-pin or M12 L-coded power patchcord, or through a wire to the screw point.
- (3) The QR Code contains a link to the product webpage that provides details on the product such as lifecycle status and documentation.

Secure Access to the System

To secure access to a Logix 5000® controller and ArmorBlock 5000 16-channel configurable digital I/O module by authorized users only, consider the following options:

- Follow the guidelines provided in the System Security Design Guidelines Reference Manual, publication [SECURE-RM001](#).
- Password protect the source and execution of the control program.
- Deploy EtherNet/IP devices in accordance with recommended architectures and concepts. See the Converged Plantwide Ethernet (CPwE) Design and Implementation Guide, publication [ENET-TD001](#).
- Implement physical barriers, such as locked cabinets.

To secure access to the system, consider the following options:

- Follow industry best practices to harden your PCs and servers, including anti-virus/anti-malware and application allow list solutions.
The recommendations are published at the Rockwell Automation technical support center in Knowledgebase article *Rockwell Automation Customer Hardening Guidelines*, [#546987](#). The technical support center is available at: rok.auto/knowledgebase.
- Develop and deploy backup and disaster recovery policies and procedures. Test backups on a regular schedule.
- Minimize network exposure for all control system devices and systems, and make sure that they are not accessible from the Internet.
- Locate control system networks and devices behind firewalls and isolate them from the business network.
- Subscribe to Knowledgebase article *Industrial Security Advisory Index*, [#54102](#) at the Rockwell Automation technical support center so you have access to information about security matters that affect Rockwell Automation products. The technical support center is available at: rok.auto/knowledgebase.

Ownership

A controller must own every configurable digital I/O module in a Logix 5000 control system. In a Logix 5000 control system, the controller establishes the connection to the module to begin operation in the control system.

Each configurable digital I/O module must continuously maintain communication with its controller during normal operation.

Power the Module

The ArmorBlock 5000 16-channel configurable digital I/O module uses two 24V DC (nominal) power supplies. These supplies are called the MSA power and LA power. Internally, the MSA power and LA power are isolated from each other.

- MSA power provides power to the module and all eight fast I/O (P0...P3) points of the module.
- LA power provides power to all eight standard I/O (P4...P7) points of the module.

Power can be daisy chained from one module to the next. You can also install a separate power supply to each module.

Take note of the following when you supply power to your system:

- The voltage range for MSA power is 18...30V DC for digital I/O mode.
- The maximum current that any module can carry is 10 A.
- The maximum current that any pin on the 4-pin or 5-pin mini power connectors can carry is 10 A.
- The maximum current that any pin on the M12 L-coded power connectors can carry is 16 A.
- Confirm that the external module power supply is adequately sized for the total current draw of the module power bus in the system.
- Not all power supplies are certified for use in all applications, for example, nonhazardous and hazardous environments.



ATTENTION: Power to this equipment and all connected I/O must be supplied from a source compliant with the following:

- The ArmorBlock 5000 16-channel configurable digital I/O modules connect to an external power supply and offer a capability of up to 10 A @24V DC, which is >100VA. If any I/O devices connected to this equipment requires <100VA (Class 2) power to operate, the ArmorBlock 5000 I/O module must be powered by UL certified Class 2 sources (one for MSA and one for LA).
- You must use two separate Safety Extra Low Voltage (SELV) listed or Protected Extra Low Voltage (PELV) listed power supplies, or one SELV-listed or PELV-listed power supply with two pairs of separately isolated terminals for module power.

Module Configuration

You must create a Studio 5000 Logix Designer application project for the controller that owns the ArmorBlock 5000 16-channel configurable digital I/O module. You can configure the module in the project.

The Studio 5000 Logix Designer application transfers the project to the controller during the program download.

For more information on how to configure a configurable digital I/O module, see [Configure the Configurable Digital I/O Module on page 49](#).

Module Operation

The configurable digital I/O module operates through connections. Connections work in either cyclic mode or Change of State (COS) mode.

Requested Packet Interval

The Requested Packet Interval (RPI) is a configurable parameter that defines a specific rate at which the controller exchanges data with the configurable digital I/O module.

You set the RPI value during initial module or device configuration and can adjust it as necessary after operation has begun.

IMPORTANT

You can change the RPI while the project is online. If you change the RPI while the project is online, the connection to the configurable digital I/O module is closed and reopened in one of the following ways:

- You inhibit the connection to the module, change the RPI value, and uninhibit the connection.
 - You change the RPI value. In this case, the connection is closed and reopened immediately after you apply the change to the module configuration.
-

For more information on guidelines for specifying RPI rates, see the Logix 5000 Controllers Design Considerations Reference Manual, publication [1756-RM094](#).

Cyclic Mode

All connections work in cyclic mode, except for input event connections. In cyclic mode, the configurable digital I/O module sends input data at the time that is defined in the RPI. Similarly, the controller sends output data at the time that is defined in the RPI.

Change of State Mode

For input event connections, the configurable digital I/O module uses Change of COS mode to update the input data. New data is sent to the controller immediately when a transition occurs. When there is no change of state, the data is sent at the time that is defined in the RPI.

Secure Web Server

The ArmorBlock 5000 16-channel configurable digital I/O module is equipped with a secure web server to provide increased security while allowing you to configure settings and monitor diagnostic data.

Connections

The ArmorBlock 5000 16-channel configurable digital I/O module supports up to 16 cache connections.

You can define connections for the configurable digital I/O module by choosing a connection type. A connection is a real-time data transfer link between the controller and the module that the project references.

During configurable digital I/O module configuration, the connection type determines what data is exchanged between the controller and the module. When you uninhibit a module in online mode, or download the project with modules that are uninhibited to the controller, the controller attempts to establish a connection to each module.

One of the following occurs:

- If the configuration is appropriate to the module that is detected, a connection is made and operation begins.
- If the configuration is not appropriate to the module that is detected, the data is rejected and the Studio 5000 Logix Designer application indicates that an error occurred.

The configuration can be inappropriate for many reasons. For example, a mismatch in Electronic Keying that helps prevent normal operation.

For more information on how to troubleshoot issues, see [Troubleshoot Your Configurable Digital I/O Module on page 81](#).

The controller monitors its connection with a configurable digital I/O module. Any break in the connection, for example, the loss of power to the system, causes a fault. The Studio 5000 Logix Designer application monitors the fault status tags to indicate when a fault occurs on a configurable digital I/O module.

To see where to change the connection type see [Connection View on page 58](#).

Protected Operations

To maintain the secure operation of your configurable digital I/O module, operations that can disrupt the module and device operations are restricted based on the operating mode.

[Table 2](#) describes the restrictions.

Table 2 - Protected Operations on ArmorBlock 5000 16-channel Configurable Digital I/O Modules

Current Operation	Activity						
	Firmware Update Request	Reset Request	Connection Request	Configuration Change	Connection or Data Format Change	Electronic Keying Change	RPI Change
Connection not running	Accepted						
Connection running	Rejected		Rejected	Accepted ⁽¹⁾	Not allowed ⁽²⁾		Accepted ⁽³⁾
Firmware update in process	Rejected						

(1) Configuration change is accepted in the following scenarios:

- Changes are made in the Module Properties window and you select Apply.
- Changes are made in the Configuration tags and you send a Reconfigure Module MSG instruction to the device.

(2) The difference between Rejected and Not allowed is that rejected activities can be attempted in the Studio 5000 Logix Designer application but do not take effect. The activities that are not allowed, that is, attempts to change the Connection or Data Format used, do not occur in the Studio 5000 Logix Designer application. For example, if you attempt to reset a module that is connected to the controller, the Studio 5000 Logix Designer application executes the request and alerts you that it was rejected. If you attempt to change the data format on a module that is connected to a controller, the Studio 5000 Logix Designer application does not execute the attempted change. The application only alerts you that the change is not allowed. In this case, if the change is attempted online, the Device Definition dialog field that changes the data format is disabled.

(3) The change occurs after the connection is closed and reopened. You can close and reopen the connection in the following ways:

- Change the project while it is online and select Apply or OK in the Module Properties window. In this case, before the change is made, a dialog box alerts you of the ramifications before the change is made.
- Change the project while it is offline and download the updated project before going online again.

For more information on the protected operating modes, see [Protection Mode on page 26](#).

Notes:

Module Features

This chapter describes the general features of the ArmorBlock 5000 16-channel configurable digital I/O modules.

To learn more about the other features of the configurable digital I/O module, see the following:

- [Input Point Features](#)
- [Output Point Features](#)

Software Configurable

You use the Studio 5000 Logix Designer application to configure the module, monitor system operation, and troubleshoot issues.

The software simplifies module configuration and minimizes the need for tasks such as setting hardware switches and jumpers.

Configurable Point Modes

You can configure each point of the ArmorBlock 5000 16-channel configurable digital I/O module as a digital input (such as, "Input" or "Input, Timestamp") or as a digital output (such as, "Output").

To configure the point mode, see [Overview View on page 54](#).

Input Output

You can switch a point between digital input and digital output modes, without changing configuration tags, by using the *O.Ptxx.OutputEn* output tag.

The module does not need to be offline to change the active point mode.

You can configure a point as "Input Output" only if the Device Definition parameters MAOC Compatible Data is set to No and Timestamp is set to FIFO.

For more information on input and output features, see [Input Point Features on page 29](#) and [Output Point Features on page 45](#).

Input Output, Timestamp

You can switch a point between digital input, timestamp and digital output, timestamp modes, without changing configuration tags, by using the *O.Ptxx.OutputEn* output tag.

The module does not need to be offline to change the active point mode.

You can configure a point as "Input Output, Timestamp", only if the Device Definition parameters MAOC Compatible Data is set to No and Timestamp is set to Per Point.

For more information on input and output features, see [Input Point Features on page 29](#), [Input Timestamp on page 40](#), and [Output Point Features on page 45](#).

Fault and Status Reporting

The ArmorBlock 5000 16-channel configurable digital I/O module reports fault and status data along with point data. Fault and status data is reported in the following ways:

- Fault and status bits in the input data tags
- Studio 5000 Logix Designer application
- Module status indicators

[Table 3](#) lists the fault and status tags that are available for the configurable digital I/O module in the Studio 5000 Logix Designer application.

Table 3 - Fault and Status Tags for ArmorBlock 5000 16-channel Configurable Digital I/O Module

Data Type	Tag Name	Triggering Event That Sets the Tag
Fault	ConnectionFaulted ⁽¹⁾	The controller loses its connection to the module.
	RunMode	The module is in Run Mode.
Status	DiagnosticActive	Indicates if any diagnostics are active or if the prognostics threshold is reached
	DiagnosticSequenceCount	The count increments each time that a diagnostic condition is detected or removed. You can monitor this count during the module operation and check the point diagnostics when the count value changes.

(1) This tag provides module-wide data and affects all points simultaneously.

For more information on fault reporting in the Studio 5000 Logix Designer application and module status indicators, see [Troubleshoot Your Configurable Digital I/O Module on page 81](#).

Module Inhibiting

Module inhibiting lets you indefinitely suspend a connection between a controller and a module without removing the module from the configuration. This process temporarily stops the connection between the controller and the module.

IMPORTANT Whenever you inhibit a module with outputs, all outputs change to the state that is configured for Program mode.
For more information, see [Configure Point Output State in Communication Fault Mode on page 47](#).

You can use module inhibiting in the following scenarios.

- You want to perform maintenance on the module.
- You want to update a module, for example, update the module firmware revision.
- You use a program that includes a module that you do not physically possess yet. You do not want the controller to look for a module that does not yet exist. In this case, you can inhibit the module in your program until it physically resides in the system.

Use the following procedure.

1. Inhibit the module.
2. Perform the action on the module.
3. Uninhibit the module.

To inhibit a module, see [Connection View on page 58](#).

Electronic Keying

Electronic Keying reduces the possibility that you use the wrong module in a control system. It compares the device that is defined in your project to the installed module. If keying fails, a fault occurs. These attributes are compared.

Attribute	Description
Vendor	The module manufacturer
Device Type	The general type of the device, for example, digital I/O module.
Product Code	The specific type of the product. The Product Code maps to a catalog number.
Major Revision	A number that represents the functional capabilities of a module.
Minor Revision	A number that represents behavior changes in the module.

[Table 4](#) lists the available Electronic Keying options.

Table 4 - Electronic Keying Options

Keying Option	Description
Compatible Module	Lets the installed module accept the key of the module that is defined in the project when the installed module can emulate the defined module. With Compatible Module, you can typically replace a module with another module that has the following characteristics: <ul style="list-style-type: none"> • Same catalog number • Same or higher Major Revision • Minor Revision as follows: <ul style="list-style-type: none"> - If the Major Revision is the same, the Minor Revision must be the same or higher. - If the Major Revision is higher, the Minor Revision can be any number.
Disable Keying	Indicates that the keying attributes are not considered when attempting to communicate with a module. With Disable Keying, communication can occur with a module other than the type specified in the project. WARNING: Be extremely cautious when using Disable Keying; if used incorrectly, this option can lead to personal injury or death, property damage, or economic loss. We strongly recommend that you do not use Disable Keying. If you use Disable Keying, you must take full responsibility for understanding whether the module being used can fulfill the functional requirements of the application.
Exact Match	Indicates that all keying attributes must match to establish communication. If any attribute does not match precisely, communication with the module does not occur.

Carefully consider the implications of each keying option when selecting one.

IMPORTANT	Changes to Electronic Keying parameters while the project is online interrupts connections to the module. Connections from other controllers can also be broken. If an I/O connection to a module is interrupted, the result can be a loss of data.
------------------	--

For more detailed information on Electronic Keying, see Electronic Keying in Logix 5000 Control Systems Application Technique, publication [LOGIX-AT001](#).

Update Module Firmware

The ArmorBlock 5000 16-channel configurable digital I/O module is manufactured with module firmware installed. If updated module firmware revisions are available in the future, you can update the firmware.

Updated firmware revisions are available for various reasons, for example, to correct an anomaly that existed in previous module firmware revisions.

IMPORTANT	Verify that you are using the correct firmware revisions for your modules before commissioning your system.
------------------	---

You can access the updated firmware files at the Rockwell Automation Product Compatibility and Download Center (PCDC) website, rok.auto/pcdc.

At the PCDC website, you can use the module catalog number to check for firmware updates. If the catalog number is not available, no updates exist then.

Input Events

The ArmorBlock 5000 16-channel configurable digital I/O module can be configured with four input event definitions.

To use Input Events, select the "Data with Events" or "Data with Events and Ethernet Status" connection type in the configurable I/O Device Definition dialog.

To change the connection type, see [Overview View on page 54](#).

The following conditions can trigger events:

- An input state change
- A counting input done bit change
- A pattern of input state changes on multiple module inputs

When the module reports an input event to the controller, the module can trigger an event task to execute in the controller. The event task lets you execute a section of logic immediately when an event, or receipt of new data, occurs.

For more information on event tasks, see the Logix 5000 Controllers Tasks, Programs, and Routines Programming Manual, publication [1756-PM005](#).

Independent Point Trigger

An input state change or a counting input bit done change that triggers an event is known as an independent point trigger.

To use this type of trigger, you must enable the Independent Point Trigger option in the event definition. Set the *EO.Eventxx.IndependentConditionTriggerEn* tag to 1.

Pattern Match Trigger

When a pattern of input state change triggers an event, multiple points participate in the event trigger. To use this type of trigger, you must disable the Independent Point Trigger option in the event definition. Set the *EO.Eventxx.IndependentConditionTriggerEn* tag to 0.

Every point that participates in an event trigger is configured separately. Depending on the event definition, the collective status of all points that matches the pattern triggers the event.

Input Events Latching

To use input event latching, you must select the Latch Event checkbox for that input event. Set the *EO.Eventxx.LatchEn* tag to 1.

When input event latching is used, the event in the input data must be acknowledged before a new event is sent out.

To acknowledge the current event in the input data, set the *EO.Eventxx.EventNumberAck* tag to the event number (*EI.Eventxx.EventNumber* tag) in the input data.

If the current event is not acknowledged, subsequent events are stored in a queue. The queue can store up to four events. If the queue is full, excess events are dropped.

Additional Event Considerations

When you use the Input Events feature, also consider the following:

- An Event task only actuates if an event occurs.

IMPORTANT	Make sure that you link the Event task to the Event Input tag, not the Input tag. Keep in mind that when the Event task executes, the input tag data can have the same data that was sent at the last RPI.
------------------	---

- An event is recognized only when it maintains the same state for the minimum duration that is determined by the input filter time specified.
For example, if the input filter time is set at 2 ms, and the input filter time accuracy is -50...+400 μ s (except for 0 μ s filter time setting):
 - A pulse width that is shorter than 1.95 ms is not detected.
 - A pulse width that is longer than 2.4 ms is detected.
 - A pulse width that is between 1.95...2.4 ms may or may not be detected.
- When you configure the RPI of the input event connection, consider that the minimum interval between two input data packets of event connection is one quarter of the RPI connection.
- After the event task executes, it does not execute again until the event occurs again.

- When the input event connection is reopened, the *El.Eventxx.PtxxData* tag is reset to 0.

Use CIP Sync Time

CIP Sync™ is a CIP implementation of the IEEE 1588 PTP (Precision Time Protocol). CIP Sync provides accurate real-time (Real-World Time) or Universal Coordinated Time (UTC) synchronization of controllers and devices that are connected over CIP networks. This technology supports highly distributed applications that require timestamping, sequence of events recording, distributed motion control, and increased control coordination.

The ArmorBlock 5000 16-channel configurable digital I/O module is a CIP Sync slave-only device. There must be another module on the network that functions as a master clock.

You can use the configurable digital I/O module fast I/O ports to capture timestamps and schedule outputs while providing the following advances:

- Fast I/O ports have much higher precision than standard I/O ports.
- Enable or disable Timestamp Latching for rising or falling edge on point modes
- CIP Sync is system-wide, so timestamp and schedule values are consistent across all modules in the system.
- Modules that are configured for Scheduled Output use all 64 bits of the timestamp to schedule, so there are no limits on schedule ranges.

Timestamping

The control system uses a 64-bit system clock. The modules support CIP Sync timestamping by using the 1588 protocol that is passed throughout the system.

The 1588 protocol is defined in the IEEE 1588-2002 standard, publication Standard for a Precision Clock Synchronization Protocol for Networked Measurement and Control Systems.

Each input point scan or new output application is stamped with a CIP Sync timestamp. One timestamp is returned to the controller for the module with the input data transfer.

You can use this feature for the following:



- To identify the sequence of events in fault conditions or during normal operation
You can use the system clock between multiple modules in the same chassis or throughout a system in which a common Time Master is used.
- To measure the change between samples and detect when a new sample is available for processing via the logic. The change between sample likely correlates closely with the RPI if no samples are missed in the logic.

You can also use the 1588 Protocol to synchronize sampling for modules across the entire system. By using the Synchronized Sampling feature, you can configure multiple modules to coordinate their input samples precisely with each other by using the same RPI.

Synchronized Sampling lets you configure a test stand, for example, and take many measurements simultaneously across many modules, if needed, while still precisely coordinating the sampling. With these modules, the synchronized sampling coordinates within approximately $\pm 20 \mu\text{s}$.

[Table 5](#) lists the available timestamp options.

Table 5 - Timestamp Options

Topic	Description
Timestamping for a sequence of events	<p>You can use CIP Sync to establish a sequence of events occurring at a particular input module point by timestamping the input data. To determine a sequence of events, you must complete the following:</p> <ul style="list-style-type: none"> • Set the format of the input module to Timestamped Input Data. • Enable Timestamp Latching for the input where a sequence occurs, and disable Timestamp Latching for all other points on the module. <p> If you configure multiple inputs for timestamping, your module generates a unique timestamp each time any of those inputs change state if the changes do not occur within 500 μs of each other. If multiple inputs that are configured for timestamping change state within 500 μs of each other, one timestamp is generated for all state changes. As a result, it appears as if they changed simultaneously.</p>
Timestamping with scheduled outputs	<p>You can use timestamping with the scheduled outputs feature, so that once input data changes state and a timestamp occurs, an output point actuates at a specific time. You can schedule outputs into the future. Outputs that are sent in one packet can differ by approximately 2 s. Sending in multiple messages allows greater spacing between schedules. When you use timestamping of inputs and scheduled outputs, you must complete the following:</p> <ul style="list-style-type: none"> • Choose a connection format for each input and output module that enables timestamping. • Disable Timestamp Latching for all input points on the input module except the point being timestamped. <p> For scheduled outputs to work most effectively, remember the following:</p> <ul style="list-style-type: none"> • The schedule triggers when it is configured to. You must make sure that there is enough time for the schedule to plan ahead. If you are using an MAOC instruction, you cannot control the schedule. • A system-level Grandmaster clock synchronizes the times of the I/O modules.

For more information on the Input Timestamping feature, see [Input Timestamp on page 40](#).

For more information on the Scheduled Outputs features, see [Time-scheduled Output Control on page 45](#).

Sequence of Events

The ArmorBlock 5000 16-channel configurable digital I/O module can be configured as an input module that offers submillisecond timestamping on a per point basis and providing the basic On/Off detection. It supports two modes of operation: Per Point mode and FIFO (First In First Out) mode. To learn more about how to use the modules in these modes of operation, see [Ptxx Views on page 60](#).

All input point event times are recorded and returned in a single buffer. The module returns two 64-bit timestamps for each input that allows:

- On and Off events for each point to display simultaneously in the input data
- Ladder logic to not be explicitly required to see events, although needed to archive events
- Events to be kept in the controller memory during remote power loss to eliminate data loss

You can filter all inputs on the module for both On-to-Off and Off-to-On transitions. The timestamp for a filtered input is the time of the initial transition to the new state and not the time that the filter validates the event as real.

Selective Event Capturing allows you to disable particular events per input and per transition, On-to-Off or Off-to-On.

Event latching ensures that events are not overwritten. A single transition in each direction is recorded per point. Any new event, which occurs after the point has captured a timestamp, is dropped until the stored events have been acknowledged.

If latching is disabled in Point mode, new events overwrite old events when they are received. In FIFO mode, up to 256 events (for all points that are configured as FIFO inputs) are buffered before events are overwritten. Therefore, if inputs change rapidly, events could be lost in the module or in the controller before the ladder logic operates the event.

When events are lost (old events overwritten or new events ignored due to latching) an *EventOverflow* bit is set for each point that loses an event. The *EventOverflow* bit clears when you acknowledge the events that is blocking for that point are acknowledged.

Timestamping is a feature that registers a time reference to a change in input data. For the ArmorBlock 5000 16-channel configurable digital I/O module, the time mechanism that is used for timestamping is (PTP) system time. The configurable digital I/O module is a PTP slave-only device. There must be another module on the network that functions as a master clock.

High-Performance Sequence of Events Applications in the Logix Architecture

Sequence of Events (SOE) applications span a wide range of industry applications. Typically, any event that must be compared against a second event can be classified as SOE.

- Used on discrete machines to identify failure points
- Used in Power Substations or power plants to indicate first fault conditions
- Used in SCADA applications to indicate pump failures or other discrete events
- Used in motion control applications to increase control coordination
- Used in high-speed applications
- Used in Global Position Registration

In today's environment, specifications for SOE applications typically require 1 ms or better resolution on timestamps. There are two types of SOE applications.

- First Fault – Measures the time between events with no correlation to events outside of that system.
- Real Time – Captures the time of an event occurrence as it relates to some master clock. Typically, this is a GPS, NTP server, or some other accurate clock source. This method allows distributed systems to capture events and build a history of these events. These events are almost always digital; however, some are analog for which lower performance requirements can be configured.

First Fault Detection

An example of first fault detection would be intermittent failure from a sensor on a safety system that faults a machine and halts production, which in turn cascades a flood of other interrelated machine faults. Traditional fault detection or alarms may not appear in the correct timed order of actual failure, which makes it difficult or impossible to identify the root cause of the downtime.

Timestamped I/O

High precision timestamps on I/O allow accurate first fault detection, which makes it easy to identify the initial fault that causes the machine downtime.

Common time base for an alarming system logs user interaction and alarm events with common time reference.

The power industry requires sub 1 ms accuracy on first fault across geographically dispersed architecture.

High-Speed Applications

Packaging machines or sorters that have fast part cycles often bottleneck due to controller scan times. If you switch to a time-based solution, you can remove many scan time critical components of the system. This programming technique allows you to do predictive events and schedule outputs to run things like diverters without having a scan time to match the part cycle time.

Motion Control

CIP Sync also provides a common time reference for distributed variable-frequency drives (VFD), servos, and controllers throughout the system. This allows controllers to request axes, reach a pre-defined position at a known time reference, or run at a set speed with the same reference. Since all drives and controllers in the system have the same reference to time, the controller can issue simple requests for axes to reach target positions in a synchronized fashion.

Global Position Registration

Registration refers to a function performed by the drive where a physical input is triggered and causes the drive to capture precisely the actual axis position when the input event occurs. Rather than wiring inputs to the registration input on all drives, this time-based system lets you wire an input to only one time-based SOE input module. The motion planner can use the timestamp returned for that input to calculate the actual axis position at the time the input is triggered. This simplifies a system installation, reduces wiring costs, and provides a global machine registration for all axes in the system through one SOE input.

16-point and 8-point Mode

The ArmorBlock 5000 16-channel configurable digital I/O module has a total of eight ports that are labeled as PO...P7 on the module. Each port has two points that are associated with it for a total of 16 points (point 00 to point 15) on the module. The channels are labeled as CO...C15 on the module. The channels are grouped in ascending order and associated to their respective ports based on point mode selection.

The ArmorBlock 5000 configurable digital I/O module can be configured to operate in either 8-point mode or 16-point mode. Configure the point mode from the Device Definition Overview view as shown in [Figure 2](#).

Figure 2 - Device Definition Overview View

The screenshot shows the 'Device Definition' window with the 'Overview' tab selected. The configuration details are as follows:

- Device type:** 5032-CFGB16M12M12LDR 5032 16pt Digital CFG L Coded
- Series:** A
- Name:** MyCfGb16Module
- Revision:** 2, 011
- Description:** My 5032 CFGB16 Module
- Electronic keying:** Compatible Module
- Points:** 16 (highlighted with a blue circle)
- Ethernet Address:** Private network, 192 . 168 . 1 . 111
- Connection:** Data with Events and Ethernet ...
- MAOC Compatible Data:** No
- Timestamp:** Per Point

Buttons at the bottom right: OK, Cancel, Help.

IMPORTANT Point mode selection is not enabled when the Connection type is set as "Scheduled Output" or "Scheduled Output and Status".

8-point Mode

If you configure the ArmorBlock 5000 16-channel configurable digital I/O module in 8-point mode, the total available points that you can use for the module in an application is set to 8. In 8-point mode, each port has one active point and one disabled point. Only pin 4 of the M12 A-coded connector can be configured as an I/O signal.

In 8-point mode, each port is assigned only one point. Point 01 belongs to Port 1, Point 02 belongs to Port 2, and so on, as shown in [Figure 3](#).

Figure 3 - Device Definition Point Assignments View for 8-point Mode

Port	Point	Selected Mode	Fast
0	00	Digital Input	✓
1	01	Digital Input	✓
2	02	Digital Input	✓
3	03	Digital Input	✓
4	04	Digital Input	
5	05	Digital Input	
6	06	Digital Input	
7	07	Digital Input	

16-point Mode

If you configure the ArmorBlock 5000 16-channel configurable digital I/O module in 16-point mode, all 16 points of the module are enabled and you can use all 16 points in an application. In 16-point mode, the first two points (Point 00 and Point 01) belong to Port 0. Point 02 and Point 03 belong to Port 1, and so on, as shown in [Figure 4](#).

Figure 4 - Device Definition Point Assignments View for 16-point Mode

Port	Point	Selected Mode	Fast
0	00	Digital Input	✓
0	01	Digital Input	✓
1	02	Digital Input	✓
1	03	Digital Input	✓
2	04	Digital Input	✓
2	05	Digital Input	✓
3	06	Digital Input	✓
3	07	Digital Input	✓
4	08	Digital Input Output, Timestamp	
4	09	Digital Input Output, Timestamp	
5	10	Digital Input Output, Timestamp	
5	11	Digital Input Output, Timestamp	

Listen Only Mode

Any controller in the system can listen to the data from an I/O module. An owner-controller, as described in [Ownership on page 13](#), exchanges data with I/O modules.

Other controllers can use a Listen Only connection with the I/O module.

In this case, the 'listening' controller can only listen to input data or 'echoed' output data.

The listening controller does not own the module configuration or exchange other data with the module.

During the I/O configuration process, you can specify a Listen Only connection.

There are the following Listen Only connection constraints:

- Scheduled Output connection does not support a Listen Only connection.
- When the owner connection is data or data with events, you can only establish a Listen Only connection if the point selection modes match the point selection modes of the owner controller for all points on the Listen Only controller.

For more information on Connection options, see [Device Definition - Overview on page 54](#).

Protection Mode

The Protection Mode is a state where the device is operational, but has implemented defenses against disruptive changes that would take the product out of service for the process. There are two types of Protection Mode: Implicit and Explicit. These modes differ in how a device is entered in such state and what type of action is prohibited in each of these modes.

An Implicit Protection Mode is a security enhancement that is automatically triggered as soon as I/O connection to the module is established.

An Explicit Protection Mode is a security enhancement that is triggered when a certain rotary switches pattern is selected (see [Enter and Exit Explicit Protection Mode on page 26](#)). The security enhancement occurs on the module level and helps prevent unauthorized configuration changes that can affect system behavior and cause unintended and unforeseen changes.

Enter and Exit Implicit Protection Mode

The module enters Implicit Protection Mode as soon as I/O connections are established to the module. The module exits Implicit Protection Mode as soon as all I/O connections to the module are stopped.

Enter and Exit Explicit Protection Mode

The module enters Explicit Protection Mode when rotary switches are set to value 900 during power up.

To enter Explicit Protection Mode, do the following:

1. Note the current position of the rotary switches.
2. Power down the device.
3. Set the rotary switches to 900, then power up the device.

The module confirms entering into Explicit Protection Mode and updates the status indicator sequence as follows:

- Module status indicator = Flashing red
- All other indicators = Off

4. Power down the device and restore previous values to the rotary switches.
5. Power up the device to normal operation with Explicit Protection Mode enabled.

To exit Explicit Protection Mode, do the following:

1. Note the current position of the rotary switches.
2. Power down the device.
3. Set the rotary switches to 000, then power up the device.
The adapter confirms exiting Explicit Protection Mode and updates the status indicator sequence as follows:
 - Module status indicator = Flashing red
 - All other indicators = Off
4. Power down the device and restore previous values to the rotary switches.
5. Power up the device to normal operation with Explicit Protection Mode disabled.

Restrictions Imposed By Implicit Protection Mode

Protection Mode helps prevent access to services that are not required after the device is configured and in normal operation. Protection Mode disables features that can make the device vulnerable to disruptive actions. By doing so, Protection Mode helps to reduce the attack surface.

When it is in Implicit Protection Mode, the module prevents execution of the following tasks:

- Change Ethernet configuration settings, such as port speed
- Change IP settings, such as IP address, mask, and DHCP mode
- Disable or re-enable Ethernet ports
- Update the module firmware revision
- Perform remote module resets
- Disable or enable the secure web server
- Change point operation mode
- Disable or enable the SNMP Agent
- Web server configuration pages cannot be updated

Restrictions Imposed By Explicit Protection Mode

Protection Mode helps prevent access to services that are not required after the device is configured and in normal operation. Protection Mode disables features that can make the device vulnerable to disruptive actions. By doing so, Protection Mode helps to reduce the attack surface.

When it is in Explicit Protection Mode, the module prevents execution of the following tasks:

- Change Ethernet configuration settings, such as port speed
- Change IP settings, such as IP address, mask, and DHCP mode
- Disable or re-enable Ethernet ports
- Update the module firmware revision
- Perform remote module resets
- Change configuration on QoS and Time Sync
- Disable or enable the secure web server
- Disable or enable the SNMP Agent
- Web server configuration pages cannot be updated

Perform Tasks When Restricted

If the module is in Protection Mode and you attempt to perform any of the restricted tasks, you are alerted that such a task cannot be performed because the module is in Protection Mode.

IMPORTANT Protection Mode restrictions are not configurable.

If the module is not in Protection Mode, the module accepts the attempts to perform the tasks that are described previously.

For example, after the module is initially powered up, but no I/O connections are established yet, the module is not in Implicit Protection Mode. As long as you are not in Explicit Protection Mode, you can attempt to update the module firmware revision and the module accepts the attempt.



If the module enters Protection Mode each time the module powers up, check the application controllers to determine if there are active I/O connections that are opened through the module.

Custom IP Address

The ArmorBlock 5000 16-channel configurable digital I/O module allows you to set a Custom IP address with Custom IP Prefix, Attribute #101 of the TCP/IP object.

The values in this attribute are used to fill:

- The most significant 3 bytes of the IP address
- The entire Network Mask and Gateway Address of an IP configuration

You can only set a custom IP address when the switch value is in the 1...254 range (inclusive).

The last octet of the IP address is taken from the network address switches value.

You can also update the custom IP address using the web server.

Note: You must cycle power to the module in order for the updated custom IP address to take effect.

Syslog Event Logging

The ArmorBlock 5000 16-channel configurable digital I/O module supports syslog event logging.

Choose a syslog collector that supports the following:

- RFC-5425 syslog protocol
- Ability to receive messages from the ArmorBlock 5000 16-channel configurable digital I/O module

IMPORTANT The ArmorBlock 5000 16-channel configurable digital I/O module must be connected to the same network as the syslog collector.

Input Point Features

This chapter describes input point features that are supported on the ArmorBlock 5000 16-channel configurable digital I/O module.

Software Configurable Input Filters

You can adjust On-to-Off and Off-to-On filter times through the Studio 5000 Logix Designer application for all digital input points. These filters improve noise immunity within a signal.

A larger filter value affects the length of delay times for signals from these modules. The filter values are adjustable in the individual input points view of the Module Properties window.

Table 6 - Digital Input Filter

Filter Time Off > On	Filter Time On > Off
0 μ s	0 μ s
5 μ s	5 μ s
10 μ s	10 μ s
20 μ s	20 μ s
50 μ s	50 μ s
100 μ s	100 μ s
500 μ s	500 μ s
1 ms	1 ms
2 ms	2 ms
5 ms	5 ms
10 ms	10 ms
20 ms	20 ms
50 ms	50 ms

To set the input filter values, see [Points View on page 60](#).

The input filter is implemented with a step filtering algorithm, which means that an input signal must remain in the new state for at least the filter time duration before the transition is valid and the input changes state.

If the input state fluctuates, it may take a longer time to determine if the transition is valid. If the input changes state again before the chosen input filter time elapses, the transition is not valid.

Input and Event timestamps are only recorded with valid transitions.

Chatter Detection

Chatter Detection is a feature that is directly related to Timestamping. You use the feature to detect when a device that is connected to the module input causes chatter.

Chatter occurs when the device causes the inputs to transition falsely many times in a relatively short period. As a result, the module timestamps invalid input transitions.

You can configure the following:

- Chatter Count – Determines the number of acceptable input transitions that can occur in a given time period before considering the input to be chatter
Valid chatter count values range from 2...127.
- Chatter Time – Determines the amount of time within which the number of input transitions are counted
Valid chatter time values range from 1...10000 ms.

To set the Chatter Detection options, see [Ptxx - Input, Timestamp on page 62](#).

Sensor Side Short Circuit Detection

Short circuit protection helps prevent damage that can result from driving a current from the point greater than the maximum current level that the point can handle.

[Figure 5](#) shows the short circuit conditions and protections that are provided on the different ports.

Figure 5 - Sensor-side Short Circuit Protection

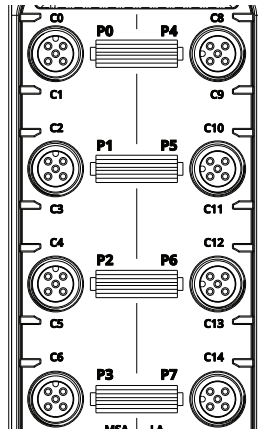

Ports	Short Circuit Conditions with Protection	Description
0, 1, 2, 3	MSA SSV Short Circuit	Short between pins 1 and 3
4, 5, 6, 7	LA SSV Short Circuit	Short between pins 1 and 3

When a short circuit condition is detected, the following occurs:

- The point limits the input current and monitors for the short circuit condition to be removed.
- The I/O status indicator for the point flashes red.
- The *I.Ptx.Fault* tag is set to 1.

Check the point diagnostic or retrieve the information from the diagnostic assembly to verify that the short circuit condition is present.

When the short circuit condition is removed, the following occurs:

- The point restarts in its commanded state.
- The I/O status indicator for the point turns back to steady yellow.
- The *I.Ptx.Fault* tag is reset to 0.

Check the point diagnostic or retrieve the information from the diagnostic assembly to verify that the short circuit condition is removed.

To check the point diagnostics, see [Points View on page 60](#).

For more information on how to retrieve diagnostic assemblies, see [Diagnostic Assemblies on page 101](#).

For more information on using module tags, see [Configurable Digital I/O Module Device Definitions on page 89](#).

Group Short Circuit

When one of the group short circuit points experiences a short circuit condition, the other points experience the same fault, and the fault bit is cleared when the fault is removed. The point configured as input in the group will flash red.

Fault and Status Reporting

The module sends fault and status data with point data to the controller. The data is returned through module tags that you can monitor in your Studio 5000 Logix Designer application.

The ArmorBlock 5000 16-channel configurable digital I/O module provides the fault and data status in a point-centric format.

[Table 7](#) lists the fault and status tags that are available for the configurable digital I/O module points in the Studio 5000 Logix Designer application.

Table 7 - Fault and Status Tags for ArmorBlock 5000 16-channel Configurable Digital I/O Module Points

Data Type	Tag Name	Triggering Event That Sets the Tag
Fault	Ptxx.Fault	The point data quality is bad.
	Counterxx.Fault	The counter data quality is bad.
Status	Ptxx.Data	The point input status is 0 or 1.
	Counterxx.Data	The counter input status is 0 or 1.

We recommend that you monitor the tags in your program to make sure that the application is operating as expected.

IMPORTANT Once the condition that causes the Fault or Uncertain tag to change to 1 is removed, the tag automatically resets to 0. The Studio 5000 Logix Designer application controls the tags. You cannot change the status of the tags.

Remember that in some system configurations, the tag is not reset immediately after the condition is removed. The tag typically resets after a short delay.

[Table 8](#) lists the conditions that are shown in the point diagnostics and diagnostic assemblies.

Table 8 - Diagnostic Conditions

Diagnostic Condition	Description
SAPowerFault	Indicates whether a fault exists on SA power
SAPowerFaultTimestamp	The most recent time a fault on SA power occurred
LAPowerFault	Indicates whether a fault exists on LA power
LAPowerFaultTimestamp	The most recent time a fault on LA power occurred
MSASSVShortCircuit	Indicates whether a short circuit or overcurrent condition exists on MSA SSV power
MSASSVShortCircuitTimestamp	The most recent time a short circuit or overcurrent condition on MSA SSV power occurred
LASSVShortCircuit	Indicates whether a short circuit or overcurrent condition exists on LA SSV power
LASSVShortCircuitTimestamp	The most recent time a short circuit or overcurrent condition on LA SSV power occurred
ShortCircuit	Indicates whether a short circuit condition exists
ShortCircuitTimestamp	The most recent time a short circuit condition occurred

For more information on fault reporting, see [Troubleshoot Your Configurable Digital I/O Module on page 81](#).

IMPORTANT Wire the outputs ensuring that there is no short at the outputs or loads. If there are multiple simultaneous short circuit conditions present, the module power could dip below operating condition.

Input Counter

All 16 points can be configured as counter.

The counter supports the following features:

- Up counter
- Counts up to a user configured Preset
- When preset is reached the counter does one of the following:
 - Rollover to 0 and start counting from 0
 - Continue counting from the Preset value and rollover at 2,147,483,647
 - Set the Done bit when the counter is greater than or equal to the Preset
 - Count can be set to 0 via a reset bit in the output tags
- Fast I/O port points count input pulses up to 33 kHz^{(a)(b)}
- Standard I/O port points count input pulses up to 2.5 kHz

Sequence of Events

ArmorBlock 5000 16-channel configurable digital I/O module can be configured to timestamp two transitions per input, one in each direction (Off-to-On and On-to-Off). When specific points that are Timestamp Capture-enabled transition (for example, input 1 is configured so that Timestamp Capture is enabled for Off-to-On transitions and the input turns on), the module timestamps the transition with the current system time value on the network. The module produces data for the owner-controller the RPI after the input filter criteria and chatter detection criteria have been met and at subsequent RPIs.

Operational Modes

The ArmorBlock 5000 16-channel configurable digital I/O module operates in First-In-First-Out (FIFO) and Per Point modes:

- FIFO – In FIFO mode, the module timestamps multiple input transitions on any Timestamp Capture-enabled input. The module stores the timestamp data in on-board buffers that hold 256 timestamp events. All 16 points share the same buffer.
- Per Point Mode – The module, when configured as "Digital Input, Timestamp", produces timestamps for up to 2 input transitions per input, one for Off-to-On transitions and another for On-to-Off transitions; these timestamps can occur simultaneously on separate inputs.

Timestamp Latching

With the ArmorBlock 5000 16-channel configurable digital I/O module you can enable Timestamp Latching to prevent the module from overwriting input data once it is timestamped.

- If Timestamp Latching is enabled, the module timestamps an input in a given direction and ignores future input transitions in that direction until the controller acknowledges the timestamp data already received.
- If Timestamp Latching is disabled, the module timestamps every input transition and may overwrite previously recorded timestamp data if the controller does not acknowledge the data quickly enough.
- This feature is set on a module-wide basis when the module is in FIFO mode. Once the latch is enabled, the 256-event buffer is latched and cannot be overwritten unless the owner controller acknowledges the events.
- In Per Point mode supports Timestamp Latching on a per point basis.

(a) Counter counts are affected by the filter value chosen and any of the other points on the fast side are configured as FIFO.
 (b) When no filter is applied for the counter mode point, 33 kHz should be achievable irrespective of the other point configuration.

Input FIFO

You can configure all 16 points on the ArmorBlock 5000 16-channel configurable digital I/O module as FIFO.

When specific points that are Timestamp Capture-enabled transition from Off to On or On to Off, the module timestamps the transition with the current system time value on the network. In addition to the 256 on-board buffer, FIFO has a produce buffer for 20 events that are produced for the owner-controller at the RPI after the input filter criteria are met, and at every subsequent RPI.

When an input transitions, the module timestamps the event and records specific input data related to the transition. The owner-controller must retrieve the data from the Sequence of Events module using one of the two methods described in [Retrieve Data in FIFO Mode on page 35](#).

IMPORTANT Keep in mind that, although the Sequence of Events module can store data for up to 256 timestamped transitions in its on-board buffers, if you manage the buffer effectively (for instance, retrieve data in a timely fashion), the module can timestamp an infinite number of input transitions and the controller is able to retrieve and use the data.

Configure the Module for FIFO Mode

During module configuration, you must choose one of the following communication formats for the module to operate in FIFO mode.

- **Connection**
To operate the Sequence of Events module in FIFO mode, you must choose a connection type that supports FIFO point mode.
 - Data
 - Data and Ethernet Status
- **Timestamp**
Set to FIFO mode
- **Points**
Determines the number of points used as FIFO. You can configure 16 points in 16-point mode and 8 points in 8-point mode.
- **Point Assignment**
Determines the selected mode for the point (Input/Counter/FIFO)
- **Enable FIFO Event Latching**
Determines whether the on-board 256 events buffer is latched or unlatched
- **Timestamping**
Determines whether the timestamp capture for the point is enabled or disabled
- **Chatter Detection**
Determines if chatter detection is enabled and configured

On-board Buffer in FIFO Mode

The module stores up to 256 events and produces up to 20 events. Once data is stored in the module, the controller must retrieve it. Typically, the controller retrieves data from the first slot in the on-board buffer; the data in the first slot is also known as the current event.

IMPORTANT The current event is the event for which the Sequence of Events module is currently producing data. The current event is NOT the most recently timestamped input transition.

After the controller retrieves the current event data, it acknowledges the data and clears it from the module on-board buffers. The data from the next slot in the buffer becomes the current event (the module produces this data for the controller). The controller can retrieve up to 20 events at once and acknowledge^(a) them^(b).

In FIFO mode, generally the following occurs:

1. You configure the module to operate in FIFO mode via the Communication Format selection.
2. The module timestamps each transition and stores the data in its on-board buffer. The module can timestamp each transition with a unique timestamp if the transitions occur 20 μ s apart from one point to another.
3. The controller retrieves data from the module as described in the following steps:
 - a. Immediately after the module timestamps an input transition, it records data in the first slot of its on-board buffer; the data is the current event. The controller can retrieve the current event from its on-board buffer. The module produces the retrieved data every subsequent RPI until the controller acknowledges it.
 - b. The controller copies the data from the controller tags to a separate data structure for later use.
 - c. The controller acknowledges the current event in the module buffer by copying *I.EventNumber* to *O.EventNumberAck*.
 - d. Once the current event is cleared from the module buffer, data for the next transition stored in the buffer becomes the current event, and the module begins producing this data for the controller as described in [Step a](#).
4. The module timestamps input transitions and records the data in its on-board buffer as long as the buffer is not full. The module stores up to 256 events.

Typical Applications of FIFO Mode

FIFO mode is intended for use in applications where multiple transitions occur on multiple inputs in relatively rapid succession (faster than the controller can acknowledge the data as the transitions occur). Because of this intention, the module uses an on-board buffer to store the data for up to 256 events per input.

Examples of typical FIFO mode applications are:

- Sequence monitoring
- Process and machine optimization

(a) The controller *EventNumberAck* tag should match any one of the *EventNumber* tags in the FIFO produce buffer for the module to acknowledge. If *EventNumberAck* does not match *EventNumber*, the module takes no action.

(b) All events in the produce buffer that are less than or equal to *EventNumberAck* are acknowledged at once. Events greater than *EventNumberAck* is not acknowledged and is produced at the RPI interval until is acknowledged.

Manage Data in FIFO Mode

In FIFO Mode, the Sequence of Events module sends input data for the current event to the controller immediately after the first input transition has been timestamped and at each RPI. You must manage the data coming from the Sequence of Events module.

The following occurs in the process of the managing data coming from the Sequence of Events module in FIFO mode:

1. The controller retrieves current event data from the Sequence of Events module in one of two retrieval methods.
2. The controller copies the relevant portions of the current event data to a separate array.
3. The controller clears current data from the Sequence of Events module by copying the current event number *I.EventNumber* to the *O.EventNumberAck* tag, to prepare the module to send data from the next current event.

Retrieve Data in FIFO Mode

In FIFO Mode, the controller must retrieve the data for the timestamped transitions in the module buffers.

The controller can retrieve data in one of the following ways:

- [Standard Retrieval](#) – By default, the module uses this retrieval method that returns events in order of occurrence.
- [Retrieval by Point](#)

Standard Retrieval

In Standard Retrieval, the controller retrieves the data for each event in the order that the events occur. This retrieval method includes the following:

1. At each RPI, the module produces the current event in its on-board buffer.
2. The controller copies relevant input data from the current event to a separate data structure for later use.
3. The controller clears the current event from the module on-board buffer by acknowledging the data via the module output word.
4. When the current event is cleared, the next event in the module on-board buffer becomes the new current event. If no other events are present, the event data is 0.
5. The module produces the new current event as described in [Step 1](#). The controller can retrieve up to 20 events at a time and acknowledge them.

The retrieval process continues as long as the module timestamps input transitions, and as long as the controller continues to retrieve the data for each transition.

Produce Current Event Data

[Figure 6](#) shows an example of the Sequence of Events module producing the current data for the controller to retrieve.

IMPORTANT

Remember, the current event is data that the module is currently producing from its on-board buffer at each RPI. For more information on how the Sequence of Events module produces data from its on-board buffer, see [On-board Buffer in FIFO Mode on page 34](#).

Figure 6 - Sequence of Events Module Produces Current Data

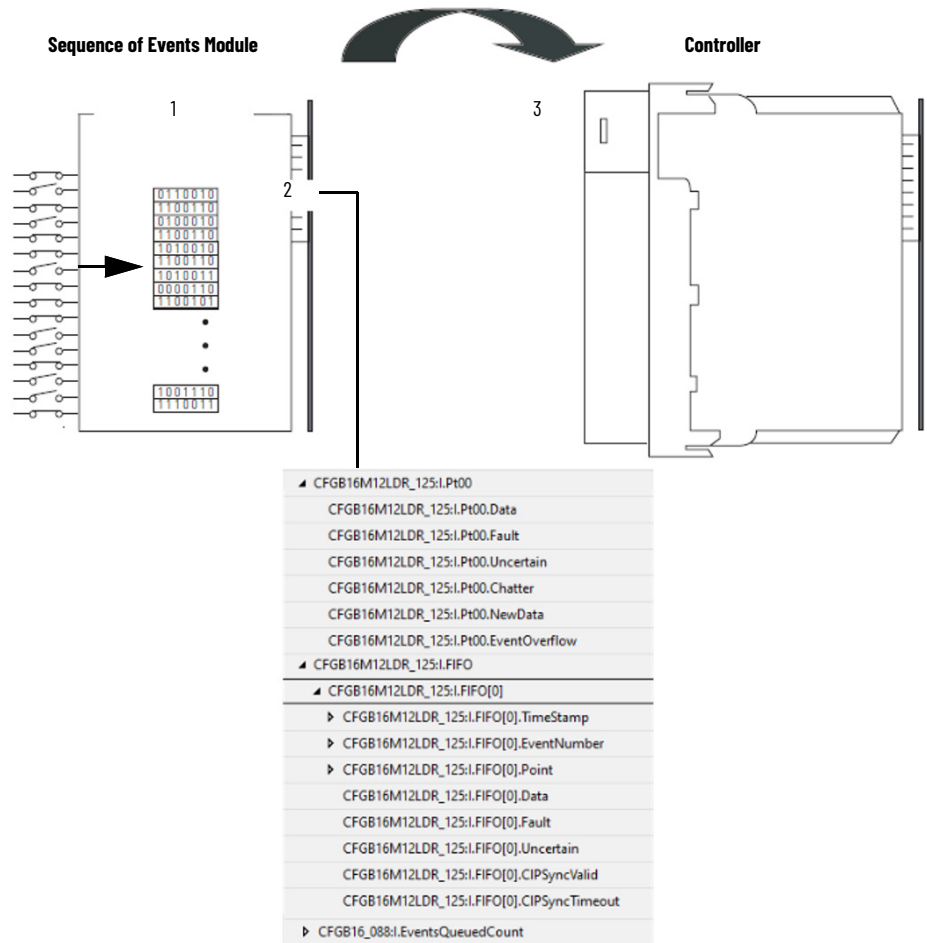

1. The Sequence of Events module stores data in the on-board buffer.
2. The module produces the current event data.
3. The controller retrieves the current data.

Copy Relevant Input Data to a Separate Data Structure

At each RPI, the Sequence of Events module sends input data for the current event to the controller; the data is stored in the controller tags. We recommend you use a COP or CPS instruction to programmatically copy relevant input data from the controller tags to a separate array in the controller memory.

IMPORTANT

When the Sequence of Events module sends current event data at the RPI, it sends data for all the FIFO tags (see [Input Tags on page 92](#)). However, you typically only need data from specific tags. We recommend that you copy data from those tags to a separate array. For example, if you need data from the following tags for your application copy the data from those tags to a separate array:

- Event Timestamp (*I.FIFO[x].TimeStamp*)
- Event number (*I.FIFO[x].EventNumber*)
- Event point (*I.FIFO[x].Point*)
- Event data (*I.FIFO[x].Data*)

Later, you can combine data from multiple Sequence of Events modules and use a Sort routine to determine the order of events, with relative time reference, that occur in a specific period.

[Figure 7](#) shows when to use the COP or CPS instruction. In this example, the Sequence of Events module has produced current event data for the controller at the RPI.

The controller copies the relevant input data from the controller tags to a separate data structure.

Figure 7 - Controller Copies Relevant Input Data

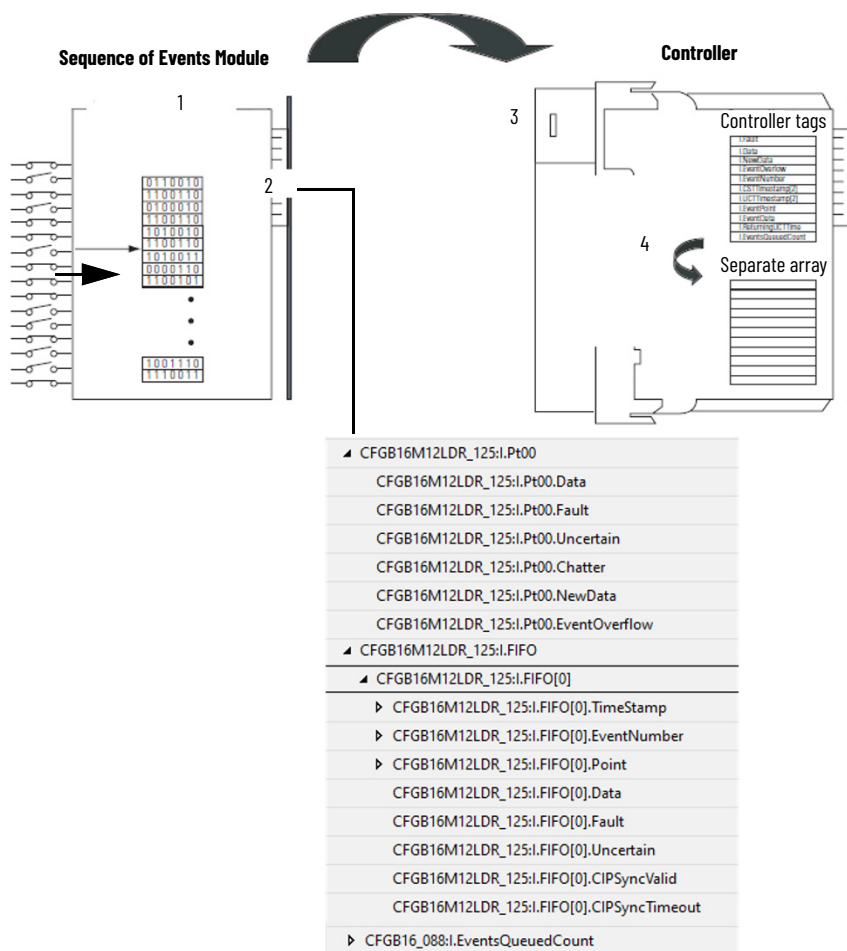

Your application determines what input data should be copied from the controller tags to a separate data structure. Although you can copy all the input data to another array, typically, only the data from specific tags is copied.

Figure 8 shows an example of ladder logic in which the controller only moves the Off-to-On timestamp data for inputs 0...3 from the controller tags to a separate data structure named “myarray”. The data in the “myarray” structure is then moved to another array used to sort the data. In this example, 32 bits of each 64-bit timestamp are moved to the new array.

Figure 8 - Ladder Logic Example

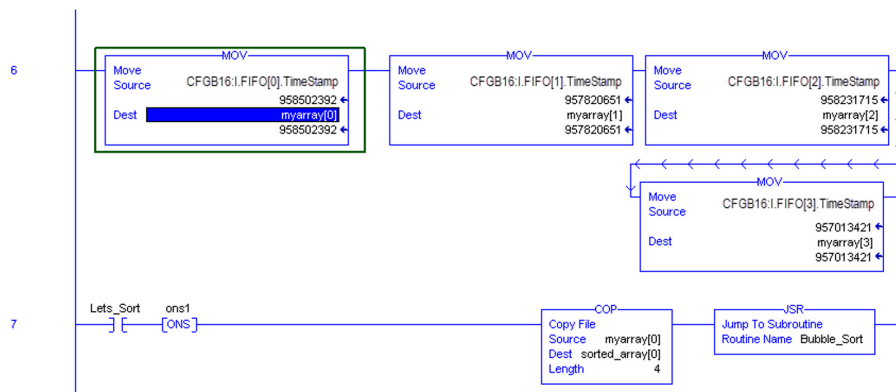

Acknowledge FIFO Events Latching

In FIFO mode, the Sequence of Events module produces data for the current event data at each RPI until the data is acknowledged and, thus, cleared from the buffer.

To clear data for the current event, and begin producing data for the next event in the Sequence of Events module's on-board buffer when using Standard Retrieval, you must copy the event number from the current event (located in the *I.EventNumber* tag) to the module's *EventNumberAck* tag (for instance, *O.EventNumberAck*).

[Figure 9](#) shows how to clear data for the current event from the Sequence of Events module. In this example, the controller has copied relevant input data from the controller tags to a separate data structure. The controller may use a COP or MOV instruction to copy the current event number to the Sequence of Events module's *O.EventNumberAck* tag and clear the data from the module's on-board buffer.

Figure 9 - Controller Copies Relevant Input Data

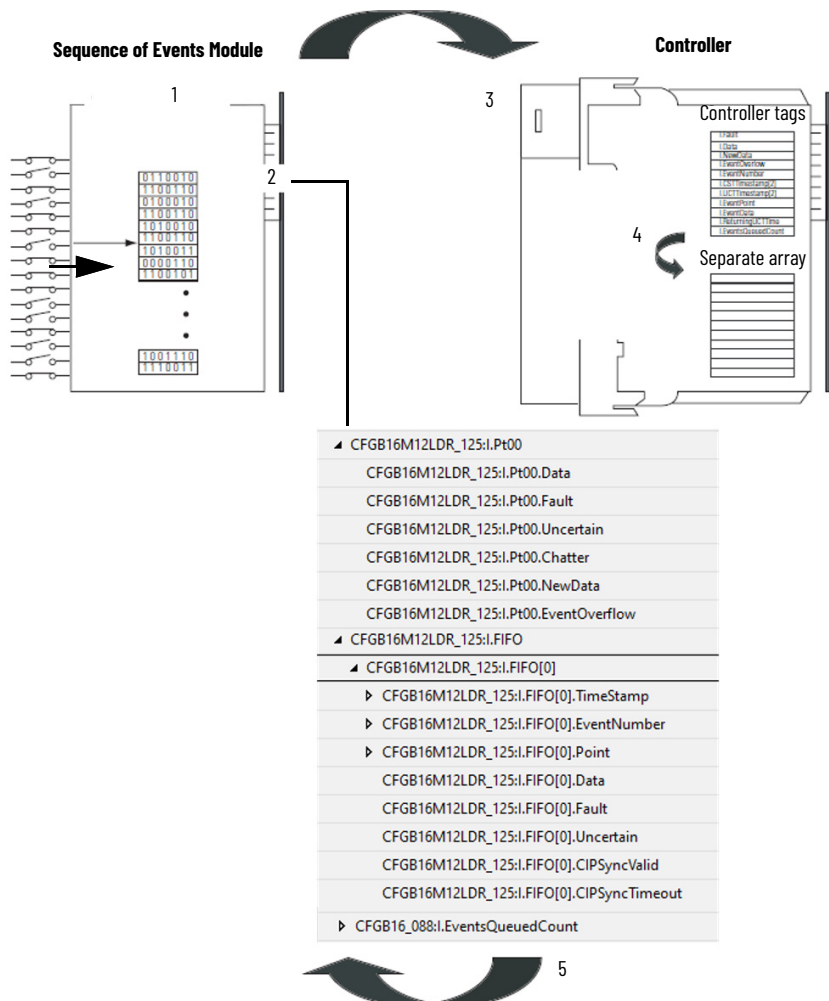

- To clear the current event from the Sequence of Events module buffer, the controller copies the current event number *I.EventNumber* to the *O.EventNumberAck* tag.

Once the current event data is cleared from the Sequence of Events module's buffer, the module begins to produce data for the next event in its buffer at each RPI because that event has become the current event. At this point, the process returns to [Produce Current Event Data on page 35](#).

FIFO Performance Characteristics

When you operate the module, you must account for delays that exist during internal processing that are inherent to the module. [Table 9](#) determines the maximum signal that the module can process based on the number of points configured as FIFO.

Table 9 - FIFO Performance

Configuration ⁽¹⁾	Fast I/O Ports	Standard I/O Ports
	Frequency (kHz)	Frequency (kHz)
16-point FIFO	5	2.5
16-point FIFO with PointToRetrieve enabled	2.5	2.5
8-point FIFO (Fast I/O ports)	10	—
8-point FIFO with PointToRetrieve enabled	4	
1-point FIFO (Fast I/O ports)	25	
1-point FIFO with PointToRetrieve enabled	14	

(1) Performance of FIFO mode varies based on the number of points configured as FIFO.

Note: Performance values shown are with input filter set to 0 μ s.

Retrieval by Point

Retrieval by Point is similar to Standard Retrieval by time except that with this method, the controller only retrieves timestamp data for input transitions that occurred on a specific point.

The module still timestamps input transitions for any events that occur on Timestamp Capture-enabled inputs. The module stores up to 256 events.

IMPORTANT

The module stores up to 256 events. You must manage the module buffer effectively to make sure that the module timestamps all transitions on a specific input.

Consider the following example:

You use Retrieve by Point to retrieve timestamp data from input 4, and 10 of the first 40 input transitions that the Sequence of Events module timestamps occur on input 4.

If FIFO event Latch is enabled for the module and you fail to clear any of the timestamp data for input 4 before the input transitions again, the Sequence of Events module does not timestamp the next transition for input 4, even though there are 216 slots still available in the module's on-board buffer.

Additional Module Settings Required with Retrieval by Point Method

By default, the module operates as though the controller uses Standard Retrieval to retrieve data. To use the Retrieval by Point method, you must change the following two tags in the module output word:

O.RetrieveByPoint = 1 (default value is 0)

O.PointToRetrieve = Input point for which you want the controller to retrieve data. For example, if you want to retrieve the data for input 8, change this tag to 8.

Retrieval Process Similar to Standard Retrieval

After you make the output tag changes listed in [Additional Module Settings Required with Retrieval by Point Method](#), the controller retrieves the data for each transition on the specified input in the order in which the transitions occur.

The only exception to the process is that in Retrieval by Point, the current event is not necessarily the data in the first slot of the on-board buffer. Instead, the current event is the first slot (up to 256 events) that contains data for a transition timestamped at the specified input.

For example, if you are using Retrieval by Point to retrieve data for input 7 and the first transition that occurs on input 7 is the 5th transition the module timestamps, the current event is located in slot 5 of the module on-board buffer.

Change Between Retrieval Methods

When using the module in FIFO mode, you may determine that you need to change retrieval methods. Before you can change retrieval methods, consider the following:

- The change does NOT take effect until all events are acknowledged or cleared from the module produce buffers.
- When you change retrieval methods dynamically, ideally you acknowledge events in the module produce buffers and immediately switch FIFO retrieval modes.

To change retrieval methods, change the *O.RetrieveByPoint* tag to the new method.

- To use the Standard Retrieval by time method, *O.RetrieveByPoint = 0*
- To use the Retrieval by Point method, *O.RetrieveByPoint = 1*

Clear All Data from the Module's Buffers at Once

If necessary, you can reset the events in the Sequence of Events module's on-board buffers, in effect clearing all the data from previously timestamped transitions. In other words, when all the data is cleared from the module's buffers, all of the module's input tags return to 0, except data that is a live, filtered view of the inputs.

To reset events in the module's buffer, transition the *O.ResetEvents* tag to 1 as follows:

- If the bit = 0, change the bit to 1.
- If the bit = 1, change the bit to 0, wait for at least one RPI, and change the bit to 1.

Once the data is cleared, the module begins to timestamp input transitions normally and storing them in its on-board buffer.

Input Timestamp

In Per Point mode, the Sequence of Events module can be configured to timestamp two transitions per input, one in each direction (Off-to-On and On-to-Off).

When specific points are Capture-enabled (for example, input 1 is configured so that Enable Capture is enabled for Off-to-On transitions and the input turns on), the module timestamps the transition with the current system time value on the network. The module produces data for the owner-controller when the input filter and chatter detection criteria have been met and at subsequent RPIs.

With each timestamped transition, the Sequence of Events module stores data for that point.

The following are scenarios for Input Timestamp:

1. The module is installed, wired to input devices, and ready to begin operation. All inputs are configured to timestamp any transition that occurs.
At this point, timestamp data for each input is 0 because no input transitions occur.
2. The module is installed, wired to input devices, and ready to begin operation. All inputs are configured to timestamp any transition that occurs.
At this point, timestamp data for each input is 0 because no input transitions occur.

3. Input 2 transitions from On to Off.
The module timestamps the transition; the module sends the data to the owner-controller and stores it locally.

When the Sequence of Events module operates in Per Point mode, generally the following occurs:

1. You configure the Sequence of Events module to operate in Per Point mode via the Communication Format selection.
2. The Sequence of Events module timestamps each transition for inputs that are Timestamp Capture-enabled. The module can timestamp each transition with a unique timestamp if the transitions are 20 μ s apart.
3. The module sends all of its input data, including the new data from the most recent transition to the controller immediately after timestamping the transition and passing the input filter to verify that the transition is valid.
4. You copy new data from the controller tags to a separate data structure for later sorting.
5. Once the data is copied to a separate data structure, you sort the data in the controller to determine the order of events.

Typical Applications of Per Point Mode

Use Per Point mode in applications that need to determine relative first fault detection after an event cascade occurs. The Sequence of Events module can provide unique timestamps for separate input transitions as long as they occur 20 μ s apart. You can sort the data resulting from an event cascade to determine where the first input transition occurs in the cascade.

Examples of typical Per Point mode applications are:

- Substation automation
- Load-shedding/energy management
- Emergency shutdown systems

Configure the Module for Per Point Mode

During module configuration, you must choose the following connection format for the module to operate in Input Timestamp mode.

- **Connection**
To operate the Sequence of Events module in Per Point mode, you must choose below connection format that support Input Timestamp mode.
 - Data
 - Data and Ethernet Status
 - Data with Events
 - Data with Events and Status
- **Timestamp**
Set to Per Point mode
- **Points**
Determines the number points used as FIFO. 16 and 8 points can be configured in case of 16-point or 8-point mode respectively.
- **Point Assignments**
Determines the point selected mode (Input/Counter/Timestamp)
- **Enable Timestamp Latching**
Determines whether the input point timestamp is latched or unlatched
- **Input Filters**
Determines the filter time for Off-to-On or On-to-Off input transition

- **Timestamping**
Determines whether the timestamp capture for the point is enabled or disabled
- **Chatter Detection**
Determines if chatter detection is enabled and configured

Use Timestamp Latching in Per Point Mode

When enabled, Timestamp Latching prevents the Sequence of Events module from overwriting recorded timestamp data once a transition occurs. This feature is set on a per point basis. [Table 10](#) describes how Timestamp Latching affects the module in Per Point mode.

Table 10 - Timestamp Latching in Per Point Mode

Latch Status	Module Behavior
Enabled	<p>The Sequence of Events module timestamps two transitions for each input: One transition for Off-to-On and one for On-to-Off. If similar transitions occur on inputs where a transition is already timestamped and the data is not yet acknowledged, the module does not timestamp the new transition.</p> <p>When transitions occur that the Sequence of Events module does not timestamp, the module sets the <i>I.TimestampOverflowOffOn</i> tag (if an overflow happens on the Off-to-On transition) or <i>I.TimestampOverflowOnOff</i> tag (if an overflow happens on the On-to-Off transition) for that point to inform the controller that an input transitioned but that no timestamp is produced for the transition.</p>
Disabled	<p>The Sequence of Events module timestamps each transition for each input as they occur. When multiple transitions occur in the same direction on the same input, the module records the new timestamp data and overwrites any previously recorded data that has yet to be acknowledged.</p> <p>When the Sequence of Events module overwrites data, it sets the <i>I.TimestampOverflowOffOn</i> tag (if an overflow happens on the Off-to-On transition) or <i>I.TimestampOverflowOnOff</i> tag (if an overflow happens on the On-to-Off transition) for that point to inform the controller that events are overwritten.</p> <p>Timestamp Latching is disabled by default.</p>

IMPORTANT We recommend that you monitor the *I.TimestampOverflowOnOff* bit and *I.TimestampOverflowOffOn* bit so that you are aware of when transitions are not timestamped or when timestamp data is overwritten.

Use Enable Capture in Per Point Mode

Regardless of the operating mode, Enable Capture causes the Sequence of Events module to timestamp specific input transitions. However, keep the following in mind when using this feature in Per Point mode:

- If Latch is enabled, the module timestamps only the initial transitions (Off-to-On and On-to-Off) for each input provided that capture is enabled for both Off-to-On and On-to-Off.
- Whenever an input transition is timestamped as a valid transition, the module sends updated input data for all inputs to the controller immediately and at every subsequent RPI.

Manage the Data in Per Point Mode

In Per Point mode, the Sequence of Events module sends all of its input data to the controller after an input transition has been timestamped and at RPI rate. You must manage the data coming from the Sequence of Events module.

The following occurs in the process of the managing data coming from the Sequence of Events module in Per Point mode:

1. The Sequence of Events module sends data to the controller.
2. The controller copies the relevant portions of the input data to a separate array.
3. The controller clears latched timestamp data from the Sequence of Events module using the *O.TimestampOffOnNumberAck* tag or *O.TimestampOnOffNumberAck* tag, to prepare the module to timestamp the next transition.

Clear All Data from the Module's Buffers at Once

In Per Point Mode, if necessary, you can reset the events in the Sequence of Events module.

To reset events in the module's buffer, transition the *O.Ptxx.ResetTimestamps* tag to 1 as described below:

- If the bit = 0, change the bit to 1.
- If the bit = 1, change the bit to 0, wait for at least one RPI, and change the bit to 1.

Once the data is cleared, the module resumes timestamping input transitions again on a per point basis.

Pulse Latching

You can use Pulse Latching to detect or latch short duration pulses. Pulse Latching is supported through the Timestamping feature and Timestamp Latching.

To use Pulse Latching, you must complete the following:

- In the Device Definition dialog, configure the point as "Digital Input, Timestamp". See [Device Definition - Overview on page 54](#).
- On the Ptxx view for the point, select which input transitions you want to capture timestamps for.
- Select the Enable Timestamp Latching checkbox for the point. See [Ptxx - Input, Timestamp on page 62](#).

Notes:

Output Point Features

This chapter describes output point features that are supported on the ArmorBlock 5000 16-channel configurable digital I/O module.

- Output diagnostic
- Fast output point
- High current output point
- Output with pulse width modulation (PWM)
- Scheduled output
- Scheduled output with PWM

Time-scheduled Output Control

You can schedule times for module outputs to turn On or Off. The time schedules use units in nanoseconds. The timing of scheduled outputs for the ArmorBlock 5000 16-channel configurable digital I/O module is as follows:

- $\pm 10 \mu\text{s}$ accuracy
- 1 ns resolution

With firmware revision 2.011 or later, you can mix scheduled output with simple input when MAOC compatibility is required. When MAOC compatibility is not required, you can mix with any input mode.

The module must be time synced or schedules are not applied.

Time-scheduled output control is used with the Motion Arm Output Cam (MAOC) instruction. The MAOC instruction enables position-based output control in the following ways:

- Uses the position of any motion axis in a Logix 5000 control system as the position reference.
- Updates the outputs based on the motion axis position at the motion group coarse update rate of 1...32 ms.

The instruction can update standard output modules at the coarse update rate. However, some high-speed applications require a higher degree of accuracy.

The ArmorBlock 5000 16-channel configurable digital I/O scheduled output module improves the accuracy of the MAOC instruction by supporting the ability to schedule output On and Off times. All scheduling configuration for the On and Off times of an output is completed through the MAOC instruction. The instruction then updates values in the outputs of the module that define the scheduled output behavior.

Table 11 - Configurable Module Output Schedule Parameters

Feature	ArmorBlock 5000 16-channel Configurable Digital I/O Module
Number of schedules	32
Output points available for scheduling	16 (points 0...15)
Remote operation	–
Minimum schedule interval ⁽¹⁾	50 μs (Fast I/O ports) and 200 μs (Standard I/O ports)
Update rate	1...32 ms
Accuracy	$\pm 10 \mu\text{s}$ (For both Fast I/O and Standard I/O ports)
Resolution	1 ns

(1) The MAOC instruction limits the minimum schedule interval (minimum pulse width) to 1/16 of the coarse update period.

For information on how to use an MAOC instruction with the ArmorBlock 5000 16-channel configurable digital I/O module, see [Schedule Outputs Using MAOC on page 76](#).

Pulse Width Modulation

Pulse width modulation (PWM) provides precise, onboard control of an output's pulse train with no program variability. To configure a PWM signal, you define two real-time values for the pulse train in the module's output tags:

- **CycleTime** – The duration of a pulse cycle in seconds from 0.00001...30 seconds.
- **DutyCycle** – The pulse width or length of time that a pulse is active within a cycle. This can be defined in terms of percent of the cycle 0...100% of the cycle of Cycle Time.

If the CycleTime or DutyCycle is outside the valid range for an output, the corresponding bit in the input tag (for example, *I.PWMxx.Error*) is set, and the module responds as described in the following table.

Table 12 - Pulse Width Modulation Conditions

Condition	Result
CycleTime < 10.0E ⁻⁰⁶ s	CycleTime = 10.0E ⁻⁰⁶ s
CycleTime > 30.0 s	CycleTime = 30.0 s
DutyCycle < 0.0%	DutyCycle = 0.0%
DutyCycle > 100%	DutyCycle = 100%
On-time ⁽¹⁾ < 5 μs	DutyCycle = 0.0%

(1) On-time = (CycleTime x DutyCycle)/100

If the CycleTime or DutyCycle value changes while the output is generating a PWM signal, the changes are not applied until the next cycle of the PWM output.

If you use PWM with scheduled outputs, when you trigger a schedule to turn off the output, the last PWM signal completes its cycle before pulse generation stops.

There are other control parameters for PWM as described in the following table.

Table 13 - Pulse Width Modulation Control Parameters

Parameter	Description
Enable Pulse Width Modulation (PWM)	Determines whether the output is Pulse Width Modulation or Digital Output.
Enforce Duty Cycle at 50.0% for Pulse Train Output (PTO)	Determines whether to enforce the PTO-specific duty cycle, which is fixed at 50%. If enabled, <i>O.Pwmxx.DutyCycle</i> is ignored.
Enable Cycle Count Limit	Determines whether to generate a defined number of pulse cycles when there is a rising edge in the data or continuous pulse cycles when data is On. <ul style="list-style-type: none"> • 0 = Pulse cycles continue to occur until <i>O.Ptxx.Data</i> is set to 0. • 1 = Allow only a fixed number of pulse cycles to occur when there is a rising edge in <i>O.Ptxx.Data</i>
Execute All Cycles	Only applicable when Enable Cycle Count Limit is enabled. When <i>O.Ptxx.Data</i> transitions to 0: <ul style="list-style-type: none"> • 0 = Stop generating pulses immediately • 1 = Continue generating pulses until the Pulse Cycle Limit is reached
Cycle Count Limit	The number of pulse cycles to generate when there is a rising edge in the data. Only applicable when Enable Cycle Count Limit is enabled.

IMPORTANT PWM support is only as sourcing type.

IMPORTANT Before PWM functions, you must enable PWM during configuration and define the PWM cycle time and duty cycle in the output tags. If PWM is enabled (*C.PWMxx.Enable* = 1) and the output is instructed to turn on (*O.Ptxx.Data* = 1), the output generates a PWM signal, otherwise it behaves like a normal output.

IMPORTANT *O.Ptxx.Data* should be Off when changing CycleCountLimit, otherwise, one additional pulse might be generated.

Configure Point Output State When Module is in Program Mode or Inhibited

You can configure individual output points to specific states when the module is in Program mode or when the module is inhibited.

When the controller switches from Run mode to Program mode, the output can behave in the following ways, depending on how you configure the Output State in Program Mode parameter:

- Off - Default
- On
- Hold last state

IMPORTANT The Hold last state option is not applicable for “Output, PWM” and “Output, Scheduled, PWM” configurations. In these modes, outputs do not retain the last pulsed state when entering Program Mode or when the module is inhibited. Instead, Program Mode handling is applied.

When the module is inhibited, the output behavior follows the Output State in Program Mode configuration. If you set this parameter to On, the *O.Ptxx.Data* output tag for this channel is set to 1.

To configure the output states in Program mode or when the module is inhibited, see [Ptxx - Output on page 64](#).

Configure Point Output State in Communication Fault Mode

You can configure individual output points to specific states when a connection fault occurs, that is, the connection between the controller and the module breaks.

Output Behavior Immediately After a Connection Fault

When the connection between a controller and module breaks, the output can behave in the following ways, depending on how the Output State in Fault Mode parameter is configured:

- Off - Default
- On
- Hold last state

IMPORTANT The Hold last state option is not applicable for “Output, PWM” and “Output, Scheduled, PWM” configurations. In these modes, outputs do not retain the last pulsed state when entering Communication fault. Instead, Communication fault state handling is applied.

The output remains at that state value until the following occurs:

- The connection to the controller is re-established.
- The duration expired, which is based on the value that is defined in the “Fault Mode State Duration”.

Fault Mode State Duration After Connection Fault

For output behavior after a connection fault, you must define how long the output remains at the specified value before it transitions to a Final Fault State.

You can configure the output to remain at the specific value for the following times:

- Forever
- 1 second
- 2 seconds
- 5 seconds
- 10 seconds

After the Fault State Duration time expires, the output transitions to the user-defined Final Fault Mode State value.

Final Fault Mode State Value

The Final Fault Mode State value defines the value to which the output goes after the Fault Mode State Duration time expires.

Output State Once Connection is Re-established

Once the connection between the controller and module is re-established, the output resumes normal operation. To configure the output states in Fault mode, see [Ptxx - Output on page 64](#).

Point Output Short Circuit

When the output is switched on and there is an output short circuit condition present, the module:

1. Initiates the output to LOW.
2. Subsequently, every 5 seconds, evaluates the short circuit by switching the output to HIGH until the short circuit is resolved.
3. The point data that is produced remains consistent with the consumed point data, even when the physical output is LOW.

IMPORTANT Wire the outputs and verify that there is no short at the outputs or loads. If there are multiple simultaneous short circuit conditions present, the module power could dip below the operating condition.

PWM Output Short Circuit

When the output is switched on and there is an output short circuit condition present, the module behaves as follows:

1. Initiates the output to LOW.
2. Subsequently,
 - If *PWMxx.CycleCountEn* = 1 (Enabled):
 - a. The module waits for 5 seconds, then clears the short circuit fault status after wait and restarts PWM on detection of a rising edge on *O.Ptxx.Data*.
 - b. During wait, if *O.Ptxx.Data* or *C.PWMxx.CycleCountEn* changes to 0, stops wait immediately.
 - If *PWMxx.CycleCountEn* = 0 (Disabled):
 - a. Every 5 seconds, the module evaluates the short circuit condition by pulsing the output until the short circuit is resolved.
 - b. During the 5-second wait, if *O.Ptxx.Data* becomes zero, the module stops wait immediately and clears the short circuit fault status, then waits for a rising edge of *O.Ptxx.Data* to resume PWM output.
 - c. After 5 seconds, if the short circuit condition is no longer present, the module clears the fault status and continues to generate PWM output.
3. The point data that is produced remains LOW during the short circuit condition.

IMPORTANT For PWM output, a minimum pulse width of 20 ms is required for single instance short circuit detection.

Configure the Configurable Digital I/O Module

This chapter describes how to add and configure ArmorBlock 5000 16-channel configurable digital I/O modules to your system in a Studio 5000 Logix Designer application project.

Configure the Module IP Address

Before you can use your module in an EtherNet/IP network, you must configure its IP address, subnet mask, and optional Gateway address. The IP address identifies each node on the network or system of connected networks. Each node on a network (including your module) must have a unique IP address.

You can configure the module IP address in the following ways:

- Use the Network Configuration page on the secure web server.
- Use the network address switches on the module.
- Use the BOOTP/DHCP tool that ships with the Studio 5000 Logix Designer application.
- Retrieve the IP address from nonvolatile memory.

IMPORTANT

To use the BOOTP/DHCP tool, you must know the Ethernet hardware address (MAC ID) of your module.

Rockwell Automation assigns each module a unique 48-bit hardware address at the factory. The address is printed on a label on the side of your module. It consists of six groups of two hexadecimal digits that are separated by colons. The hardware sets the address and cannot be changed.

If you change or replace the module, you must enter the new Ethernet hardware address of the module when you configure the new module.

Set the Network Address Switches

The module reads the network address switches first to determine if the switches are set to a valid number. See [Table 14](#) for the available values. The module ships with the network address switches set to 999 and Dynamic Host Configuration Protocol (DHCP) enabled.

For instructions on how to adjust the network address switches, see the ArmorBlock 5000 16-channel Configurable Digital I/O Module Installation Instructions, publication [5032-IN002](#).

Figure 10 - Network Address Example

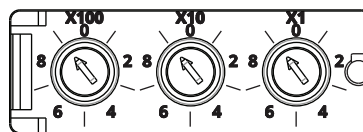

Network address switches set to default value of 999.

Table 14 - Values for Network Address Switches

Value	Description
000	Exits Protection Mode Cycles power to the module and restores the switches to their previous values For more information, see Protection Mode on page 26 .
001	Sets the module IP address to 192.168.1.1 This value is valid but not recommended as this IP address is typically used by network switches.
002...253 ⁽¹⁾	Sets the module IP address to 192.168.1.xxx (where xxx is the value of the network address switches) Subnet mask is set to 255.255.255.0 and the gateway address is set to 0.0.0.0. The module does not have a host name that is assigned to it or uses any Domain Name Server (DNS).

Table 14 - Values for Network Address Switches (Continued)

Value	Description
254	Sets the module IP address to 192.168.1.254 This value is valid but not recommended as this IP address is typically used by network switches.
888	Resets the module to factory default settings
900	Enters Protection Mode Cycles power to the module and restores the switches to their previous values For more information, see Protection Mode on page 26 .
999	The module checks to see if DHCP is enabled. <ul style="list-style-type: none"> If DHCP is enabled, the module requests for an IP address from a DHCP server. The DHCP server also assigns other network address parameters. If DHCP is not enabled, the module uses the IP address and other network address parameters that are stored in nonvolatile memory.

(1) If required, you can set other subnets and the gateway address using the custom IP feature.

Use the BOOTP/DHCP Tool

The BOOTP/DHCP tool is a standalone server that you can use to set an IP address. The BOOTP/DHCP tool sets an IP address and other TCP parameters.

You can use the BOOTP/DHCP tool to set the IP address when the device powers up in the out-of-box state. The out-of-box state assumes that the network address switches on the module are not set to a valid IP address (see [Table 14](#)), and the module is DHCP enabled.

For instructions on how to use the BOOTP/DHCP tool to set the IP address, see the EtherNet/IP Network Devices User Manual, publication [ENET-UM006](#).

Add the Module to a Studio 5000 Logix Designer Application Project

You must complete the following tasks before you can add the module:

- Create a Studio 5000 Logix Designer application project.
- Add a controller to the project.

For more information on how to add a controller to a Studio 5000 Logix Designer application project, see the User Manual for the controller.

After you create a Studio 5000 Logix Designer application project and add a controller to the project, you can use the following methods to add modules to the project.

- [Discover Modules](#)
- [New Module](#)

Discover Modules

To use the Discover Modules method, complete these steps.

1. Go online with your project.
The project must include a controller.
2. In the I/O Configuration tree, right-click the Ethernet network and select Discover Modules.

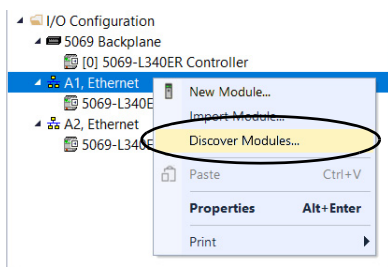

The Select Module Type dialog appears. The Module Discovery tab shows the available modules that are connected to the Ethernet network.

3. Select Create for the module that you want to add.

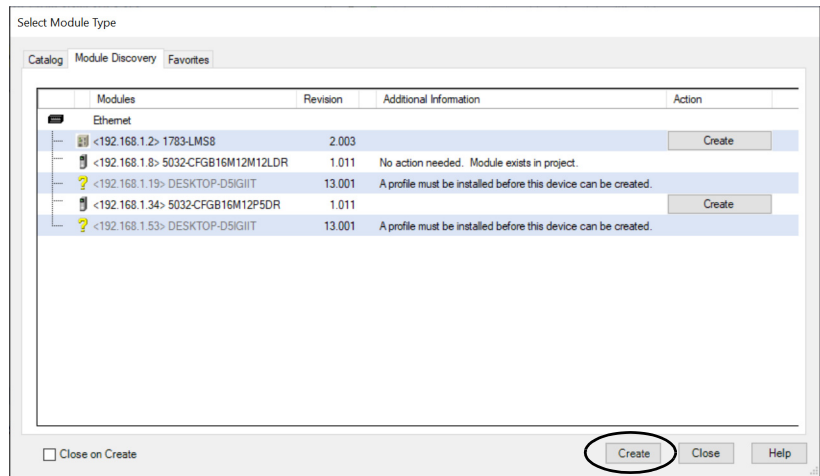

The New Module view appears and shows the Device Definition dialog. A list of different views is shown on the left side. The number and type of views that are shown depend on your Device Definition configuration.

4. On the Device Definition dialog, enter a name for the device, which is also used in the name of the Tag elements that get created for the module.

If you want to configure the other settings during this step, see [Edit the Module Properties on page 53](#) for more information.

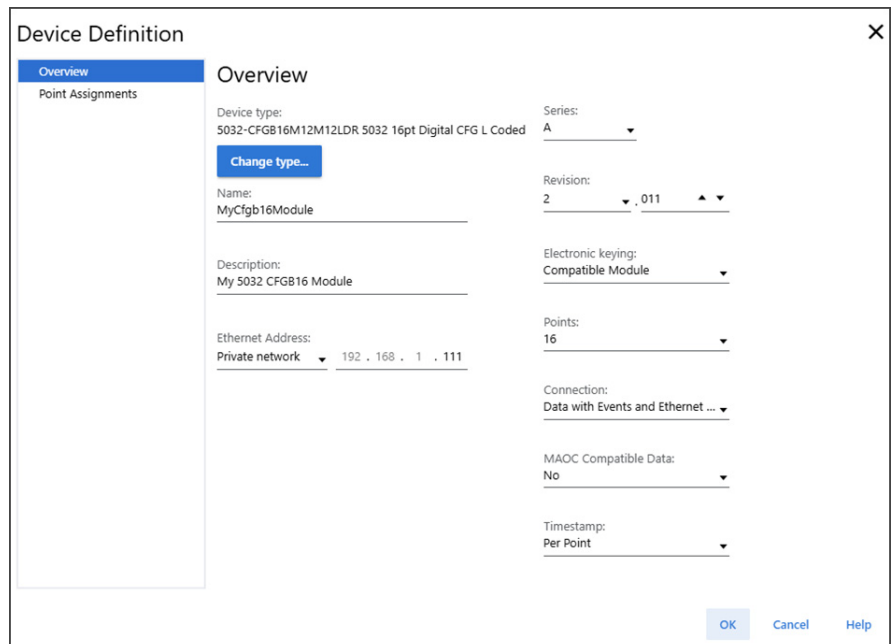

5. On the Device Definition dialog, select OK, and then on the New Module view, select OK to save the configuration.

A prompt appears to request to inhibit the module. We recommend inhibiting the module if the module is not fully configured or not ready to be put into operation currently.

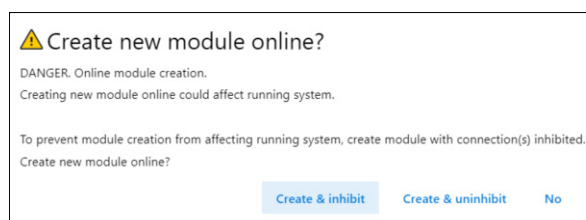

6. Repeat steps 3...5 to add another module, or close the Select Module Type dialog. If you selected the Close on Create checkbox in step 3, you must start from step 2 to add another module.

New Module



You can use the new module method when the project is offline or online.

To use the New Module method, complete these steps.

1. In the I/O Configuration tree, right-click the Ethernet network and select New Module.

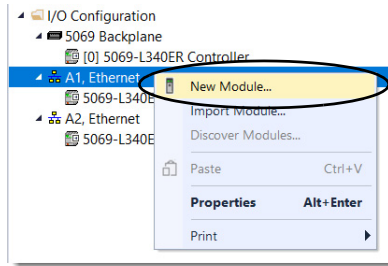

The Select Module Type dialog appears.

2. Select the module and select Create.

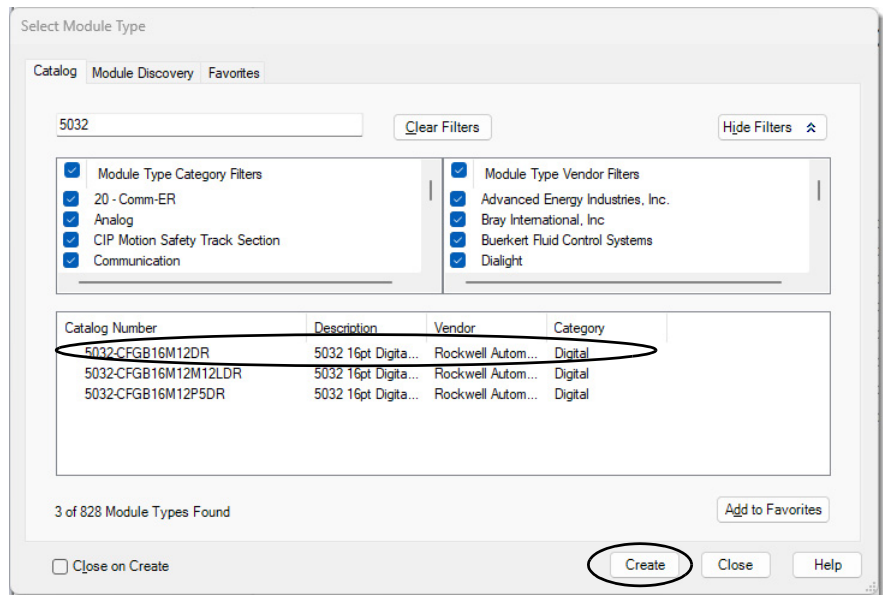

The New Module window appears and shows the Device Definition dialog. A list of different views is shown on the left side. The number and type of views that are shown depend on your Device Definition configuration.

3. Configure the following:
 - Enter a Name for the device.
 - Enter the Ethernet Address for the device.
 - Select the appropriate Connection type for your device.

If you want to configure the other settings during this step, see [Edit the Module Properties on page 53](#) for more information.

4. On the Device Definition dialog, select OK, and then on the New Module view, select OK to save the configuration.

A prompt appears to request to inhibit the module. We recommend inhibiting the module if the module is not fully configured or not ready to be put into operation currently.

5. Repeat steps 2...4 to add another module, or close the Select Module Type dialog. If you selected the Close on Create checkbox in step 2, you must start from step 1 to add another module.

Edit the Module Properties

Select the views in the New Module or Module Properties window to view and change the module configuration.

The following views for the module are described in this section.

- Information:
 - [Overview View](#)
 - [Connection View](#)
- Configuration:
 - [Device Information View](#)
 - [Points View](#)
 - [Input Events View](#)
 - [Internet Protocol View](#)
 - [Port Configuration View](#)
 - [Network View](#)
 - [Time Synchronization View](#)
 - [Servers View](#)

Overview View

The Overview view appears first when you create a module.

From this view, select Device Definition to complete the following tasks:

- Change the device type.
- Name the device.
- Describe the device.
- Configure the Ethernet Address.
- Access the Device Definition.

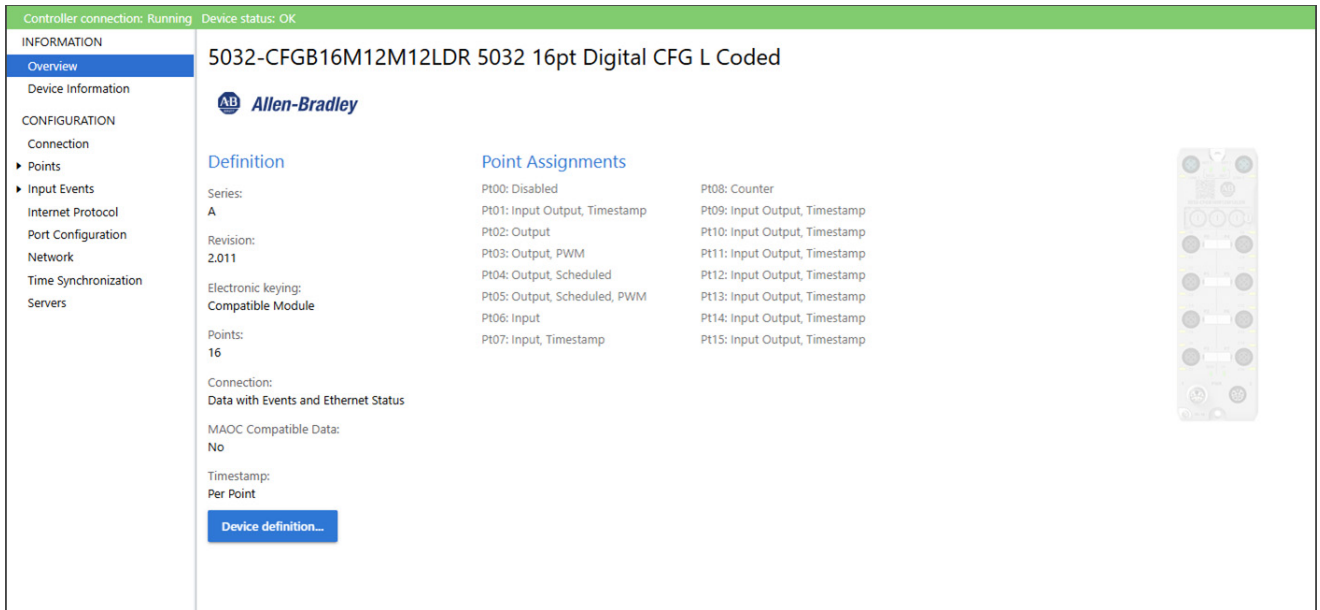

Device Definition - Overview

Access Device Definition from the Overview view.

Table 15 describes the parameters on the Device Definition Overview view.

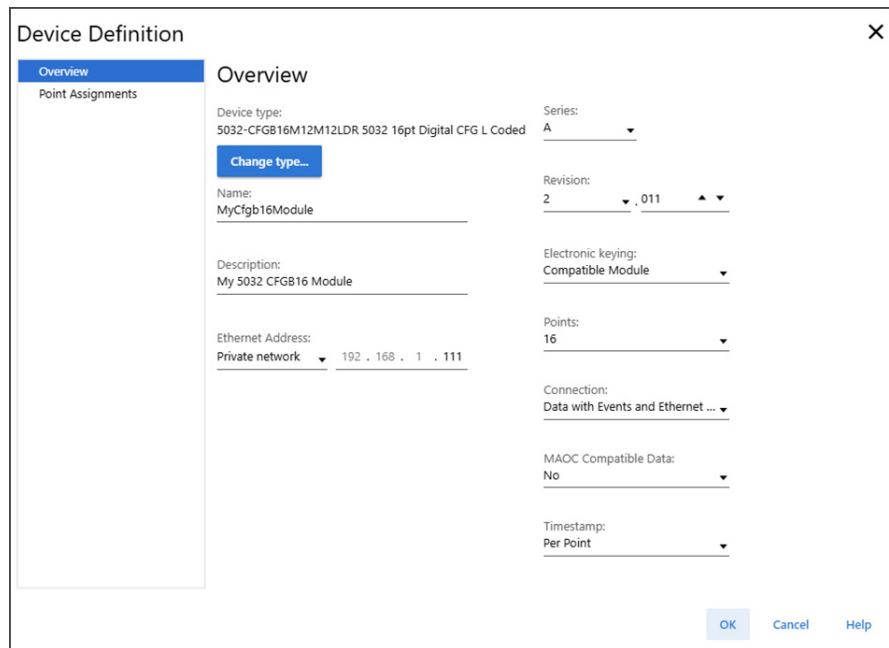

Table 15 - Configurable Digital I/O Device Definition Overview Parameters

Parameter	Definition	Available Choices
Device Type	Displays the device catalog number and type.	Device-specific
Name	Enter an IEC 61131 compliant device name If an invalid character is entered in this field, or if the name exceeds 40 characters, the software ignores the character.	All valid values
Description	Enter the description of the device.	All valid values
Ethernet Address	Select the type of Ethernet network and enter the Ethernet network address for the device.	All valid values
Series	Shows the module hardware series	Device-specific
Revision	Shows the module firmware revision, including major and minor revision levels	Device-specific
Electronic Keying	Software method by which you reduce the possibility of the wrong device in a control system For more information, see the following: <ul style="list-style-type: none"> Configurable Digital I/O Module Device Definitions on page 89 Electronic Keying in Logix 5000 Control Systems Application Technique, publication LOGIX-AT001 	<ul style="list-style-type: none"> Exact Match Compatible Module Disable Keying
Points	Shows the number of points to be configured	<ul style="list-style-type: none"> 8 16
Connection	Determines the following for the module type that you configure: <ul style="list-style-type: none"> Available configuration parameters Type of data that is transferred between the module and the controller Which tags are generated when configuration is complete 	<ul style="list-style-type: none"> Data Listen Only Data Data and Ethernet Status Data with Events Listen Only Data with Events Data with Events and Ethernet Status Scheduled Output⁽¹⁾ Scheduled Output and Status⁽¹⁾
MAOC Compatible Data	Specifies whether the data is compatible with Motion Arm Output Cam (MAOC) instruction. If the data is not compatible with MAOC, you cannot use this module with MAOC instruction.	<ul style="list-style-type: none"> No Yes
Timestamp	Shows the timestamp format	When MAOC Compatible Data is configured as No: <ul style="list-style-type: none"> Per Point FIFO When MAOC Compatible Data is configured as Yes: <ul style="list-style-type: none"> None

(1) This connection type is not available with firmware revision 2.011 or later.



In online mode, only the Name, Description, and Electronic Keying parameters can be changed.

Available Connection Types

The Connection choice determines what data is exchanged between the owner-controller and the module.

[Table 16](#) describes the connection types that you can use with the ArmorBlock 5000 16-channel configurable digital I/O module.

Table 16 - Connection Types for Configurable Digital I/O Module

Connection Type	Description
Data	The module returns the following to the controller: <ul style="list-style-type: none"> General fault data Input data Counter data The controller returns the following to the module: <ul style="list-style-type: none"> Output data 16 Scheduled data (if MAOC Compatible Data is No)⁽¹⁾ 32 Scheduled data (if MAOC Compatible Data is Yes)⁽²⁾

Table 16 - Connection Types for Configurable Digital I/O Module (Continued)

Connection Type	Description
Listen Only Data	<p>The module returns the following to the controller:</p> <ul style="list-style-type: none"> • General fault data • Input data • Counter data • 16 Scheduled data (if MAOC Compatible Data is No)⁽¹⁾ • 32 Scheduled data (if MAOC Compatible Data is Yes)⁽²⁾
Data and Ethernet Status	<p>The module returns the following to the controller:</p> <ul style="list-style-type: none"> • General fault data • Input data • Counter data • Ethernet Status data <p>The controller returns the following to the module:</p> <ul style="list-style-type: none"> • Output data • 16 Scheduled data (if MAOC Compatible Data is No)⁽¹⁾ • 32 Scheduled data (if MAOC Compatible Data is Yes)⁽²⁾
Data with Events	<p>The module returns the following to the controller:</p> <ul style="list-style-type: none"> • General fault data • Input data • Counter data • Event input data <p>The controller returns the following to the module:</p> <ul style="list-style-type: none"> • Output data • Event output data • 16 Scheduled data (if MAOC Compatible Data is No)⁽¹⁾ • 32 Scheduled data (if MAOC Compatible Data is Yes)⁽²⁾
Listen Only Data with Events	<p>The module returns the following to the controller:</p> <ul style="list-style-type: none"> • General fault data • Input data • Counter data • Event input data • 16 Scheduled data (if MAOC Compatible Data is No)⁽¹⁾ • 32 Scheduled data (if MAOC Compatible Data is Yes)⁽²⁾
Data with Events and Ethernet Status	<p>The module returns the following to the controller:</p> <ul style="list-style-type: none"> • General fault data • Input data • Counter data • Ethernet Status data • Event input data <p>The controller returns the following to the module:</p> <ul style="list-style-type: none"> • Output data • Event output data • 16 Scheduled data (if MAOC Compatible Data is No)⁽¹⁾ • 32 Scheduled data (if MAOC Compatible Data is Yes)⁽²⁾
Scheduled Output ⁽³⁾⁽⁴⁾	<p>The module returns the following to the controller:</p> <ul style="list-style-type: none"> • General fault data <p>The controller returns the following to the module:</p> <ul style="list-style-type: none"> • 32 Scheduled data
Scheduled Output and Status ⁽³⁾⁽⁴⁾	<p>The module returns the following to the controller:</p> <ul style="list-style-type: none"> • General fault data • Ethernet Status data <p>The controller returns the following to the module:</p> <ul style="list-style-type: none"> • 32 Scheduled data

(1) This data is only applicable for firmware revision 2.011 or later and at least one output is configured as "Output, Scheduled" or "Output, Scheduled, PWM".
 (2) This data is only applicable for firmware revision 2.011 or later.
 (3) When connection type is "Scheduled Output" or "Scheduled Output with Status" all points are configured as "Digital Output, Short Circuit".
 (4) This connection type is not available with firmware revision 2.011 or later.

For more information on how to use the Device Definition parameters for ArmorBlock 5000 16-channel configurable digital I/O modules, see the Studio 5000 Logix Designer application online Help.

Device Definition – Point Assignments

Access Device Definition from the Overview view.

Table 17 describes the parameters on the Device Definition Point Assignments view.

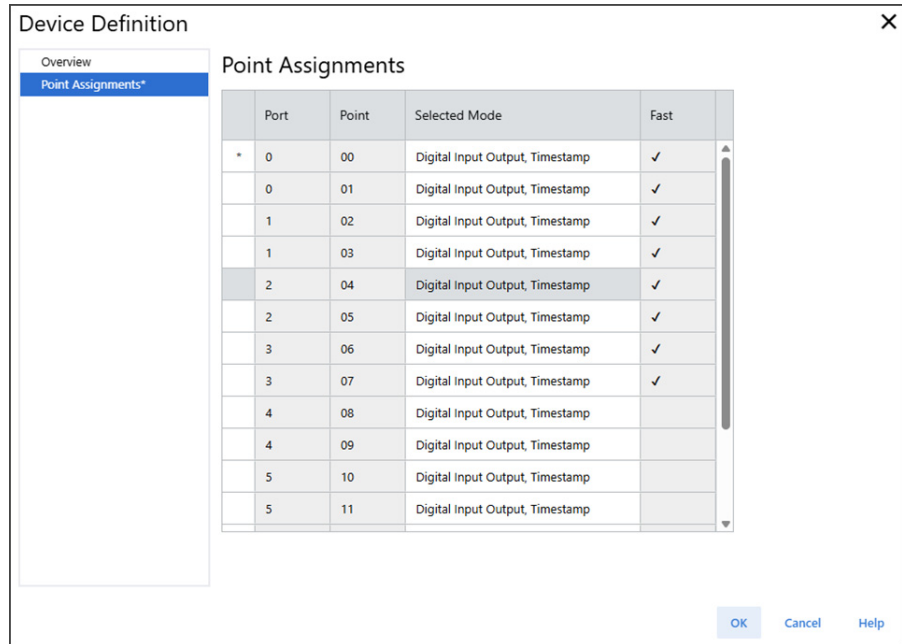

Table 17 - Configurable Digital I/O Device Definition Point Assignments Parameters

Parameter	Definition	Available Choices
Port	Shows the module port numbers	Not configurable
Point	Shows the module point numbers	Not configurable
Selected Mode	Shows the mode for the point	When MAOC Compatible Data is configured as No: <ul style="list-style-type: none"> • Disabled • Input Output, Timestamp⁽¹⁾⁽²⁾ • Input Output⁽²⁾⁽³⁾⁽⁴⁾ • Output • Output, PWM⁽²⁾⁽⁵⁾ • Output, Scheduled⁽²⁾ • Output, Scheduled, PWM⁽²⁾⁽⁵⁾ • Input • Input, Timestamp⁽¹⁾ • Input, FIFO⁽³⁾⁽⁴⁾ • Counter When MAOC Compatible Data is configured as Yes: <ul style="list-style-type: none"> • Disabled • Output, Scheduled⁽²⁾ • Input
Fast	Shows whether channel is Fast or Standard	Not configurable

(1) This mode is available only when you select the Timestamp format as Per Point.
 (2) This mode is available only with firmware revision 2.011 or later.
 (3) This mode is available only when you select Timestamp format as FIFO.
 (4) This mode is not available for connection types "Data with Events" and "Data with Events and Ethernet Status".
 (5) This mode is available only for Fast I/O ports.

Connection View

Use the Connection view to complete the following tasks:

- Set the RPI rate. The valid RPI values are 0.2...750 ms.
For more information on RPI, see [Requested Packet Interval on page 14](#).
- Set the Input Data Event RPI rate when you select an event connection type. The valid RPI values are 0.2...750 ms.
- Set the connection type to use on the EtherNet/IP network.
For more information on unicast and multicast connections, see the Ethernet Reference Manual, publication [ENET-RM002](#).
- Inhibit or uninhibit the module.
For more information on how to inhibit the module, see [Module Inhibiting on page 18](#).
- Configure whether a connection failure while the controller is in Run mode causes a major or minor fault.

Connection Type	Requested Packet Interval (RPI)			Connection over EtherNet/IP
	Value	Unit	Range	
Data	750.0	ms	0.2 - 750.0	Unicast
InputDataEvent	5.0	ms	0.2 - 750.0	Unicast
Status	200.0	ms	25.0 - 750.0	Unicast



The Connection fault area of the Connection view is useful for troubleshooting. For more information on the Module Fault area, see [Device Fault Descriptions on Connection View on page 84](#).

Unicast Connection Over EtherNet/IP

When you configure a module, you must configure the Connection over EtherNet/IP parameter. The configuration choice dictates how input data is transmitted over the network.

The module uses one of the following methods to transmit data:

- Multicast - Multicast connections deliver information from one sender to multiple receivers simultaneously.
Copies of one transmission are passed to a selected subset of possible destinations.
- Unicast - Unicast connections are point-to-point transmissions between a source node and destination node on the network.
A transmission is sent to one destination controller depending on the module configuration.

Unicast is the default setting. We recommend that you use Unicast because it reduces network bandwidth usage. However, if you are using a ControlLogix 5580 redundant controller, you must use Multicast.

Multicast is more efficient than sending multiple Unicast streams to multiple nodes. If you are using the ArmorBlock 5000 16-channel configurable digital I/O module in a redundancy application, use Multicast.

Device Information View

The Device Information view shows the module and status information when the project is online and lets you reset the module.

Use the Device Information view to complete the following tasks:

- Determine the identity of the module.
- Access module diagnostics.
- Refresh the data on the screen.
- Reset the module.

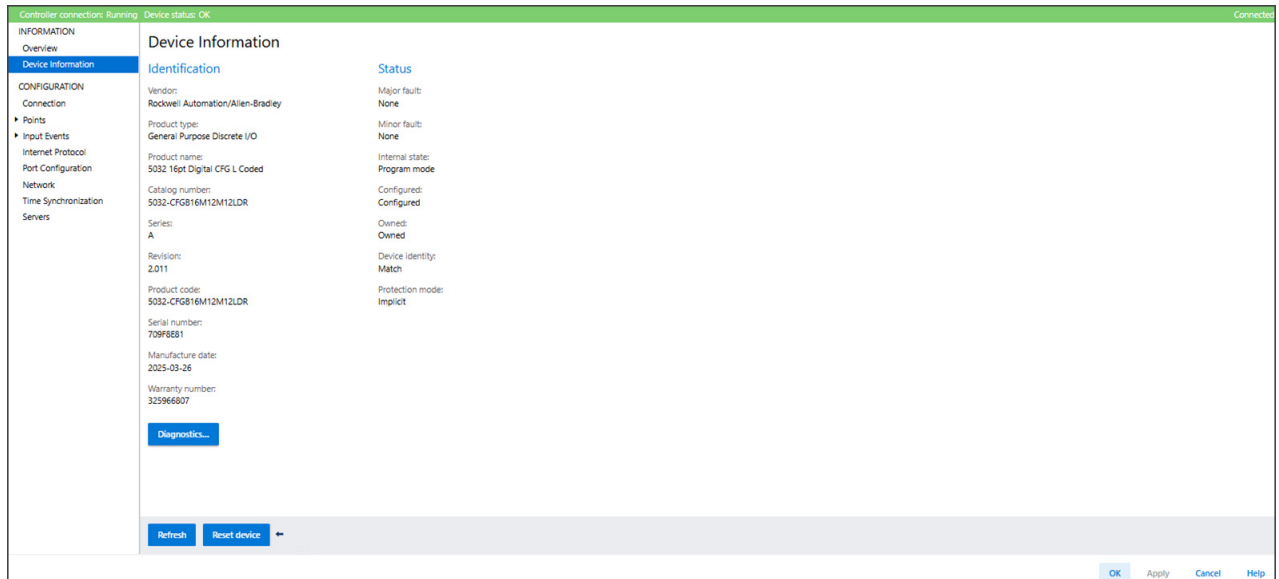

Points View

The Points view shows an overview of the configuration values for all module points. The values for each parameter indicate how that particular point is configured on that specific point view.

IMPORTANT You can edit the fields on the Points view. However, we recommend that you change the point configuration on the specific point view as described in the rest of this section.
Use this view to monitor the configuration for all module points.



Ptxx Views

The Ptxx views, where xx represents the point number, shows the configuration options available for that point.

The following point modes are available:

- [Ptxx - Counter](#)
- [Ptxx - Input](#)
- [Ptxx - Input, Timestamp](#)
- [Ptxx - Input, FIFO](#)
- [Ptxx - Output](#)
- [Ptxx - Output, Scheduled](#)
- [Ptxx - Output, PWM](#)
- [Ptxx - Output, Scheduled, PWM](#)
- [Ptxx - Input Output](#)
 - [Ptxx - Input Output - Input](#)
 - [Ptxx - Input Output - Output](#)
- [Ptxx - Input Output, Timestamp](#)
 - [Ptxx - Input Output, Timestamp - Input](#)
 - [Ptxx - Input Output, Timestamp - Output](#)

The point modes are configured in the Point Assignments view, see [Device Definition – Point Assignments on page 57](#). Not all point modes can be configured for each point.

Pt_{xx} - Counter

This view is available when the point is configured as “Counter”. You can perform certain tasks only when the project is online.

Use this view to complete the following tasks:

- Select the Input Filter Time.
- Enable or disable Counter Rollover at Preset.
- Access the point diagnostics.

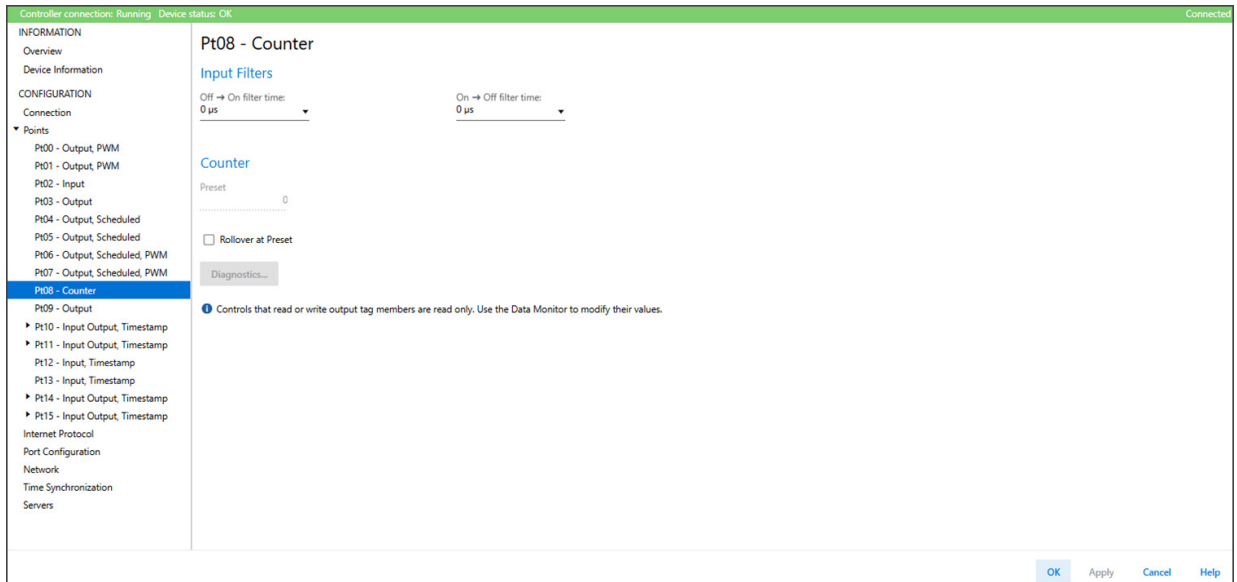

Pt_{xx} - Input

This view is available when the point is configured as “Input”. You can perform certain tasks only when the project is online.

Use this view to complete the following tasks:

- Select the Input Filter Time.
- Access the point diagnostics.

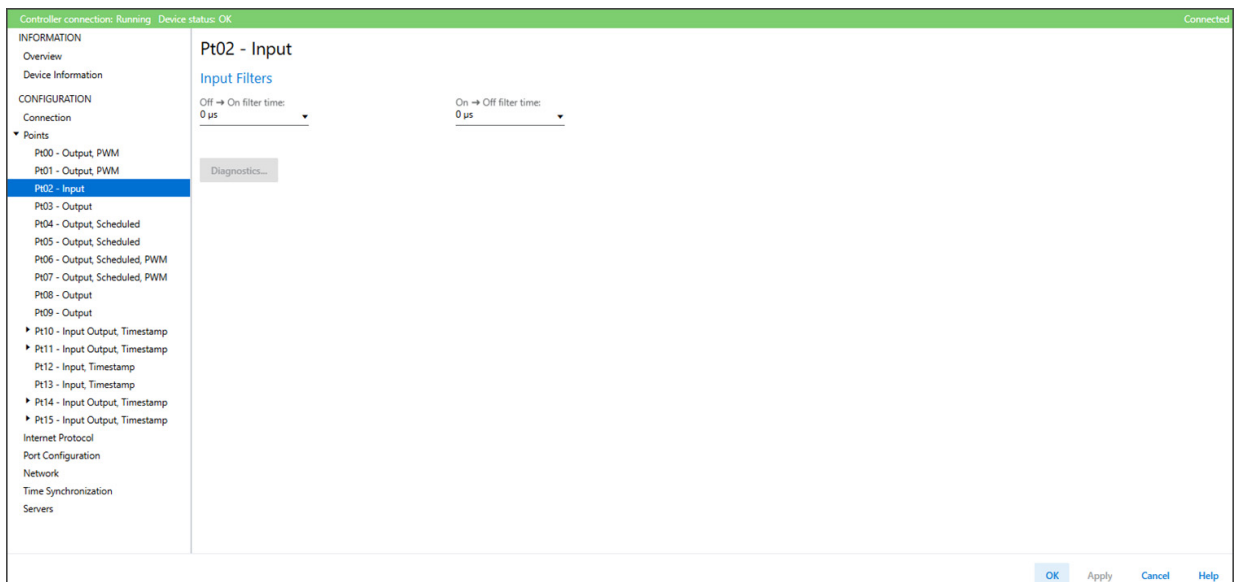

Pt_x - Input, Timestamp

This view is available when the point is configured as “Input, Timestamp”. You can perform certain tasks only when the project is online.

Use this view to complete the following tasks:

- Select the Input Filter Time.
- Capture timestamps for Input transitions.
- Enable or disable Timestamp Latching.
- Enable or disable Chatter Detection.
- Configure the Chatter Detection options.
- Access the point diagnostics.

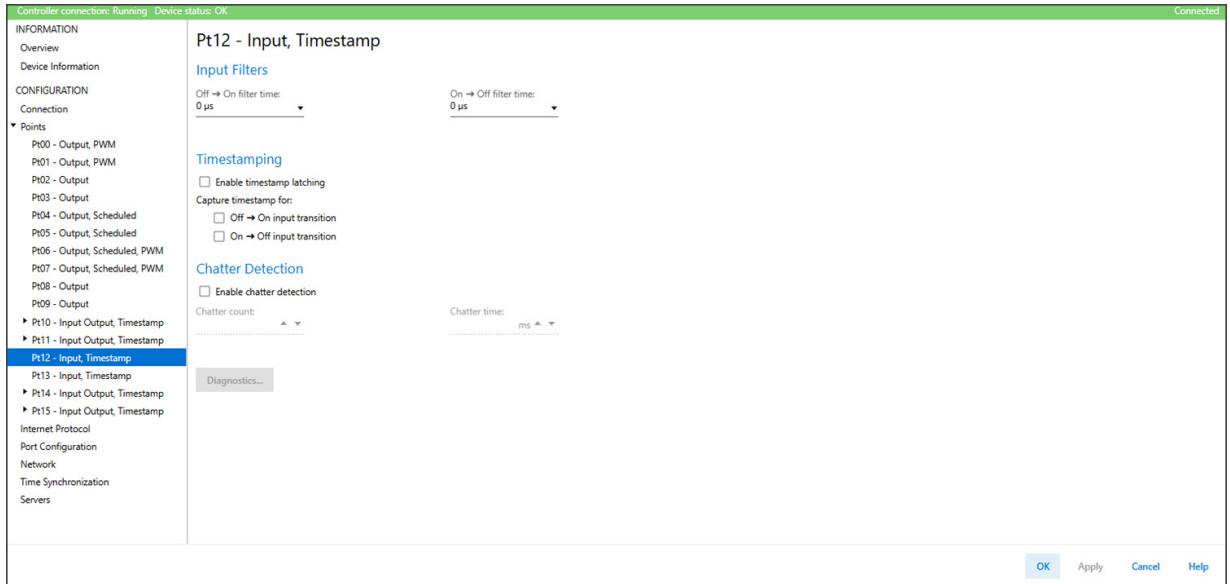

Pttx - Input, FIFO

This view is available when the point is configured as “Input, FIFO”. You can perform certain tasks only when the point is online.

Use this view to complete the following tasks:

- Select the Input Filter Time.
- Capture timestamps for Input transitions.
- Enable or disable Chatter Detection.
- Configure the Chatter Detection options.
- Access the point diagnostics.

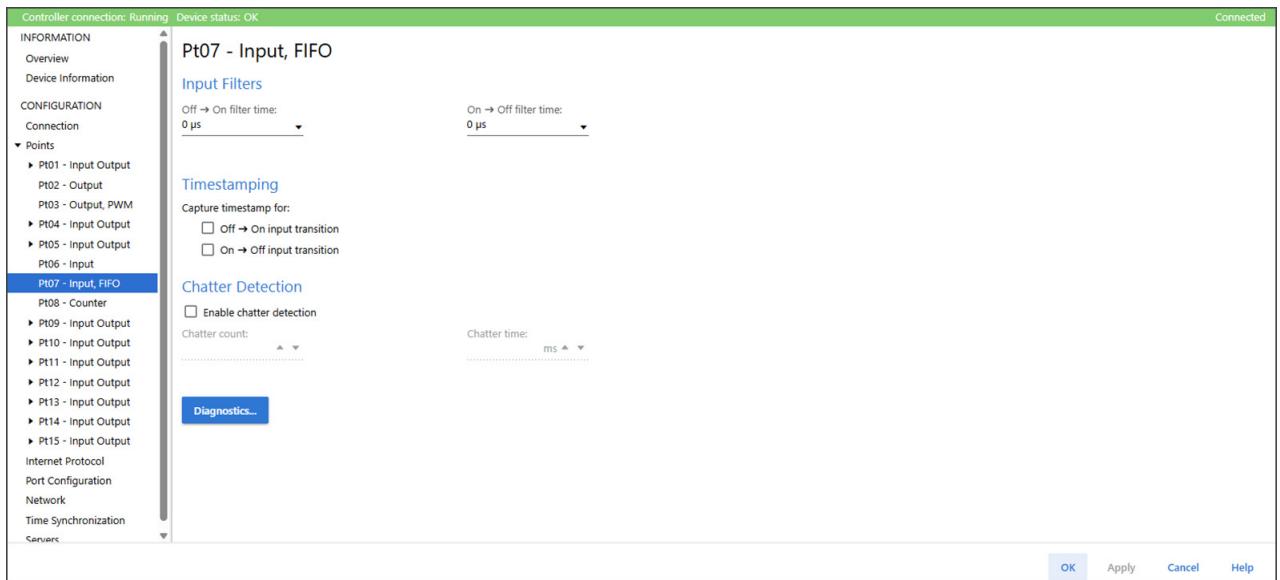

Pttx - Output

This view is available when the point is configured as "Output". You can perform certain tasks only when the project is online.

Use this view to complete the following tasks:

- Select the Program Mode and Communication Fault Mode Output states.
- Configure the output state when communication fails in Program Mode.
- Access the point diagnostics.

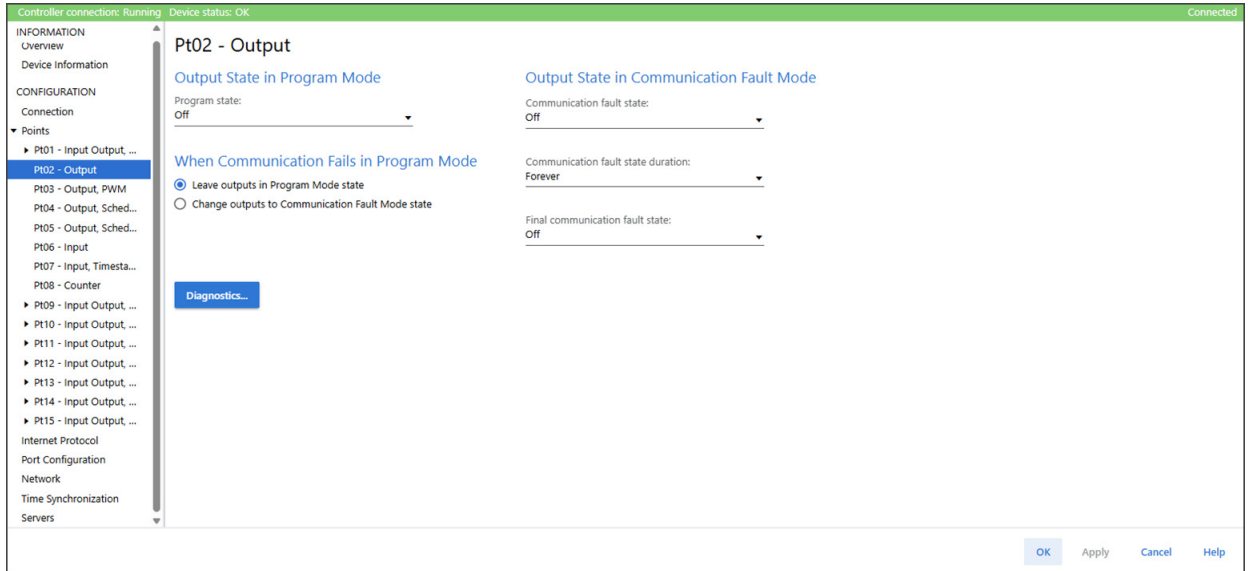

Pttx - Output, Scheduled

This view is available when the point is configured as "Output, Scheduled". You can perform certain tasks only when the project is online.

Use this view to complete the following tasks:

- Select the Program Mode and Communication Fault Mode Output states.
- Configure the output state when communication fails in Program Mode.
- Access the point diagnostics.

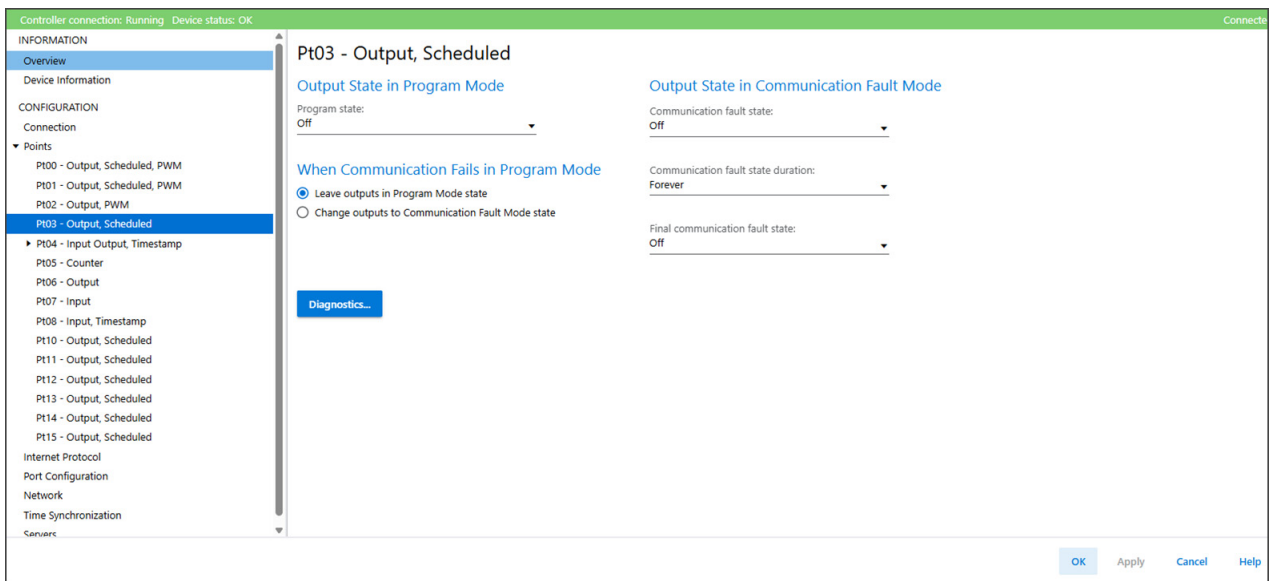

Pttx - Output, PWM

This view is available when the point is configured as “Output, PWM”. You can perform certain tasks only when the project is online.

Use this view to complete the following tasks:

- Enable or disable PWM
- Enforce the duty cycle for PTO
- Enable or disable the cycle count limit
- Select the Program Mode and Communication Fault Mode Output states.
- Configure the output state when communication fails in Program Mode.
- Access the point diagnostics.

The screenshot displays the configuration window for Pt02 - Output, PWM. The interface includes a left-hand navigation pane with categories like INFORMATION, CONFIGURATION, and Points. The main area is titled 'Pt02 - Output, PWM' and contains the following settings:

- Enable Pulse Width Modulation (PWM)
- Enforce Duty Cycle at 50.0 % for Pulse Train Output (PTO)
 - Cycle Time: 0.00 seconds
- Enable Cycle Count Limit:
 - Execute All Cycles
 - Duty Cycle: 0.00 %
- Output State in Program Mode**
 - Program state: Off
- Output State in Communication Fault Mode**
 - Communication fault state: Off
 - Communication fault state duration: Forever
 - Final communication fault state: Off
- When Communication Fails in Program Mode**
 - Leave outputs in Program Mode state
 - Change outputs to Communication Fault Mode state

At the bottom of the main area, there is a 'Diagnostics...' button and a note: 'Controls that read or write output tag members are read only. Use the Data Monitor to modify their values.' The bottom right corner of the window features 'OK', 'Apply', 'Cancel', and 'Help' buttons.

Pttx - Output, Scheduled, PWM

This view is available when the point is configured as “Output, Scheduled, PWM”. You can perform certain tasks only when the project is online.

Use this view to complete the following tasks:

- Enable or disable PWM
- Enforce the duty cycle for PTO
- Enable or disable the cycle count limit
- Select the Program Mode and Communication Fault Mode Output states.
- Configure the output state when communication fails in Program Mode.
- Access the point diagnostics.

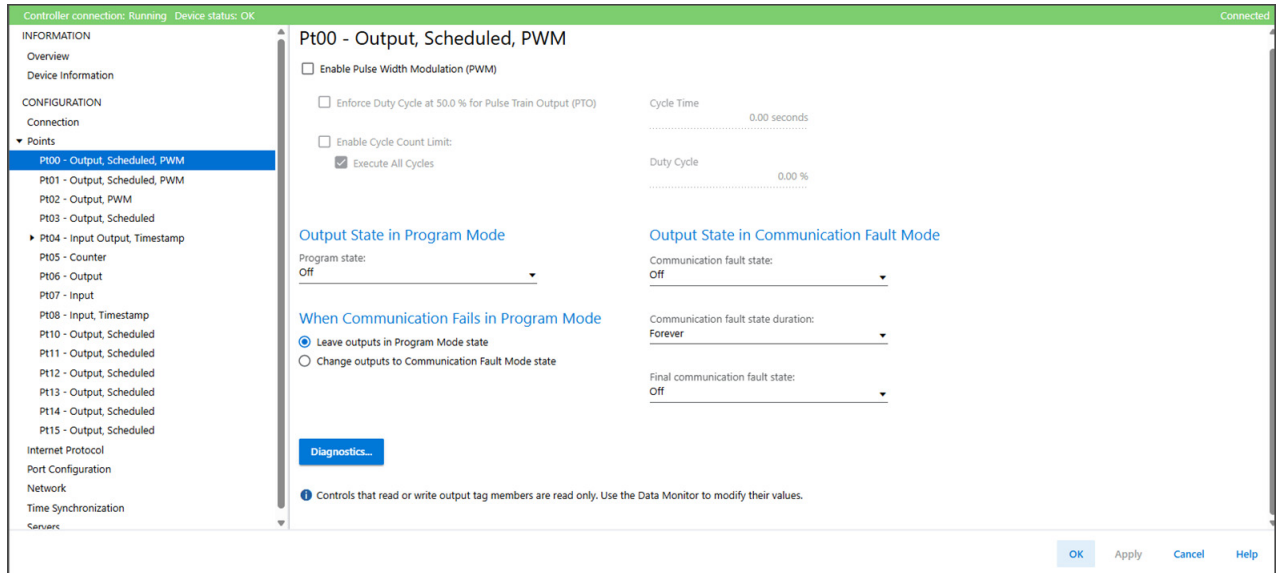

Pttx - Input Output

This view is available when the point is configured as “Input Output”. You can perform certain tasks only when the project is online.

Use this view to access the point diagnostics.

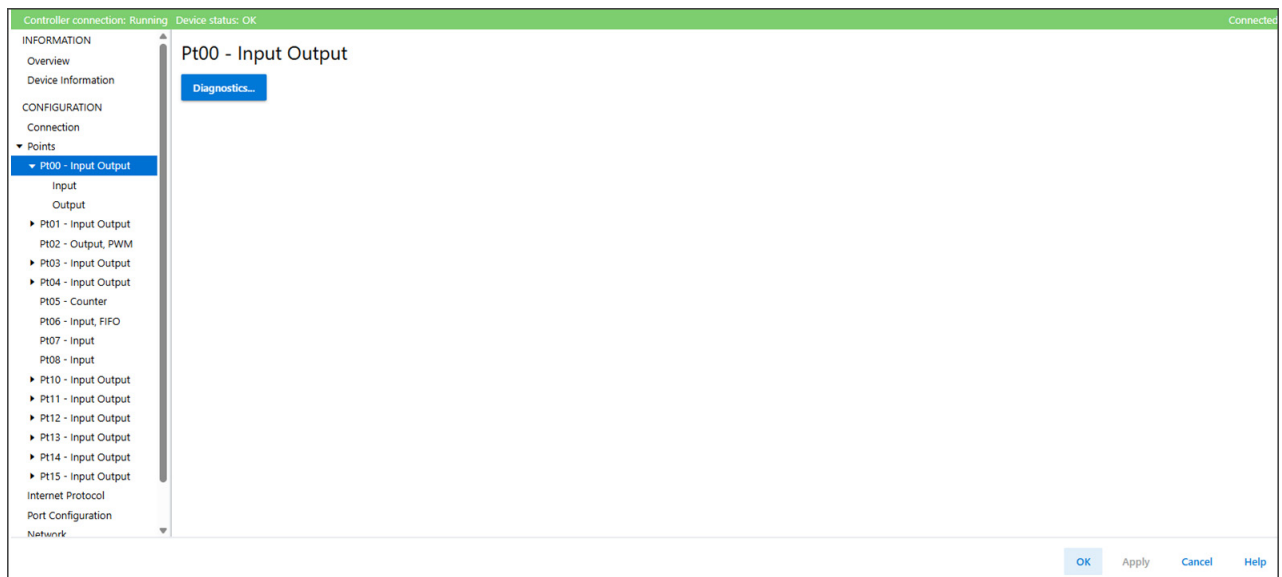

Pt00 - Input Output - Input

This sub view is available when the point is configured as “Input Output”. You can perform certain tasks only when the project is online.

Use this view to select the Input Filter Time.

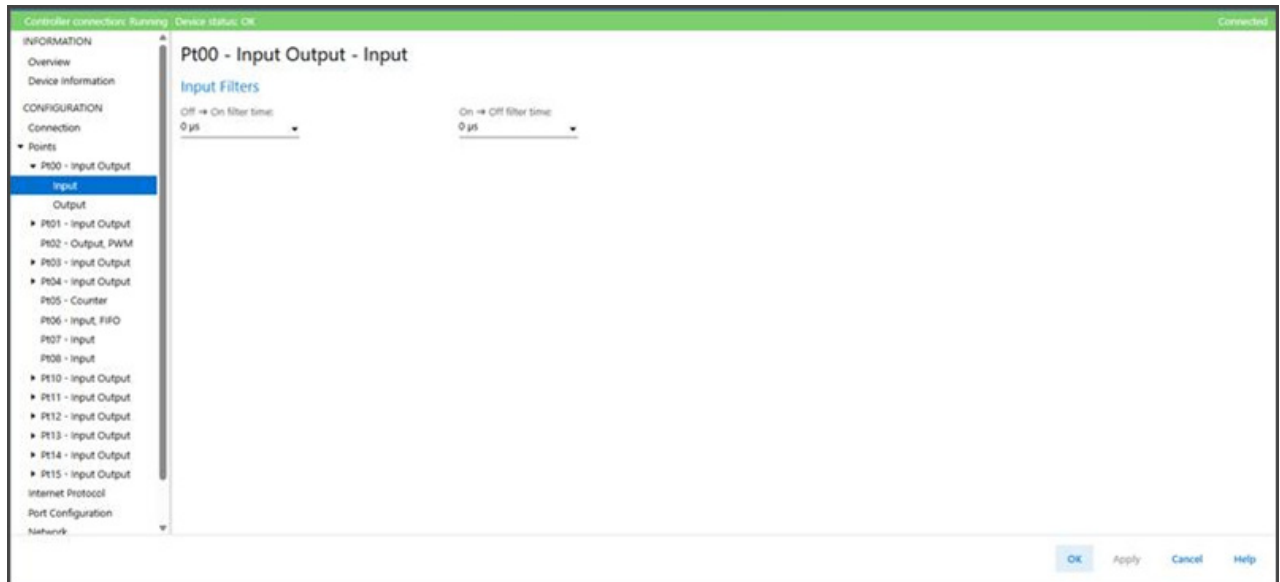

Pt00 - Input Output - Output

This sub view is available when the point is configured as “Input Output”. You can perform certain tasks only when the project is online.

Use this view to complete the following tasks:

- Select the Program Mode and Communication Fault Mode Output states.
- Configure the output state when communication fails in Program Mode.

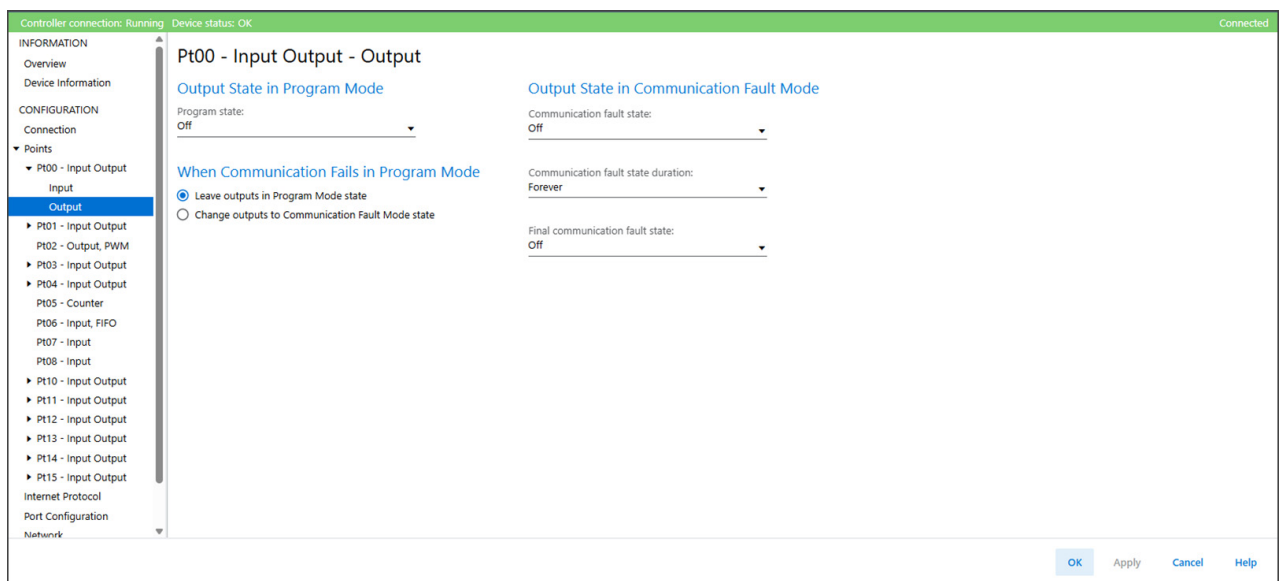

Pttx - Input Output, Timestamp

This view is available when the point is configured as “Input Output, Timestamp”. You can perform certain tasks only when the project is online.

Use this view to access the point diagnostics.

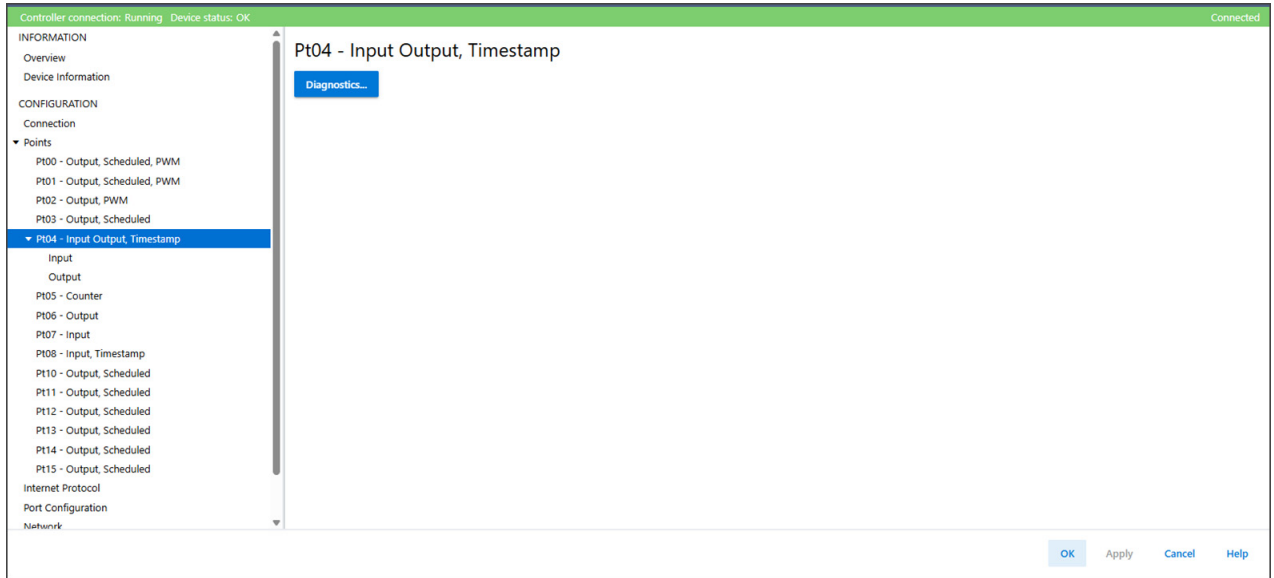

Pttx - Input Output, Timestamp - Input

This sub view is available when the point is configured as “Input Output, Timestamp”. You can perform certain tasks only when the project is online.

Use this view to complete the following tasks:

- Select the Input Filter Time.
- Capture timestamps for Input transitions.
- Enable or disable Timestamp Latching.
- Enable or disable Chatter Detection.
- Configure the Chatter Detection options.

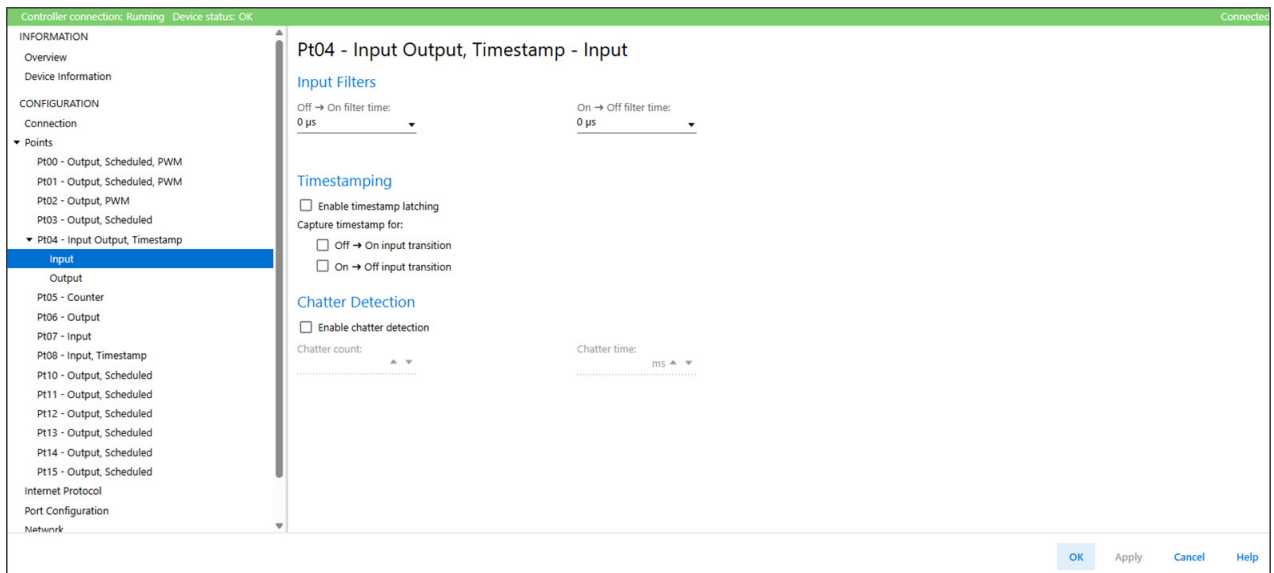

Pttx - Input Output, Timestamp - Output

This sub view is available when the point is configured as “Input Output, Timestamp”. You can perform certain tasks only when the project is online.

Use this view to complete the following tasks:

- Select the Program Mode and Communication Fault Mode Output states.
- Configure the output state when communication fails in Program Mode.

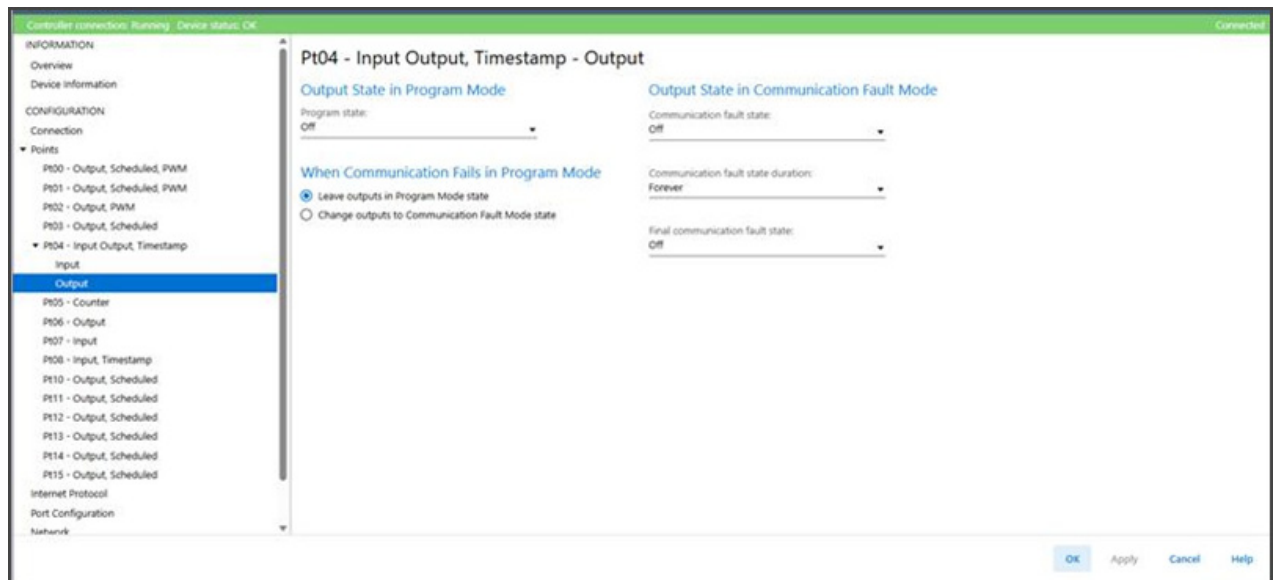

Input Events View

The Input Events view shows an overview of the configuration values for all input events. You can perform certain tasks only when the project is online.

This view is only available when you select the “Data with Events” or “Data with Events and Ethernet Status” connection type in the Device Definition. See [Device Definition - Overview on page 54](#).

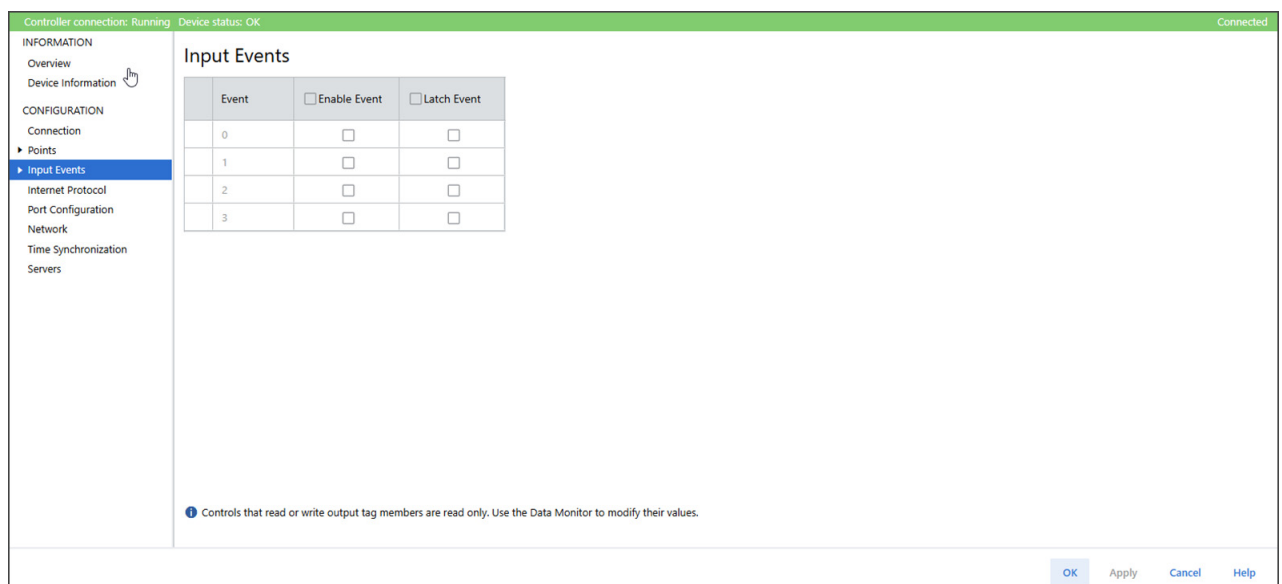

IMPORTANT You cannot configure events on the Input Events view. The parameters that are displayed in this view are read-only. You must use the Event Output tags to configure an event. For more information, see [Event Output Tags on page 98](#).

Input Eventxx View

The Input Eventxx view, where xx represents the index of an event definition, shows the configuration options available for that event. You cannot configure the parameters from this view, you must use the configuration tags.

Use this view to review the following tasks:

- Whether the Input event is enabled
- Whether the Input event is latched
- Whether Independent Point Triggers for the Input event is enabled
- Check the Trigger condition for the Input event.
- Check the participants and their State Transition behavior for the Input event

Input Event00

Enable event

Latch event

Enable independent point triggers

Trigger event
Disable

Event Trigger Pattern

	<input type="checkbox"/> Participate in Event Trigger	State Transition
Pt02	<input type="checkbox"/>	Off
Pt03	<input type="checkbox"/>	Off
Counter04 Done	<input type="checkbox"/>	Off
Pt05	<input type="checkbox"/>	Off
Pt06	<input type="checkbox"/>	Off
Pt07	<input type="checkbox"/>	Off
Pt08	<input type="checkbox"/>	Off
Pt09	<input type="checkbox"/>	Off
Pt10	<input type="checkbox"/>	Off
Pt11	<input type="checkbox"/>	Off
Pt12	<input type="checkbox"/>	Off
Pt13	<input type="checkbox"/>	Off
Pt14	<input type="checkbox"/>	Off
Pt15	<input type="checkbox"/>	Off

Controls that read or write output tag members are read only. Use the Data Monitor to modify their values.

Event Definition

Table 18 describes the event definition parameters that you can configure using the Event Output tags.

Name	Value	Force Mask	Style
My16cfgModule:EO	-	-	-
My16cfgModule:EO.Event00	-	-	-
My16cfgModule:EO.Event00.En	0		Decimal
My16cfgModule:EO.Event00.EventRisingEn	0		Decimal
My16cfgModule:EO.Event00.EventFallingEn	0		Decimal
My16cfgModule:EO.Event00.LatchEn	0		Decimal
My16cfgModule:EO.Event00.ResetEvent	0		Decimal
My16cfgModule:EO.Event00.IndependentConditionTriggerEn	0		Decimal
My16cfgModule:EO.Event00.EventNumberAck	0		Decimal
My16cfgModule:EO.Event00.Pt02DataSelect	0		Decimal
My16cfgModule:EO.Event00.Pt03DataSelect	0		Decimal
My16cfgModule:EO.Event00.Counter04Select	0		Decimal
My16cfgModule:EO.Event00.Pt05DataSelect	0		Decimal
My16cfgModule:EO.Event00.Pt06DataSelect	0		Decimal
My16cfgModule:EO.Event00.Pt07DataSelect	0		Decimal
My16cfgModule:EO.Event00.Pt08DataSelect	0		Decimal
My16cfgModule:EO.Event00.Pt09DataSelect	0		Decimal
My16cfgModule:EO.Event00.Pt10DataSelect	0		Decimal
My16cfgModule:EO.Event00.Pt11DataSelect	0		Decimal
My16cfgModule:EO.Event00.Pt12DataSelect	0		Decimal
My16cfgModule:EO.Event00.Pt13DataSelect	0		Decimal
My16cfgModule:EO.Event00.Pt14DataSelect	0		Decimal
My16cfgModule:EO.Event00.Pt15DataSelect	0		Decimal
My16cfgModule:EO.Event00.Pt02DataValue	0		Decimal
My16cfgModule:EO.Event00.Pt03DataValue	0		Decimal
My16cfgModule:EO.Event00.Counter04Value	0		Decimal
My16cfgModule:EO.Event00.Pt05DataValue	0		Decimal
My16cfgModule:EO.Event00.Pt06DataValue	0		Decimal
My16cfgModule:EO.Event00.Pt07DataValue	0		Decimal
My16cfgModule:EO.Event00.Pt08DataValue	0		Decimal
My16cfgModule:EO.Event00.Pt09DataValue	0		Decimal
My16cfgModule:EO.Event00.Pt10DataValue	0		Decimal
My16cfgModule:EO.Event00.Pt11DataValue	0		Decimal
My16cfgModule:EO.Event00.Pt12DataValue	0		Decimal
My16cfgModule:EO.Event00.Pt13DataValue	0		Decimal
My16cfgModule:EO.Event00.Pt14DataValue	0		Decimal
My16cfgModule:EO.Event00.Pt15DataValue	0		Decimal

Table 18 - Event Definition Tags

Task	Event Output Tag to Change	Valid Values
Enable the event.	<i>EO.Eventxx.En</i>	0 = Event is disabled 1 = Event is enabled
Determine if an input state change on any single selected point or a pattern of input state changes across all selected points triggers the event.	<i>EO.Eventxx.IndependentConditionTriggerEn</i>	0 = Pattern of input state changes triggers the event 1 = Single input state change triggers the event
Select at least one point on the module to participate in the event.	The tag name changes based on the input function. The following names are available: <ul style="list-style-type: none"> <i>EO.Eventxx.PtxxDataSelect</i> - This tag appears for any point that is configured as "Digital Input" or "Digital Input, Timestamp". <i>EO.Eventxx.CounterxxSelect</i> - This tag appears for any point that is configured as "Digital Input, Counter". 	0 = Point does not participate in the event trigger 1 = Point participates in the event trigger

Table 18 - Event Definition Tags (Continued)

Task	Event Output Tag to Change	Valid Values
For all points that participate in the event, determine what constitutes an event state.	<p>The tag name changes based on the input function. The following names are available:</p> <ul style="list-style-type: none"> <i>EO.Eventxx.PtxxDataValue</i> - This tag appears for any point that is configured as "Digital Input" or "Digital Input, Timestamp". <i>EO.Eventxx.CounterxxValue</i> - This tag appears for any point that is configured as "Digital Input, Counter". 	<p>0 = On to Off state transition 1 = Off to On state transition</p>
Determine which edge of the event triggers the event. That is, the rising edge, falling edge, or either edge of the event.	<p>Both of the following:</p> <ul style="list-style-type: none"> <i>EO.Eventxx.EventRisingEn</i> <i>EO.Eventxx.EventFallingEn</i> 	<p>The combination of the tag settings determines which edge triggers the event:</p> <ul style="list-style-type: none"> This combination triggers the event on a rising edge: <ul style="list-style-type: none"> <i>EO.Eventxx.EventRisingEn</i> = 1 <i>EO.Eventxx.EventFallingEn</i> = 0 This combination triggers the event on a falling edge: <ul style="list-style-type: none"> <i>EO.Eventxx.EventRisingEn</i> = 0 <i>EO.Eventxx.EventFallingEn</i> = 1 This combination triggers the event on either a rising or falling edge: <ul style="list-style-type: none"> <i>EO.Eventxx.EventRisingEn</i> = 1 <i>EO.Eventxx.EventFallingEn</i> = 1
Determines whether to latch the event.	<i>EO.Eventxx.LatchEn</i>	<p>0 = Event is not latched 1 = Event is latched</p>

Internet Protocol View

The Internet Protocol view shows the IP settings for the configurable digital I/O module. You can perform certain tasks only when the project is online.

Use the Internet Protocol view to complete the following tasks:

- Select how IP settings are configured.
- Configure IP settings manually.
- Set Domain and Host Names.
- Configure Primary and Secondary DNS Server Addresses.
- Refresh communication.

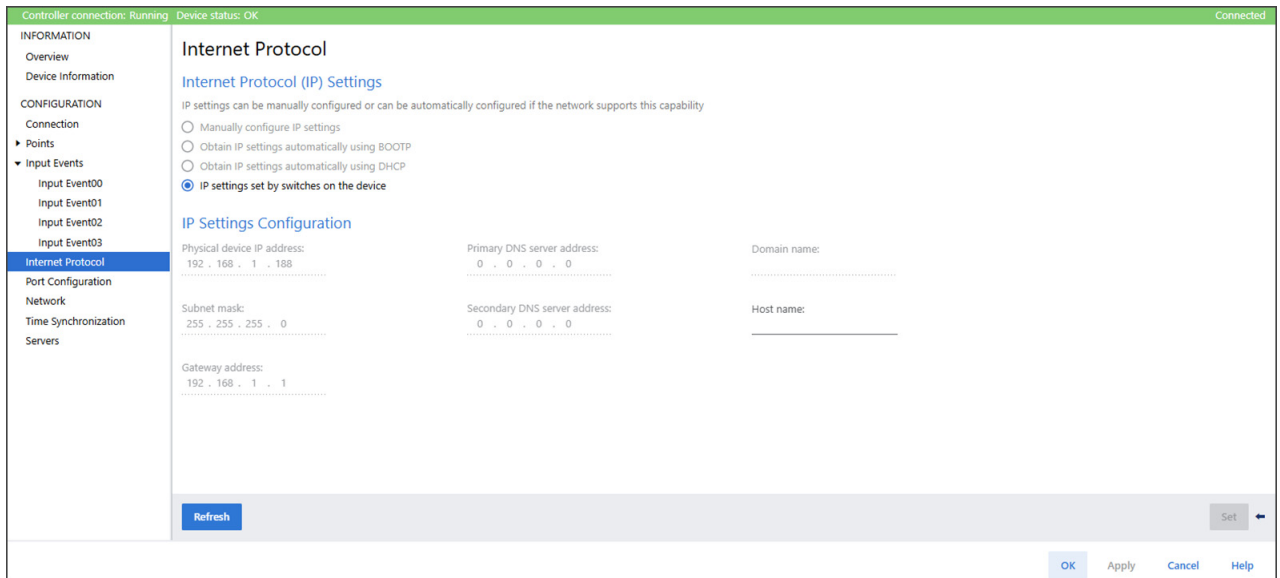

Port Configuration View

The Port Configuration view shows the status information of the network ports. You can perform certain tasks only when the project is online.

Use the Port Configuration view to complete the following tasks:

- Enable/disable network ports.
- Enable/disable Auto-Negotiate.
- Select communication speed.
- Select Duplex mode.
- Access Port Diagnostics.

Port	Enable	Link Status	Auto-Negotiate	Speed		Duplex		Port Diagnostics
				Selected	Current	Selected	Current	
1	<input checked="" type="checkbox"/>	Active	<input checked="" type="checkbox"/>		100 Mbps		Full	
2	<input checked="" type="checkbox"/>	Active	<input checked="" type="checkbox"/>		100 Mbps		Full	

Network View

The Network view shows the status information that is related to the Device Level Ring (DLR) Network Mode when the project is online.

Network mode: Device Level Ring (DLR) Network status: Normal

Network topology: Linear/Star

Time Synchronization View

The Time Synchronization view shows information that is related to CIP Sync Time Synchronization. The information appears only if the project is online and CIP Sync is enabled.

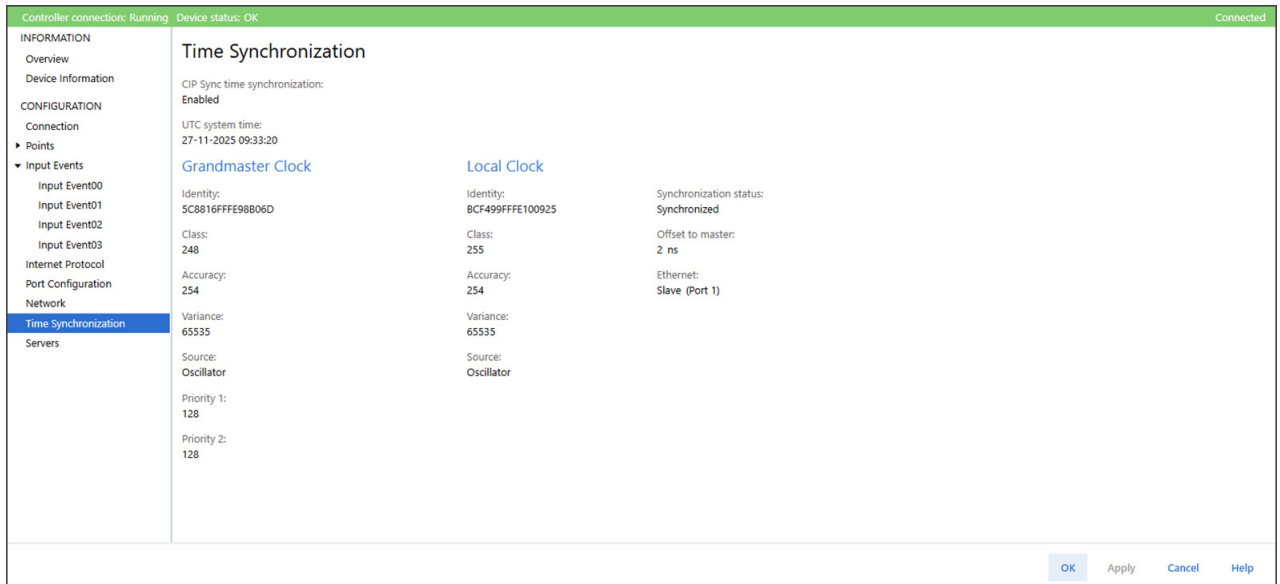

Table 19 - Time Synchronization Parameters

Parameter	Description
CIP Sync Time Synchronization	Displays the status of the time synchronization
UTC System Time	Displays the current system time
Grandmaster Clock	
Identity	Displays the unique identifier for the Grandmaster clock. The format depends on the network protocol. Ethernet network encodes the MAC ID into the identifier.
Class	Displays a measure of the quality of the Grandmaster clock. Values are defined from 0...255 with zero as the best clock.
Accuracy	Indicates the expected absolute accuracy of the Grandmaster clock relative to the PTP epoch. The accuracy is specified as a graduated scale that starts at 25 nanoseconds and ends at greater than 10 seconds or unknown. The lower the accuracy value, the better the clock.
Variance	Displays the measure of inherent stability properties of the Grandmaster clock. The value is represented in offset scaled log units. The lower the variance, the better the clock.
Source	Displays the time source of the Grandmaster clock. The available values are: <ul style="list-style-type: none"> • PTP • Oscillator
Priority 1/Priority 2	Displays the relative priority of the Grandmaster clock to other clocks in the system. The priority values range from 0...255. The highest priority is zero. The default value for both settings is 128.
Local Clock	
Synchronization Status	Displays whether the local clock is synchronized or not synchronized with the Grandmaster reference clock. A clock is synchronized if it has one port in the slave state and is receiving updates from the time master.
Offset to Master	Displays the amount of deviation between the local clock and the Grandmaster clock in nanoseconds.
Ethernet	Displays the state of the Ethernet port. The available values are: Initializing, Faulty, Disabled, Listening, PreMaster, Master, Passive, Uncalibration, Slave, or None.
Identity	Displays the unique identifier for the local clock. The format depends on the network protocol. Ethernet network encodes the MAC ID into the identifier.
Class	Displays a measure of quality of the local clock. Values are defined from 0...255, with zero as the best clock.

Table 19 - Time Synchronization Parameters (Continued)

Parameter	Description
Accuracy	Indicates the expected absolute accuracy of the Grandmaster clock relative to the PTP epoch. The accuracy is specified as a graduated scale that starts at 25 nanoseconds and ends at greater than 10 seconds or unknown. The lower the accuracy value, the better the clock.
Variance	Displays the measure of inherent stability properties of the local clock. The value is represented in offset scaled log units. The lower the variance, the better the clock.
Source	Displays the time source of the Grandmaster clock. The available values are: <ul style="list-style-type: none"> • PTP • Oscillator

Servers View

The Servers view shows information about the servers for the configurable digital I/O module.

Use the Servers view to complete the following tasks:

- Enable or disable the SNMP server.
- Enable or disable the HTTPS server.

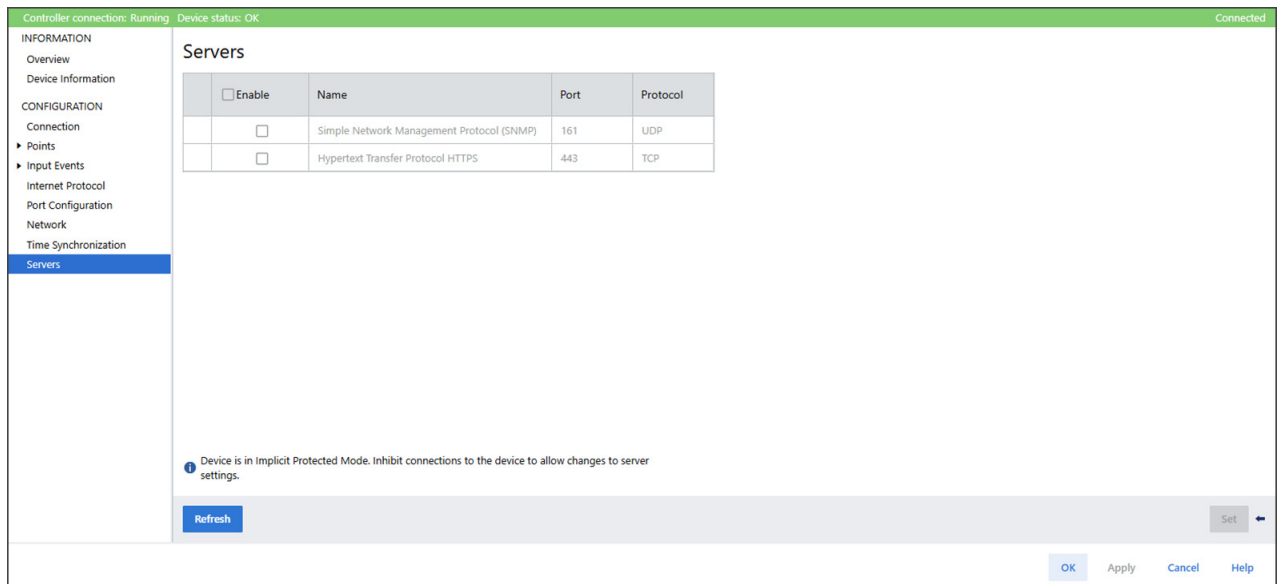

- IMPORTANT** The Servers view is not available under the following conditions:
- While the module is being created (New Module dialog)
 - While the project is offline

Enable or Disable the SNMP or HTTPS Server

The SNMP and HTTPS servers are disabled by default. If you disable the server with the addition of Protection Mode you can decrease the possibility of a security breach.

Verify that the module is not in Protection Mode. To exit Protection mode, see [Protection Mode on page 26](#) for instructions.

To enable or disable the SNMP or HTTPS Server, complete the following steps.

1. Go online with your project.
2. In the Module Properties > Servers view, select or clear the Enable checkbox and select Apply.

You do not need to cycle power to the module for the changes to take effect.

Time-scheduled Output Control

Schedule Outputs Using MAOC

To use an MAOC instruction with Scheduled Outputs on an ArmorBlock 5000 16-channel configurable digital I/O module, complete the following steps:

1. If necessary, add an ArmorBlock 5000 configurable digital I/O module to your Studio 5000 Logix Designer application project.

For more information on how to add an ArmorBlock 5000 configurable digital I/O module to a Studio 5000 Logix Designer application and configure the module, see [Add the Module to a Studio 5000 Logix Designer Application Project on page 50](#).

2. From the module properties Overview page, select Device definition.

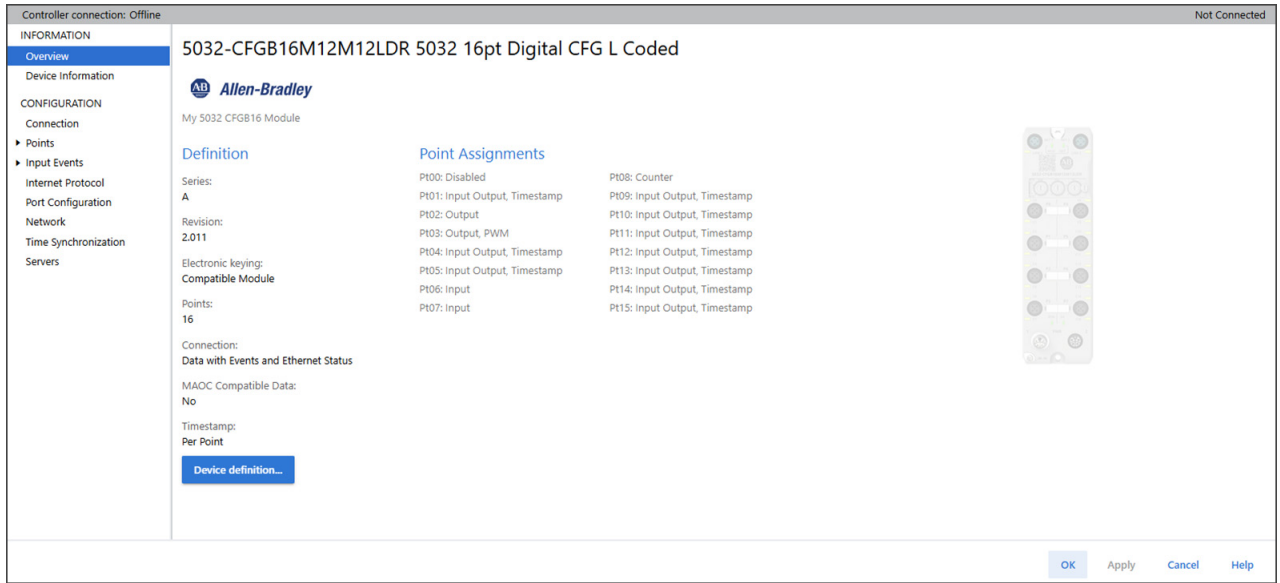

3. On the Device Definition view, select Data for Connection and select Yes for MAOC Compatible Data.

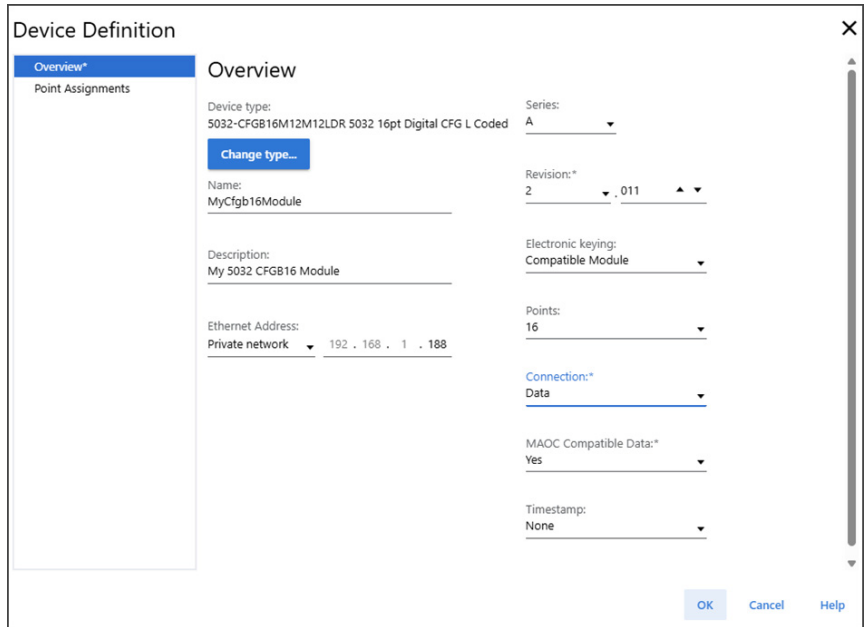

4. Select Point Assignments and set your desired points to "Output, Scheduled".
5. To close the Module Properties view, select OK.
6. Add an MAOC instruction to your logic.

7. In the MAOC instruction, use the module output tag in the Output operand, for example *My16CFGdevice:O*.

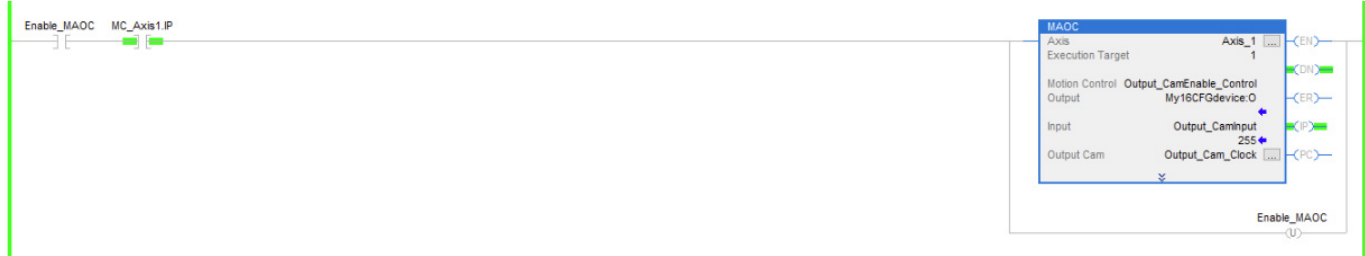

IMPORTANT Before you trigger the digital output channels from MAOC, make sure that the value of output tag `Schedule[x].ID` is 0 for all 32 output schedules.

Example of Output Tag `Schedule[0]` Set to 0

Name	Value
My16CFGdevice:O.Schedule	{...}
My16CFGdevice:O.Schedule[0]	{...}
My16CFGdevice:O.Schedule[0].ID	0
My16CFGdevice:O.Schedule[0].SequenceNumber	0
My16CFGdevice:O.Schedule[0].OutputPointSelect	0
My16CFGdevice:O.Schedule[0].Data	0
My16CFGdevice:O.Schedule[0].TimeOffset	0

For more information on how to use an MAOC instruction in general, see the following:

- Logix 5000 Controllers Motion Instructions Reference Manual, publication [MOTION-RM002](#)
- Position-based Output Control with the MAOC Instruction Application Technique, publication [1756-AT017](#)

Schedule Outputs Without Using MAOC

This mode is only available with firmware revision 2.011 or later. In this mode you can combine scheduled output operation with any supported input operation, which helps to provide better flexibility for implementation.

In this configuration, only 16 schedules are supported. Set the desired channel to Output, Scheduled or Output, Scheduled, PWM. You can schedule output as well as PWM.

IMPORTANT Before Scheduled PWM functions, you must enable PWM during configuration and define the PWM cycle time and Duty Cycle in the output tags.
If PWM is enabled (`C.PWMxx.Enable = 1`), Schedule is enabled (`O.Ptxx.ScheduleEn = 1`) and the output is instructed to turn On/Off (`O.Scheduled[x].Data`), the output generates/stops a PWM signal else it behaves like Output, Scheduled.

IMPORTANT In case of Output, Scheduled, PWM, PWM is enabled (`C.PWMxx.Enable = 1`), Schedule is enabled (`O.Ptxx.ScheduleEn = 1`) and cycle count is enabled (`PWMxx.CycleCoutEn = 1`), schedule(s) for this channel is discarded.

IMPORTANT When a PWM is stopped using the Scheduled timed output mechanism, the last PWM pulse output completes and then stops, instead of stopping immediately.

If you are not using MAOC instructions for scheduled output, you must:

1. Set MAOC Compatible Data to No in Device Definition/Overview.
2. Adjust O.TimeBase manually to create schedule entries. With a specific TimeBase, the schedule time offset is up to ± 2 seconds.

For example:

1. An application gets five schedules to send to Module.
Current Time = 9:10:05.000000000
TimeBase = 9:11:08.000000000
Schedules to send =
 - a. 9:10:20.000000000
 - b. 9:10:22.000000000
 - c. 9:10:23.000000000
 - d. 9:10:24.000000000
 - a. 10:10:23.000000000
2. Set TimeBase to 9:10:22.000000000 and send schedule a (with TimeOffset as -2 seconds), b (with TimeOffset as 0 seconds), and c (with TimeOffset as 1 second) to Module.
3. Wait until schedules a, b, and c are acknowledged by Module. Set TimeBase to 9:10:24.000000000 and send schedule d (with TimeOffset as 0 seconds) to Module.
4. Wait until schedule d is acknowledged by Module. Set TimeBase to 10:10:23.000000000 and send schedule e to Module.

IMPORTANT Once the schedule entries that are based on the current TimeBase are echoed back with the same sequence numbers by the module (this typically happens within 2 RPIs from new sequence numbers are set in the output tag), a new TimeBase can be set to incorporate new schedule entry creations.

IMPORTANT Always set Schedule[x].SequenceNumber as the last step of Schedule[x] entry creation in the output tag.

IMPORTANT You can monitor Schedule[x].State in the input tag to verify that the schedule is performed correctly.

IMPORTANT With firmware revision 2.011 or later, when Ptxx.ScheduleEn is used to disable scheduling, you can control outputs manually and upon re-enabling the schedule, the output goes to low.

Time-scheduled Output Control with PWM (Scheduled PWM)

This feature is only available with firmware revision 2.011 or later.

This feature functions the same way as Time-scheduled Output Control, except that instead of controlling On or Off states, the data bit O.Schedule[n].Data controls the start and stop of the pulse generation. The PWM Cycle Count Limit is not supported for Scheduled PWM. If PWM Cycle Count Limit (C.Pwmxx.CycleCountEn) is enabled, Scheduled PWM entries are discarded.

When Scheduled PWM is used, the O.Pwmxx.CycleTime and O.Pwmxx.DutyCycle are always applied immediately after the module receives the consume data (that is, queuing scheduled entries with different cycle time or duty cycle is not supported).

IMPORTANT To use Scheduled PWM, you must set MAOC Compatible Data to No in the Device Definition.

An output point, which is configured as Scheduled PWM, can operate in the following ways that are listed in [Table 20](#).

Table 20 - Output Point Functional Behavior

C.Pwmxx.Enable	O.Ptxx.ScheduleEn	Description
0	0	The output point functions as a simple digital output. The <i>O.Ptxx.Data</i> bit controls the output state.
0	1	The output point functions as a scheduled output. The <i>O.Schedule[n].Data</i> bit controls the output state.
1	0	The output point functions as PWM output. The <i>O.Ptxx.Data</i> bit controls the output PWM generation.
1	1	The output point functions as a Scheduled PWM output. The <i>O.Schedule[n].Data</i> bit controls the output PWM generation.

Reset Module to Factory Default

When you reset the ArmorBlock 5000 configurable digital I/O module to factory default, all parameters are reset to their default values and all Data Storage copies on the module are cleared.

To reset the module to factory default, complete these steps.

1. Power down the module.
2. Set the network address switches to 888.
3. Power up the module.

For more information on the network address switches, see [Set the Network Address Switches on page 49](#).

Notes:

Troubleshoot Your Configurable Digital I/O Module

This appendix describes how to identify and troubleshoot issues with your ArmorBlock 5000 16-channel configurable digital I/O module.

Module Status Indicator

[Table 21](#) describes the module status indicator for the ArmorBlock 5000 16-channel configurable digital I/O module.

Table 21 - Module Status Indicator

Indicator State	Description	Recommended Action
Off	The module is not powered.	Apply power as necessary.
Steady green	The module is operating in a normal condition.	None
Flashing green	The IP address is not set.	Set the IP address using one of the recommended methods. For more information, see Configure the Configurable Digital I/O Module on page 49 .
Steady red	The module experienced a nonrecoverable fault.	Cycle power to the module. If the fault persists, replace the module.
Flashing red	One of the following conditions exists: <ul style="list-style-type: none"> A module firmware update is in progress. IP address switches do not match the configuration in use. The device has a recoverable fault. See the module diagnostics for more information. The module has powered up and is in the Factory Default state. In this case, all other indicators flash red and green. 	Complete one of the following: <ul style="list-style-type: none"> Wait for the firmware update to finish. Cycle power to the module. Use module as necessary.
Flashing red/green	The module is performing a POST (power on self test), which completes within 30 seconds.	None

Network Status Indicator

[Table 22](#) describes the network status indicator for the ArmorBlock 5000 16-channel configurable digital I/O module.

Table 22 - Network Status Indicator

Indicator State	Description	Recommended Action
Off	The module is not configured or does not have an IP address.	Configure the module or assign an IP address.
Steady green	The module has an IP address and at least one established active connection.	None
Flashing green	The module has an IP address, but no active connections are established.	Establish connections as required by the project.
Steady red	There is a duplicate IP address condition or invalid configuration.	Troubleshoot the issue and remedy the cause. For example, if a duplicate IP address condition exists, determine which devices on the network use the same IP address and change the IP address to unique values.
Flashing red	One or more connections have timed out.	Use module as necessary.

Link Status Indicator

[Table 23](#) describes the link status indicator for the ArmorBlock 5000 16-channel configurable digital I/O module.

Table 23 - Link 1 and Link 2 Status Indicator

Indicator State	Description	Recommended Action
Off	One of the following conditions exists: <ul style="list-style-type: none"> The module is not powered. The Ethernet cables are not properly seated in the module and connected devices. No link has been established. The port is administratively disabled. The port configuration is configured in a manner that can result in issues. For example, the port can be configured to Autonegotiate and the port at the other end of the cable is configured such that Autonegotiate is disabled. 	Complete one of the following: <ul style="list-style-type: none"> Apply power as necessary. Verify that the cables are properly seated in the module and connected devices. Check if the port is disabled in the Studio 5000 Logix Designer application and confirm if that is the desired state. Check the configuration for the links at both ends of the cable and verify that they are correct to perform normal operations.
Steady green	Link has been established on the indicated port at 100 Mbps.	None
Flashing green	Link activity exists on the indicated port at 100 Mbps.	None
Steady yellow	Link is established on the indicated port at 10 Mbps.	None
Flashing yellow	Link activity exists on the indicated port at 10 Mbps.	None

Power Status Indicator

[Table 24](#) describes the MSA power and [Table 25](#) describes the LA power status indicator for the ArmorBlock 5000 16-channel configurable digital I/O module.

Table 24 - MSA Power Status Indicator

Indicator State	Description	Recommended Action
Off	There is no MSA power.	Apply power as necessary.
Steady green	MSA power is within the valid range of 18...30V.	None
Flashing red	MSA power is outside the valid range of 18...30V.	Verify that the power supply meets the module specifications.

Table 25 - LA Power Status Indicator

Indicator State	Description	Recommended Action
Off	There is no MSA power.	Apply power as necessary.
Steady green	LA power is within valid range of 18...30V.	None
Flashing red	One of the following conditions exists: <ul style="list-style-type: none"> There is no LA power. LA power is outside the valid range of 18...30V. 	Complete one of the following: <ul style="list-style-type: none"> Apply power as necessary. Verify that the power supply meets the module specifications.

Point Status Indicator

[Table 26](#) describes the point status indicator for the ArmorBlock 5000 16-channel configurable digital I/O module.

Table 26 - Point Status Indicator

Point Mode	Indicator State	Description	Recommended Action
DI	Off	The input is off.	None
	Steady yellow	The input is on.	None
	Flashing red	Port 0...Port 3: Short circuit/overload condition or SA power on the port is faulted. Port 4...Port 7: Short circuit/overload condition or LA power on the port is faulted.	Correct the short circuit condition or power fault.
DO	Off	The output is off.	None
	Steady yellow	The output is on.	None
	Flashing red	Port 0...Port 3: Short circuit/overload condition or SA power on the port is faulted. Port 4...Port 7: Short circuit/overload condition or LA power on the port is faulted.	Correct the output short circuit condition, or SA/LA power fault.

Troubleshoot Wiring Issues

[Table 27](#) describes the possible faults that can occur due to incorrect usage or when wiring the ArmorBlock 5000 16-channel configurable digital I/O module.

Table 27 - Possible Faults due to Incorrect Usage or Wiring

System/Function	Fault	Description	Recommended Action
Power Port			
POWER IN	Lower/higher voltage input used	Module unable to operate. Next module in daisy chain unable to operate.	Complete the following steps: 1. Verify that the system is powered. 2. Verify that the POWER Input is within the operating voltage range.
POWER OUT Used to provide power to another daisy chained module as input to POWER IN.	Unable to provide enough power	Module unable to operate. Next module in daisy chain unable to operate.	Complete the following steps: 1. Verify that the system is powered. 2. Verify that all modules in the daisy chain receive sufficient power. 3. Verify that the power passing through the daisy chain is within the specifications of the module.
POWER IN	Reversed polarized power input used	Module unable to power up. No damage is caused to module.	Complete the following steps: 1. Verify that the system is powered. 2. Verify that the power cable wiring is installed properly.
I/O Port			
Configurable I/O	Configured as output but wired as input. Two operating outputs are joined.	Module operates. However, a fault is reported if excess current is drawn from the module due to the difference in potentials and the affected point switches off.	Complete the following steps: 1. Verify that the cable is installed properly. 2. Check the point status indicators. If the indicator is showing flashing red, confirm that the I/O cable is installed properly.

Use the Studio 5000 Logix Designer Application for Troubleshooting

The Studio 5000 Logix Designer application indicates the presence of fault conditions.

Fault conditions are reported in the following ways:

- [Warning Signal in the I/O Configuration Tree](#)
- [Status and Fault Information in Module Properties](#)
- [Diagnostics in Studio 5000 Logix Designer Application](#)
- [Studio 5000 Logix Designer Application Tag Editor](#)

Warning Signal in the I/O Configuration Tree

As shown in [Figure 11](#), a warning icon appears in the I/O Configuration tree when a fault occurs.

Figure 11 - Warning Icon in I/O Configuration Tree



Status and Fault Information in Module Properties

The Module Properties window in the Studio 5000 Logix Designer application includes a series of views for the configurable digital I/O module. The numbers and types of views depend on the module configuration.

Each view includes options to configure the module or monitor the status of the module. The following are ways to monitor the state of a module for faults:

- [Device Status on Module Properties Window](#)
- [Device Fault Descriptions on Connection View](#)
- [Device Fault Information and Diagnostics on Device Information View](#)

Device Status on Module Properties Window

Figure 12 shows where the status of a module is indicated on the Module Properties Overview window.

Figure 12 - Fault Message in Status Line

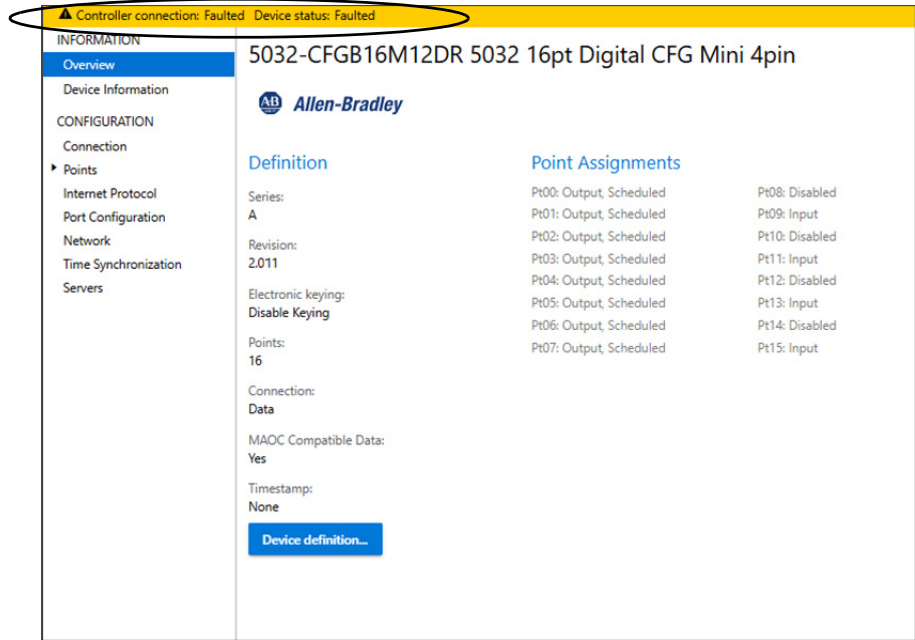

Device Fault Descriptions on Connection View

Figure 13 shows where a module fault description, which includes an error code that is associated with the specific fault type, is indicated on the Connection view.

Figure 13 - Fault Description with Error Code

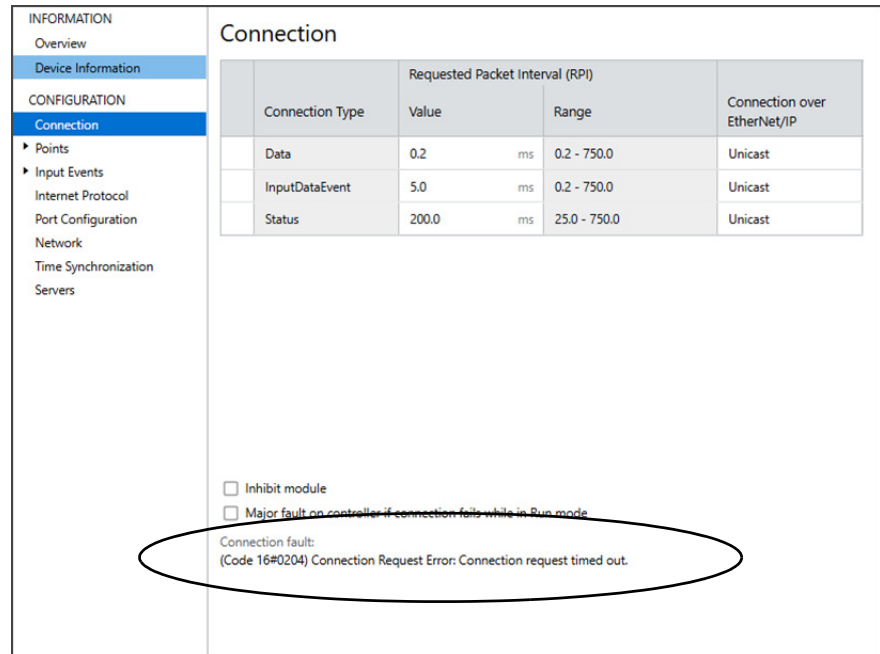

Device Fault Information and Diagnostics on Device Information View

Figure 14 shows where the major and minor fault information, and where to access module diagnostic information are indicated on the Device Information view.

Figure 14 - Major and Minor Fault Information and Diagnostics

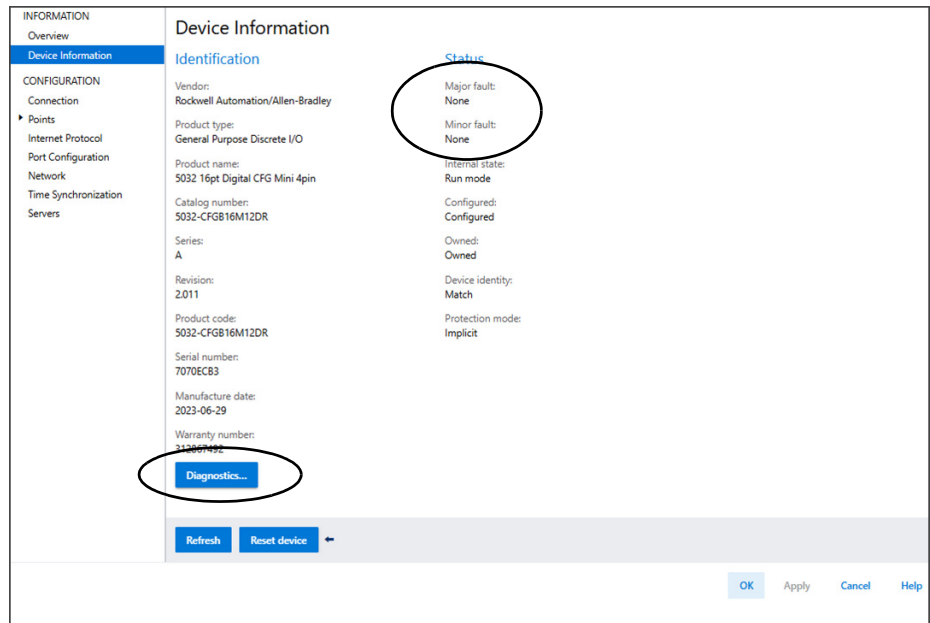

Diagnostics in Studio 5000 Logix Designer Application

You can use diagnostics in the Studio 5000 Logix Designer application to monitor the module and/or point operating conditions and to troubleshoot issues that affect a module and/or point. You can use diagnostics only when the project is online.

The following are the different diagnostics that you can monitor:

- [Device Diagnostics](#)
- [Port Diagnostics](#)
- [Ptxx Diagnostics](#)

Device Diagnostics

[Figure 15](#) shows the Device Diagnostics, which provides information on a module-wide basis.

To access the Device Diagnostics, see [Device Information View on page 59](#).

Figure 15 - Device Diagnostics

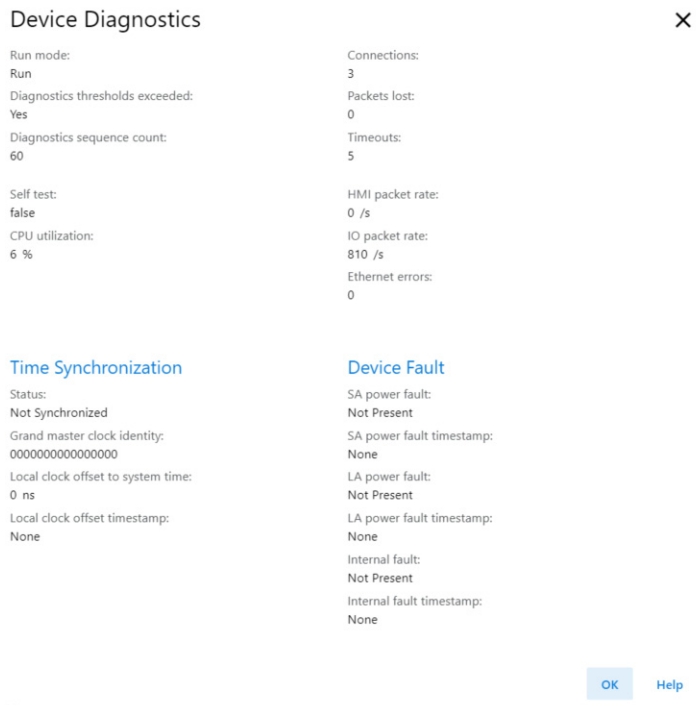

Port Diagnostics

[Figure 16](#) shows the Port Diagnostics, which provide information on an individual port basis.

To access the Port Diagnostics, see [Port Configuration View on page 73](#).

Figure 16 - Port Diagnostics

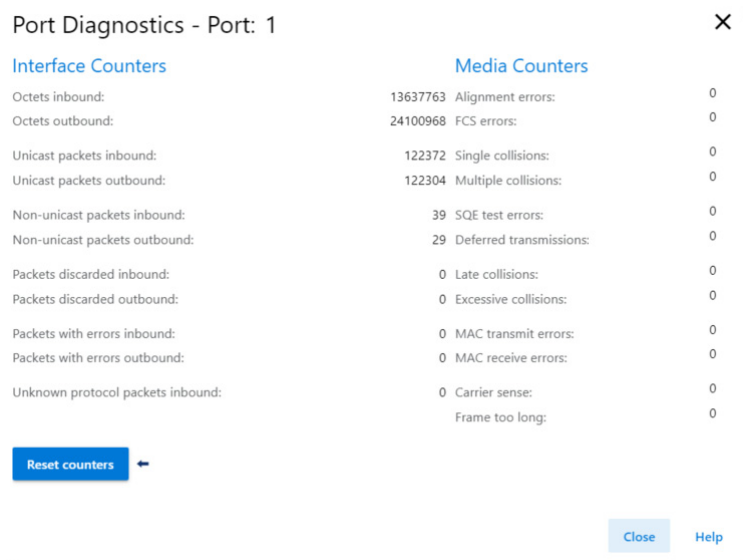

Ptxx Diagnostics

Figure 17 shows the Ptxx Diagnostics, which provide information on an individual point basis.

To access the Ptxx Diagnostics, see [Points View on page 60](#).

Figure 17 - Ptxx Diagnostics

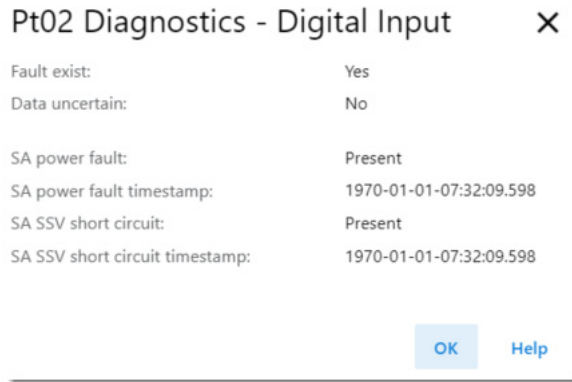

Studio 5000 Logix Designer Application Tag Editor

Figure 18 shows how fault conditions are indicated in the controller tags for the module.

Figure 18 - Fault Indication in Controller Tags for Configurable Digital I/O Module

Name	Value	Force Mask	Style	Data Type
My16cfgModule:C	{...}	{...}	{...}	AB:5000_DI14_DO...
My16cfgModule:I	{...}	{...}	{...}	AB:5000_DI14_DO...
My16cfgModule:I.RunMode	1		Decimal	BOOL
My16cfgModule:I.ConnectionFaulted	0		Decimal	BOOL
My16cfgModule:I.DiagnosticActive	1		Decimal	BOOL
My16cfgModule:I.CIPSyncValid	0		Decimal	BOOL
My16cfgModule:I.CIPSyncTimeout	0		Decimal	BOOL
My16cfgModule:I.DiagnosticSequenceCount	60		Decimal	SINT
My16cfgModule:I.Pt01	{...}	{...}	{...}	CHANNEL_DO:t:0
My16cfgModule:I.Pt01.Data	0		Decimal	BOOL
My16cfgModule:I.Pt01.Fault	0		Decimal	BOOL
My16cfgModule:I.Pt01.Uncertain	0		Decimal	BOOL
My16cfgModule:I.Pt02	{...}	{...}	{...}	CHANNEL_DI:t:0

Module Diagnostic Webpages

You can use the diagnostic webpages of the ArmorBlock 5000 16-channel configurable digital I/O module to help troubleshoot possible problems with your EtherNet/IP communication.

IMPORTANT

Consider the following:

- The diagnostic webpages are disabled by default. You can enable the diagnostic webpages for the module if the module is not in Explicit Protection Mode.
- For more information on how to troubleshoot problems that you diagnose, see the Troubleshoot EtherNet/IP Networks Application Technique, publication [ENET-AT003](#).

The diagnostic webpages for the module include the following:

- Diagnostic Overview - Shows the status of the module
- Network Settings - Shows the settings for the Network Interface, Ethernet Interface Configuration, and the Ethernet ports of the module
- IO Connections - Shows the status of the I/O connections of the module
- Ethernet Statistics - Shows the status of communication activity on the Ethernet network

To access the module diagnostic webpages, complete these steps.

1. Open your web browser.
2. In the Address field, type the IP address of the module and press Enter. The Home webpage appears.
3. Open the Diagnostics Overview page under the Diagnostics view.

Rockwell Automation 5032-CFGB16M12M12LDR

Home

▼ Diagnostics

Diagnostic Overview

Network Settings

IO Connections

Ethernet Statistics

Diagnostic Overview

Refresh Interval(Disable refresh with 0):

Module Resource Utilization (All Ports)

CPU	7 %
I/O Comms Utilization	2 %

I/O Packets Per Second (EtherNet/IP Port)

Total	400
Sent	200
Received	200

CIP Connection Statistics (All Ports)

Active total	1
Active Class 3	0
Active I/O	1
Maximum Total Supported	31

I/O Packet Counts (EtherNet/IP Port)

Missed	0
--------	---

TCP Connections (Ethernet/IP Port)

Active	1
Maximum Supported	32

Explicit Messages

Packets Sent and Received Per Second	0
--------------------------------------	---

Configurable Digital I/O Module Device Definitions

When you create a configurable digital I/O module, the Studio 5000 Logix Designer application creates a set of tags that you can view in the Tag Editor. Each configured feature on your module has a distinct tag that is available for use in the controller ladder program.

Tag Name Conventions

The tag names use defined naming conventions. The conventions are as follows:

Example module tag name = *Name:I.Pt01.Data*

- Name = Name of the module
- I = Tag type
- Pt01 = Module point number
- Data = Tag function

In this example, Data represents the input data that is returned to the controller.

Access the Tags

You view tags from the Tag Editor.

1. Open your Studio 5000 Logix Designer application project.
2. Right-click Controller Tags and select Monitor Tags.

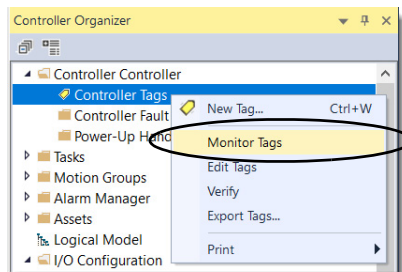

3. Open the tags as necessary to view specific tags.

Name	Value	Force Mask	Style	Data Type
My16CFGModule:C	{...}	{...}		AB:5000_DI14_DO1_4924D04924A1:C:0
My16CFGModule:C.Pt01	{...}	{...}		AB:5000_DO_Channel:C:0
My16CFGModule:C.Pt01.FaultMode	0		Decimal	BOOL
My16CFGModule:C.Pt01.FaultValue	0		Decimal	BOOL
My16CFGModule:C.Pt01.ProgMode	0		Decimal	BOOL
My16CFGModule:C.Pt01.ProgValue	0		Decimal	BOOL
My16CFGModule:C.Pt01.FaultFinalState	0		Decimal	BOOL
My16CFGModule:C.Pt01.ProgramToFaultEn	0		Decimal	BOOL
My16CFGModule:C.Pt01.FaultValueStateDuration	0		Decimal	SINT
My16CFGModule:C.Pt02	{...}	{...}		AB:5000_DI_Channel:C:0

Module Tags

This section describes the tags that are available for the ArmorBlock 5000 16-channel configurable digital I/O module. The tables contained in this section list all tags that are available for the device. Not all tags in the lists are used when the module is added to a project. Tag use varies by device configuration.

The following types of tags are available:

- [Configuration Tags](#) (as indicated by a 'C')
- [Input Tags](#) (as indicated by an 'I')
- [Output Tags](#) (as indicated by an 'O')
- [Event Input Tags](#) (as indicated by an 'EI')
- [Event Output Tags](#) (as indicated by an 'EO')
- [Status Tags](#) (as indicated by an 'S')

Configuration Tags

[Table 28](#) describes the available configuration tags ('C').

Table 28 - Configurable Digital I/O Module Configuration Tags

Name	Data Type	Definition	Valid Values
Counterxx.InputOffOnFilter	SINT	The amount of time that a signal must be in the On state before the input data indicates the On state. The amount of time is indicated using an enumeration.	<ul style="list-style-type: none"> • 0 = 0 μs (default) • 6 = 5 μs • 7 = 10 μs • 8 = 20 μs • 9 = 50 μs • 10 = 100 μs • 11 = 200 μs • 12 = 500 μs • 13 = 1 ms • 14 = 2 ms • 15 = 5 ms • 16 = 10 ms • 17 = 20 ms • 18 = 50 ms
Counterxx.InputOnOffFilter	SINT	The amount of time that a signal must be in the Off state before the input data indicates the Off state. The amount of time is indicated using an enumeration.	<ul style="list-style-type: none"> • 0 = 0 μs (default) • 6 = 5 μs • 7 = 10 μs • 8 = 20 μs • 9 = 50 μs • 10 = 100 μs • 11 = 200 μs • 12 = 500 μs • 13 = 1 ms • 14 = 2 ms • 15 = 5 ms • 16 = 10 ms • 17 = 20 ms • 18 = 50 ms
Counterxx.RolloverAtPreset	BOOL	Set the counter to roll over to 0 at the preset value.	<ul style="list-style-type: none"> • 0 = Do not roll over (default) • 1 = Rollover

Table 28 - Configurable Digital I/O Module Configuration Tags (Continued)

Name	Data Type	Definition	Valid Values
Ptx.InputOffOnFilter	SINT	The amount of time that a signal must be in the On state before the input data indicates the On state. The amount of time is indicated using an enumeration.	<ul style="list-style-type: none"> • 0 = 0 μs (default) • 6 = 5 μs • 7 = 10 μs • 8 = 20 μs • 9 = 50 μs • 10 = 100 μs • 11 = 200 μs • 12 = 500 μs • 13 = 1 ms • 14 = 2 ms • 15 = 5 ms • 16 = 10 ms • 17 = 20 ms • 18 = 50 ms
Ptx.InputOnOffFilter	SINT	The amount of time that a signal must be in the Off state before the input data indicates the Off state. The amount of time is indicated using an enumeration.	<ul style="list-style-type: none"> • 0 = 0 μs (default) • 6 = 5 μs • 7 = 10 μs • 8 = 20 μs • 9 = 50 μs • 10 = 100 μs • 11 = 200 μs • 12 = 500 μs • 13 = 1 ms • 14 = 2 ms • 15 = 5 ms • 16 = 10 ms • 17 = 20 ms • 18 = 50 ms
Ptx.ChatterTime	INT	The amount of time within which the number of input transitions are counted.	1...10000 ms
Ptx.ChatterCount	SINT	The number of input transitions that are considered chatter. Chatter can cause the module to timestamp invalid input transitions. Chatter signals cause inputs to transition falsely many times in a relatively short period.	<ul style="list-style-type: none"> • 0 = Disabled (default) • 2...127 = Enabled
Ptx.CaptureOffOnEn	BOOL	Set to capture a timestamp when the input transitions from Off to On.	<ul style="list-style-type: none"> • 0 = Do not capture (default) • 1 = Capture
Ptx.CaptureOnOffEn	BOOL	Set to capture a timestamp when the input transitions from On to Off.	<ul style="list-style-type: none"> • 0 = Do not capture (default) • 1 = Capture
Ptx.TimestampLatchEn	BOOL	Set to latch timestamps. When a timestamp is latched, you must acknowledge it to overwrite the timestamp.	<ul style="list-style-type: none"> • 0 = Do not latch (default) • 1 = Latch
Ptx.FaultMode	BOOL	Determines the action that the output takes when a connection fault occurs. At fault occurrence, the output holds its last state or transitions to the value set in <i>FaultValue</i> . The point continues this action for the length of time set in <i>FaultValueStateDuration</i> .	<ul style="list-style-type: none"> • 0 = Transition to user-defined value (default) • 1 = Hold last state
Ptx.FaultValue	BOOL	Defines the state that the output assumes if a communication fault occurs when <i>FaultMode</i> = 0.	<ul style="list-style-type: none"> • 0 = Output is off (default) • 1 = Output is on
Ptx.ProgMode	BOOL	Determines the action that the output takes when the controller transitions to Program mode or the connection to the module is inhibited. At the transition to Program mode, the output holds its last state or transitions to the value set in <i>ProgValue</i> .	<ul style="list-style-type: none"> • 0 = Transition to user-defined value (default) • 1 = Hold last state
Ptx.ProgValue	BOOL	Defines the state that the output assumes when the connection transitions to Program mode when <i>ProgMode</i> = 0.	<ul style="list-style-type: none"> • 0 = Output is off (default) • 1 = Output is on
Ptx.FaultFinalState	BOOL	If <i>FaultValueStateDuration</i> is nonzero, set the final output state after the configured <i>FaultValueStateDuration</i> timeout occurs.	<ul style="list-style-type: none"> • 0 = Output is off (default) • 1 = Output is on

Table 28 - Configurable Digital I/O Module Configuration Tags (Continued)

Name	Data Type	Definition	Valid Values
Ptxx.FaultValueStateDuration	SINT	Set the length of time that the <i>FaultMode</i> state is held before the <i>FinalFaultState</i> is applied.	<ul style="list-style-type: none"> 0 = Forever (default) 1 = 1 s 2 = 2 s 5 = 5 s 10 = 10 s
Ptxx.ProgramToFaultEn	BOOL	Determines if the output transitions to Fault mode when the connection faults while in Program mode.	<ul style="list-style-type: none"> 0 = Remain in Program mode (default) 1 = Transition to Fault mode
FIFOLatchEvents	BOOL	Latches events so that an event is not overwritten until acknowledged. Latched means that a sequence of events of LO to HI and HI to LO then LO to HI cause the first LO to HI transition to be recorded and the final LO to HI to be ignored. All subsequent transitions on that point are ignored until acknowledged/reset. If the bit is not set, the new LO to HI overwrites the first LO to HI event immediately, even if the controller has yet to extract that data.	<ul style="list-style-type: none"> 0 = SOE not latched 1 = SOE latched (default)
Pwmxx.Enable	BOOL	Determines whether the output is Pulse Width Modulation or Digital Output.	<ul style="list-style-type: none"> 0 = Output is used as Digital Output. 1 = Output is used as Pulse Width Modulation Output.
Pwmxx.CycleCountEn	BOOL	Indicates whether to stop generating pulse cycles after a defined number or continue generating pulse cycles until stopped.	<ul style="list-style-type: none"> 0 = Continue generating pulse cycles until stopped 1 = Generate a defined number of output pulse cycles
Pwmxx.ExecuteAllCycles	BOOL	Indicates whether pulses continue generating to complete the pulse cycle count when Data is set to 0, or stops immediately.	<ul style="list-style-type: none"> 0 = Output state immediately turns off. 1 = Output state continues to generate the pulses.
Pwmxx.EnforcePTODutyCycle	BOOL	Indicates whether to enforce the PTO specific duty cycle, which is fixed at 50%.	<ul style="list-style-type: none"> 0 = 0.Pwmxx.DutyCycle is used. 1 = 50% duty cycle is used. 0.Pwmxx.DutyCycle is ignored.
Pwmxx.IdleState	BOOL	Indicates the output state when the PWM pulse sequence is not running (PWM is idle).	0 = When PWM is idle, the output state is Off. If set to 1, the configuration is rejected.

Input Tags

[Table 29](#) describes the available input tags ('1').

Table 29 - Configurable Digital I/O Module Input Tags

Name	Data Type	Definition	Valid Values
RunMode	BOOL	Indicates the operating state of the input	<ul style="list-style-type: none"> 0 = Idle 1 = Run mode
ConnectionFaulted	BOOL	Indicates if a connection is running. The module sets this tag to 0 when connected. If the module is not connected, it sets this tag to 1.	<ul style="list-style-type: none"> 0 = Connection running 1 = Connection not running
DiagnosticActive	BOOL	Indicates if any diagnostics are active or if the prognostics threshold is reached	<ul style="list-style-type: none"> 0 = No diagnostics active 1 = One or more diagnostics are active or the prognostics threshold is reached
CIPSyncValid	BOOL	Indicates if the module is synchronized with a 1588 master	<ul style="list-style-type: none"> 0 = Module not synchronized 1 = Module synchronized
CIPSyncTimeout	BOOL	Indicates if the module was previously synchronized with a 1588 master but is now timed out	<ul style="list-style-type: none"> 0 = A valid time master has not timed out 1 = A valid time master has timed out
DiagnosticSequenceCount	SINT	Increments each time that a distinct diagnostic condition is detected, and each time a distinct diagnostic condition transitions from detected to not detected. Reset to zero on power cycle. Wraps from 255 (-1) to 1, skipping zero.	-128...+127 The value of 0 is skipped except during module power-up.
Counterxx.Data	BOOL	Indicates the state of the input	<ul style="list-style-type: none"> 0 = Off 1 = On

Table 29 - Configurable Digital I/O Module Input Tags (Continued)

Name	Data Type	Definition	Valid Values
Counterxx.Fault	BOOL	Indicates that counter data is inaccurate and cannot be trusted for use in the application. For more information, see Fault and Status Reporting on page 17 .	<ul style="list-style-type: none"> 0 = No fault exists 1 = Fault exists If the tag is set to 1, you must troubleshoot the module to correct the cause of the inaccuracy. IMPORTANT: Once the condition that causes the tag to change to 1 is removed, the tag automatically resets to 0.
Counterxx.Uncertain	BOOL	Indicates that counter data can be inaccurate but the degree of inaccuracy is not known. For more information, see Fault and Status Reporting on page 17 .	<ul style="list-style-type: none"> 0 = Good data 1 = Uncertain data If the tag is set to 1, you must troubleshoot the module to correct the cause of the inaccuracy. IMPORTANT: Once the condition that causes the tag to change to 1 is removed, the tag automatically resets to 0.
Counterxx.Done	BOOL	When set, indicates that the corresponding counter Done bit (rising or falling depending on configuration) triggered the event	<ul style="list-style-type: none"> 0 = Corresponding <i>Done</i> bit did not trigger the event 1 = Corresponding <i>Done</i> bit triggered the event
Counterxx.Rollover	BOOL	The counter counts up to Preset -1 and continues counting from or 0. The <i>O.CounterxxRolloverAck</i> bit that transitions from 0 to 1 or the <i>O.CounterxxReset</i> that transitions from 0 to 1 clears this bit.	<ul style="list-style-type: none"> 0 = Counter has not counted up to Preset -1 1 = Counter counted up to Preset -1 and continued counting from 0
Counterxx.Count	BOOL	The number of input transitions counted by a counter	All values
Ptxx.Data	BOOL	Indicates the state of the input	<ul style="list-style-type: none"> 0 = Off 1 = On
Ptxx.Fault	BOOL	Indicates that point data is inaccurate and cannot be trusted for use in the application. For more information, see Fault and Status Reporting on page 17 .	<ul style="list-style-type: none"> 0 = Good 1 = Bad, causes fault If the tag is set to 1, you must troubleshoot the module to correct the cause of the inaccuracy. IMPORTANT: Once the condition that causes the tag to change to 1 is removed, the tag automatically resets to 0.
Ptxx.Uncertain	BOOL	Indicates that point data can be inaccurate but the degree of inaccuracy is not known. For more information, see Fault and Status Reporting on page 17 .	<ul style="list-style-type: none"> 0 = Good data 1 = Uncertain data If the tag is set to 1, you must troubleshoot the module to correct the cause of the inaccuracy. IMPORTANT: Once the condition that causes the tag to change to 1 is removed, the tag automatically resets to 0.
Ptxx.Chatter	BOOL	Indicates if the input is chattering per the <i>C.Ptxx.ChatterTime</i> and <i>C.Ptxx.ChatterCount</i> settings	<ul style="list-style-type: none"> 0 = Normal 1 = Input is chattering
Ptxx.OutputEnabled	BOOL	Indicates the Output Enabled status of the channel.	<ul style="list-style-type: none"> 0 = Channel is not enabled as Digital Output 1 = Channel is enabled as Digital Output
Ptxx.TimestampOverflowOffOn	BOOL	Indicates an Off to On timestamp was lost in a discrete product. If <i>C.Ptxx.TimestampLatchEn</i> is set, then a new timestamp was not recorded because one is already latched. If <i>C.Ptxx.TimestampLatchEn</i> is clear, then a timestamp was overwritten.	0 or 1
Ptxx.TimestampOverflowOnOff	BOOL	Indicates an On to Off timestamp was lost in a discrete product. If <i>C.Ptxx.TimestampLatchEn</i> is set, then a new timestamp was not recorded because one is already latched. If <i>C.Ptxx.TimestampLatchEn</i> is clear, then a timestamp was overwritten.	0 or 1
Ptxx.CIPSyncValid	BOOL	Indicates if the module is synchronized with a 1588 master	<ul style="list-style-type: none"> 0 = Module not synchronized 1 = Module synchronized
Ptxx.CIPSyncTimeout	BOOL	Indicates if the module was previously synchronized with a 1588 master but is now timed out	<ul style="list-style-type: none"> 0 = A valid time master has not timed out 1 = A valid time master has timed out
Ptxx.TimestampOffOnNumber	INT	An Off to On timestamp identifier for the currently produced timestamp	All values
Ptxx.TimestampOnOfNumber	INT	An On to Off timestamp identifier for the currently produced timestamp	All values
Ptxx.TimestampOffOn	LINT	64-bit timestamp that corresponds to when a change of state Off to On was recorded at the input	All values
Ptxx.TimestampOnOff	LINT	64-bit timestamp that corresponds to when a change of state On to Off was recorded at the input	All values

Table 29 - Configurable Digital I/O Module Input Tags (Continued)

Name	Data Type	Definition	Valid Values
Ptxx.NewData	SINT	Flag that indicates if new timestamp data was detected on the input. Because input data for all inputs is sent the next RPI after each timestamped transition, this tag helps determine on which input the transition occurred. For example, if the module sends new input data to the owner-controller and <i>I.NewData.5</i> = 1, you know that at least one of the timestamps for input 5 (<i>I.Timestamp[5].OffOn</i> or <i>I.Timestamp[5].OnOff</i>) has new data. This tag only clears when the controller acknowledges the new data or all events on the module are reset.	<ul style="list-style-type: none"> 0 = No new timestamp data on the input 1 = New timestamp data on the input (since last acknowledged)
Ptxx.EventOverflow	SINT	Set for an input when the module either: <ul style="list-style-type: none"> Does not timestamp a transition on the input - The module has Timestamp Latch enabled and a similar transition is already timestamped on this input but is not cleared via the <i>O.EventAck</i> and <i>O.NewDataAck</i> output tags. or <ul style="list-style-type: none"> Overwrites previously recorded timestamp data for the input - The module has Timestamp Latch disabled and multiple transitions occur on the input. In this case, timestamp data from new transitions are recorded before previously recorded transitions are cleared from the input via the <i>O.EventAck</i> and <i>O.NewDataAck</i> output tags. 	This value is cleared if the module is reset.
EventStatus[x].EventDropped	BOOL	Indicates when an event has been discarded because events are occurring faster than they are being acknowledged	<ul style="list-style-type: none"> 0 = An event status has not been dropped 1 = An event status has been dropped
EventStatus[x].CIPSyncValid	BOOL	Indicates if the module is synchronized with a 1588 master	<ul style="list-style-type: none"> 0 = Module not synchronized 1 = Module synchronized
EventStatus[x].CIPSyncTimeout	BOOL	Indicates if the module was previously synchronized with a 1588 master but is now timed out	<ul style="list-style-type: none"> 0 = A valid time master has not timed out 1 = A valid time master has timed out
EventStatus[x].EventReset	BOOL	When <i>EO.Eventxx.ResetEvent</i> transitions from 0 to 1, <i>I.EventStatus[x].EventReset</i> transitions to 1 to indicate that the reset was received and completed. It stays 1 until <i>EO.Eventxx.ResetEvent</i> transition to zero.	<ul style="list-style-type: none"> 0 = Do not reset 1 = Reset
EventStatus[x].EventsPending	SINT	The number of events currently queued in the module. A value greater than zero indicates that the controller is not currently keeping up with the rate of events.	All positive values
EventStatus[x].EventNumber	DINT	A running count of events, which increments by one each new time event. The originator sets <i>EO.Eventxx.EventNumberAck</i> to <i>EI.Eventxx.EventNumber</i> to acknowledge receipt of the event. When the number of events reaches its maximum value and rolls over, it rolls over to 1, not 0.	All values
FIFO[x].TimeStamp	LINT	The time that the event occurs	All positive values
FIFO[x].EventNumber	DINT	A running count of events which increment by one for each new event. Allows the controller to check for a new event by comparing this number to the last retrieved event. Write this <i>EventNumber</i> into the output data field <i>EventNumberAck</i> to acknowledge receipt of the event and display the next event. If the <i>EventNumber</i> reaches its maximum value, it rolls over to 1 instead of 0.	0...4,294,967,296
FIFO[x].Point	SINT	Indicates which of the 16 points that the event is recorded on	0...15
FIFO[x].Data	BOOL	Indicates the state of the input	<ul style="list-style-type: none"> 0 = Off 1 = On
FIFO[x].Fault	BOOL	Indicates that point data is inaccurate and cannot be trusted for use in the application. For more information, see Fault and Status Reporting on page 17 .	<ul style="list-style-type: none"> 0 = Good data 1 = Bad data causing fault
FIFO[x].Uncertain	BOOL	Indicates that point data could be inaccurate but the degree of inaccuracy is not known. For more information, see Fault and Status Reporting on page 17 .	<ul style="list-style-type: none"> 0 = Good data 1 = Uncertain data

Table 29 - Configurable Digital I/O Module Input Tags (Continued)

Name	Data Type	Definition	Valid Values
FIFO[x].CIPSyncValid	BOOL	Indicates whether the module has synchronized with a 1588 master during the event	<ul style="list-style-type: none"> 0 = Module is not synchronized 1 = Module is synchronized
FIFO[x].CIPSyncTimeout	BOOL	Indicates whether the module previously synchronized with a 1588 master but timed out during the event	<ul style="list-style-type: none"> 0 = A valid time master has not timed out 1 = A valid time master has timed out
EventsQueuedCount	DINT	Number of events currently queued up which are read	0...276
Schedule[x].State	SINT	Indicates the current state of the schedule	<ul style="list-style-type: none"> 0 = Inactive 1 = Active - Schedule is next to be applied to the output. 2 = Current - Schedule is not the next to be applied to the output. 3 = Expired - Schedule is applied. 4 = Discarded - Schedule is not enabled, or the requested schedule is late (received after its scheduled application time) and a more recent schedule is being applied to the output point. 5 = Late - Received schedule after the time to apply but is applied since there are no more current schedules received.
Schedule[x].ScheduleNumber	SINT	Echo of Schedule Number from the output image	-127...+127
LateScheduleCount	INT	Count of schedules that arrive late. The arrival time is after the scheduled time. The counter rolls over every 65,535 late updates.	0...65,535
LostScheduleCount	INT	Increments whenever the schedule sequence number in the output tag skips a value, which can indicate a lost schedule. The counter rolls over to 1 every 65,535 late updates.	0...65,535
Pwmxx.Active	BOOL	Indicates whether the output is generating PWM pulses.	<ul style="list-style-type: none"> 0 = The output is not generating pulses 1 = The output is generating pulses
Pwmxx.Error	BOOL	Indicates whether there is an error with generating the PWM pulse.	<ul style="list-style-type: none"> 0 = There is no error present 1 = One of the following errors is present: <ul style="list-style-type: none"> 0.Pwmxx.CycleTime < minimum cycle time 0.Pwmxx.CycleTime > maximum cycle time 0.Pwmxx.DutyCycle * cycle time < minimum pulse width (100% - 0.Pwmxx.DutyCycle) * cycle time < minimum pulse width

Output Tags

[Table 30](#) describes the available output tags ('O').

Table 30 - Configurable Digital I/O Module Output Tags

Name	Data Type	Definition	Valid Values
Counterxx.Reset	BOOL	When this bit transitions from 0 to 1, <i>I.Counterxx.Count</i> and <i>I.Counterxx.Rollover</i> is set to 0.	<ul style="list-style-type: none"> 0 = <i>I.Counterxx.Count</i> and <i>I.Counterxx.Rollover</i> are not set to 0 1 = <i>I.Counterxx.Count</i> and <i>I.Counterxx.Rollover</i> are set to 0
Counterxx.RolloverAck	BOOL	When this bit transitions from 0 to 1, <i>I.Counterxx.Rollover</i> is set to 0.	<ul style="list-style-type: none"> 0 = <i>I.Counterxx.Rollover</i> is not set to 0 1 = <i>I.Counterxx.Rollover</i> is set to 0
Counterxx.Preset	DINT	<ul style="list-style-type: none"> If <i>RolloverAtPreset</i> is set, the counter counts to the Preset value and then rolls over to zero. If <i>RolloverAtPreset</i> is not set, the counter sets the Done bit and continues counting up to maximum DINT value. If <i>C.Counterxx.RolloverAtPreset</i> = 1 Then if <i>I.Counterxx.Count</i> ≥ <i>O.Counterxx.Preset</i> <i>I.Counterxx.Count</i> = 0 Else <i>I.Counterxx.Done</i> = always 0. Set <i>I.Counterxx.Rollover</i> bit when <i>I.Counterxx.Count</i> transitions from <i>O.Counterxx.Preset</i> - 1 to 0. If <i>C.Counterxx.RolloverAtPreset</i> = 0 Then if <i>I.Counterxx.Count</i> ≥ <i>O.Counterxx.Preset</i> <i>I.Counterxx.Done</i> = 1 Else <i>I.Counterxx.Done</i> = 0. Set <i>I.Counterxx.Rollover</i> bit when <i>I.Counterxx.Count</i> transitions from 2,147,483,647 to 0. 	0...2,147,483,647
Ptxx.OutputEn	BOOL	Indicates whether to enable the Digital Output.	<ul style="list-style-type: none"> 0 = Do not enable the Digital Output 1 = Enable the Digital Output
Ptxx.Data	BOOL	Indicates the state of the output	<ul style="list-style-type: none"> 0 = Off 1 = On
Ptxx.ResetTimestamps	BOOL	Erases all recorded timestamps for the input point when it transitions from 0 to 1	<ul style="list-style-type: none"> 0 = Timestamps are not erased 1 = Timestamps are erased
Ptxx.TimestampOffOnNumberAck	INT	An Off to On timestamp identifier that the controller writes to indicate that the identified timestamp is seen and acted on. When Latching is enabled and the <i>Timestamp Number</i> that is received from the controller matches the most recent timestamp that is produced, the module is then allowed to produce a new timestamp.	All values
Ptxx.TimestampOnOffNumberAck	INT	An On to Off timestamp identifier that the controller writes to indicate that the identified timestamp is seen and acted on. When Latching is enabled and the <i>Timestamp Number</i> that is received from the controller matches the most recent timestamp that is produced, the module is then allowed to produce a new timestamp.	All values
FIFO.EventNumberAck	DINT	The controller writes the read <i>EventNumber</i> back to the transition buffers. All events with <i>EventNumbers</i> less than, or equal to, the <i>EventNumberAck</i> are acknowledged.	All values
FIFO.PointToRetrieve	SINT	When <i>RetrieveByPoint</i> is set, this determines the point that requests events to be returned. Allows you to query events in the sequence that they happen by point instead of the overall sequence the events that occur.	0...15
FIFO.ResetEvents	BOOL	When transitioned from 0 to 1, this erases all recorded timestamped events	<ul style="list-style-type: none"> 0 = No action 1 = Clears events on transition
FIFO.RetrieveByPoint	BOOL	Changes the retrieval mechanism from sequential (when 0) to event retrieval per point basis according to the value set in the <i>PointToRetrieve</i> field	<ul style="list-style-type: none"> 0 = Retrieve sequentially 1 = Retrieve events on a per point basis
TimeBase	LINT	Indicates the TimeBase for all schedule times in a scheduled output consumed assembly. The <i>TimeBase</i> + <i>Schedule[n].TimeOffset</i> determines the time for the schedule. Base/Offset scheme that is used to fit enough schedules into the assembly.	Any positive value
Ptxx.ScheduleEn	BOOL	Specifies the use of normal output data or scheduled data	<ul style="list-style-type: none"> 0 = Normal output data 1 = Scheduled data
Schedule[x].ID	SINT	Indicates which schedule is to be loaded with attached data	<ul style="list-style-type: none"> 1...32 = Valid schedule 0, 129...255 = No schedule

Table 30 - Configurable Digital I/O Module Output Tags (Continued)

Name	Data Type	Definition	Valid Values
Schedule[x].SequenceNumber	SINT	Value must be changed for a new schedule to be recognized.	-127...+127
Schedule[x].OutputPointSelect	SINT	Selects the output point that this schedule applies to. 0xFF means no output point selected.	0...15
Schedule[x].Data	BOOL	Output data to be applied at the time that is specified in the schedule	<ul style="list-style-type: none"> 0 = Off 1 = On
Schedule[x].TimeOffset	DINT	Offset to add to <i>TimeBase</i> to determine absolute Time to apply Data to physical Output. Allows for a range of approximately ± 2 s from the base <i>TimeBase</i> .	All values
Pwmxx.CycleTime	REAL	Indicates the period in seconds of one pulse cycle.	0 μ s...30 s
Pwmxx.DutyCycle	REAL	Indicates in percentage of the pulse cycle time when output is in the active state.	0...100%
Pwmxx.CycleCountLimit	DINT	Determines the number of pulse cycles to be generated when there is a rising edge in the data. Only applicable when C.Pwmxx.CycleCountEn = 1.	0...2,147,483,647

Event Input Tags

[Table 31](#) describes the available event input tags ('E').

Table 31 - Configurable Digital I/O Module Event Input Tags

Name	Data Type	Definition	Valid Values
RunMode	BOOL	Indicates the operating state of the input	<ul style="list-style-type: none"> 0 = Idle 1 = Run mode
ConnectionFaulted	BOOL	Indicates if a connection is running. The module sets this tag to 0 when connected. If the module is not connected, it sets this tag to 1.	<ul style="list-style-type: none"> 0 = Connection running 1 = Connection not running
DiagnosticActive	BOOL	Indicates if any diagnostics are active or if the prognostics threshold is reached	<ul style="list-style-type: none"> 0 = No diagnostics active 1 = One or more diagnostics are active or the prognostics threshold is reached
DiagnosticSequenceCount	SINT	Increments each time that a distinct diagnostic condition is detected, and each time a distinct diagnostic condition transitions from detected to not detected. Resets to zero on power cycle. Wraps from 255 (-1) to 1, skipping zero.	-128...+127 The value of 0 is skipped except during module powerup.
Eventxx.Fault	BOOL	Detects whether the signal is good data. The fault is set to 1 by the originator when the connection is lost.	<ul style="list-style-type: none"> 0 = Good 1 = Bad, causing fault
Eventxx.Uncertain	BOOL	Indicates that the point data can be inaccurate but the degree of inaccuracy is not known. For more information, see Fault and Status Reporting on page 17 .	<ul style="list-style-type: none"> 0 = Good data 1 = Uncertain data <p>If the tag is set to 1, you must troubleshoot the module to correct the cause of the inaccuracy. IMPORTANT: Once the condition that causes the tag to change to 1 is removed, the tag automatically resets to 0.</p>
Eventxx.EventDropped	BOOL	Indicates when an event has been discarded because events are occurring faster than they are acknowledged	<ul style="list-style-type: none"> 0 = An event status has not been dropped 1 = An event status has been dropped
Eventxx.EventRising	BOOL	Indicates whether an event triggered when an input transition results in an event pattern being matched	<ul style="list-style-type: none"> 0 = No Rising event has occurred 1 = Rising event has occurred
Eventxx.EventFalling	BOOL	Indicates whether an event triggered when an input transition resulted in an event pattern no longer matching	<ul style="list-style-type: none"> 0 = No Falling event has occurred 1 = Falling event has occurred
Eventxx.CIPSyncValid	BOOL	Indicates whether the module is synced with a 1588 master	<ul style="list-style-type: none"> 0 = Module not synchronized 1 = Module synchronized
Eventxx.CIPSyncTimeout	BOOL	Indicates that the module was once synced with a 1588 master, but is not now due to a timeout	<ul style="list-style-type: none"> 0 = A valid time master has not timed out. 1 = A valid time master was detected on the backplane, but the time master has timed out. The module is using its local clock and can be drifting away from the last known time master.
Eventxx.EventsPending	SINT	The number of events currently queued in the modules. A value greater than 0 indicates that the controller is not keeping up with the rate of events.	All positive values

Table 31 - Configurable Digital I/O Module Event Input Tags (Continued)

Name	Data Type	Definition	Valid Values
Eventxx.EventNumber	DINT	Running count of events, which increments by one each new time event. The originator sets <i>EO.Eventxx.EventNumberAck</i> to <i>EI.Eventxx.EventNumber</i> to acknowledge receipt of the event. When the number of events reaches its maximum value and rolls over, it rolls over to 1, not 0.	All values
Eventxx.EventTimestamp	LINT	The time the event occurred	All positive values
Eventxx.PtxxData	BOOL	When set, indicates the corresponding data value (rising or falling depending on configuration) triggers the event	<ul style="list-style-type: none"> 0 = Corresponding data value did not trigger the event 1 = Corresponding data value triggered the event
Eventxx.CounterxxDone	BOOL	When set, indicates the corresponding counter Done bit (rising or falling depending on configuration) triggers the event	<ul style="list-style-type: none"> 0 = Corresponding counter Done bit did not trigger the event 1 = Corresponding counter Done bit triggered the event
Eventxx.PtxxFault	BOOL	Indicates that point data is inaccurate and cannot be trusted for use in the application. For more information, see Fault and Status Reporting on page 17 .	<ul style="list-style-type: none"> 0 = Good 1 = Bad, causing fault <p>If the tag is set to 1, you must troubleshoot the module to correct the cause of the inaccuracy. IMPORTANT: Once the condition that causes the tag to change to 1 is removed, the tag automatically resets to 0.</p>
Eventxx.CounterxxFault	BOOL	When set, indicates that the corresponding counter has a fault to indicate when the event occurs	<ul style="list-style-type: none"> 0 = Corresponding counter does not have a fault to indicate when the event occurs. 1 = Corresponding counter has a fault to indicate when the event occurs.
Ptxx.NewDataAck	SINT	Allows <i>I.NewData</i> bits and <i>I.Timestamp</i> data updates in the Input tag to function as intended. <i>I.NewData</i> bits are set and <i>I.Timestamp</i> data updates when a transition occurs and clear only after they are acknowledged via the <i>O.NewDataAck</i> bit. Typically, the following events occur: <ul style="list-style-type: none"> An event occurs on an input. The module sets the <i>I.NewData</i> bit and <i>I.Timestamp</i> data for the input where the event occurred. The controller records the new data. The controller acknowledges the new data with a transition from 0 to 1 on the corresponding <i>O.NewDataAck</i> bit. The <i>I.NewData</i> bit and <i>I.Timestamp</i> data clear. When another event occurs on the input, the sequence begins at the top bullet in this list. The controller must cause a 0 to 1 transition in this bit to acknowledge new data for an input; in other words, if the <i>NewDataAck</i> bit is 0 when new data is received, the controller must change this bit to 1 to acknowledge the data. If <i>NewDataAck</i> bit is 1 when new data is received, the controller must change this bit to 0 and then at least one RPI later to 1 to acknowledge the new data.	<ul style="list-style-type: none"> 0 = No action 1 = Acknowledge new events of the point during transition

Event Output Tags

[Table 32](#) describes the available event output tags ('EO').

Table 32 - Configurable Digital I/O Module Event Output Tags

Name	Data Type	Definition	Valid Values
Eventxx.En	BOOL	When set, the corresponding event trigger definition is active and events are triggered when conditions match the definition	<ul style="list-style-type: none"> 0 = Event trigger definition is not active and events are not triggered when conditions match the definition 1 = Event trigger definition is active and events are triggered when conditions match the definition

Table 32 - Configurable Digital I/O Module Event Output Tags (Continued)

Name	Data Type	Definition	Valid Values
Eventxx.EventRisingEn	BOOL	Triggers an event each time a condition change results in conditions that match the event trigger definition	When <i>EO.Eventxx.IndependentConditionTriggerEn</i> = 0 Trigger event (EventRisingEn, EventFallingEn):
Eventxx.EventFallingEn	BOOL		<ul style="list-style-type: none"> • Disable (0, 0) • On input transition to match pattern (1, 0) • On input transition to not match pattern (0, 1) • On input transition to match or not match pattern (1, 1)
Eventxx.LatchEn	BOOL	When set, events are latched until acknowledged. A new event is lost if the previous event has not been acknowledged. When not set, new events overwrite old events.	<ul style="list-style-type: none"> • 0 = Event is not latched • 1 = Event is latched
Eventxx.ResetEvent	BOOL	A transition from 0 to 1 resets all events and clears the event queue on the point	0 or 1
Eventxx.IndependentConditionTriggerEn	BOOL	Determines whether an input state change or a pattern of input state changes triggers an event	<ul style="list-style-type: none"> • 0 = Event is triggered when all participating inputs in the event trigger achieve their configured values • 1 = Event is triggered when any participating input in the event trigger achieves their configured value
Eventxx.EventNumberAck	DINT	The controller writes back <i>EI.Eventxx.EventNumber</i> into <i>EO.Eventxx.EventNumberAck</i> to indicate receipt of the event	All values
Eventxx.PtxxDataSelect	BOOL	Determines whether the input participates in the event trigger	<ul style="list-style-type: none"> • 0 = Does not participate in event trigger • 1 = Participates in event trigger
Eventxx.CounterxxSelect	BOOL	Determines whether the counter participates in the event trigger	<ul style="list-style-type: none"> • 0 = Does not participate in event trigger • 1 = Participates in event trigger
Eventxx.PtxxDataValue	BOOL	Determines the state of the input that triggers the event	<ul style="list-style-type: none"> • 0 = Off • 1 = On
Eventxx.CounterxxValue	BOOL	Determines the state of the counter that triggers the event	<ul style="list-style-type: none"> • 0 = Not done • 1 = Done

Status Tags

[Table 33](#) describes the available status tags ('S').

Table 33 - Configurable Digital I/O Module Status Tags

Name	Data Type	Definition	Valid Values
RunMode	BOOL	Indicates the operating state of the input	<ul style="list-style-type: none"> • 0 = Idle • 1 = Run mode
ConnectionFaulted	BOOL	Indicates if a connection is running. The module sets this tag to 0 when connected. If the module is not connected, it sets this tag to 1.	<ul style="list-style-type: none"> • 0 = Connection running • 1 = Connection not running
DiagnosticActive	BOOL	Indicates if any diagnostics are active or if the prognostics threshold is reached.	<ul style="list-style-type: none"> • 0 = No diagnostics active • 1 = One or more diagnostics are active or the prognostics threshold is reached
CIPSyncValid	BOOL	Indicates if the module is synchronized with a 1588 master	<ul style="list-style-type: none"> • 0 = Module not synchronized • 1 = Module synchronized
CIPSyncTimeout	BOOL	Indicates if the module was previously synchronized with a 1588 master but is now timed out	<ul style="list-style-type: none"> • 0 = A valid time master has not timed out • 1 = A valid time master has timed out
DiagnosticSequenceCount	SINT	Increments for each time a distinct diagnostic condition is detected, and when a distinct diagnostic condition transitions from detected to not detected. Sets to zero by product reset or power cycle. Wraps from 255 (-1) to 1 skipping zero.	-128...+127 The value of 0 is skipped except during module powerup.

Table 33 - Configurable Digital I/O Module Status Tags (Continued)

Name	Data Type	Definition	Valid Values
Portx.Fault	BOOL	Indicates that port data is inaccurate and cannot be trusted for use in the application. For more information, see Fault and Status Reporting on page 17 .	<ul style="list-style-type: none"> 0 = Good 1 = Bad, causing fault If the tag is set to 1, you must troubleshoot the module to correct the cause of the inaccuracy. IMPORTANT: Once the condition that causes the tag to change to 1 is removed, the tag automatically resets to 0.
Portx.Uncertain	BOOL	Indicates that the port data can be inaccurate but the degree of inaccuracy is not known. For more information, see Fault and Status Reporting on page 17 .	<ul style="list-style-type: none"> 0 = Good data 1 = Uncertain data If the tag is set to 1, you must troubleshoot the module to correct the cause of the inaccuracy. IMPORTANT: Once the condition that causes the tag to change to 1 is removed, the tag automatically resets to 0.
Portx.Connected	BOOL	Indicates whether the Ethernet port is active	<ul style="list-style-type: none"> 0 = Ethernet port is inactive 1 = Ethernet port is active
Portx.FullDuplex	BOOL	Indicates whether the Ethernet port is running full-duplex mode or half-duplex mode when connected	<ul style="list-style-type: none"> 0 = Ethernet port is running in half-duplex mode 1 = Ethernet port is running in full-duplex mode
Portx.AutonegotiationStatus	SINT	Indicates the status of link auto-negotiation	<ul style="list-style-type: none"> 0 = Auto-negotiation in progress. 1 = Auto-negotiation and speed detection failed. Using default values for speed and duplex. Default values are product-dependent; recommended defaults are 10 Mbps and half-duplex. 2 = Auto negotiation failed, but detected speed. Duplex was defaulted. Default value is product-dependent; recommended default is half-duplex mode. 3 = Successfully negotiated speed and duplex mode 4 = Auto-negotiation not attempted. Forced speed and duplex mode.
Portx.Speed	INT	Indicates the actual port speed in Mbps. A value of 0 means that the speed is undetermined.	<ul style="list-style-type: none"> 10 100
TCPConnections	INT	Total number of active TCP connections	All positive values
CIPConnections	INT	Total number of active CIP connections	All positive values
CIPLostPackets	DINT	Total number of lost CIP packets	All positive values
CIPTimeouts	DINT	Total number of connection timeouts that have occurred	All positive values
HMIPacketRate	DINT	The packet rate between the module and HMI	All positive values
IOPacketRate	DINT	The packet rate to and from the module	All positive values
EthernetErrors	DINT	Total number of Ethernet errors	All positive values
CPUUtilization	INT	Total CPU load	0...100%
DLRNetworkState	SINT	The status of the network	<ul style="list-style-type: none"> 0 = Normal 1 = Ring Fault 2 = Unexpected Loop Detected 3 = Partial Network Fault 4 = Rapid Fault/Restore Cycle
DLRSupervisorState	SINT	The status of the network supervisor	<ul style="list-style-type: none"> 0 = Device is functioning as a backup 1 = Device is functioning as the active ring supervisor 2 = Device is functioning as a normal ring node 3 = Device is operating in a non-DLR topology 4 = Device cannot support the current ring parameters (Beacon Interval and Beacon Timeout)
DLREnabled	BOOL	Indicates if DRL network redundancy mode is enabled	<ul style="list-style-type: none"> 0 = DLR is not enabled 1 = DLR is enabled
LocalClockOffset	LINT	The offset in nanoseconds from the local clock to the system time. Use this value to detect steps in time. This value updates when a PTP update is received.	All values
LocalClockOffsetTimestamp	LINT	The most recent time the <i>LocalClockOffset</i> was sampled. The initial value is zero and the first timestamp occurs when the module synchronizes with the master clock.	N/A
GrandMasterClockID	SINT[8]	The EUI-64 Identity of the CIP Sync Grandmaster clock that the module is synced to	All values

Diagnostic Assembly

Create User-defined Diagnostic Assembly Types

You can use the Studio 5000 Logix Designer application to create user-defined Diagnostic Assembly types for the ArmorBlock 5000 configurable digital I/O module.

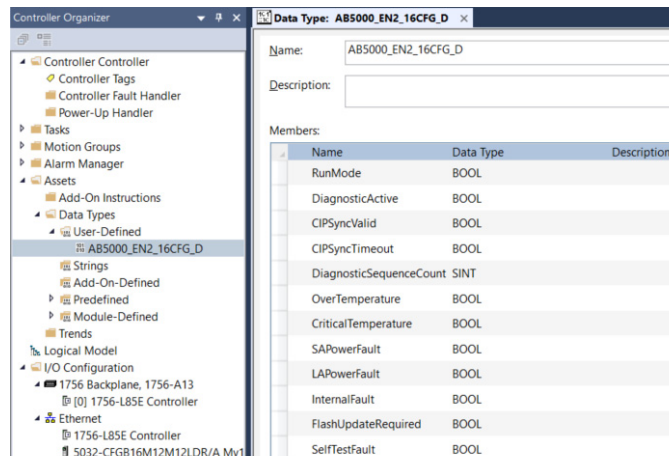

IMPORTANT The members that are indicated in the tables are arranged according to the Data Alignment Rules of controllers. Strictly follow the Data Type and sequence of the members that are indicated in the tables of this Appendix. Data misalignment after executing 'Get Attribute Single' Message (MSG) instruction can occur if the Data Type and sequence are not followed.

Diagnostic Assemblies

- Diagnostic 2 Port Ethernet Assembly
 - Instance ID = 0x8007 (32,775)
 - Size = 104 bytes

Follow the information in [Table 34](#) to add each member.

Table 34 - Diagnostic Assembly Instance 32775

Name	Data Type	Byte	Valid Values
RunMode	BOOL	1	0 = Idle 1 = Run mode
Reserved1	BOOL		—
DiagnosticActive	BOOL		0 = No diagnostics active 1 = One or more diagnostics are active or the prognostics threshold is reached
CIPSyncValid	BOOL		0 = Module not synchronized 1 = Module synchronized
CIPSyncTimeout	BOOL		0 = A valid time master has not timed out 1 = A valid time master has timed out
Reserved2...Reserved4	BOOL		—
DiagnosticSequenceCount	SINT	1	-128...+127 The value of 0 is skipped except during module power-up.

Table 34 - Diagnostic Assembly Instance 32775 (Continued)

Name	Data Type	Byte	Valid Values
OverTemperature	BOOL	2	0 = Module temperature not over operating limits 1 = Module temperature over operating limits
CriticalTemperature	BOOL		0 = Module not above critical temperature limit for proper operation 1 = Module above critical temperature limit for proper operation and may shut down without further warning
Reserved5...Reserved6	BOOL		–
SAPowerFault	BOOL		0 = No fault on SA power exists 1 = Fault on SA power exists
LAPowerFault	BOOL		0 = No fault on LA power exists 1 = Fault on LA power exists
Reserved7	BOOL		–
InternalFault	BOOL		0 = No internal fault detected 1 = One or more internal diagnostics indicate an internal issue in the module. Fault is latched until the point or device is reset.
Reserved8...Reserved11	BOOL		–
FlashUpdateRequired	BOOL		0 = Flash update not required 1 = Module has no application firmware
SelfTestFault	BOOL		0 = Module initialization code did not detect an error 1 = Module initialization code detected an error
Reserved12...Reserved13	BOOL		–
Reserved14...Reserved21	BOOL		–
DLREnabled	BOOL		2
Reserved22...Reserved23	BOOL	–	
DLRNetworkState	SINT	1	The status of the network
DLRSupervisorState	SINT	1	The status of the network supervisor
LocalClockOffset	LINT	8	The offset in nanoseconds from the local clock to the system time. Use this value to detect steps in time. This value updates when a PTP update is received.
LocalClockOffsetTimestamp	LINT	8	The most recent time the <i>LocalClockOffset</i> is sampled. The initial value is zero and the first timestamp occurs when the module synchronizes with the master clock.
GrandMasterClockID	SINT[8]	8	The EUI-64 Identity of the CIP Sync Grandmaster clock that the module is synced to
SAPowerFaultTimestamp	LINT	8	The most recent time an SA power fault occurred
LAPowerFaultTimestamp	LINT	8	The most recent time an LA power fault occurred
OverTemperatureTimestamp	LINT	8	The most recent time the module reached a higher temperature than its operating limits
CriticalTemperatureTimestamp	LINT	8	The most recent time the module temperature transitioned above the Critical Temperature
InternalFaultTimestamp	LINT	8	The most recent time an internal fault condition occurred
AB:Ethernet_Port_Channel:D:0 Port1	User-defined	16	User-defined data type for AB:Ethernet_Port_Channel:D:0, see Table 40 .
AB:Ethernet_Port_Channel:D:0 Port2	User-defined	16	

2. Diagnostic Configurable IO Assembly A

- Instance ID = 0x800E (32,782)
- Size = 200 bytes

Follow the information in [Table 35](#) to add each member.

Table 35 - Diagnostic Assembly Instance 32782

Name	Data Type	Byte	Valid Values
ChannelMode00	SINT	1	The operating mode of the point
ChannelMode01	SINT	1	The operating mode of the point
ChannelMode02	SINT	1	The operating mode of the point
ChannelMode03	SINT	1	The operating mode of the point
Reserved1	DINT	4	–
AB:5000_CFG_Channel:D:0 Ch00	User-defined	48	User-defined data type for AB:5000_CFG_Channel:D:0, see Table 41 .
AB:5000_CFG_Channel:D:0 Ch01	User-defined	48	
AB:5000_CFG_Channel:D:0 Ch02	User-defined	48	
AB:5000_CFG_Channel:D:0 Ch03	User-defined	48	

3. Diagnostic Configurable IO Assembly B

- Instance ID = 0x8010 (32,784)
- Size = 200 bytes

Follow the information in [Table 36](#) to add each member.

Table 36 - Diagnostic Assembly Instance 32784

Name	Data Type	Byte	Valid Values
ChannelMode04	SINT	1	The operating mode of the point
ChannelMode05	SINT	1	The operating mode of the point
ChannelMode06	SINT	1	The operating mode of the point
ChannelMode07	SINT	1	The operating mode of the point
Reserved1	DINT	4	–
AB:5000_CFG_Channel:D:0 Ch04	User-defined	48	User-defined data type for AB:5000_CFG_Channel:D:0, see Table 41 .
AB:5000_CFG_Channel:D:0 Ch05	User-defined	48	
AB:5000_CFG_Channel:D:0 Ch06	User-defined	48	
AB:5000_CFG_Channel:D:0 Ch07	User-defined	48	

4. Diagnostic Configurable IO Assembly C

- Instance ID = 0x8011 (32,785)
- Size = 200 bytes

Follow the information in [Table 37](#) to add each member.

Table 37 - Diagnostic Assembly Instance 32785

Name	Data Type	Byte	Valid Values
ChannelMode08	SINT	1	The operating mode of the point
ChannelMode09	SINT	1	The operating mode of the point
ChannelMode10	SINT	1	The operating mode of the point
ChannelMode11	SINT	1	The operating mode of the point
Reserved1	DINT	4	–
AB:5000_CFG_Channel:D:0 Ch08	User-defined	48	User-defined type for AB:5000_CFG_Channel:D:0, see Table 41 .
AB:5000_CFG_Channel:D:0 Ch09	User-defined	48	
AB:5000_CFG_Channel:D:0 Ch10	User-defined	48	
AB:5000_CFG_Channel:D:0 Ch11	User-defined	48	

5. Diagnostic Configurable IO Assembly D

- Instance ID = 0x8012 (32,786)
- Size = 200 bytes

Follow the information in [Table 38](#) to add each member.

Table 38 - Diagnostic Assembly Instance 32786

Name	Data Type	Byte	Valid Values
ChannelMode12	SINT	1	The operating mode of the point
ChannelMode13	SINT	1	The operating mode of the point
ChannelMode14	SINT	1	The operating mode of the point
ChannelMode15	SINT	1	The operating mode of the point
Reserved1	DINT	4	–
AB:5000_CFG_Channel:D:0 Ch12	User-defined	48	User-defined type for AB:5000_CFG_Channel:D:0, see Table 41 .
AB:5000_CFG_Channel:D:0 Ch13	User-defined	48	
AB:5000_CFG_Channel:D:0 Ch14	User-defined	48	
AB:5000_CFG_Channel:D:0 Ch15	User-defined	48	

6. Diagnostic Counters Ethernet Adapter Assembly

- Instance ID = 0x303 (771)
- Size = 28 bytes

Follow the information in [Table 39](#) to add each member.

Table 39 - Diagnostic Assembly Instance 771

Name	Data Type	Byte	Valid Values
RunMode	BOOL	1	0 = Idle 1 = Run mode
Reserved1	BOOL		–
DiagnosticActive	BOOL		0 = No diagnostics active 1 = One or more diagnostics are active or the prognostics threshold is reached
Reserved2...Reserved6	BOOL		–
DiagnosticSequenceCount	SINT	1	-128...+127 The value of 0 is skipped except during module power-up.
TCPConnections	INT	2	Total number of active TCP connections
CIPConnections	INT	2	Total number of active CIP connections
CIPLostPackets	DINT	4	Total number of lost CIP packets
CIPTimeouts	DINT	4	Total number of connection timeouts that have occurred
HMIPacketRate	DINT	4	The packet rate between the module and HMI
IOPacketRate	DINT	4	The packet rate to and from the module
EthernetErrors	DINT	4	Total number of Ethernet errors
CPUUtilization	INT	2	Total CPU load

Diagnostic Points

The following data types are retrieved as part of the Diagnostic Assembly Instance.

1. Diagnostic Ethernet Channel
 - Data Type = AB:Ethernet_Port_Channel:D:0
 - Size: 16 bytes

Follow the information in [Table 40](#) to add each member.

Table 40 - Structure for AB:Ethernet_Port_Channel:D:0

Name	Data Type	Byte	Valid Values
Reserved1	BOOL	1	–
Fault	BOOL		0 = No fault exists 1 = Fault exists
Uncertain	BOOL		0 = Good data 1 = Uncertain data If the tag is set to 1, you must troubleshoot the module to correct the cause of the inaccuracy. IMPORTANT: Once the condition that causes the tag to change to 1 is removed, the tag automatically resets to 0.
Connected	BOOL		0 = Ethernet port is inactive 1 = Ethernet port is active
FullDuplex	BOOL		0 = Ethernet port is running in half-duplex mode 1 = Ethernet port is running in full-duplex mode
Reserved2...Reserved4	BOOL		–
AutonegotiationStatus	SINT		1

Table 40 - Structure for AB:Ethernet_Port_Channel:D:0 (Continued)

Name	Data Type	Byte	Valid Values
Speed	INT	2	<ul style="list-style-type: none"> 10 Mbps 100 Mbps
Reserved5	DINT	4	–
DisconnectedTimestamp	LINT	8	The most recent time the port is disconnected

2. Diagnostic Configurable IO Channel

- Data Type = AB:5000_CFG_Channel:D:0
- Size = 48 bytes

Follow the information in [Table 41](#) to add each member.

Table 41 - Structure for AB:5000_CFG_Channel:D:0

Name	Data Type	Byte	Valid Values
Reserved1	BOOL	2	–
Fault	BOOL		<ul style="list-style-type: none"> 0 = No fault exists 1 = Fault exists
Uncertain	BOOL		<ul style="list-style-type: none"> 0 = Good data 1 = Uncertain data <p>If the tag is set to 1, you must troubleshoot the module to correct the cause of the inaccuracy. IMPORTANT: Once the condition that causes the tag to change to 1 is removed, the tag automatically resets to 0.</p>
Reserved2	BOOL		–
ShortCircuit	BOOL		<ul style="list-style-type: none"> 0 = No short circuit or overcurrent condition exists 1 = Short circuit or overcurrent condition exists
Reserved3...Reserved6	BOOL		–
SAPowerFault	BOOL		0 = No fault on SA power exists 1 = Fault on SA power exists
Reserved7	BOOL		–
MSASSVShortCircuit	BOOL		MSA SSV short circuit or overcurrent <ul style="list-style-type: none"> 0 = No SA power short circuit or overcurrent 1 = SA power short circuit or overcurrent exists
LAPowerFault	BOOL		<ul style="list-style-type: none"> 0 = No fault on LA power exists 1 = Fault on LA power exists
Reserved8	BOOL		–
LASSVShortCircuit	BOOL		LA SSV short circuit or overcurrent <ul style="list-style-type: none"> 0 = No LA power short circuit or overcurrent 1 = LA power short circuit or overcurrent exists
Reserved9	BOOL		–
Reserved10...Reserved11	SINT	1	–
Reserved12	DINT	4	–
Reserved13	LINT	8	–
ShortCircuitTimestamp	LINT	8	The most recent time a short circuit occurred
SAPowerFaultTimestamp	LINT	8	The most recent time a fault on SA power occurred
MSASSVShortCircuitTimestamp	LINT	8	The time when an MSA SSV short circuit condition most recently transitioned from false to true. This is a group fault but notified per point basis. Short Circuit in one point affects all points that are configured as input on MSA side.
LAPowerFaultTimestamp	LINT	8	The most recent time a fault on LA power occurred
LASSVShortCircuitTimestamp	LINT	8	The time when an LA SSV short circuit condition most recently transitioned from false to true. This is a group fault but notified per point basis. Short Circuit in one point affects all points that are configured as input on LA side.

Create Message Type User Tags

Create message type user tags for requests and associated response user tags for each of the new user-defined diagnostic assembly types.

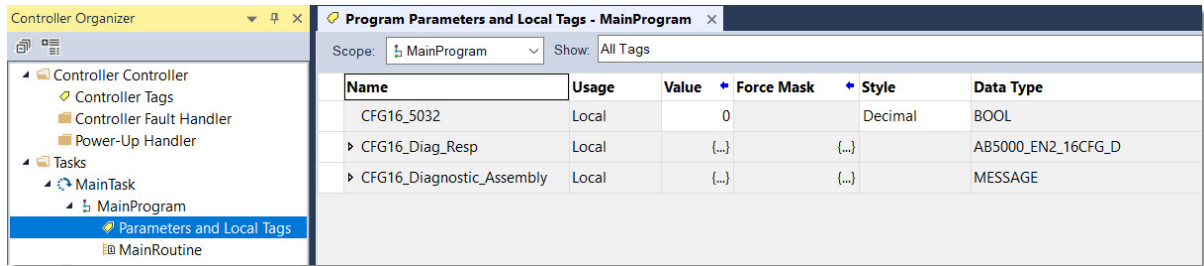

From the Controller Organizer pane, expand Tasks > Main Task > MainProgram.

1. Create message type user tags for each request.
2. Create associated response user tags for each new user-defined diagnostic assembly type.
3. Add the user tags to your ladder program.



4. Expand the message tag to open the message configuration dialog.
5. On the Configuration tab, enter the following information:
 - Service Type = Get Attribute Single
 - Class = 4
 - Instance =
 - 32775 (0x8007) Diagnostic 2 Port Ethernet Assembly
 - 0x800E (32,782) Diagnostic Configurable IO Assembly A
 - 0x8010 (32,784) Diagnostic Configurable IO Assembly B
 - 0x8011 (32,785) Diagnostic Configurable IO Assembly C
 - 0x8012 (32,786) Diagnostic Configurable IO Assembly D
 - 771 (0x303) Diagnostic Counters Ethernet Adapter Assembly
 - Attribute = 3
 - Destination Element = User-defined type suitable for the instance entered
6. On the Communication tab, select the path to the module that you wish to send the message to.
7. Select OK.
8. Download the project and set to Run mode.

Note: For 8-point mode Diagnostic IO Assembly, only even points are applicable.

You can monitor the user-defined tag values from the Program Parameters and Local Tags window, under the MainProgram task in the Controller Organizer pane.

The screenshot shows the 'Program Parameters and Local Tags - MainProgram' window. The left pane shows the Controller Organizer tree with 'MainProgram' selected. The main pane displays a table of tags. The 'CFG16_Diagnostic_Assembly.Flags' tag is highlighted with a black border.

Name	Usage	Value	Force Mask	Style	Data Type
CFG16_Diag_Resp	Local	{...}	{...}		AB5000_EN2_16CFG_D
CFG16_Diag_Resp.RunMode		0		Decimal	BOOL
CFG16_Diag_Resp.DiagnosticActive		0		Decimal	BOOL
CFG16_Diag_Resp.CIPSyncValid		0		Decimal	BOOL
CFG16_Diag_Resp.CIPSyncTimeout		0		Decimal	BOOL
CFG16_Diag_Resp.DiagnosticSequenceCount		0		Decimal	SINT
CFG16_Diag_Resp.OverTemperature		0		Decimal	BOOL
CFG16_Diag_Resp.CriticalTemperature		0		Decimal	BOOL
CFG16_Diag_Resp.SAPowerFault		0		Decimal	BOOL
CFG16_Diag_Resp.LAPowerFault		0		Decimal	BOOL
CFG16_Diag_Resp.InternalFault		0		Decimal	BOOL
CFG16_Diag_Resp.FlashUpdateRequired		0		Decimal	BOOL
CFG16_Diag_Resp.SelfTestFault		0		Decimal	BOOL
CFG16_Diagnostic_Assembly	Local	{...}	{...}		MESSAGE
CFG16_Diagnostic_Assembly.Flags		16#0200		Hex	INT
CFG16_Diagnostic_Assembly.EW		0		Decimal	BOOL
CFG16_Diagnostic_Assembly.ER		0		Decimal	BOOL
CFG16_Diagnostic_Assembly.DN		0		Decimal	BOOL
CFG16_Diagnostic_Assembly.ST		0		Decimal	BOOL

Notes:

Secure Web Server

The ArmorBlock 5000 16-channel configurable digital I/O module allows you to access extensive internal and network diagnostics, view and modify its configuration settings using its secure web server interface.

To view the web server interface, enter the IP address of the configurable digital I/O module into your browser, preceded by "https://".

For example, <https://192.168.1.125>

IMPORTANT Make sure that your LAN and TCP/IP settings are configured to access the subnet on which your ArmorBlock 5000 16-channel configurable digital I/O module communicates.

We recommend that you only use a secure network environment as it retains default settings.

Browser Requirements

In order to access the ArmorBlock 5000 16-channel configurable digital I/O module web server pages you need to use the latest versions of the following browsers:

- Microsoft Edge® version 116 or later
- Google Chrome® version 116 or later
- Mozilla Firefox® version 109 or later

To access data view web server pages, your browser requires JavaScript support.

Enable or Disable the Web Server

The web server functionality is enabled by default and comes with a default username and password.

IMPORTANT You must change the default password before establishing an initial I/O connection in order to access configuration pages.

If you do not change the default password before establishing an initial I/O connection, the web server is disabled and remains in read-only state even when enabled. To access the configuration pages you need to perform a factory reset and change the default password before establishing an initial I/O connection.

Enable or disable the functionality in Studio 5000 Logix Designer.

You can also disable the web server using the web server configuration pages.

Access the Web Server Home Page

The first time that you enter the IP address of the module into your web browser, a self-signed SSL Certificate security warning appears. This occurs due to a self-signed certificate used to establish a secure HTTP connection.

Figure 19 - Example of Self-signed SSL Certificate Warning

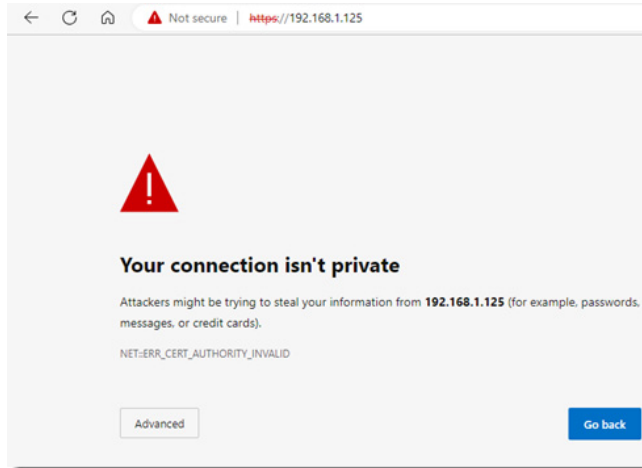

To proceed, you need to acknowledge the warning. The steps to acknowledge the warning vary depending on the browser that you use. Follow the instructions on the warning page. Once you have acknowledged the warning, the web server Home page displays.

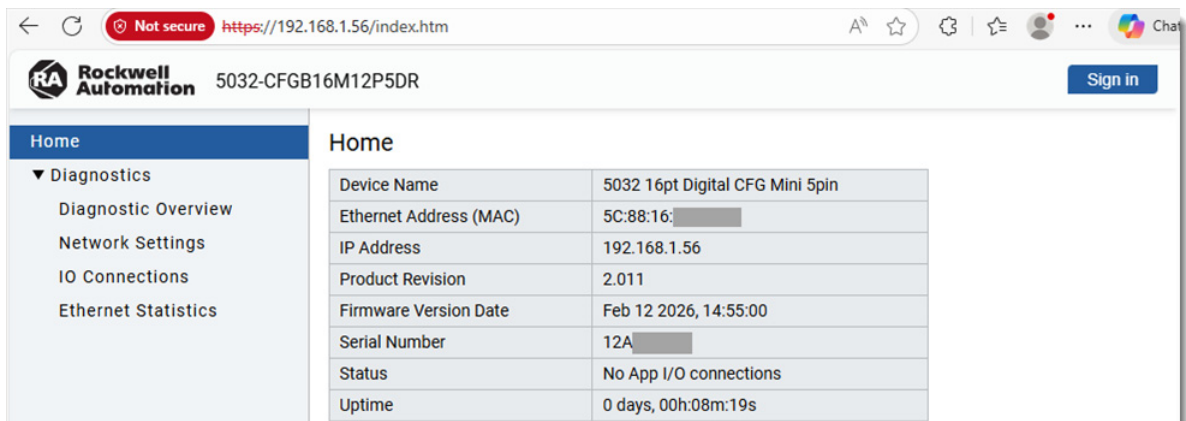

Without logging in, you can view the Diagnostics information of the module. If you need to view or modify the Configuration options, you must authenticate with your credentials.

Log in to the Web Server

Many of the ArmorBlock 5000 16-channel configurable digital I/O module features require you to log on with appropriate access. If you need to view or modify the Configuration options, you must log in with your username and password.

Select Log In on the top right of the page to launch the login dialog.



Mandatory First-time Password Change

You must change the default password after you log in to the web server for a module that is in the out-of-box state, or when the module has been reset to factory default.

The first time you access the web server, the Change Password dialog appears as shown in [Figure 20](#).

Figure 20 - Change Password Example

Rockwell Automation

Change Password

Username:
admin

The password is the factory default; please choose a new password

Old Password:

The password must be at least six characters and cannot contain spaces.

New Password:

Re-enter New Password:

Cancel Set Password

- Factory default username: "admin"
- Factory default password: "password"

The newly set password must adhere to the following criteria:

- Does not contain spaces
- Does not match the default password
- Password length must contain 8...64 characters
- Username and password are case sensitive

IMPORTANT

Passwords that you create in one major firmware revision are not compatible with another major firmware revision.

If you update the module with another major firmware revision, you must reset the module to factory default to log in. For information on how to reset your module to factory default, see [Reset Module to Factory Default on page 79](#).

Maximum Limit of Unsuccessful Login Attempts

You are allowed up to three unsuccessful attempts to log in to the web server.

The error message "Incorrect username and/or password!" displays for the first three unsuccessful attempts. On subsequent unsuccessful attempts, the message "Incorrect Credentials. Login Failed..!" error message displays and you are locked out of the web server for 30 seconds.

First three unsuccessful login attempts

The screenshot shows a login form with a red error message at the top: "Incorrect username and/or password!". Below the message, the form is titled "Log In" and contains two input fields: "Username" and "Password". The "Password" field is masked with asterisks. At the bottom of the form, there are two buttons: "Cancel" on the left and "Log In" on the right.

Subsequent unsuccessful login attempts

The screenshot shows a login form with a red error message at the top: "Incorrect Credentials. Login Failed..!". Below the message, the form is titled "Log In" and contains two input fields: "Username" and "Password". The "Password" field is masked with asterisks. At the bottom of the form, there are two buttons: "Cancel" on the left and "Log In" on the right.

Session Timeout - Inactivity Timeout

The web server monitors webpage usage and locks you out of the current session if no input or movement is detected for the time configured in Session Timeout field. The webpage goes to the default home page. If you wish to continue the session with user access, you can log in again using the Log In option at the top.

IMPORTANT The default value for the Session Timeout is 3 minutes. You cannot change the Session Timeout default value if you are using Firmware revision 1.011. From Firmware revision 1.012 onwards, you can change the default value 3 minutes to any value from 1...10 minutes in 1-minute increments.

To change the session timeout default value, proceed as follows:

1. Go to Services webpage.
2. Under Web Server, enter a Session Timeout (1...10 Minutes) value in 1-minute increments.
3. Select Apply.



Session timeout is based on the request sent to the web server from the Configuration pages only. If there are no requests processed from the Configuration pages for the configured time, the session times out.

Configure Session Timeout

Rockwell Automation 5032-CFGB16M12DR

Home

- ▶ Diagnostics
- ▼ Configuration
 - Internet Protocol
 - Port Configuration
 - Web Security Setup
 - Change Password
- Services**

Services

Reset the Module

Type 0 (Power Cycle)

Apply Reset

Web Server

Enable Disable

Session Timeout (in 1 to 10 Minutes)

Apply

SNMP

Enable Disable

Apply

Web Server Security

The web server employs HTTPS for secure and encrypted connections with clients. HTTPS uses SSL/TLS certificates to achieve its security goals.

The ArmorBlock 5000 16-channel configurable digital I/O module uses two types of certificates:

- A self-signed certificate – Automatically generated by the module itself during its initial power-on following a factory reset
- A CA-signed certificate – Obtained by having the certificate signed through a Certificate Authority

Generate a Self-signed Certificate

The module comes with an out-of-box self-signed certificate that is generated using the ECC algorithm.

Figure 21 - Self-signed Certificate Web Security Setup

The screenshot shows the 'Web Security Setup' page in the Rockwell Automation web interface. The page title is 'Web Security Setup' and the device ID is '5032-CFGB16M12DR'. The left sidebar contains navigation options: Home, Diagnostics, Configuration, Network, Port, Web Security Setup (selected), Change Password, and Services. The main content area asks for the following information:

- What identity do you want to give this device in its security certificate?**
 - Name of the device: 5032-CFGB16M12M12LDR
- What organization owns this device (optional)?**
 - Organization Name: Rockwell Automation Inc.
 - Country Name: US
 - Locality Name: Milwaukee
- Certificate Algorithm:**
 - ECC RSA
- Certificate Validity (in Years):** 1 (Default)

Below the form, there is a note: 'To obtain an HTTPS certificate that identifies the device to web browsers, you must complete one of the following two options.' Under 'Option 1: Self-sign a certificate', it says 'Generate a self signed certificate. No external certificate authority is involved.' A 'Self-sign a certificate' button is at the bottom.

To generate a self-signed certificate, complete these steps:

1. From the Web Security Setup page, enter the necessary details shown in [Figure 21](#). **You must enter the device name.**



When entering your country code, you must adhere to the 2-character country code standards in ISO 3166-1 (alpha-2).

2. Select whether to generate the certificate using the ECC or the RSA algorithm.
3. Select Self-sign a certificate.

The self-signed ECC certificate generates in approximately five seconds, whereas the RSA certificate generates in approximately 50 seconds. Once the certificate is generated, the web server restarts, and the generated certificate is used.

Upload a CA-signed Certificate

You can upload a CA-signed certificate based on the Certificate Signing request (CSR) generated from the module.

Figure 22 - CA-signed Certificate Web Security Setup

The screenshot shows the 'Web Security Setup' page in the Rockwell Automation interface. The page title is 'Web Security Setup' and the device ID is '5032-CFGB16M12DR'. The page asks 'What identity do you want to give this device in its security certificate?' and provides input fields for 'Name of the device' (5032-CFGB16M12DR), 'Organization Name' (Rockwell Automation Inc.), 'Country Name' (US), and 'Locality Name' (Milwaukee). It also has radio buttons for 'Certificate Algorithm' (ECC selected, RSA unselected) and a 'Certificate Validity (in Years)' field (1(Default)). Below this, it states: 'To obtain an HTTPS certificate that identifies the device to web browsers, you must complete one of the following two options.' Option 1 is 'Self-sign a certificate' with a 'Self-sign a certificate' button. Option 2 is 'Manually obtain a certificate from a certificate authority' with a 'Download CSR' button, a 'Browse...' button for the certificate file, and an 'Upload a certificate' button.

To upload a CA-signed certificate, complete these steps:

1. From the Web Security Setup page, enter the necessary details shown in [Figure 22](#). **You must enter the device name.**
2. Select whether to generate the CSR using the ECC or the RSA algorithm.
3. Select Download CSR.

The CSR generates in approximately five seconds for the ECC algorithm, whereas the CSR generates in approximately 50 seconds for the RSA algorithm. Once the CSR is generated, you can retrieve the CSR in the Downloads folder.

4. Use the generated CSR to have a Certificate Authority (CA).
5. Once you have the CSR signed by a CA, you can use the Browse... option to navigate to the location where you stored the certificate.
6. Select Upload a certificate.

Once the certificate is uploaded, the web server restarts, and the uploaded certificate is used.



- The device name should be between 8...64 characters in length.
- We recommend that you close the browser and re-open it in order to see the newly generated or uploaded certificates.
- A self-signed certificate is automatically generated whenever you change the IP address.
- Once you upload a CA-signed certificate, the web server will only use the CA-signed certificate. If you regenerate a self-signed certificate, it will not take effect.

Navigate the Web Server

Navigate the web server pages by using the navigation panel on the left of the screen. To view the Configuration page you must be logged in to the web server.

Figure 23 - Navigate the Web Server Pages

The screenshot shows the Rockwell Automation web server interface for a 5032-CFGB16M12M12LDR module. The left navigation panel includes: Home, Diagnostics (selected), Diagnostic Overview, Network Settings, IO Connections, Ethernet Statistics, Configuration (expanded), Identity, Network, Port, Custom IP, Web Security Setup, User Setup, and Services. The main content area is titled 'Diagnostic Overview' and includes a 'Refresh Interval' set to 5 seconds. It displays several data tables:

Module Resource Utilization (All Ports)		I/O Packets Per Second (EtherNet/IP Port)	
CPU	4 %	Total	0
I/O Comms Utilization	0 %	Sent	0
		Received	0

CIP Connection Statistics (All Ports)		I/O Packet Counts (EtherNet/IP Port)	
Active total	0	Missed	0
Active Class 3	0		
Active I/O	0		
Maximum Total Supported	31		

TCP Connections (EtherNet/IP Port)	
Active	1
Maximum Supported	32

Explicit Messages	
Packets Sent and Received Per Second	0

Diagnostics pages are read-only. Read-only pages automatically refresh according to the configured Refresh Interval, set in seconds. The default Refresh Interval is set to 5 seconds, which is both the minimum and initial value. You can adjust the Refresh Interval up to a maximum of 15 seconds. If you set the Refresh Interval to 0, auto-refresh is disabled.

From the Diagnostics page, you can monitor general diagnostics information such as:

- Module resource utilization
- Network information
- I/O connection details
- Ethernet statistics

From the Configuration page, you can enter or update information such as:

- Network configuration
 - Manual^(a)
 - DHCP^(a)
 - Network address switches^(b)
- Port configuration
- Web security setup
- Change password
- Services
 - Module reset
 - Disable web server
 - SNMP enable or disable



You cannot update Configuration pages while the module is in Explicit or Implicit Protection mode.

(a) When network address switches are set to 999, you can manually set network configuration or use DHCP.

(b) When network address switches are set between 1...254, you can set the network configuration with the last octet of the IP address from the network address switch.

EDS AOP and Assemblies

The ArmorBlock 5000 16-channel configurable digital I/O module allows you work with Data Generic assemblies to access or update its channel configuration settings, output and input tags, using Electronic Data Sheet (EDS) Add-on Profile (AOP) or Generic AOP.

To use EDS AOP, upload the latest EDS file from the device and install the file. After installation is complete, add the module to the project as described in [Add the Module to a Studio 5000 Logix Designer Application Project on page 50](#).

IMPORTANT With generic data connection, you can establish a connection with zero configuration data.
When you use this type of connection, the configuration parameters for the Input and Output are set to their default values. For information on the configuration parameters default values, see [Table 28](#).

ArmorBlock 5000 Assemblies

Configuration Assembly

1. Configuration Assembly
 - Instance ID = 0xF2 (242)
 - Size = 192 bytes

Name	Data Type	Bytes	Valid Values
AB:5000_DIO_Timestamp_Channel:C:0 Pt[00...15]	User-defined	192	User-defined data type for AB:5000_DIO_Timestamp_Channel:C:0 For information to add each member, see Discrete Configurable Timestamp Channel .

2. Discrete Configurable Timestamp Channel
 - Data Type = AB:5000_DIO_Timetamp_Channel:C:0
 - Size = 12 bytes

Name	Data Type	Bytes	Valid Values
AB:5000_DO_Channel:C:0 DO	User-defined	4	User-defined data type for AB:5000_DO_Channel:C:0 For information to add each member, see Configuration Discrete Output Channel .
AB:5000_DI_Timestamp_Channel:C:0 DI	User-defined	8	User-defined data type for AB:5000_DI_Timestamp_Channel:C:0 For information to add each member, see Configuration Discrete Input Timestamp Channel .

3. Configuration Discrete Output Channel

- Data Type = AB:5000_DO_Channel:C:0
- Size = 4 bytes

Name	Data Type	Bytes	Valid Values
FaultMode	BOOL	1	See Table 28
FaultValue	BOOL		
ProgMode	BOOL		
ProgValue	BOOL		
FaultFinalState	BOOL		
ProgramToFaultEn	BOOL		
Reserved1...Reserved2	BOOL		
FaultValueStateDuration	SINT	1	See Table 28
Reserved3	INT	2	—

4. Configuration Discrete Input Timestamp Channel

- Data Type = AB:5000_DI_Timestamp_Channel:C:0
- Size = 8 bytes

Name	Data Type	Bytes	Valid Values
InputOffOnFilter	SINT	1	See Table 28
InputOnOffFilter	SINT	1	
ChatterTime	INT	2	
ChatterCount	SINT	1	
CaptureOffOnEn	BOOL	1	
CaptureOnOffEn	BOOL		
TimestampLatchEn	BOOL		
Reserved1...Reserved5	BOOL	—	
Reserved6	INT	2	—

Input Assembly

1. Input Assembly

- Instance ID = 0xF1 (241)
- Size = 384 bytes

Name	Data Type	Bytes	Valid Values
AB:5000_DIO_Timestamp_Channel:I:0 Pt[00...15]	User-defined	384	User-defined data type for AB:5000_DIO_Timestamp_Channel:I:0 For information to add each member, see Discrete Configurable Timestamp Channel .

2. Discrete Configurable Timestamp Channel

- Data Type = AB:5000_DIO_Timestamp_Channel:I:0
- Size = 24 bytes

Name	Data Type	Bytes	Valid Values
Data	BOOL	2	See Table 29
Fault	BOOL		
Uncertain	BOOL		
Reserved1...Reserved2	BOOL		
Chatter	BOOL		
Reserved3...Reserved8	BOOL		
TimestampOverflowOffOn	BOOL		
TimestampOverflowOnOff	BOOL		
CIPSyncValid	BOOL		
CIPSyncTimeout	BOOL		
Reserved9	BOOL	2	—
OutputEnabled	BOOL		See Table 29
Reserved10...Reserved23	BOOL		—
TimestampOffOnNumber	INT	2	See Table 29
TimestampOnOffNumber	INT	2	
TimestampOffOn	LINT	8	
TimestampOnOff	LINT	8	

Output Assembly

1. Output Assembly

- InstanceID = 0xF0 (240)
- Size = 128 bytes

Name	Data Type	Bytes	Valid Values
AB:5000_DIO_Timestamp_Channel:0:0 Pt[00...15]	User-defined	128	User-defined data type for AB:5000_DIO_Timestamp_Channel:0:0 For information to add each member, see Discrete Configurable Timestamp Channel .

2. Discrete Configurable Timestamp Channel

- Data Type = AB:5000_DIO_Timestamp_Channel:0:0
- Size = 8 bytes

Name	Data Type	Bytes	Valid Values
Data	BOOL	1	See Table 30
Reserved1...Reserved2	BOOL		—
ResetTimestamps	BOOL		See Table 30
Reserved3...Reserved5	BOOL		—
Reserved6	SINT		1
Reserved7	BOOL	1	—
OutputEn	BOOL		See Table 30
Reserved8...Reserved13	BOOL	—	—
Reserved14	SINT	1	—
TimestampOffOnNumberAck	INT	2	See Table 30
TimestampOnOffNumberAck	INT	2	—

Notes:

C

- compatibility**
 - hardware and software 11
- configurable digital I/O module**
 - reset to factory default 79
- configurable digital I/O module events**
 - timestamp 55
- configuration**
 - connections 14
 - device definition
 - point assignments 54
 - module tags 90
- connection types**
 - module definition 55
- connection view**
 - module 58
 - troubleshoot 84
- connections**
 - broadcast method 58
 - inhibit module 58
 - overview 14
- controllers**
 - compatibility 11

D

- device**
 - device definition
 - point assignments 54
 - device information view 59
 - points view 60
- device definition**
 - point assignments
 - device 54
- Device Definition - Point Assignments** 54
- device information view**
 - device 59
 - troubleshoot 85
- devices**
 - connections 14
- discover**
 - configurable digital I/O module 50

E

- electronic keying**
 - module 55
- events**
 - configuration 19

F

- FactoryTalk Linx**
 - compatibility 11
- firmware**
 - download from PCDC 19
 - protected operations 15, 27, 28

I

- I/O configuration**
 - troubleshoot 83
- I/O configuration tree**
 - add module 50, 52
- inhibit**
 - module 18
- input events view**
 - module 69
- internet protocol view**
 - module 72

L

- Logix Designer application**
 - compatibility 11
 - connection view 58
 - device definition
 - point assignments 54
 - device information view 59
 - input events view 69
 - internet protocol view 72
 - module tag definitions 90
 - network view 73
 - overview view 54
 - points view 60
 - port configuration view 73
 - servers view 75
 - tag editor 89
 - time sync view 74

M

- module**
 - connection view 58
 - connections 14
 - inhibit 58
 - input events view 69
 - internet protocol view 72
 - network view 73
 - overview view 54
 - port configuration view 73
 - reset to factory default 79
 - servers view 75
 - time sync view 74
- module operation**
 - overview 14
- module properties**
 - troubleshoot 84
- module tags**
 - definition 90
 - naming 89
 - tag editor 89

N

- network address**
 - example 49
 - set 49
- network address switches**
 - protection mode 50

network view

module 73

new module

configurable digital I/O module 52

O**overview view**

module 54

ownership

Logix 5000 controllers 13

P**points view**

device 60

port configuration view

module 73

power supply considerations 13**Product Compatibility and Download Center (PCDC)**

download firmware 19

protection mode

module 26

network address switches 50

R**Requested Packet Interval (RPI)**

module 58

overview 14

protected operations 15

S**secure access 12****servers view**enable/disable SNMP 75
module 75**status indicator**link status 82
module status 81
network status 81
point status 82
power status 82**T****tags**access tags 89
module 90**time sync view**

module 74

timestamp

module definition 55

troubleshootconnection view 84
device information view 85
Logix Designer application 83
module properties 83, 84
reset to factory default 79
status indicators 81, 82
tag editor 87

Rockwell Automation Support

Use these resources to access support information.

Technical Support Center	Find help with how-to videos, FAQs, chat, user forums, Knowledgebase, and product notification updates.	rok.auto/support
Local Technical Support Phone Numbers	Locate the telephone number for your country.	rok.auto/phonesupport
Technical Documentation Center	Quickly access and download technical specifications, installation instructions, and user manuals.	rok.auto/techdocs
Literature Library	Find installation instructions, manuals, brochures, and technical data publications.	rok.auto/literature
Product Compatibility and Download Center (PCDC)	Download firmware, associated files (such as AOP, EDS, and DTM), and access product release notes.	rok.auto/pcdc

Documentation Feedback

Your comments help us serve your documentation needs better. If you have any suggestions on how to improve our content, complete the form at rok.auto/docfeedback.

Waste Electrical and Electronic Equipment (WEEE)



At the end of life, this equipment should be collected separately from any unsorted municipal waste.

Rockwell Automation maintains current product environmental compliance information on its website at rok.auto/pec.

Allen-Bradley, ArmorBlock 5000, CompactLogix, ControlLogix, expanding human possibility, FactoryTalk, FactoryTalk Linx, GuardLogix, Logix 5000, Rockwell Automation, Studio 5000 Logix Designer, and TechConnect are trademarks of Rockwell Automation, Inc.

CIP Sync and EtherNet/IP are trademarks of ODVA, Inc.





Microsoft Edge is a trademark of Microsoft Corporation.

Google Chrome is a trademark of Google LLC.

Mozilla Firefox is a trademark of Mozilla Foundation.

Trademarks not belonging to Rockwell Automation are property of their respective companies.

Rockwell Otomasyon Ticaret A.Ş. Kar Plaza İş Merkezi E Blok Kat:6 34752, İçerenköy, İstanbul, Tel: +90 (216) 5698400 EEE Yönetmeliğine Uygundur

Connect with us.    

rockwellautomation.com — expanding **human possibility**[®]

AMERICAS: Rockwell Automation, 1201 South Second Street, Milwaukee, WI 53204-2496 USA, Tel: (1) 414.382.2000

EUROPE/MIDDLE EAST/AFRICA: Rockwell Automation NV, Pegasus Park, De Kleetlaan 12a, 1831 Diegem, Belgium, Tel: (32) 2663 0600

ASIA PACIFIC: Rockwell Automation SEA Pte Ltd, 2 Corporation Road, #04-05, Main Lobby, Corporation Place, Singapore 618494, Tel: (65) 6510 6608

UNITED KINGDOM: Rockwell Automation Ltd., Pitfield, Kiln Farm, Milton Keynes, MK11 3DR, United Kingdom, Tel: (44)(1908) 838-800

Publication 5032-UM002C-EN-P - March 2026

Supersedes Publication 5032-UM002B-EN-P - November 2024

Copyright © 2026 Rockwell Automation, Inc. All rights reserved.