



FLEX 5000 Digital 4-point Isolated Relay Safety Output Modules

Catalog Numbers 5094-0W4IS, 5094-0W4ISXT

Topic	Page
Summary of Changes	1
Product Overview	1
About the Module	5
Install a FLEX 5000 I/O System	5
Install the Module	6
Install the End Cap	6
Wire the Terminal Base	7
Disconnect Wires from the Terminal Base	8
Wiring Diagram	8
Power the System	9
Remove the Module	9
Module Specifications	9
Additional Resources	10

Summary of Changes

This publication contains the following new or updated information. This list includes substantive updates only and is not intended to reflect all changes.

Topic	Page
Updated back cover	Back Cover

Product Overview

The 5094-0W4IS and 5094-0W4ISXT digital 4-point isolated relay safety output modules drive output devices. The data sent to the modules from a safety controller and from some input modules determine the 5094-0W4IS and 50494-0W4ISXT module behavior.

FLEX 5000® I/O modules use the Producer/Consumer communication model. The Producer/Consumer communication model is an intelligent data exchange between modules and other system devices in which each module produces data without first being polled.

The 5094-0W4IS and 5094-0W4ISXT modules can be used with GuardLogix® 5580 and Compact GuardLogix 5380 safety controllers in applications up to SIL 3, PLe, Cat. 4 in single-channel and dual-channel configurations. The modules are configured with the Studio 5000 Logix Designer® application.

These safety modules are type-approved and certified for use in safety applications up to and including SIL 3 per IEC 61508, suitable for use in safety applications up to and including SIL Class 3 per IEC 62061, and up to and including Performance Level PLe (Category 4) per ISO 13849-1.

For more information about which Logix 5000® controllers and Studio 5000 Logix Designer application versions are compatible with FLEX 5000 I/O modules, and for safety application requirements, see the publications that are listed in [Additional Resources on page 10](#).



ATTENTION: Read this document and the documents listed in the Additional Resources section about installation, configuration and operation of this equipment before you install, configure, operate or maintain this product. Users are required to familiarize themselves with installation and wiring instructions in addition to requirements of all applicable codes, laws, and standards.

Activities including installation, adjustments, putting into service, use, assembly, disassembly, and maintenance are required to be carried out by suitably trained personnel in accordance with applicable code of practice.

If this equipment is used in a manner not specified by the manufacturer, the protection provided by the equipment may be impaired.

注意：在安装、配置、操作和维护本产品前，请阅读本文档以及“其他资源”部分列出的有关设备安装、配置和操作的相应文档。除了所有适用规范、法律和标准的相关要求之外，用户还必须熟悉安装和接线说明。

安装、调整、投运、使用、组装、拆卸和维护等各项操作必须由经过适当训练的专业人员按照适用的操作规范实施。

如果未按照制造商指定的方式使用该设备，则可能会损害设备提供的保护。

ATENCIÓN: Antes de instalar, configurar, poner en funcionamiento o realizar el mantenimiento de este producto, lea este documento y los documentos listados en la sección Recursos adicionales acerca de la instalación, configuración y operación de este equipo. Los usuarios deben familiarizarse con las instrucciones de instalación y cableado y con los requisitos de todos los códigos, leyes y estándares vigentes.

El personal debidamente capacitado debe realizar las actividades relacionadas a la instalación, ajustes, puesta en servicio, uso, ensamblaje, desensamblaje y mantenimiento de conformidad con el código de práctica aplicable.

Si este equipo se usa de una manera no especificada por el fabricante, la protección provista por el equipo puede resultar afectada.

ATENÇÃO: Leia este e os demais documentos sobre instalação, configuração e operação do equipamento que estão na seção Recursos adicionais antes de instalar, configurar, operar ou manter este produto. Os usuários devem se familiarizar com as instruções de instalação e fiação além das especificações para todos os códigos, leis e normas aplicáveis.

É necessário que as atividades, incluindo instalação, ajustes, colocação em serviço, utilização, montagem, desmontagem e manutenção sejam realizadas por pessoal qualificado e especializado, de acordo com o código de prática aplicável.

Caso este equipamento seja utilizado de maneira não estabelecida pelo fabricante, a proteção fornecida pelo equipamento pode ficar prejudicada.

ВНИМАНИЕ: Перед тем как устанавливать, наладку, вводить в эксплуатацию, использовать, сборку, разборку и техническое обслуживание, прочитайте этот документ и документы, перечисленные в разделе «Дополнительные ресурсы». В этих документах изложены сведения об установке, настройке и эксплуатации данного оборудования. Пользователи обязаны ознакомиться с инструкциями по установке и прокладке соединений, а также с требованиями всех применимых норм, законов и стандартов.

Все действия, включая установку, наладку, ввод в эксплуатацию, использование, сборку, разборку и техническое обслуживание, должны выполняться обученным персоналом в соответствии с применимыми нормами и правилами.

Если оборудование используется не предусмотренным производителем образом, защита оборудования может быть нарушена.

注意：本製品を設置、構成、稼働または保守する前に、本書および本機器の設置、設定、操作についての参考資料の該当箇所に記載されている文書に目を通してください。コーザは、すべての該当する条例、法律、規格の要件に加えて、設置および配線の手順に習熟している必要があります。

設置調整、運転の開始、使用、組立て、解体

、保守を含む諸作業は、該当する実施規則に従って訓練を受けた適切な作業員が実行する必要があります。

本機器が製造メーカーにより指定されていない方法で使用されている場合、機器により提供されている保護が損なわれる恐れがあります。

ACHTUNG: Lesen Sie dieses Dokument und die im Abschnitt „Weitere Informationen“ aufgeführten Dokumente, die Informationen zu Installation, Konfiguration und Bedienung dieses Produkts enthalten, bevor Sie dieses Produkt installieren, konfigurieren, bedienen oder warten. Anwender müssen sich neben den Bestimmungen aller anwendbaren Vorschriften, Gesetze und Normen zusätzlich mit den Installations- und Verdrahtungsanweisungen vertraut machen.

Arbeiten im Rahmen der Installation, Anpassung, Inbetriebnahme, Verwendung, Montage, Demontage oder Instandhaltung dürfen nur durch ausreichend geschulte Mitarbeiter und in Übereinstimmung mit den anwendbaren Ausführungsvorschriften vorgenommen werden.

Wenn das Gerät in einer Weise verwendet wird, die vom Hersteller nicht vorgesehen ist, kann die Schutzfunktion beeinträchtigt sein.

ATTENTION: Lisez ce document et les documents listés dans la section Ressources complémentaires relatifs à l'installation, la configuration et le fonctionnement de cet équipement avant d'installer, configurer, utiliser ou entretenir ce produit. Les utilisateurs doivent se familiariser avec les instructions d'installation et de câblage en plus des exigences relatives aux codes, lois et normes en vigueur. Les activités relatives à l'installation, le réglage, la mise en service, l'utilisation, l'assemblage, le démontage et l'entretien doivent être réalisées par des personnes formées selon le code de pratique en vigueur.

Si cet équipement est utilisé d'une façon qui n'a pas été définie par le fabricant, la protection fournie par l'équipement peut être compromise.

주의：본 제품 설치, 설정, 작동 또는 유지 보수하기 전에 본 문서를 포함하여 설치, 설정 및 작동에 관한 참고 자료 섹션의 문서들을 반드시 읽고 숙지하십시오. 사용자는 모든 관련 규정, 법규 및 표준에서 요구하는 사항에 대해 반드시 설치 및 배선 지침을 숙지해야 합니다.

설치, 조정, 가동, 사용, 조립, 분해, 유지보수 등 모든 작업은 관련 규정에 따라 적절한 교육을 받은 사용자가 통해서만 수행해야 합니다.

본 장비를 제조사가 명시하지 않은 방법으로 사용하면 장비의 보호 기능이 손상될 수 있습니다.

ATTENZIONE: Prima di installare, configurare ed utilizzare il prodotto, o effettuare interventi di manutenzione su di esso, leggere il presente documento ed i documenti elencati nella sezione "Altre risorse", riguardanti l'installazione, la configurazione ed il funzionamento dell'apparecchiatura. Gli utenti devono leggere e comprendere le istruzioni di installazione e cablaggio, oltre ai requisiti previsti dalle leggi, codici e standard applicabili.

Le attività come installazione, regolazioni, utilizzo, assemblaggio, disassemblaggio e manutenzione devono essere svolte da personale adeguatamente addestrato, nel rispetto delle procedure previste. Qualora l'apparecchio venga utilizzato con modalità diverse da quanto previsto dal produttore, la sua funzione di protezione potrebbe venire compromessa.

DİKKAT: Bu ürünün kurulumu, yapılandırılması, işletilmesi veya bakımı öncesinde bu dokümanı ve bu ekipmanın kurulumu, yapılandırılması ve işletimi ile ilgili İlave Kaynaklar bölümünde yer listelenmiş dokümanları okuyun. Kullanıcılar yürürlükteki tüm yönetmelikler, yasalar ve standartların gereksinimlerine ek olarak kurulum ve kablolama talimatlarını da öğrenmek zorundadır.

Kurulum, ayarlar, hizmete alma, kullanma, parçaları birleştirme, parçaları sökme ve bakım gibi aktiviteler sadece uygun eğitimleri almış kişiler tarafından yürürlükteki uygulama yönetmeliklerine uygun şekilde yapılabilir.

Bu ekipman üretici tarafından belirlenmiş amacın dışında kullanılırsa, ekipman tarafından sağlanan koruma bozulabilir.

注意事項：在安装、設定、操作或維護本产品前，請先閱讀此文件以及列於「其他資源」章節中有關安裝、設定與操作此設備的文件。使用者必須熟悉安裝和配線指示，並符合所有法規、法律和標準要求。

包括安裝、調整、交付使用、使用、組裝、拆卸和維護等動作都必須交由已經過適當訓練的人員進行，以符合適用的實作法規。

如果將設備用於非製造商指定的用途時，可能會造成設備所提供的保護功能受損。

POZOR: Než začnete instalovat, konfigurovat či provázovat tento výrobek nebo provádět jeho údržbu, přečtěte si tento dokument a dokumenty uvedené v části Dodatečné zdroje ohledně instalace, konfigurace a provozu tohoto zařízení. Uživatelé se musejí vedle požadavků všech relevantních vyhlášek, zákonů a norem nutně seznámit také s pokyny pro instalaci a elektrické zapojení.

Činnosti zahrnující instalaci, nastavení, uvedení do provozu, užívání, montáž, demontáž a údržbu musí vykonávat vhodně proškolený personál v souladu s příslušnými prováděcími předpisy.

Pokud se toto zařízení používá způsobem neodpovídajícím specifikaci výrobce, může být narušena ochrana, kterou toto zařízení poskytuje.

UWAGA: Przed instalacją, konfiguracją, użytkowaniem lub konserwacją tego produktu należy przeczytać niniejszy dokument oraz wszystkie dokumenty wymienione w sekcji Dodatkowe źródła omawiające instalację, konfigurację i procedury użytkowania tego urządzenia. Użytkownicy mają obowiązek zapoznać się z instrukcjami dotyczącymi instalacji oraz oprzewodowania, jak również z obowiązującymi kodeksami, prawem i normami.

Działania obejmujące instalację, regulację, przekazanie do użytkowania, użytkowanie, montaż, demontaż oraz konserwację muszą być wykonywane przez odpowiednio przeszkolony personel, zgodnie z obowiązującym kodeksem postępowania.

Jeśli urządzenie jest użytkowane w sposób inny niż określony przez producenta, zabezpieczenie zapewniane przez urządzenie może zostać ograniczone.

OBBS! Läs detta dokument samt dokumentet, som står listat i avsnittet Övriga resurser, om installation, konfigurering och drift av denna utrustning innan du installerar, konfigurerar eller börjar använda eller utföra underhållsarbete på produkten. Användare måste bekanta sig med instruktioner för installation och kabeldragning, förutom krav enligt gällande koder, lagar och standarder.

Åtgärder som installation, justering, service, användning, montering, demontering och underhållsarbete måste utföras av personal med lämplig utbildning enligt lämpligt bruk.

Om denna utrustning används på ett sätt som inte anges av tillverkaren kan det hända att utrustningens skyddsanordningar försätts ur funktion.

LET OP: Lees dit document en de documenten die genoemd worden in de paragraaf Aanvullende informatie over de installatie, configuratie en bediening van deze apparatuur voordat u dit product installeert, configureert, bedient of onderhoudt. Gebruikers moeten zich vertrouwd maken met de installatie en de bedravingsinstructies, naast de vereisten van alle toepasselijke regels, wetten en normen.



Activiteiten zoals het installeren, afstellen, in gebruik stellen, gebruiken, monteren, demonteren en het uitvoeren van onderhoud mogen uitsluitend worden uitgevoerd door hiervoor opgeleid personeel en in overeenstemming met de geldende praktijkregels.

Indien de apparatuur wordt gebruikt op een wijze die niet is gespecificeerd door de fabrikant, dan bestaat het gevaar dat de beveiliging van de apparatuur niet goed werkt.



WARNING: For Class I Division 2 applications, use only Class I Division 2 listed or recognized accessories and modules approved for use within the FLEX 5000 platform. When used in a Class I Division 2, hazardous location, this equipment must be mounted in a suitable enclosure with proper wiring method that complies with the governing electrical codes.

North American Hazardous Location Approval

This information applies when operating this equipment in hazardous locations.	Informations sur l'utilisation de cet équipement en environnements dangereux.
<p>Products marked "CL I, DIV 2, GP A, B, C, D" are suitable for use in Class I Division 2 Groups A, B, C, D, Hazardous Locations and nonhazardous locations only. Each product is supplied with markings on the rating nameplate indicating the hazardous location temperature code. When combining products within a system, the most adverse temperature code (lowest "T" number) may be used to help determine the overall temperature code of the system. Combinations of equipment in your system are subject to investigation by the local Authority Having Jurisdiction at the time of installation.</p>	<p>Les produits marqués "CL I, DIV 2, GP A, B, C, D" ne conviennent qu'à une utilisation en environnements de Classe I Division 2 Groupes A, B, C, D dangereux et non dangereux. Chaque produit est livré avec des marquages sur sa plaque d'identification qui indiquent le code de température pour les environnements dangereux. Lorsque plusieurs produits sont combinés dans un système, le code de température le plus défavorable (code de température le plus faible) peut être utilisé pour déterminer le code de température global du système. Les combinaisons d'équipements dans le système sont sujettes à inspection par les autorités locales qualifiées au moment de l'installation.</p>
<div style="display: flex; align-items: center;">  <div> <p>WARNING: EXPLOSION HAZARD</p> <ul style="list-style-type: none"> Do not disconnect equipment unless power has been removed or the area is known to be nonhazardous. Do not disconnect connections to this equipment unless power has been removed or the area is known to be nonhazardous. Secure any external connections that mate to this equipment by using screws, sliding latches, threaded connectors, or other means provided with this product. Substitution of components may impair suitability for Class I Division 2. </div> </div>	<div style="display: flex; align-items: center;">  <div> <p>AVERTISSEMENT: RISQUE D'EXPLOSION</p> <ul style="list-style-type: none"> Couper le courant ou s'assurer que l'environnement est classé non dangereux avant de débrancher l'équipement. Couper le courant ou s'assurer que l'environnement est classé non dangereux avant de débrancher les connecteurs. Fixer tous les connecteurs externes reliés à cet équipement à l'aide de vis, loquets coulissants, connecteurs filetés ou autres moyens fournis avec ce produit. La substitution de composants peut rendre cet équipement inadapté à une utilisation en environnement de Classe I Division 2. </div> </div>

UK and European Hazardous Location Approval

<p>The following applies to products marked  II 3 G:</p> <ul style="list-style-type: none"> Are Equipment Group II, Equipment Category 3, and comply with the Essential Health and Safety Requirements relating to the design and construction of such equipment given in Schedule 1 of UKEX and Annex II to EU Directive 2014/34/EU. See the UK EX and EU Declaration of rok.auto/certifications for details. The type of protection is "Ex ec nC IIC T4 Gc" according to EN IEC 60079-0, EXPLOSIVE ATMOSPHERES - PART 0: EQUIPMENT - GENERAL REQUIREMENTS, Issue Date 07/2018, EN IEC 60079-7: 2015+A1:2018 Explosive atmospheres, Equipment protection by increased safety "e" and EN IEC 60079-15:2019 Explosive atmospheres, Equipment protection by type protection "n". Comply with Standards EN IEC 60079-0, EXPLOSIVE ATMOSPHERES - PART 0: EQUIPMENT - GENERAL REQUIREMENTS, Issue Date 07/2018, EN IEC 60079-7:2015+A1:2018 Explosive atmospheres, Equipment protection by increased safety "e" and EN IEC 60079-15:2019 Explosive atmospheres, Equipment protection by type protection "n", reference certificate number DEMKO 17 ATEX 1922X and UL21UKEX2275X. Are intended for use in areas in which explosive atmospheres caused by gases, vapors, mists, or air are unlikely with occur, or are likely to occur only infrequently and for short periods. Such locations correspond to Zone 2 classification according to UKEX regulation 2016 No. 1107 and ATEX directive 2014/34/EU.
--

IEC Hazardous Location Approval

<p>The following applies to products with IECEx certification:</p> <ul style="list-style-type: none"> Are intended for use in areas in which explosive atmospheres caused by gases, vapors, mists, or air are unlikely to occur, or are likely to occur only infrequently and for short periods. Such locations correspond to Zone 2 classification to IEC 60079-0. The type of protection is "Ex ec nC IIC T4 Gc" according to IEC 60079-0, IEC 60079-7 and IEC 60079-15. Comply with Standards IEC 60079-0, Explosive atmospheres - Part 0: Equipment - General requirements, Edition 7, Revision Date 2017, IEC 60079-7, 5.1 Edition revision date 2017, Explosive atmospheres - Part 7: Equipment protection by increased safety "e" and IEC 60079-15, 5.0 Edition revision date 2017, Explosive atmospheres - Part 15: Equipment protection by type protection "n", reference IECEx certificate number IECEx UL 17.0075X.

Special Conditions for Safe Use

<div style="display: flex; align-items: flex-start;">  <div> <p>WARNING:</p> <ul style="list-style-type: none"> This equipment is not resistant to sunlight or other sources of UV radiation. This equipment shall be mounted in an UKEX/ATEX/IECEx Zone 2 certified enclosure with a minimum ingress protection rating of at least IP54 (in accordance with EN/IEC 60079-0) and used in an environment of not more than Pollution Degree 2 (as defined in EN/IEC 60664-1) when applied in Zone 2 environments. The enclosure must be accessible only by the use of a tool. This equipment shall be used within its specified ratings defined by Rockwell Automation. Transient protection shall be provided that is set at a level not exceeding 140% of the peak rated voltage value at the supply terminals to the equipment. The instructions in the user manual shall be observed. This equipment must be used only with UKEX/ATEX/IECEx certified Rockwell Automation backplanes. Secure any external connections that mate to this equipment by using screws, sliding latches, threaded connectors, or other means provided with this product. Do not disconnect equipment unless power has been removed or the area is known to be nonhazardous. Earthing is accomplished through mounting of modules on rail. Devices shall be used in an environment of not more than Pollution Degree 2. The installer shall ensure that the service temperature of the suitably-certified enclosure and the "maximum ambient" temperature of the module when installed is not exceeded. </div> </div>
--

Prevent Electrostatic Discharge



ATTENTION: This equipment is sensitive to electrostatic discharge, which can cause internal damage and affect normal operation. Follow these guidelines when you handle this equipment:

- Touch a grounded object to discharge potential static.
 - Wear an approved grounding wriststrap.
 - Do not touch connectors or pins on component boards.
 - Do not touch circuit components inside the equipment.
 - Use a static-safe workstation, if available.
 - Store the equipment in appropriate static-safe packaging when not in use.
-

Electrical Safety Considerations



ATTENTION:

- All wiring must comply with applicable electrical installation requirements [N.E.C. article 501-4(b)].
 - Wire conductor and insulation ratings shall support minimum temperature rating of 105 °C (221 °F).
 - Do not wire more than one conductor on any terminal.
 - In case of malfunction or damage, no attempts at repair should be made. The module should be returned to the manufacturer for repair. Do not dismantle the module.
 - This equipment is certified for use only within the surrounding air temperature range of -40...+70 °C (-40...+158 °F). The equipment must not be used outside of this range.
 - Use only a soft dry anti-static cloth to wipe down equipment. Do not use any cleaning agents.
-

Environment and Enclosure



ATTENTION: This equipment is intended for use in a Pollution Degree 2 industrial environment, in overvoltage Category II applications (as defined in EN/IEC 60664-1), at altitudes up to 2000 m (6562 ft) without derating.

This equipment is not intended for use in residential environments and may not provide adequate protection to radio communication services in such environments.

This equipment is supplied as open-type equipment for indoor use. It must be mounted within an enclosure that is suitably designed for those specific environmental conditions that will be present and appropriately designed to prevent personal injury resulting from accessibility to live parts. The enclosure must have suitable flame-retardant properties to prevent or minimize the spread of flame, complying with a flame spread rating of 5VA or be approved for the application if nonmetallic. The interior of the enclosure must be accessible only by the use of a tool. Subsequent sections of this publication may contain additional information regarding specific enclosure type ratings that are required to comply with certain product safety certifications.

In addition to this publication, see the following:

- Industrial Automation Wiring and Grounding Guidelines, publication [1770-4.1](#), for more installation requirements.
 - NEMA Standard 250 and EN/IEC 60529, as applicable, for explanations of the degrees of protection provided by enclosures.
-



ATTENTION: Personnel responsible for the application of safety-related programmable electronic systems (PES) shall be aware of the safety requirements in the application of the system and shall be trained in using the system.

IMPORTANT

Any illustrations, charts, sample programs, and layout examples shown in this publication are intended solely for the purposes of example. Since there are many variables and requirements associated with any particular installation, Rockwell Automation does not assume responsibility or liability for actual use based upon the examples shown in this publication.



ATTENTION: For maximum noise immunity, input, and output cable return wires must be properly terminated. When inputs and outputs are connected in loopback, return wires should be connected together.

About the Module

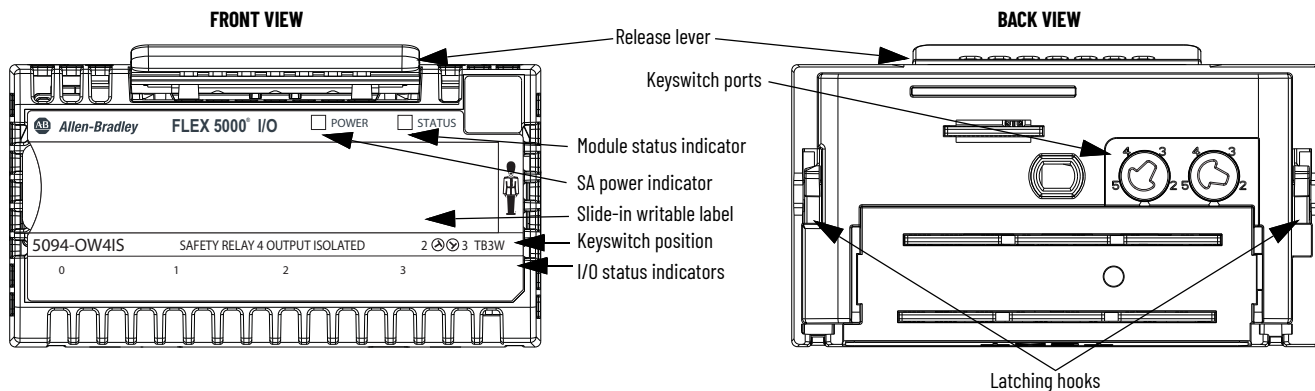

Install a FLEX 5000 I/O System

Before you install the module, you must install a FLEX 5000 I/O system. At minimum, the system must include a FLEX 5000 EtherNet/IP™ adapter and backplane end cap. For more information on how to install a FLEX 5000 I/O system, see the FLEX 5000 EtherNet/IP Adapters with RJ45 Ports Installation Instructions, publication [5094-IN001](#), and the FLEX 5000 Terminal Base Assembly Modules Installation Instructions, publication [5094-IN010](#).

You can install the module next to any FLEX 5000 I/O module.

IMPORTANT See FLEX 5000 Standard and Safety I/O Modules User Manual, publication [5094-UM001](#), for firmware and software requirements.

Required Components

To install the module, you need the physical components that are listed in the following table.

Components Needed for FLEX 5000 I/O Module Installation

Component	Description
Terminal base	IMPORTANT: Mounting bases (MBs) and removable terminal bases (RTBs) do not ship with the FLEX 5000 I/O modules. You must purchase the MB and RTB individually for each I/O module. 5094-MB plus 5094-RTB3W (referred to in documentation as a non-orderable 5094-TB3W) 5094-MB plus 5094-RTB3WS (referred to in documentation as a non-orderable 5094-TB3WS) 5094-MBXT plus 5094-RTB3WXT (referred to in documentation as a non-orderable 5094-TB3WXT) 5094-MBXT plus 5094-RTB3WSXT (referred to in documentation as a non-orderable 5094-TB3WSXT)
Backplane end cap	A backplane end cap ships with a FLEX 5000 EtherNet/IP adapter. You can order backplane end caps separately: 5094-ECR-QTY5 - Backplane end cap, Pack of 5.
Tools	The following tools are needed: Screwdriver, wire stripper, and wires. For more information about available wire sizes and wire insulation stripping length, see Module Specifications on page 9 .

Dimensions

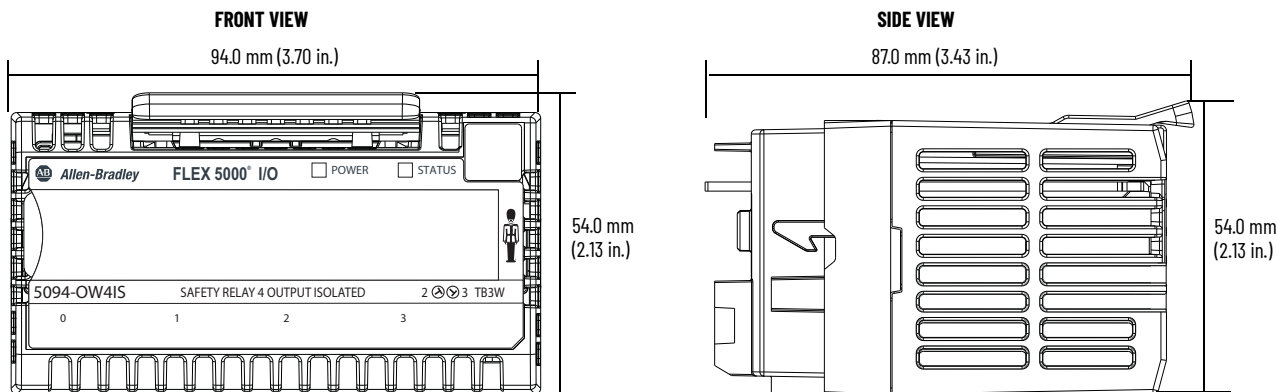

Ground Considerations

You must ground DIN rails according to the Industrial Automation Wiring and Grounding Guidelines, publication [1770-4.1](#).



ATTENTION: This product is grounded through the DIN rail to chassis ground. Use zinc-plated chromate-passivated steel DIN rail to assure proper grounding. The use of other DIN rail materials (for example, aluminum or plastic) that can corrode, oxidize, or are poor conductors can result in improper or intermittent grounding. Secure DIN rail to mounting surface approximately every 200 mm (7.8 in.) and use end-anchors appropriately. Be sure to ground the DIN rail properly. See Industrial Automation Wiring and Grounding Guidelines, publication [1770-4.1](#) for more information.

You can use a zinc-plated chromated steel DIN rail such as the Allen-Bradley® 199-DR1; 46277-3; EN60715 - 35 x 7.5 mm (1.38 x 0.30 in.) with your FLEX 5000 I/O system.

System Power Considerations



ATTENTION: Power to this equipment and all connected I/O must be supplied from a source compliant with the following: Isolated from Mains power via an approved Isolating Transformer constructed with Basic Insulation.

FLEX 5000 EtherNet/IP adapters provide power to a FLEX 5000 I/O system via a Power RTB that is connected to an external power supply and installed on the adapter.

The Power RTB provides module power to the system. Module power refers to system-side power that is used to operate the FLEX 5000 I/O system. Module power is provided through the Power RTB and passed across the module power bus.

- You must limit the SA field-side power source to **10 A, max, at 18...32V DC**.
- Confirm that the external module power supply is adequately sized for the total module power bus current draw in the system. For example, if the total module power current draw, including current inrush requirements, is 5 A, you can use a module power supply that is limited to 5 A.
- You must use SELV-listed power supplies for module power if there are functional safety modules that are connected to the FLEX 5000 I/O system.
- Not all power supplies are certified for use in all applications, for example, nonhazardous and hazardous environments.

IMPORTANT

We recommend that you use separate external power supplies for the adapter and the adjacent terminal base. This practice can prevent unintended consequences that can result if you use one supply.

For more information, see the publications that are listed in [Additional Resources on page 10](#).

Install the Module



WARNING: When you insert or remove the module while backplane power or SA power (field-side) is On, an electric arc can occur. This could cause an **explosion** in hazardous location installations. Be sure that power is removed or the area is nonhazardous before proceeding. Repeated electric arcing causes excessive wear to contacts on both the module and its mating connector. Worn contacts may create electrical resistance that can affect module operation.

The module mounts on a FLEX 5000 terminal base.

1. Rotate the left keyswitch on the terminal base clockwise to position 2, and the right keyswitch to position 3, as indicated on the module.
2. Position the module in front of the terminal base and make sure that the pins are aligned with the connectors in the terminal base.

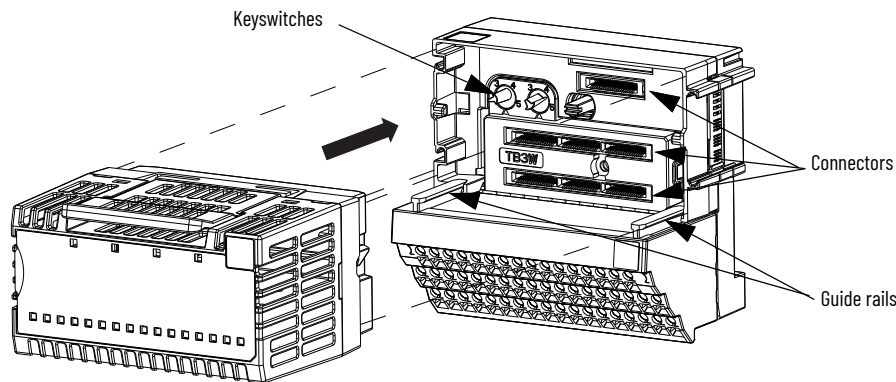

3. Press firmly and evenly to seat the module on the terminal base. The module is seated when the latching hooks are locked into the terminal base.

Install the End Cap



ATTENTION: Do not discard the end cap. Use this end cap to cover the exposed interconnections on the last mounting base on the DIN rail. Failure to do so could result in equipment damage or injury from electric shock.

An end cap is shipped with a FLEX 5000 EtherNet/IP adapter.

You must install an end cap on the right side of the last terminal base in a FLEX 5000 I/O system. The end cap covers the exposed interconnections on the adapter or on the last terminal base in the system. If you do not install the end cap before powering the system, equipment damage or injury from electric shock can result.

Once you have installed all your modules for your system, install the end cap on the last terminal base.

1. Make sure that the end cap is unlocked.
If the end cap is locked, pull the tab until it clicks.

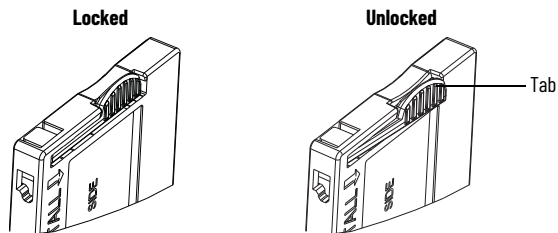

2. Align the end cap with interlocking pieces on the last terminal base in the system.

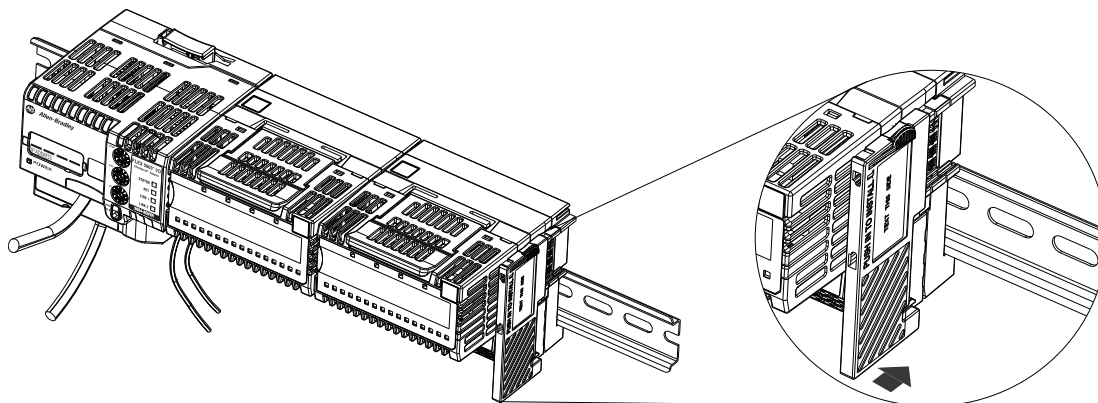

3. Push the end cap towards the DIN rail.
4. Press the locking tab until it clicks.

Wire the Terminal Base



WARNING: If you connect or disconnect wiring while the field-side power is On, an electric arc can occur. This could cause an **explosion** in hazardous location installations. Be sure that power is removed or the area is nonhazardous before proceeding.

1. Confirm that all sources of power to the module and terminal base are turned off.
2. Strip insulation from the wires that you connect to the terminal base.

TB Type	Action
Screw	0.34...2.5 mm ² (22...14 AWG) = Strip 12 ± 1 mm (0.47 ± 0.04 in.) of insulation from the wires Other = Strip 12 ± 1 mm (0.47 in ± 0.04 in) of insulation from the wires
Spring	0.34...1.5 mm ² (22...16 AWG) = Strip 10 ± 1 mm (0.39 ± 0.04 in.) of insulation from the wires 2.5 mm ² (14 AWG) = Strip 15 ± 1 mm (0.59 ± 0.04 in.) of insulation from the wires Other = Strip 10 ± 1 mm (0.39 ± 0.04 in.) of insulation from the wires

3. Connect the wires to the terminal base.

TB Type	Action
Screw	1. Insert the wire into the terminal. 2. Turn the screwdriver to close the terminal on the wire. Torque the screw to 0.4 N•m (3.5 lb•in).
Spring	Push the wire into the terminal. If the wire is too thin, crimp a wire ferrule on the wire and insert it.



4. Connect individual output relay contact wiring to terminals 1...46 as indicated in [Wiring Connections for 5094-0W4IS and 5094-0W4ISXT on page 9](#). The even-numbered terminals are one pole of the relay contacts; the odd-numbered terminals are the other pole of the relay contacts.
5. Connect +V DC power to terminal SA+ on the left side of the terminal base.
6. Connect V DC common to terminal SA- on the left side of the terminal base.
7. If daisy-chaining +V DC power to the next terminal base, connect a jumper from terminal SA+ on the right side of this terminal base to terminal SA+ on the left side of the next terminal base.
8. If continuing V DC common to the next terminal base, connect a jumper from terminal SA- on the right side of this terminal base to terminal SA- on the left side of the next terminal base.

Disconnect Wires from the Terminal Base



WARNING: If you connect or disconnect wiring while power is applied, an electric arc can occur. This could cause an **explosion** in hazardous location installations. Be sure that power is removed or the area is nonhazardous before proceeding.

Disconnect wires from the terminal base.

TB Type	Action
Screw	<ol style="list-style-type: none"> 1. Turn the screwdriver counter-clockwise to open the terminal. 2. Remove the wire.
Spring	<ol style="list-style-type: none"> 1. Insert and hold a screwdriver in the slot above the terminal. 2. Remove the wire. 3. Pull out the screwdriver.

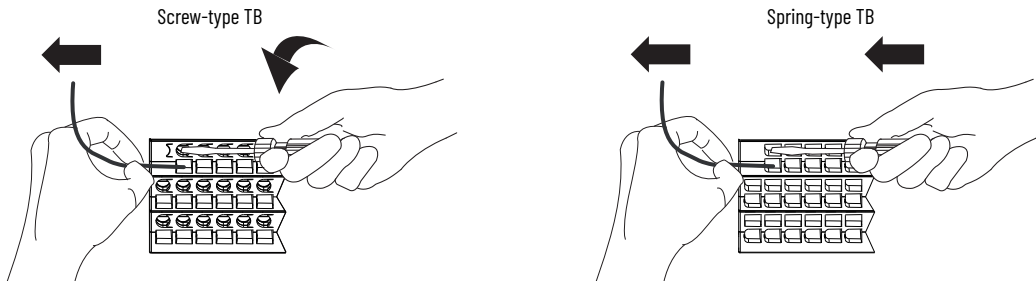

Wiring Diagram



ATTENTION: When you are using the relay to drive DC/AC inductive load, you must connect a snubber across the load. Failure to connect a snubber across the load (relay contacts) can result in generation of electromagnetic noise that could disrupt nearby electrical equipment, including your FLEX 5000 I/O chassis. See the Industrial Automation Wiring and Grounding Guidelines, publication [1770-4.1](#)

[Figure 1](#) is an example wiring diagram. The example applies to the 5094-0W4IS and 5094-0W4ISXT safety relay output modules. You must connect a 24V DC power source to the left SA+/- terminals to provide field-side power.

Figure 1 - Example 5094-0W4IS and 5094-0W4ISXT Wiring Diagram

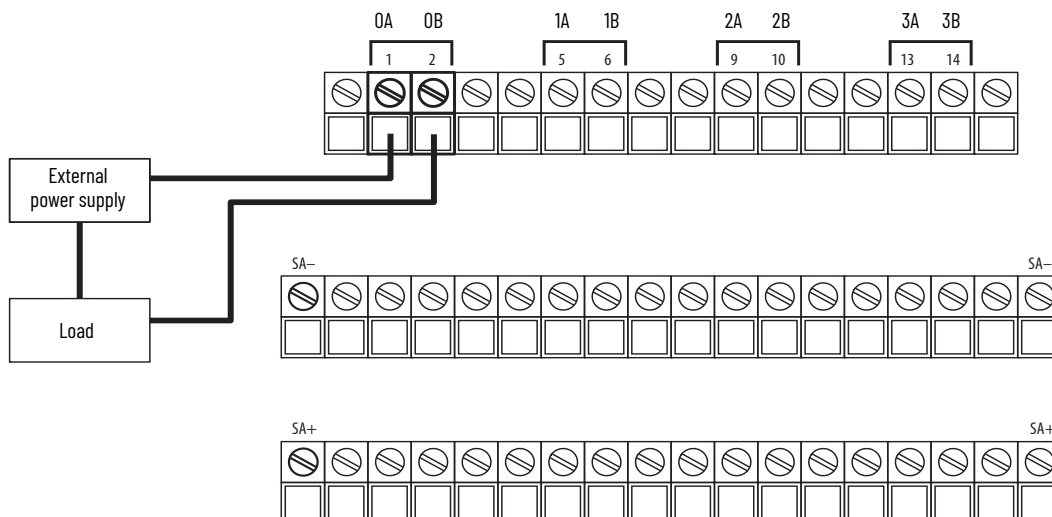

Table 1 - Wiring Connections for 5094-0W4IS and 5094-0W4ISXT

Output	Output Terminal
Even-numbered terminal = One contact of the relay Odd-numbered terminal = The other contact of the relay	
Relay 0	1
	2
Relay 1	5
	6
Relay 2	9
	10
Relay 3	13
	14
V DC common	SA-
+V DC power	SA+

Power the System

After you install all FLEX 5000 I/O modules, you can turn on power to the FLEX 5000 EtherNet/IP adapter and, if used, field-side power to the terminal bases. For more information, see [System Power Considerations on page 6](#).

Remove the Module



WARNING: When you insert or remove the module while backplane power or SA power (field-side) is On, an electric arc can occur. This could cause an **explosion** in hazardous location installations. Be sure that power is removed or the area is nonhazardous before proceeding. Repeated electric arcing causes excessive wear to contacts on both the module and its mating connector. Worn contacts may create electrical resistance that can affect module operation.

Catalog numbers 5094-0W4IS and 5094-0W4ISXT support Removal and Insertion Under Power (RIUP).

1. Press and hold the release lever on the top of the module.
Be sure to press the entire lever evenly.

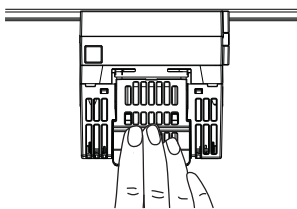
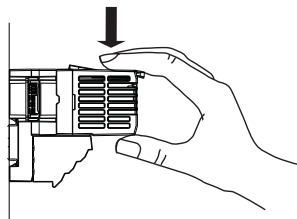

2. Pull the module off the terminal base.

Replace the Module

To replace the module, follow the steps that are described beginning with [Install the Module on page 6](#).

Module Specifications

[Table 2](#) lists a subset of the module specifications. For a complete list of specifications, see the FLEX 5000 Module Specifications Technical Data, publication [5094-TD001](#).

Table 2 - 5094-0W4IS and 5094-0W4ISXT Relay 4-point Safety Output Module Specifications

Attribute	5094-0W4IS, 5094-0W4ISXT
Temperature, operating IEC 60068-2-1 (Test Ad, Operating Cold), IEC 60068-2-2 (Test Bd, Operating Dry Heat), IEC 60068-2-14 (Test Nb, Operating Thermal Shock)	-40 °C ≤ T ≤ +70 °C (-40 °F ≤ Ta ≤ +158 °F)
Temperature, surrounding air, max	70 °C (158 °F)
Enclosure type rating	None (open-style)
Output ratings (OUT), max	5...30V DC, 2A/channel 5...30V DC, 4A/channel (channel 0 & 1 only, 2 & 3 unused) 125/240V AC, 50/60 Hz, 2A/channel
Expected contact life	100K cycles @ 2 A resistive load 50K cycles @ 4 A resistive load
Sensor Actuator (SA) power, max	125 mA @ 18...32V DC

Table 2 - 5094-OW4IS and 5094-OW4ISXT Relay 4-point Safety Output Module Specifications (Continued)

Attribute	5094-OW4IS, 5094-OW4ISXT
Isolation voltage	250V (continuous) Basic Insulation, SA Power to Backplane Reinforced Insulation, Channel to Channel
Wire category ⁽¹⁾	1 - signal ports 2 - power ports
Wire size and type	0.34...2.5 mm ² (22...14 AWG) solid or stranded copper wire rated at 105 °C (221 °F) or greater, 1.2 mm (3/64 in.) insulation max Ferrule according to DIN 46 228/1
TB keying	2 3 3
TB torque specifications	Screw-type TB: 0.4 N•m (3.5 lb•in) Spring-type TB: Not applicable
Insulation stripping length, TB	Screw-type TB: <ul style="list-style-type: none"> 0.34...2.5 mm² (22...14 AWG) = 12 ± 1 mm (0.47 ± 0.04 in.) Other = 12 ± 1 mm (0.47 ± 0.04 in.) Spring-type TB: <ul style="list-style-type: none"> 0.34...1.3 mm² (22...16 AWG) = 10 ± 1 mm (0.39 ± 0.04 in.) 1.5 mm² (15 AWG) = 15 ± 1 mm (0.59 ± 0.04 in.) Other = 10 ± 1 mm (0.39 ± 0.04 in.)
Terminal base	IMPORTANT: Mounting bases (MBs) and removable terminal bases (RTBs) do not ship with the FLEX 5000 I/O modules. You must purchase the MB and RTB individually for each I/O module. 5094-MB plus 5094-RTB3W (referred to in documentation as a non-orderable 5094-TB3W) 5094-MB plus 5094-RTB3WS (referred to in documentation as a non-orderable 5094-TB3WS) 5094-MBXT plus 5094-RTB3WXT (referred to in documentation as a non-orderable 5094-TB3WXT) 5094-MBXT plus 5094-RTB3WSXT (referred to in documentation as a non-orderable 5094-TB3WSXT)
Pilot duty rating	5...240V AC, 50/60 Hz, C300 pilot duty per channel 5...125V DC, R150 pilot duty per channel
Corrosion resistance classification	5094-OW4IS – ISA 71.04 G2 5094-OW4ISXT – ISA 71.04 G3
North American temp code	T4
UKEX/ATEX temp code	T4
IECEX temp code	T4
Safety Integrity Level	SIL 3, PLe, Cat. 4 (conditions apply), acc. IEC61508

(1) Use this Conductor Category information for planning conductor routing. See the Industrial Automation Wiring and Grounding Guidelines, publication 1770-4.1. Use this Conductor Category information for planning conductor routing as described in the appropriate System Level Installation Manual.

Additional Resources

For more information on the products that are described in this publication, use these resources. You can view or download publications at rok.auto/literature.

Resource	Description
FLEX 5000 Module Specifications Technical Data, publication 5094-TD001	Provides FLEX 5000 EtherNet/IP adapters and FLEX 5000 I/O module specifications.
FLEX 5000 Standard and Safety I/O Modules User Manual, publication 5094-UM001	Describes how to install, configure, and operate the FLEX 5000 digital standard and digital safety I/O modules.
FLEX 5000 EtherNet/IP Adapters with RJ45 Ports Installation Instructions, publication 5094-IN001	Describes how to install and wire the 5094-AENR, 5094-AENRXT, 5094-AEN2TR, and 5094-AEN2TRXT EtherNet/IP adapters.
FLEX 5000 Terminal Base Assembly Modules Installation Instructions, publication 5094-IN010	Describes how to install and wire the terminal base assemblies for the FLEX 5000 system.
Industrial Automation Wiring and Grounding Guidelines, publication 1770-4.1	Provides general guidelines for installing a Rockwell Automation industrial system.
Product Certifications website, rok.auto/certifications	Provides declarations of conformity, certificates, and other certification details.

Notes:

Rockwell Automation Support

Use these resources to access support information.

Technical Support Center	Find help with how-to videos, FAQs, chat, user forums, Knowledgebase, and product notification updates.	rok.auto/support
Local Technical Support Phone Numbers	Locate the telephone number for your country.	rok.auto/phonesupport
Technical Documentation Center	Quickly access and download technical specifications, installation instructions, and user manuals.	rok.auto/techdocs
Literature Library	Find installation instructions, manuals, brochures, and technical data publications.	rok.auto/literature
Product Compatibility and Download Center (PCDC)	Download firmware, associated files (such as AOP, EDS, and DTM), and access product release notes.	rok.auto/pcdc

Documentation Feedback

Your comments help us serve your documentation needs better. If you have any suggestions on how to improve our content, complete the form at rok.auto/docfeedback.





Waste Electrical and Electronic Equipment (WEEE)



At the end of life, this equipment should be collected separately from any unsorted municipal waste.

Rockwell Automation maintains current product environmental compliance information on its website at rok.auto/pec.

Rockwell Otomasyon Ticaret A.Ş. Kar Plaza İş Merkezi E Blok Kat:6 34752 İçerenköy, İstanbul, Tel: +90 (216) 5698400 EEE Yönetmeliğine Uygundur

Connect with us.    

rockwellautomation.com — expanding **human possibility**[®]

AMERICAS: Rockwell Automation, 1201 South Second Street, Milwaukee, WI 53204-2496 USA, Tel: (1) 414.382.2000

EUROPE/MIDDLE EAST/AFRICA: Rockwell Automation NV, Pegasus Park, De Kleetlaan 12a, 1831 Diegem, Belgium, Tel: (32) 2663 0600

ASIA PACIFIC: Rockwell Automation SEA Pte Ltd, 2 Corporation Road, #04-05, Main Lobby, Corporation Place, Singapore 618494, Tel: (65) 6510 6608

UNITED KINGDOM: Rockwell Automation Ltd., Pitfield, Kiln Farm, Milton Keynes, MK11 3DR, United Kingdom, Tel: (44)(1908) 838-800

Allen-Bradley, expanding human possibility, FactoryTalk, FLEX 5000, GuardLogix, Logix 5000, Rockwell Automation, Studio 5000 Logix Designer, and TechConnect are trademarks of Rockwell Automation, Inc.

EtherNet/IP is a trademark of ODVA, Inc.

Trademarks not belonging to Rockwell Automation are property of their respective companies

Publication 5094-IN015D-EN-P - September 2025 | Supersedes Publication 5094-IN015C-EN-P - April 2023

Copyright © 2025 Rockwell Automation, Inc. All rights reserved. Printed in Singapore.

PN-738906