

Installation Instructions

Original Instructions



Allen-Bradley

by ROCKWELL AUTOMATION

Compact 5000 I/O Address Reserve Module

Catalog Number 5069-ARM

Topic	Page
About the Module	4
Install a System	5
Install the Module	6
Install the End Cap	6
Power the System	6
Remove the Module	7
Specifications	7
Additional Resources	8

The 5069-ARM address reserve module reserves a node address in a CompactLogix® 5380, CompactLogix 5480, or Compact GuardLogix® 5380 control system or Compact 5000® I/O system. The module remains installed until you insert another Compact 5000 I/O module into the same location.

Summary of Changes

This publication contains new and updated information as indicated in the following table.

Topic	Page
Updated the UK and European, and IEC hazardous location approval information	3
Updated the Temperature, operating, SA power, and SA power (passthrough) specifications	7
Added UKEX to the ATEX specification	7



ATTENTION: Read this document and the documents listed in the Additional Resources section about installation, configuration and operation of this equipment before you install, configure, operate or maintain this product. Users are required to familiarize themselves with installation and wiring instructions in addition to requirements of all applicable codes, laws, and standards.

Activities including installation, adjustments, putting into service, use, assembly, disassembly, and maintenance are required to be carried out by suitably trained personnel in accordance with applicable code of practice. If this equipment is used in a manner not specified by the manufacturer, the protection provided by the equipment may be impaired.

注意: 在安裝、配置、操作和維護本產品前，請閱讀本文檔以及“其他資源”部分列出的有關設備安裝、配置和操作的相應文檔。除了所有適用規範、法律和標準的相關要求之外，用戶還必須熟悉安裝和接線說明。

安裝、調整、搬運、使用、組裝、拆卸和維護等各項操作必須由經過適當訓練的專業人員按照適用的操作規範實施。

如果未按照製造商指定的方式使用該設備，則可能會損害設備提供的保護。

ATENCIÓN: Antes de instalar, configurar, poner en funcionamiento o realizar el mantenimiento de este producto, lea este documento y los documentos listados en la sección Recursos adicionales acerca de la instalación, configuración y operación de este equipo. Los usuarios deben familiarizarse con las instrucciones de instalación y cableado y con los requisitos de todos los códigos, leyes y estándares vigentes.

El personal debidamente capacitado debe realizar las actividades relacionadas a la instalación, ajustes, puesta en servicio, uso, ensamblaje, desensamblaje y mantenimiento de conformidad con el código de práctica aplicable. Si este equipo se usa de una manera no especificada por el fabricante, la protección provista por el equipo puede resultar afectada.

ATENÇÃO: Leia este e os demais documentos sobre instalação, configuração e operação do equipamento que estão na seção Recursos adicionais antes de instalar, configurar, operar ou manter este produto. Os usuários devem se familiarizar com as instruções de instalação e fiação além das especificações para todos os códigos, leis e normas aplicáveis.

É necessário que as atividades, incluindo instalação, ajustes, colocação em serviço, utilização, montagem, desmontagem e manutenção sejam realizadas por pessoal qualificado e especializado, de acordo com o código de prática aplicável.

Caso este equipamento seja utilizado de maneira não estabelecida pelo fabricante, a proteção fornecida pelo equipamento pode ficar prejudicada.

ВНИМАНИЕ: Перед тем как устанавливать, настраивать, эксплуатировать или обслуживать данное оборудование, прочитайте этот документ и документы, перечисленные в разделе «Дополнительные ресурсы». В этих документах изложены сведения об установке, настройке и эксплуатации данного оборудования. Пользователи обязаны ознакомиться с инструкциями по установке и прокладке соединений, а также с требованиями всех применимых норм, законов и стандартов.

Все действия, включая установку, наладку, ввод в эксплуатацию, использование, сборку, разборку и техническое обслуживание, должны выполняться обученным персоналом в соответствии с применимыми нормами и правилами.

Если оборудование используется не предусмотренным производителем образом, защита оборудования может быть нарушена.

注意: 本製品を設置、構成、稼働または保守する前に、本書および本機器の設置、設定、操作についての参考資料の該当箇所に記載されている文書に目を通してください。ユーザは、すべての該当する条例、法律、規格の要件に加えて、設置および配線の手順に習熟している必要があります。

設置調整、運転の開始、使用、組立て、解体、保守を含む諸作業は、該当する実施規則に従って訓練を受けた適切な作業員が実行する必要があります。

本機器が製造メーカーにより指定されていない方法で使用されている場合、機器により提供されている保護が損なわれる恐れがあります。

ACHTUNG: Lesen Sie dieses Dokument und die im Abschnitt „Weitere Informationen“ aufgeführten Dokumente, die Informationen zu Installation, Konfiguration und Bedienung dieses Produkts enthalten, bevor Sie dieses Produkt installieren, konfigurieren, bedienen oder warten. Anwender müssen sich neben den Bestimmungen aller anwendbaren Vorschriften, Gesetze und Normen zusätzlich mit den Installations- und Verdrahtungsanweisungen vertraut machen.

Arbeiten im Rahmen der Installation, Anpassung, Inbetriebnahme, Verwendung, Montage, Demontage oder Instandhaltung dürfen nur durch ausreichend geschulte Mitarbeiter und in Übereinstimmung mit den anwendbaren Ausführungsvorschriften vorgenommen werden.

Wenn das Gerät in einer Weise verwendet wird, die vom Hersteller nicht vorgesehen ist, kann die Schutzfunktion beeinträchtigt sein.

ATTENTION: Lisez ce document et les documents listés dans la section Ressources complémentaires relatifs à l'installation, la configuration et le fonctionnement de cet équipement avant d'installer, configurer, utiliser ou entretenir ce produit. Les utilisateurs doivent se familiariser avec les instructions d'installation et de câblage en plus des exigences relatives aux codes, lois et normes en vigueur. Les activités relatives à l'installation, le réglage, la mise en service, l'utilisation, l'assemblage, le démontage et l'entretien doivent être réalisées par des personnes formées selon le code de pratique en vigueur.

Si cet équipement est utilisé d'une façon qui n'a pas été définie par le fabricant, la protection fournie par l'équipement peut être compromise.

주의: 본 제품 설치, 설정, 작동 또는 유지 보수하기 전에 본 문서를 포함하여 설치, 설정 및 작동에 관한 참고 자료 섹션의 문서들을 반드시 읽고 숙지하십시오. 사용자는 모든 관련 규정, 법규 및 표준에서 요구하는 사항에 대해 반드시 설치 및 배선 지침을 숙지해야 합니다.

설치, 조정, 가동, 사용, 조립, 분해, 유지보수 등 모든 작업은 관련 규정에 따라 적절한 교육을 받은 사용자가 통해서만 수행해야 합니다.

본 장비를 제조사가 명시하지 않은 방법으로 사용하면 장비의 보호 기능이 손상될 수 있습니다.

ATTENZIONE: Prima di installare, configurare ed utilizzare il prodotto, o effettuare interventi di manutenzione su di esso, leggere il presente documento ed i documenti elencati nella sezione "Altre risorse", riguardanti l'installazione, la configurazione ed il funzionamento dell'apparecchiatura. Gli utenti devono leggere e comprendere le istruzioni di installazione e cablaggio, oltre ai requisiti previsti dalle leggi, codici e standard applicabili.

Le attività come installazione, regolazioni, utilizzo, assemblaggio, disassemblaggio e manutenzione devono essere svolte da personale adeguatamente addestrato, nel rispetto delle procedure previste. Qualora l'apparecchio venga utilizzato con modalità diverse da quanto previsto dal produttore, la sua funzione di protezione potrebbe venire compromessa.

DİKKAT: Bu ürünün kurulumu, yapılandırılması, işletilmesi veya bakımı öncesinde bu dokümanı ve bu ekipmanın kurulumu, yapılandırılması ve işletimi ile ilgili ilave Kaynaklar bölümünde yer listelenmiş dokümanları okuyun. Kullanıcılar yürürlükteki tüm yönetmelikler, yasalar ve standartların gereksinimlerine ek olarak kurulum ve kablolama talimatlarını da öğrenmek zorundadır.

Kurulum, ayarlama, hizmete alma, kullanma, parçaları birleştirme, parçaları sökme ve bakım gibi aktiviteler sadece uygun eğitimleri almış kişiler tarafından yürürlükteki uygulama yönetmeliklerine uygun şekilde yapılabilir.

Bu ekipman üretici tarafından belirlenmiş amacın dışında kullanılırsa, ekipman tarafından sağlanan koruma bozulabilir.

注意事項: 在安裝、設定、操作或維護本產品前，請先閱讀此文件以及列於「其他資源」章節中有關安裝、設定與操作此設備的文件。使用者必須熟悉安裝和配線指示，並符合所有法規、法律和標準要求。

包括安裝、調整、交付使用、使用、組裝、拆卸和維護等動作都必須交由已經適當訓練的人員進行，以符合適用的實作法規。

如果將設備用於非製造商指定的用途時，可能會造成設備所提供的保護功能受損。

POZOR: Než začnete instalovat, konfigurovat či provozovat tento výrobek nebo provádět jeho údržbu, přečtěte si tento dokument a dokumenty uvedené v části Dodatečné zdroje ohledně instalace, konfigurace a provozu tohoto zařízení. Uživatelé se musejí vedle požadavků všech relevantních vyhlášek, zákonů a norem nutně seznámit také s pokyny pro instalaci a elektrické zapojení.

Činnosti zahrnující instalaci, nastavení, uvedení do provozu, užívání, montáž, demontáž a údržbu musí vykonávat vhodné proškolený personál v souladu s příslušnými prováděcími předpisy.

Pokud se toto zařízení používá způsobem neodpovídajícím specifikaci výrobce, může být narušena ochrana, kterou toto zařízení poskytuje.

UWAGA: Przed instalacją, konfiguracją, użytkowaniem lub konserwacją tego produktu należy przeczytać niniejszy dokument oraz wszystkie dokumenty wymienione w sekcji Dodatkowe źródła omawiające instalację, konfigurację i procedury użytkowania tego urządzenia. Użytkownicy mają obowiązek zapoznać się z instrukcjami dotyczącymi instalacji oraz oprzewodowania, jak również z obowiązującymi kodeksami, prawem i normami.

Działania obejmujące instalację, regulację, przekazanie do użytkowania, użytkowanie, montaż, demontaż oraz konserwację muszą być wykonywane przez odpowiednio przeszkolony personel zgodnie z obowiązującym kodeksem postępowania.

Jeśli urządzenie jest użytkowane w sposób inny niż określony przez producenta, zabezpieczenie zapewniane przez urządzenie może zostać ograniczone.

OBBS: Läs detta dokument samt dokumentet, som står listat i avsnittet Övriga resurser, om installation, konfigurering och drift av denna utrustning innan du installerar, konfigurerar eller börjar använda eller utföra underhållsarbete på produkten. Användare måste bekanta sig med instruktioner för installation och kabeldragning, förutom krav enligt gällande koder, lagar och standarder.

Åtgärder som installation, justering, service, användning, montering, demontering och underhållsarbete måste utföras av personal med lämplig utbildning enligt lämpligt bruk.



Om denna utrustning används på ett sätt som inte anges av tillverkaren kan det hända att utrustningens skyddsanordningar försätts ur funktion.

LET OP: Lees dit document en de documenten die genoemd worden in de paragraaf Aanvullende informatie over de installatie, configuratie en bediening van deze apparatuur voordat u dit product installeert, configureert, bedient of onderhoudt. Gebruikers moeten zich vertrouwd maken met de installatie en de bedringsinstructies, naast de vereisten van alle toepasselijke regels, wetten en normen.

Activiteiten zoals het installeren, afstellen, in gebruik stellen, gebruiken, monteren, demonteren en het uitvoeren van onderhoud mogen uitsluitend worden uitgevoerd door hiervoor opgeleid personeel en in overeenstemming met de geldende praktijkregels.

Indien de apparatuur wordt gebruikt op een wijze die niet is gespecificeerd door de fabrikant, dan bestaat het gevaar dat de beveiliging van de apparatuur niet goed werkt.

North American Hazardous Location Approval

The following information applies when operating this equipment in hazardous locations.	Informations sur l'utilisation de cet équipement en environnements dangereux.
<p>Products marked "CL I, DIV 2, GP A, B, C, D" are suitable for use in Class I Division 2 Groups A, B, C, D, Hazardous Locations and nonhazardous locations only. Each product is supplied with markings on the rating nameplate indicating the hazardous location temperature code. When combining products within a system, the most adverse temperature code (lowest "T" number) may be used to help determine the overall temperature code of the system. Combinations of equipment in your system are subject to investigation by the local Authority Having Jurisdiction at the time of installation.</p>	<p>Les produits marqués "CL I, DIV 2, GP A, B, C, D" ne conviennent qu'à une utilisation en environnements de Classe I Division 2 Groupes A, B, C, D dangereux et non dangereux. Chaque produit est livré avec des marquages sur sa plaque d'identification qui indiquent le code de température pour les environnements dangereux. Lorsque plusieurs produits sont combinés dans un système, le code de température le plus défavorable (code de température le plus faible) peut être utilisé pour déterminer le code de température global du système. Les combinaisons d'équipements dans le système sont sujettes à inspection par les autorités locales qualifiées au moment de l'installation.</p>
<p> WARNING: Explosion Hazard -</p> <ul style="list-style-type: none"> Do not disconnect equipment unless power has been removed or the area is known to be nonhazardous. Do not disconnect connections to this equipment unless power has been removed or the area is known to be nonhazardous. Secure any external connections that mate to this equipment by using screws, sliding latches, threaded connectors, or other means provided with this product. Substitution of components may impair suitability for Class I, Division 2. If this product contains batteries, they must only be changed in an area known to be nonhazardous. 	<p> AVERTISSEMENT: Risque d'Explosion -</p> <ul style="list-style-type: none"> Couper le courant ou s'assurer que l'environnement est classé non dangereux avant de débrancher l'équipement. Couper le courant ou s'assurer que l'environnement est classé non dangereux avant de débrancher les connecteurs. Fixer tous les connecteurs externes reliés à cet équipement à l'aide de vis, loquets coulissants, connecteurs filetés ou autres moyens fournis avec ce produit. La substitution de composants peut rendre cet équipement inadapté à une utilisation en environnement de Classe I, Division 2. S'assurer que l'environnement est classé non dangereux avant de changer les piles.

UK and European Hazardous Location Approval

<p>The following applies to products marked  II 3 G.</p> <ul style="list-style-type: none"> Are Equipment Group II, Equipment Category 3, and comply with the Essential Health and Safety Requirements relating to the design and construction of such equipment that is given in Schedule 1 of UKEX Regulation 2016 No. 1107 and Annex II of EU Directive 2014/34/EU. See the UKEX and EU Declaration of Conformity at rok.auto/certifications for details. The type of protection is "Ex ec IIC T4 Gc" according to EN IEC 60079-0:2018, EXPLOSIVE ATMOSPHERES - PART 0: EQUIPMENT - GENERAL REQUIREMENTS, Issue Date 07/2018 and CENELEC EN IEC 60079-7:2015+A1:2018, Explosive atmospheres. Equipment protection by increased safety "e". Comply with Standard EN IEC 60079-0:2018, EXPLOSIVE ATMOSPHERES - PART 0: EQUIPMENT - GENERAL REQUIREMENTS, Issue Date 07/2018, CENELEC EN IEC 60079-7:2015+A1:2018 Explosive atmospheres. Equipment protection by increased safety "e", reference certificate number DEMKO 15 ATEX 1455X and UL22UKEX2307X. Are intended for use in areas in which explosive atmospheres caused by gases, vapors, mists, or air are unlikely to occur, or are likely to occur only infrequently and for short periods. Such locations correspond to Zone 2 classification according to UKEX regulation 2016 No. 1107 and ATEX directive 2014/34/EU.

IEC Hazardous Location Approval

<p>The following applies to products with IECEx certification:</p> <ul style="list-style-type: none"> Are intended for use in areas in which explosive atmospheres caused by gases, vapors, mists, or air are unlikely to occur, or are likely to occur only infrequently and for short periods. Such locations correspond to Zone 2 classification to IEC 60079-0. The type of protection is "Ex ec IIC T4 Gc" according to IEC 60079-0 and IEC 60079-7. Comply with Standards IEC 60079-0, Explosive atmospheres - Part 0: Equipment -General requirements, Edition 7, Revision Date 2017, IEC 60079-7, 5.1 Edition revision date 2017, Explosive atmospheres - Part 7: Equipment protection by increased safety "e", reference IECEx certificate number IECExUL15.0007X.
--

Environment and Enclosure

<p> ATTENTION: This equipment is intended for use in a Pollution Degree 2 industrial environment, in overvoltage Category II applications (as defined in EN/IEC 60664-1), at altitudes up to 2000 m (6562 ft) without derating.</p> <p>This equipment is not intended for use in residential environments and does not provide adequate protection to radio communication services in such environments.</p> <p>This equipment is supplied as open-type equipment for indoor use. It must be mounted within an enclosure that is suitably designed for those specific environmental conditions that are present and appropriately designed to help prevent personal injury that result from accessibility to live parts. The enclosure must have suitable flame-retardant properties to help prevent or minimize the spread of flame, which complies with a flame spread rating of 5VA or be approved for the application if nonmetallic. The interior of the enclosure must be accessible only by the use of a tool. Subsequent sections of this publication can contain more information regarding specific enclosure type ratings that are required to comply with certain product safety certifications.</p> <p>Also see the following:</p> <ul style="list-style-type: none"> Publication 1770-4.1 for more installation requirements. NEMA STANDARD 250 and EN/IEC 60529, as applicable, for explanations of the degrees of protection provided by enclosures.
--

Special Conditions for Safe Use



WARNING:

- This equipment must be mounted in an UKEX/ATEX/IECEX Zone 2 certified enclosure with a minimum ingress protection rating of at least IP54 (as defined in EN/IEC 60079-0) and used in an environment of not more than Pollution Degree 2 (as defined in EN/IEC 60664-1) when applied in Zone 2 environments. The enclosure must be accessible only by the use of a tool.
- This equipment must be used within its specified ratings that Rockwell Automation defines.
- Transient protection must be provided that is set at a level not to exceed 140% of the peak rated voltage at the supply terminals to the equipment.
- The instructions in the user manual must be observed.
- This equipment must be used only with UKEX/ATEX/IECEX certified Rockwell Automation backplanes.
- Secure any external connections that mate to this equipment by using screws, sliding latches, threaded connectors, or other means provided with this product.
- Do not disconnect equipment unless power has been removed or the area is known to be nonhazardous.
- Earthing is accomplished through the mounting of modules on the rail.

Help Prevent Electrostatic Discharge



ATTENTION: This equipment is sensitive to electrostatic discharge, which can cause internal damage and affect normal operation. Follow these guidelines when you handle this equipment:

- Touch a grounded object to discharge potential static.
- Wear an approved grounding wriststrap.
- Do not touch connectors or pins on component boards.
- Do not touch circuit components inside the equipment.
- Use a static-safe workstation, if available.
- Store the equipment in appropriate static-safe packaging when not in use.

Electrical Safety Considerations



ATTENTION:

- If malfunction or damage is present, no attempts at repair must be made. The module must be returned to the manufacturer for repair. Do not dismantle the module.
- This equipment is certified for use only within the surrounding air temperature range of 0...60 °C (32...140 °F). The equipment must not be used outside of this range.
- Use only a soft dry anti-static cloth to wipe down equipment. Do not use any cleaning agents.

IMPORTANT

Any illustrations, charts, sample programs, and layout examples that are shown in this publication are intended solely for the purposes of an example. Since there are many variables and requirements that are associated with any particular installation, Rockwell Automation does not assume responsibility or liability for actual use that is based on the examples that are shown in this publication.

About the Module

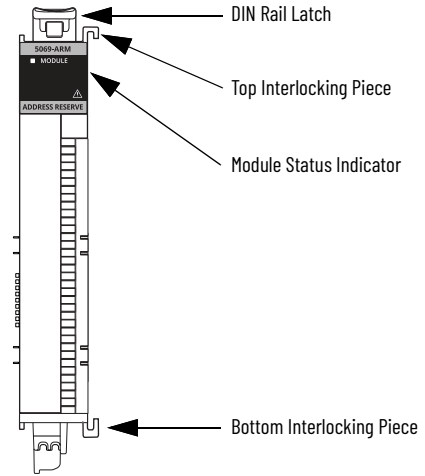

Side View

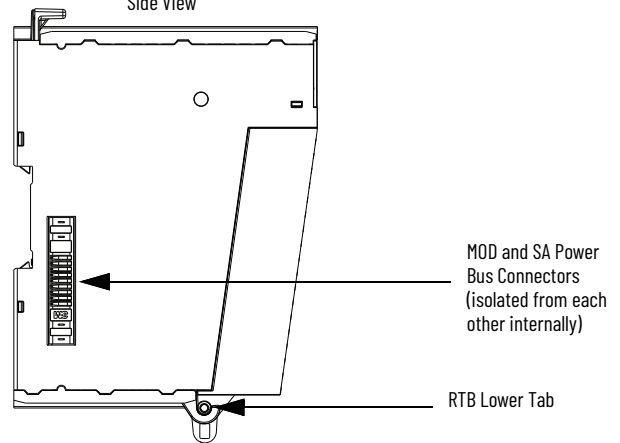

Install a System

Based on your application design, you must install a CompactLogix 5380 controller or Compact 5000 I/O EtherNet/IP™ adapter before you can install the 5069-ARM address reserve module.

For more information on how to install these components, see the publications that are listed in the [Additional Resources on page 8](#).

Dimensions

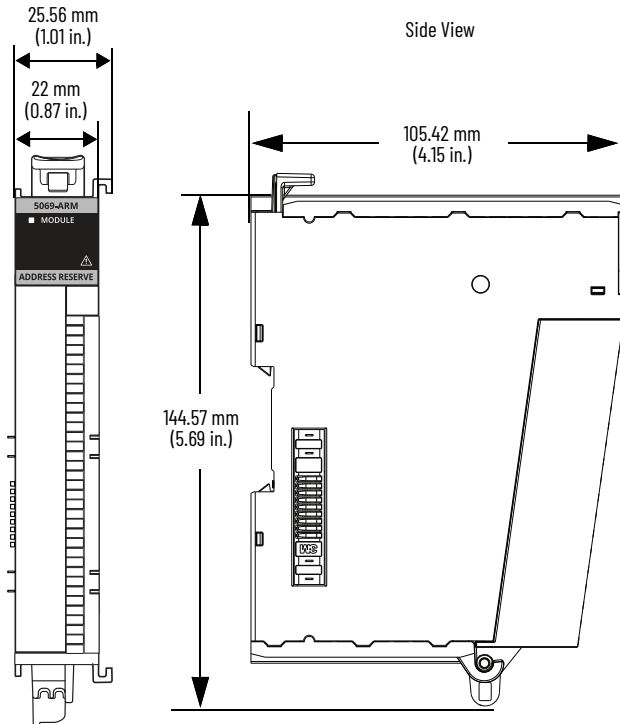

Ground Considerations

Use the EN50022 - 35 x 7.5 mm (1.38 x 0.30 in.) DIN rail with Compact 5000 I/O modules.



ATTENTION: This product is grounded through the DIN rail to chassis ground. Use zinc-plated yellow-chromate steel DIN rail to assure proper grounding. The use of other DIN rail materials (for example, aluminum or plastic) that can corrode, oxidize, or are poor conductors, can result in improper or intermittent grounding. Secure the DIN rail to the mounting surface approximately every 200 mm (7.8 in.) and use end-anchors appropriately. Be sure to ground the DIN rail properly. See publication [1770-4.1](#) for more information.

System Power Considerations

A CompactLogix 5380 controller or Compact 5000 I/O adapter provides power to a system.

The following power types are available:

- **Module (MOD) power** - System-side power that is required to operate the Compact 5000 I/O system. MOD power is provided through the MOD power RTB and passed across the MOD power bus.
- **Sensor actuator (SA) power** - Field-side power that is used to power field-side devices. SA power is provided through the SA power RTB and passed across the SA power bus.

A system can have multiple SA power buses. You use 5069-FPD field potential distributors to establish a new SA power bus. SA power buses are isolated from each other.

The 5069-ARM address reserve module does not use SA power.

IMPORTANT We recommend that you use separate external power supplies for MOD power and SA power, respectively. This practice can help prevent unintended consequences that can result if you use one supply.

If you use separate external power supplies, the loss of power from one external power supply does not affect the availability of power from the other supply. For example, if separate external power supplies are used and SA power is lost, MOD power remains available for the Compact 5000 I/O modules.

For more information on MOD power and SA power, see the publications that are listed in the [Additional Resources on page 8](#).

Install the Module

You can install a 5069-ARM address reserve module next to any Compact 5000 I/O module.



WARNING: If you insert or remove the module while backplane power is on, an electric arc can occur. This arc could cause an explosion in hazardous location installations.

The module does not support "Removal and Insertion Under Power" (RIUP) capability. Do not connect or disconnect the module while power is applied. Be sure that power is removed before proceeding.

1. Confirm that MOD power and all sources of SA power are turned off.
If you remove the module with power applied, the MOD power bus and SA power bus are affected. For example, you can interrupt MOD power to the other modules in the system. Unintended consequences can occur as a result.
2. If an end cap is installed on the right-most module that is installed in the system, remove and keep it for later use.



ATTENTION: Do not discard the end cap. Use this end cap to cover the exposed interconnections on the last module on the DIN rail. Failure to do so could result in equipment damage or injury from electric shock.

3. Confirm that the DIN rail latch is closed.
4. If the DIN rail latches are open, gently push the rear latch back until the front latch pops up and clicks.

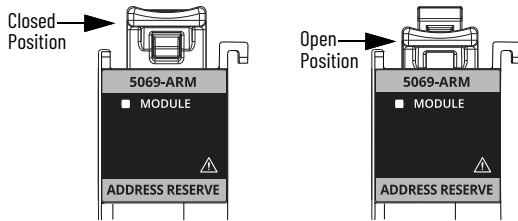

5. Align the interlocking pieces of the module with the device on the left. The top interlocking pieces engage first.
6. Push the module toward the DIN rail until a click indicates that the module is locked in place.

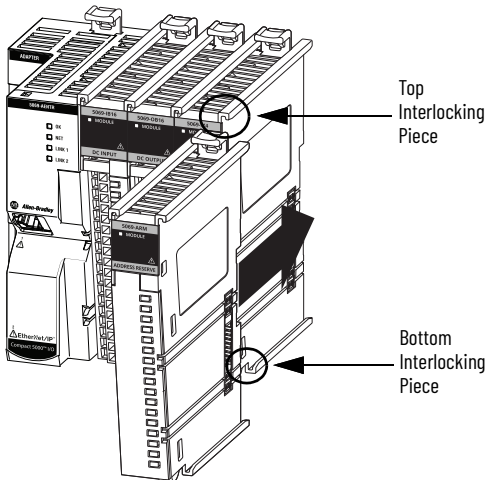

7. Verify that the module is installed in one of the following ways:
 - If the address reserve module is installed on the right side of a controller or adapter, the front of the address reserve module is set back slightly from the front of the controller or adapter.
Typically, the 5069-ARM address reserve module is not installed on the right side of a controller or adapter.
 - If you install the 5069-ARM address reserve module on the right side of a Compact 5000 I/O module, the fronts of the modules are flush.

Install the End Cap

You must install an end cap on the last module in your system. Typically, the 5069-ARM address reserve module is not the last module in the system.

IMPORTANT You install the end cap after the last module is installed on the DIN rail. This design helps to prevent the end cap from going beyond the locked position.

If you push the end cap beyond the locked position or insert it from the backwards direction, you can damage the MOD power bus and SA power bus connector.

1. Align the end cap with the interlocking pieces on the module.

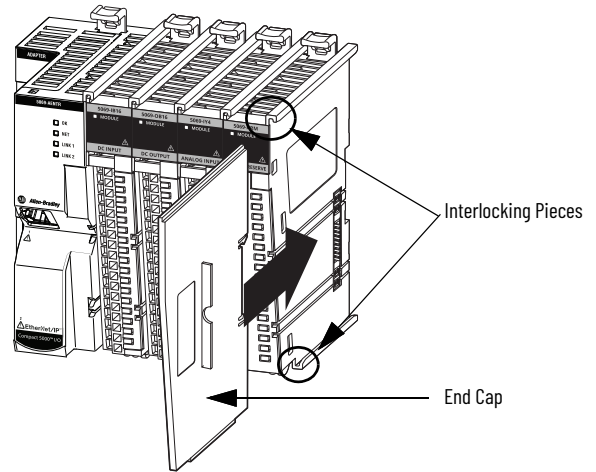

2. Push the end cap toward the DIN rail until it locks in place.

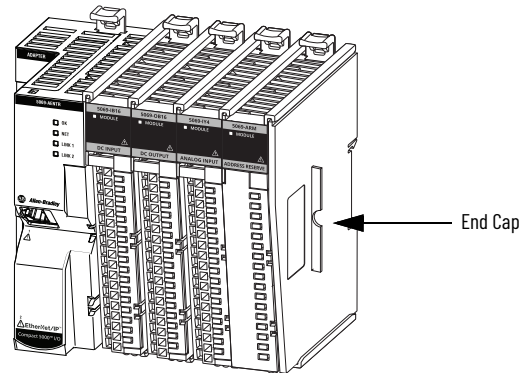

Power the System

After you install the Compact 5000 I/O modules, you can turn on MOD power and, if used, SA power to the system.

For more information on MOD power and SA power, see [System Power Considerations on page 5](#).

Remove the Module



ATTENTION: Do not remove or replace the module while power is applied. Interruption of the backplane can result in unintentional operation or machine motion.

1. Turn off MOD power and, if used, SA power to the system.

IMPORTANT Before you remove power MOD power and, if used, SA power, consider the effect on your system.

When you remove MOD power from the controller or adapter, you shut down power to all modules in the Compact 5000 I/O system. That is, all system-side is removed. When you remove SA power from a controller, adapter, or field potential distributor, all field-side power that is provided by that component is removed.

We strongly recommend that you take the appropriate actions to help prevent unintended consequences that can result from a system power shutdown before removing MOD power or SA power.

2. If necessary, remove the end cap from the module.
3. Press the DIN rail latch down until it clicks.

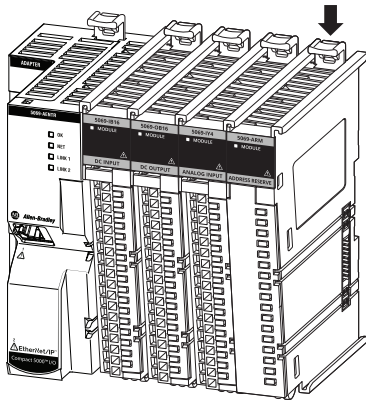

4. Pull the module off the DIN rail.

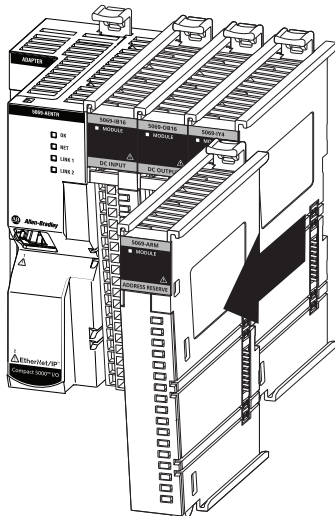

5. To replace the 5069-ARM address reserve module, see [Install the Module on page 6](#).

Specifications

The following table lists a subset of specifications for the 5069-ARM address reserve module. For a complete list of specifications, see publication [5069-TD001](#).

Attribute	5069-ARM
Temperature, operating IEC 60068-2-1 (Test Ad, operating cold), IEC 60068-2-2 (Test Bd, operating dry heat), IEC 60068-2-14 (Test Nb, operating thermal shock)	0 °C ≤ Ta ≤ +60 °C (+32 °F ≤ Ta ≤ +140 °F)
Temperature, surrounding air, max	60 °C (140 °F)
Voltage and current ratings	
MOD power	45 mA at 18...32V DC
MOD power (passthrough)	9.55 A at 18...32V DC
SA power (passthrough)	9.95 A at 0...32V DC 9.975 A at 0...240V AC, 47...63 Hz EX, 125V AC, max
Do not exceed 10 A MOD or SA power (passthrough) current draw	
Enclosure type rating	None (open-style)
North American temp code	T4
UKEX/ATEX temp code	T4
IECEx temp code	T4

Additional Resources

For more information on the products that are described in this publication, use these resources.

Resource	Description
CompactLogix 5380 and Compact GuardLogix 5380 Controllers User Manual, publication 5069-UM001	Describes how to use CompactLogix 5380 controllers.
Compact 5000 EtherNet/IP Adapters, publication 5069-UM007	Describes how to use Compact 5000 EtherNet/IP adapters in a Logix 5000™ control system.
Compact 5000 I/O Modules and EtherNet/IP Adapters Technical Data, publication 5069-TD001	Provides Compact 5000 I/O modules and EtherNet/IP adapters specifications.
System Security Design Guidelines Reference Manual, publication SECURE-RM001	Provides guidance on how to conduct security assessments, implement Rockwell Automation products in a secure system, harden the control system, manage user access, and dispose of equipment.
Industrial Automation Wiring and Grounding Guidelines, publication 1770-4.1	Provides general guidelines for installing a Rockwell Automation industrial system.
Product Certifications website, rok.auto/certifications	Provides declarations of conformity, certificates, and other certification details.

You can view or download publications at rok.auto/literature.

Rockwell Automation Support

Technical Support Center	Find help with how-to videos, FAQs, chat, user forums, and product notification updates.	rok.auto/support
Knowledgebase	Access Knowledgebase articles.	rok.auto/knowledgebase
Local Technical Support Phone Numbers	Locate the telephone number for your country.	rok.auto/phonesupport
Literature Library	Find installation instructions, manuals, brochures, and technical data publications.	rok.auto/literature
Product Compatibility and Download Center (PCDC)	Download firmware, associated files (such as AOP, EDS, and DTM), and access product release notes.	rok.auto/pcdc

Documentation Feedback

Your comments help us serve your documentation needs better. If you have any suggestions on how to improve our content, complete the form at rok.auto/docfeedback.





Waste Electrical and Electronic Equipment (WEEE)



At the end of life, this equipment should be collected separately from any unsorted municipal waste.

Rockwell Automation maintains current product environmental compliance information on its website at rok.auto/pec.

Rockwell Otomasyon Ticaret A.Ş. Kar Plaza İş Merkezi E Blok Kat:6 34752 İçerenköy, İstanbul, Tel: +90 (216) 5698400 EEE Yönetmeliğine Uygundur

Connect with us.    

rockwellautomation.com — expanding human possibility®

AMERICAS: Rockwell Automation, 1201 South Second Street, Milwaukee, WI 53204-2496 USA, Tel: (1) 414.382.2000

EUROPE/MIDDLE EAST/AFRICA: Rockwell Automation NV, Pegasus Park, De Kleetlaan 12a, 1831 Diegem, Belgium, Tel: (32) 2663 0600

ASIA PACIFIC: Rockwell Automation SEA Pte Ltd, 2 Corporation Road, #04-05, Main Lobby, Corporation Place, Singapore 618494, Tel: (65) 6510 6608

UNITED KINGDOM: Rockwell Automation Ltd., Pitfield, Kiln Farm, Milton Keynes, MK11 3DR, United Kingdom, Tel: (44)(1908) 838-800

Allen-Bradley, expanding human possibility, and Rockwell Automation are trademarks of Rockwell Automation, Inc.
Trademarks not belonging to Rockwell Automation are property of their respective companies.

Publication 5069-IN002E-EN-P - August 2024 | Supersedes Publication 5069-IN002D-EN-P - December 2021
Copyright © 2024 Rockwell Automation, Inc. All rights reserved. Printed in the U.S.A.

PN-688314