

Installation Instructions

Original Instructions



Allen-Bradley

by ROCKWELL AUTOMATION

FLEX I/O-XT Isolated Analog Input Module

Catalog Number 1794-IF4ICFXT

Topic	Page
Summary of Changes	1
Overview	5
Install Your Module	5
Wire Your Module	5
Configure Your Module	7
Status Indicator	9
Specifications	9
Additional Resources	11

Summary of Changes

This publication contains the following new or updated information. This list includes substantive updates only and is not intended to reflect all changes.

Topic	Page
Updated Certifications	11
Added Additional Resources	11



ATTENTION: Read this document and the documents listed in the Additional Resources section about installation, configuration and operation of this equipment before you install, configure, operate or maintain this product. Users are required to familiarize themselves with installation and wiring instructions in addition to requirements of all applicable codes, laws, and standards.

Activities including installation, adjustments, putting into service, use, assembly, disassembly, and maintenance are required to be carried out by suitably trained personnel in accordance with applicable code of practice. If this equipment is used in a manner not specified by the manufacturer, the protection provided by the equipment may be impaired.

注意：在安装、配置、操作和维护本产品前，请阅读本文档以及“其他资源”部分列出的有关设备安装、配置和操作的相应文档。除了所有适用规范、法律和标准的相关要求之外，用户还必须熟悉安装和接线说明。

安装、调整、投运、使用、组装、拆卸和维护等各项操作必须由经过适当训练的专业人员按照适用的操作规范实施。

如果未按照制造商指定的方式使用该设备，则可能会损害设备提供的保护。

ATENCIÓN: Antes de instalar, configurar, poner en funcionamiento o realizar el mantenimiento de este producto, lea este documento y los documentos listados en la sección Recursos adicionales acerca de la instalación, configuración y operación de este equipo. Los usuarios deben familiarizarse con las instrucciones de instalación y cableado y con los requisitos de todos los códigos, leyes y estándares vigentes. El personal debidamente capacitado debe realizar las actividades relacionadas a la instalación, ajustes, puesta en servicio, uso, ensamblaje, desensamblaje y mantenimiento de conformidad con el código de práctica aplicable. Si este equipo se usa de una manera no especificada por el fabricante, la protección provista por el equipo puede resultar afectada.

ATENÇÃO: Leia este e os demais documentos sobre instalação, configuração e operação do equipamento que estão na seção Recursos adicionais antes de instalar, configurar, operar ou manter este produto. Os usuários devem se familiarizar com as instruções de instalação e fiação além das especificações para todos os códigos, leis e normas aplicáveis.

É necessário que as atividades, incluindo instalação, ajustes, colocação em serviço, utilização, montagem, desmontagem e manutenção sejam realizadas por pessoal qualificado e especializado, de acordo com o código de prática aplicável.

Caso este equipamento seja utilizado de maneira não estabelecida pelo fabricante, a proteção fornecida pelo equipamento pode ficar prejudicada.

ВНИМАНИЕ: Перед тем как устанавливать, настраивать, эксплуатировать или обслуживать данное оборудование, прочитайте этот документ и документы, перечисленные в разделе «Дополнительные ресурсы». В этих документах изложены сведения об установке, настройке и эксплуатации данного оборудования. Пользователи обязаны ознакомиться с инструкциями по установке и прокладке соединений, а также с требованиями всех применимых норм, законов и стандартов.

Все действия, включая установку, наладку, ввод в эксплуатацию, использование, сборку, разборку и техническое обслуживание, должны выполняться обученным персоналом в соответствии с применимыми нормами и правилами.

Если оборудование используется не предусмотренным производителем образом, защита оборудования может быть нарушена.

注意：本製品を設置、構成、稼動または保守する前に、本書および本機器の設置、設定、操作についての参考資料の該当箇所に記載されている文書に目を通してください。ユーザは、すべての該当する条例、法律、規格の要件に加えて、設置および配線の手順に習熟している必要があります。

設置調整、運転の開始、使用、組立て、解体、保守を含む諸作業は、該当する実施規則に従って訓練を受けた適切な作業員が実行する必要があります。

本機器が製造メーカーにより指定されていない方法で使用されている場合、機器により提供されている保護が損なわれる恐れがあります。

ACHTUNG: Lesen Sie dieses Dokument und die im Abschnitt „Weitere Informationen“ aufgeführten Dokumente, die Informationen zu Installation, Konfiguration und Bedienung dieses Produkts enthalten, bevor Sie dieses Produkt installieren, konfigurieren, bedienen oder warten. Anwender müssen sich neben den Bestimmungen aller anwendbaren Vorschriften, Gesetze und Normen zusätzlich mit den Installations- und Verdrahtungsanweisungen vertraut machen.

Arbeiten im Rahmen der Installation, Anpassung, Inbetriebnahme, Verwendung, Montage, Demontage oder Instandhaltung dürfen nur durch ausreichend geschulte Mitarbeiter und in Übereinstimmung mit den anwendbaren Ausführungsvorschriften vorgenommen werden.

Wenn das Gerät in einer Weise verwendet wird, die vom Hersteller nicht vorgesehen ist, kann die Schutzfunktion beeinträchtigt sein.

ATTENTION : Lisez ce document et les documents listés dans la section Ressources complémentaires relatifs à l'installation, la configuration et le fonctionnement de cet équipement avant d'installer, configurer, utiliser ou entretenir ce produit. Les utilisateurs doivent se familiariser avec les instructions d'installation et de câblage en plus des exigences relatives aux codes, lois et normes en vigueur.

Les activités relatives à l'installation, le réglage, la mise en service, l'utilisation, l'assemblage, le démontage et l'entretien doivent être réalisées par des personnes formées selon le code de pratique en vigueur.

Si cet équipement est utilisé d'une façon qui n'a pas été définie par le fabricant, la protection fournie par l'équipement peut être compromise.

주의：본 제품 설치, 설정, 작동 또는 유지보수하기 전에 본 문서를 포함하여 설치, 설정 및 작동에 관한 참고 자료 섹션의 문서들을 반드시 읽고 숙지하십시오. 사용자는 모든 관련 규정, 법규 및 표준에서 요구하는 사항에 대해 반드시 설치 및 배선 지침을 숙지해야 합니다.

본 장비를 제조사가 명시하지 않은 방법으로 사용하면 장비의 보호 기능이 손상될 수 있습니다.

ATTENZIONE Prima di installare, configurare ed utilizzare il prodotto, o effettuare interventi di manutenzione su di esso, leggere il presente documento ed i documenti elencati nella sezione "Altre risorse", riguardanti l'installazione, la configurazione ed il funzionamento dell'apparecchiatura. Gli utenti devono leggere e comprendere le istruzioni di installazione e cablaggio, oltre ai requisiti previsti dalle leggi, codici e standard applicabili.

Le attività come installazione, regolazioni, utilizzo, assemblaggio, disassemblaggio e manutenzione devono essere svolte da personale adeguatamente addestrato, nel rispetto delle procedure previste.

Qualora l'apparecchio venga utilizzato con modalità diverse da quanto previsto dal produttore, la sua funzione di protezione potrebbe venire compromessa.

DIKKAT: Bu ürünün kurulumu, yapılındırılması, işletilmesi veya bakımı öncesinde bu dokümanı ve bu ekipmanın kurulumu, yapılındırılması ve işletimi ile ilgili ilave Kaynaklar bölümünde yer listelenmiş dokümanları okuyun. Kullanıcılar yürürlükteki tüm yönetmelikler, yasalar ve standartların gereksinimlerine ek olarak kurulum ve kablolama talimatlarını da öğrenmek zorundadır.

Kurulum, ayarlama, hizmete alma, kullanma, parçaları birleştirme, parçaları sökme ve bakım gibi aktiviteler sadece uygun eğitimleri almış kişiler tarafından yürürlükteki uygulama yönetmeliklerine uygun şekilde yapılabilir.

Bu ekipman üretici tarafından belirlenmiş amacın dışında kullanılırsa, ekipman tarafından sağlanan koruma bozulabilir.

注意事項：在安装、設定、操作或維護本產品前，請先閱讀此文件以及列於「其他資源」章節中有關安裝、設定與操作此設備的文件。使用者必須熟悉安裝和配線指示，並符合所有法規、法律和標準要求。

包括安裝、調整、交付使用、使用、組裝、拆卸和維護等動作都必須交由已經過適當訓練的人員進行，以符合適用的實作法規。

如果將設備用於非製造商指定的用途時，可能會造成設備所提供的保護功能受損。

POZOR: Než začnete instalovat, konfigurovat či provozovat tento výrobek nebo provádět jeho údržbu, přečtěte si tento dokument a dokumenty uvedené v části Dodatečné zdroje ohledně instalace, konfigurace a provozu tohoto zařízení. Uživatelé se musejí vedle požadavků všech relevantních vyhlášek, zákonů a norem nutně seznámit také s pokyny pro instalaci a elektrické zapojení.

Činnosti zahrnující instalaci, nastavení, uvedení do provozu, užívání, montáž, demontáž a údržbu musí vykonávat vhodně proškolený personál v souladu s příslušnými prováděcími předpisy.

Pokud se toto zařízení používá způsobem neodpovídajícím specifikaci výrobce, může být narušena ochrana, kterou toto zařízení poskytuje.

UWAGA: Przed instalacją, konfiguracją, użytkowaniem lub konserwacją tego produktu należy przeczytać niniejszy dokument oraz wszystkie dokumenty wymienione w sekcji Dodatkowe źródła omawiające instalację, konfigurację i procedury użytkowania tego urządzenia. Użytkownicy mają obowiązek zapoznać się z instrukcjami dotyczącymi instalacji oraz oprzewodowania, jak również z obowiązującymi kodeksami, prawem i normami.

Działania obejmujące instalację, regulację, przekazanie do użytkowania, użytkowanie, montaż, demontaż oraz konserwację muszą być wykonywane przez odpowiednio przeszkolony personel zgodnie z obowiązującym kodeksem postępowania.

Jeśli urządzenie jest użytkowane w sposób inny niż określony przez producenta, zabezpieczenie zapewniane przez urządzenie może zostać ograniczone.

Obs! Läs detta dokument samt dokumentet, som står listat i avsnittet Övriga resurser, om installation, konfiguration och drift av denna utrustning innan du installerar, konfigurerar eller börjar använda eller utföra underhållsarbete på produkten. Användare måste bekanta sig med instruktioner för installation och kabeldragning, förutom krav enligt gällande koder, lagar och standarder.

Åtgärder som installation, justering, service, användning, montering, demontering och underhållsarbete måste utföras av personal med lämplig utbildning enligt lämpligt bruk.

Om denna utrustning används på ett sätt som inte anges av tillverkaren kan det hända att utrustningens skyddsanordningar försätts ur funktion.

LET OP: Lees dit document en de documenten die genoemd worden in de paragraaf Aanvullende informatie over de installatie, configuratie en bediening van deze apparatuur voordat u dit product installeert, configureert, bedient of onderhoudt. Gebruikers moeten zich vertrouwd maken met de installatie en de bedringsinstructies, naast de vereisten van alle toepasselijke regels, wetten en normen.

Activiteiten zoals het installeren, afstellen, in gebruik stellen, gebruiken, monteren, demonteren en het uitvoeren van onderhoud mogen uitsluitend worden uitgevoerd door hiervoor opgeleid personeel en in overeenstemming met de geldende praktijkregels.

Indien de apparatuur wordt gebruikt op een wijze die niet is gespecificeerd door de fabrikant, dan bestaat het gevaar dat de beveiliging van de apparatuur niet goed werkt.

Environment and Enclosure

**ATTENTION:**

This equipment is intended for use in a Pollution Degree 2 industrial environment, in overvoltage Category II applications (as defined in EN/IEC 60664-1), at altitudes up to 2000 m (6562 ft) without derating.

This equipment is not intended for use in residential environments and may not provide adequate protection to radio communication services in such environments.

This equipment is supplied as open-type equipment for indoor use. It must be mounted within an enclosure that is suitably designed for those specific environmental conditions that will be present and appropriately designed to prevent personal injury resulting from accessibility to live parts. The enclosure must have suitable flame-retardant properties to prevent or minimize the spread of flame, complying with a flame spread rating of 5VA or be approved for the application if nonmetallic. The interior of the enclosure must be accessible only by the use of a tool. Subsequent sections of this publication may contain more information regarding specific enclosure type ratings that are required to comply with certain product safety certifications.

In addition to this publication, see the following:

- Industrial Automation Wiring and Grounding Guidelines, publication [1770-4.1](#), for additional installation requirements.
 - NEMA Standard 250 and IEC 60529, as applicable, for explanations of the degrees of protection provided by enclosures.
-



WARNING: If you insert or remove the module while backplane power is on, an electric arc can occur. This could cause an explosion in hazardous location installations. Be sure that power is removed or the area is nonhazardous before proceeding.



WARNING: If you connect or disconnect wiring while the field side power is on, an electric arc can occur. This could cause an explosion in hazardous location installations. Be sure that power is removed or the area is nonhazardous before proceeding.



ATTENTION: This product is grounded through the DIN rail to chassis ground. Use zinc-plated chromate-passivated steel DIN rail to assure proper grounding. The use of other DIN rail materials (for example, aluminum or plastic) that can corrode, oxidize, or are poor conductors, can result in improper or intermittent grounding. Secure DIN rail to mounting surface approximately every 200 mm (7.8 in.) and use end-anchors appropriately. Be sure to ground the DIN rail properly. See the Industrial Automation Wiring and Grounding Guidelines, Rockwell Automation publication [1770-4.1](#), for more information.

Prevent Electrostatic Discharge



ATTENTION: This equipment is sensitive to electrostatic discharge, which can cause internal damage and affect normal operation. Follow these guidelines when you handle this equipment:

- Touch a grounded object to discharge potential static.
 - Wear an approved grounding wriststrap.
 - Do not touch connectors or pins on component boards.
 - Do not touch circuit components inside the equipment.
 - Use a static-safe workstation, if available.
 - Store the equipment in appropriate static-safe packaging when not in use.
-



ATTENTION: Do not substitute a 1794-IF4I or 1794-IF4IXT with the 1794-IF4ICFXT, as this will force a remapping of IO and configuration data.



ATTENTION: Personnel responsible for the application of safety-related programmable electronic systems (PES) shall be aware of the safety requirements in the application of the system and shall be trained in using the system.



ATTENTION: Do not remove or replace a Terminal Base unit while power is applied. Interruption of the backplane can result in unintentional operation or machine motion.

UK and European Hazardous Location Approval

The following applies to products marked :

- Are Equipment Group II, Equipment Category 3, and comply with the Essential Health and Safety Requirements relating to the design and construction of such equipment given in Schedule 1 of UKEX and Annex II of EU Directive 2014/34/EU. See the UKEX and EU Declaration of Conformity at rok.auto/certifications for details.
- The type of protection is Ex ec IIC T4 Gc according to EN IEC 60079-0:2018, EXPLOSIVE ATMOSPHERES - PART 0: EQUIPMENT - GENERAL REQUIREMENTS, Issue Date 07/2018 and EN IEC 60079-7:2015+A1:2018, Explosive atmospheres. Equipment protection by increased safety "e".
- Comply with Standard EN IEC 60079-0:2018, EXPLOSIVE ATMOSPHERES - PART 0: EQUIPMENT - GENERAL REQUIREMENTS, Issue Date 07/2018, EN IEC 60079-7:2015+A1:2018 Explosive atmospheres. Equipment protection by increased safety "e", reference certificate number DEMKO 14 ATEX 1342501X and UL22UKEX2378X.
- Are intended for use in areas in which explosive atmospheres caused by gases, vapors, mists, or air are unlikely to occur, or are likely to occur only infrequently and for short periods. Such locations correspond to Zone 2 classification according to UKEX regulation 2016 No. 1107 and ATEX directive 2014/34/EU.

IEC Hazardous Location Approval

The following applies to products with IECEx certification:



- Are intended for use in areas in which explosive atmospheres caused by gases, vapors, mists, or air are unlikely to occur, or are likely to occur only infrequently and for short periods. Such locations correspond to Zone 2 classification to IEC 60079-0.
- The type of protection is Ex ec IIC T4 Gc according to IEC 60079-0 and IEC 60079-7.
- Comply with Standards IEC 60079-0, Explosive atmospheres Part 0: Equipment - General requirements, Edition 7, Revision Date 2017, IEC 60079-7, 5.1 Edition revision date 2017, Explosive atmospheres - Part 7: Equipment protection by increased safety "e", reference IECEx certificate number IECEx UL 14.0066X.



WARNING: Special Conditions for Safe Use

- This equipment is not resistant to sunlight or other sources of UV radiation.
- This equipment shall be mounted in an UKEX/ATEX/IECEx Zone 2 certified enclosure with a minimum ingress protection rating of at least IP54 (in accordance with EN/IEC 60079-0) and used in an environment of not more than Pollution Degree 2 (as defined in EN/IEC 60664-1) when applied in Zone 2 environments. The enclosure must be accessible only by the use of a tool.
- This equipment shall be used within its specified ratings defined by Rockwell Automation.
- Transient protection shall be provided that is set at a level not exceeding 140% of the peak rated voltage value at the supply terminals to the equipment.
- This equipment must be used only with UKEX/ATEX/IECEx certified Rockwell Automation backplanes.
- Secure any external connections that mate to this equipment by using screws, sliding latches, threaded connectors, or other means provided with this product.
- Do not disconnect equipment unless power has been removed or the area is known to be nonhazardous.
- Earthing is accomplished through mounting of modules on rail.

North American Hazardous Location Approval

The Following Information Applies When Operating This Equipment In Hazardous Locations.	Informations sur l'utilisation de cet équipement en environnements dangereux.
<p>Products marked "CL I, DIV 2, GP A, B, C, D" are suitable for use in Class I Division 2 Groups A, B, C, D, Hazardous Locations and nonhazardous locations only. Each product is supplied with markings on the rating nameplate indicating the hazardous location temperature code. When combining products within a system, the most adverse temperature code (lowest "T" number) may be used to help determine the overall temperature code of the system. Combinations of equipment in your system are subject to investigation by the local Authority Having Jurisdiction at the time of installation.</p>	<p>Les produits marqués "CL I, DIV 2, GP A, B, C, D" ne conviennent qu'à une utilisation en environnements de Classe I Division 2 Groupes A, B, C, D dangereux et non dangereux. Chaque produit est livré avec des marquages sur sa plaque d'identification qui indiquent le code de température pour les environnements dangereux. Lorsque plusieurs produits sont combinés dans un système, le code de température le plus défavorable (code de température le plus faible) peut être utilisé pour déterminer le code de température global du système. Les combinaisons d'équipements dans le système sont sujettes à inspection par les autorités locales qualifiées au moment de l'installation.</p>
<div style="display: flex; align-items: center;">  <div> <p>WARNING: Explosion Hazard –</p> <ul style="list-style-type: none"> • Do not disconnect equipment unless power has been removed or the area is known to be nonhazardous. • Do not disconnect connections to this equipment unless power has been removed or the area is known to be nonhazardous. Secure any external connections that mate to this equipment by using screws, sliding latches, threaded connectors, or other means provided with this product. • Substitution of components may impair suitability for Class I Division 2. </div> </div>	<div style="display: flex; align-items: center;">  <div> <p>AVERTISSEMENT: Risque d'Explosion –</p> <ul style="list-style-type: none"> • Couper le courant ou s'assurer que l'environnement est classé non dangereux avant de débrancher l'équipement. • Couper le courant ou s'assurer que l'environnement est classé non dangereux avant de débrancher les connecteurs. Fixer tous les connecteurs externes reliés à cet équipement à l'aide de vis, loquets coulissants, connecteurs filetés ou autres moyens fournis avec ce produit. • La substitution de composants peut rendre cet équipement inadapté à une utilisation en environnement de Classe I Division 2. </div> </div>

Overview

The FLEX I/O-XT™ isolated analog input module mounts on a 1794 terminal base. In addition to the features supported by the 1794-IF4I and 1794-IF4IXT modules, the 1794-IF4ICFXT features three additional parameters that allow additional control over the way the analog signals are processed by the module. The settings are at the module level.

Settings to these parameters affect all inputs set to 150 Hz, 300 Hz, or 600 Hz. The parameters do not affect channels set at 1200 Hz.

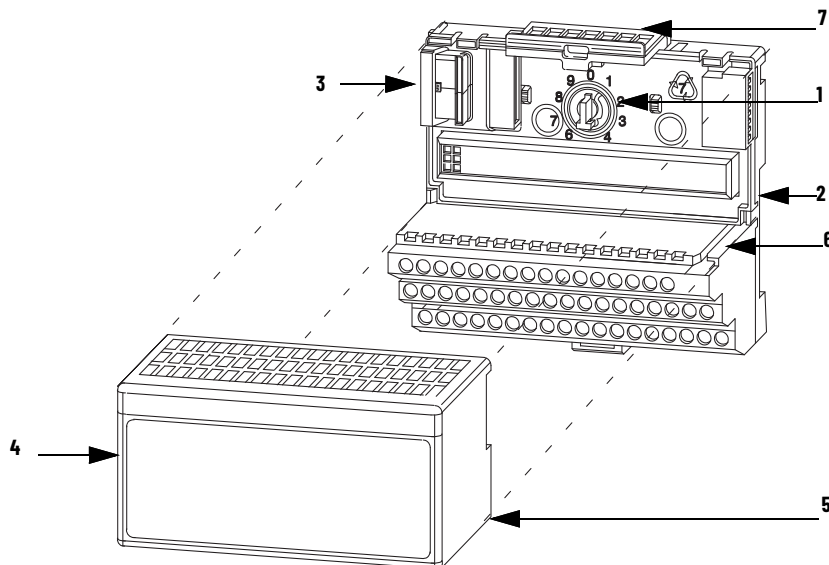

Component Description

	Description		Description
1	Keyswitch	5	Alignment bar
2	Terminal base	6	Groove
3	Flexbus connector	7	Latching mechanism
4	Module		

Install Your Module



ATTENTION: During mounting of all devices, be sure that all debris (metal chips, or wire strands, and so on) is kept from falling into the module. Debris that falls into the module could cause damage on power up. Keep a minimum of 25 mm (1 in.) of space on the top and bottom of the module, for adequate ventilation between equipment.

1. Rotate the keyswitch (1) on the terminal base (2) clockwise to position 3.
2. Verify that the Flexbus connector (3) is pushed all the way to the left to connect with the neighboring terminal base/adaptor. **You cannot install the module unless the connector is fully extended.**
3. Make sure the pins on the bottom of the module (4) are straight so that they align properly with the connector in the terminal base (2).
4. Position the module (4) with its alignment bar (5) aligned with the groove (6) on the terminal base (2).
5. Press firmly and evenly to seat the module (4) in the terminal base unit (2). The module (4) is seated when the latching mechanism (7) is locked into the module (4).

Wire Your Module

1. **For 1794-TB2, 1794-TB3, 1794-TB3S, 1794-TB3T, 1794-TB3TS** - Connect individual input/output wiring to numbered terminals on the 0...15 row (A) as indicated in [Table 1](#). Use Belden 8761 cable for signal wiring.
For 1794-TBN - Connect individual input/output wiring to even-numbered terminals on the 16...33 row (B) as indicated in [Table 1](#). Use Belden 8761 cable for signal wiring.



ATTENTION: Connect only one current or one voltage signal per channel. Do not connect both current and voltage on one channel.

2. **For 1794-TB2, 1794-TB3, 1794-TB3S, 1794-TB3T, 1794-TB3TS** - Connect each channel signal return to numbered terminals on 0...15 row (A) as indicated in [Table 1](#). Use Belden 8761 cable for signal wiring.
For 1794-TBN - Connect each channel signal return to odd-numbered terminals on row (C) as indicated in [Table 1](#).
3. Connect any signal wiring shields to functional ground as near as possible to the module.
For 1794-TB3T or 1794-TB3TS only: Connect cable shield to terminate C-39...C-46 (earth ground).
4. Connect the +V DC power to terminal 34 on the 34...51 row (C) and -V common/return to terminal 16 on the 16...33 row (B).



ATTENTION: To reduce susceptibility to noise, power analog modules and digital modules from separate power supplies.

5. If daisy chaining +V power to the next terminal base, connect a jumper from terminal 51 (+V DC) on this terminal base unit to terminal 34 on the next terminal base unit.
6. If continuing DC common (-V) to the next terminal base unit, connect a jumper from terminal 33 (common) on this terminal base unit to terminal 16 on the next terminal base unit.

Table 1 - Wiring Connections for 1794-IF4ICFXT Module

Channel	Signal Type	Label Markings	1794-TB2, 1794-TB3, 1794-TB3S, 1794-TB3T, 1794-TB3TS		1794-TBN
			Terminal	Shield (1794-TB3T, 1794-TB3TS)	Terminal
Input 0	Current	I0	A-0	C-39	B-0
	Current	I0 Ret	A-1		C-1
	Voltage	V0	A-2	C-40	B-2
	Voltage	V0 Ret	A-3		C-3
Input 1	Current	I1	A-4	C-41	B-4
	Current	I1 Ret	A-5		C-5
	Voltage	V1	A-6	C-42	B-6
	Voltage	V1 Ret	A-7		C-7
Output 0	Current	I2	A-8	C-43	B-8
	Current	I2 Ret	A-9		C-9
	Voltage	V2	A-10	C-44	B-10
	Voltage	V2 Ret	A-11		C-11
Output 1	Current	I3	A-12	C-45	B-12
	Current	I3 Ret	A-13		C-13
	Voltage	V3	A-14	C-46	B-14
	Voltage	V3 Ret	A-15		C-15
-V DC common	1794-TB2, 1794-TB3, 1794-TB3S - Terminals B-16...B-33 are internally connected in the terminal base unit. 1794-TBN - Terminals B-16 and B-33 are internally connected in the terminal base unit. 1794-TB3T, 1794-TB3TS - Terminals 16, 17, 19, 21, 23, 25, 27, 29, 31, and 33 are internally connected in the terminal base unit.				
+V DC power	1794-TB3, 1794-TB3S - Terminals 34...51 are internally connected in the terminal base unit. 1794-TB3T, 1794-TB3TS - Terminals 34, 35, 50, and 51 are internally connected in the terminal base unit. 1794-TBN, 1794-TB2 - Terminals 34 and 51 are internally connected in the terminal base unit.				
Chassis ground (shield)	1794-TB3T, 1794-TB3TS - Terminals 39...46 are internally connected to chassis ground.				

7. **1794-TB2, 1794-TB3, and 1794-TB3S** - Connect wiring shields to a functional earth ground as near as possible to the module.

Figure 1 - 1794-TB2, 1794-TB3, 1794-TB3S, 1794-TB3T, and 1794-TB3TS Terminal Base Wiring

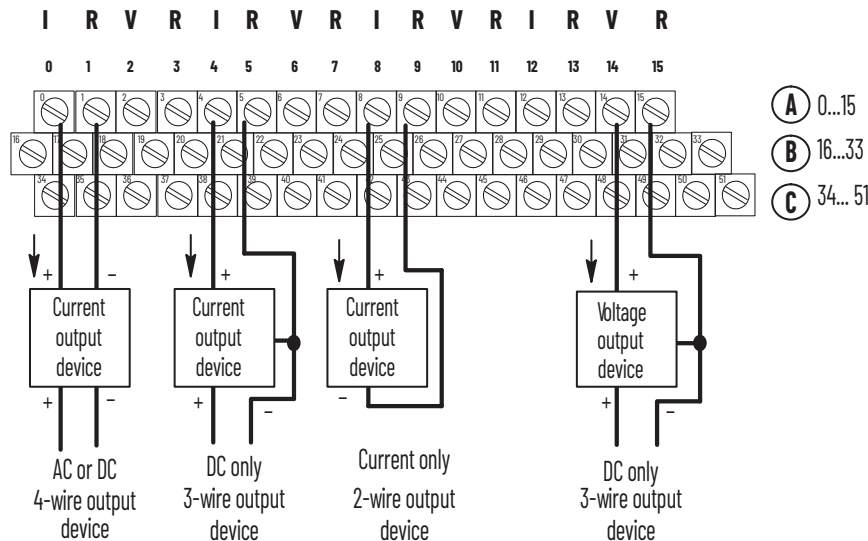
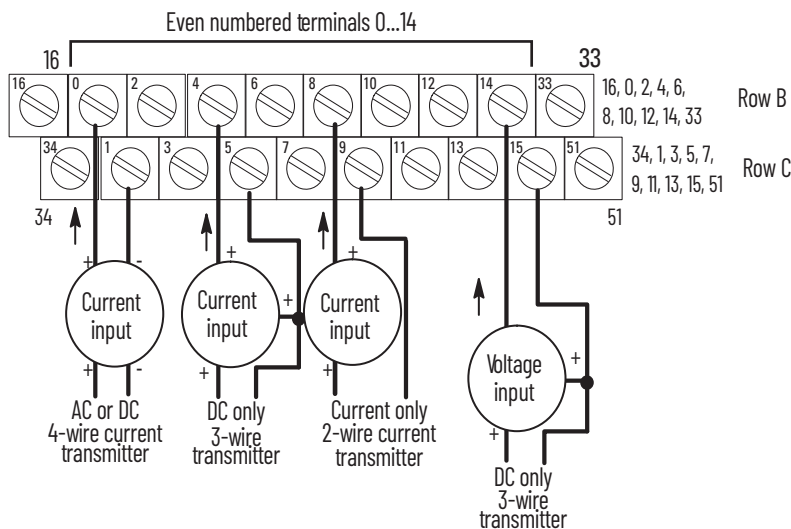

Figure 2 - 1794-TBN Terminal Base Wiring



Configure Your Module

Table 2 - Input Map

Dec.	15	14	13	12	11	10	9	8	7	6	5	4	3	2	1	0	
Oct.	17	16	15	14	13	12	11	10	7	6	5	4	3	2	1	0	
Word 0	Analog Value Channel 0																
Word 1	Analog Value Channel 1																
Word 2	Analog Value Channel 2																
Word 3	Analog Value Channel 3																
Word 4	Real time Sample																
Word 5	PU	FP	CF	0	Reserved				0	0	0	0	0	0	BD	DN	0
Word 6	0	0	0	0	0	0	0	0	V3	V2	V1	V0	U3	U2	U1	U0	
Where:	PU = Power-up unconfigured state FP = Field power off CF = In configuration mode BD = Bad calibration DN = Calibration accepted U = Underrange for specified channel V = Overrange for specified channel																

Table 3 - Output Map

Dec.	15	14	13	12	11	10	9	8	7	6	5	4	3	2	1	0
Oct.	17	16	15	14	13	12	11	10	7	6	5	4	3	2	1	0
Word 0	EN	0	0	0	0	0	0	0	0	0	0	0	0	0	0	0
Word 1	Channel 3 Filter				Channel 2 Filter				Channel 1 Filter				Channel 0 Filter			
Word 2	Ch 3 Configuration				Ch 2 Configuration				Ch 1 Configuration				Ch 0 Configuration			
Word 3	0	Real-time Sample Interval														
Word 4	IC	1	TR	IT	0	CH	SK	FS	RV	QK	CK	GO	Channel Number			
Word 5	Reserved															
Where:	EN = Enable bit (not used on input module) IC = Initiate configuration bit TR = Transparent bit IT = Interrupt toggle bit Ch - Chop mode disable – Use to disable the chop mode. Chop mode used by the module to reduce offset and drift errors. The default is chop mode enabled (0). SK = FIR filter disable – Use to disable the FIR filter. The Finite Impulse Response filter is used by the module to improve signal stability. The default is FIR filter enabled (0). FS = Fast step response – Use to enable a fast step response algorithm. The fast step response algorithm, upon sensing a step input, uses an averaging method rather than the FIR filter. The FIR returns into operation once the input has settled. The default is fast step response disabled (0). RV = Revert to default bit QK = Quick calibration CK = Calibration clock GO = Gain offset select															

Table 4 - Configure Your Input Channels

Input Channel Configuration							
03	02	01	00	Set these bits for channel 0.			
07	06	05	04	Set these bits for channel 1.			
11	10	09	08	Set these bits for channel 2.			
15	14	13	12	Set these bits for channel 3.			
Bit Settings				Input Values	Data Format	% Underrange % Overrange	Input Range
0	0	0	0	Channel not configured			
0	0	0	1	4...20 mA	Signed 2's complement	4% under; 4% over	<0000...7878>
0	0	1	0	±10V		2% under; 2% over	<831F...7CE1>
0	0	1	1	±5V		4% under; 4% over	<8618...79E8>
0	1	0	0	0...20 mA	Signed 2's complement %	0% under; 4% over	<0...2710>
0	1	0	1	4...20 mA		4% under; 4% over	<0...2710>
0	1	1	0	0...10V		0% under; 2% over	<0...2710>
0	1	1	1	±10V		2% under; 2% over	<08F0...2710>
1	0	0	0	0...20 mA	Binary	0% under; 4% over	<0000...F3CF>
1	0	0	1	4...20 mA		4% under; 4% over	<0000...FOF1>
1	0	1	0	0...10V		0% under; 2% over	<0000...F9C2>
1	0	1	1	0...5V		0% under; 4% over	<0000...F3CF>
1	1	0	0	0...20 mA	Offset binary, 8000H = 0 mA	4% under; 4% over	<0618...F9E8>
1	1	0	1	4...20 mA	Offset binary, 8000H = 4 mA	4% under; 4% over	<8000...F878>
1	1	1	0	±10V	Offset binary, 8000H = 0 mA	2% under; 2% over	<031F...FCE1>
1	1	1	1	±5V		4% under; 4% over	<0618...F9E8>

Table 5 - Input Update Rate for Real-Time Sample Interval = 0

Configuration Bits				Input Nominal Ranges	Channel Update Rate ⁽¹⁾ RTSI = 0 and No low Pass Filter	Channel Update Rate ⁽¹⁾ RTSI and Filter = 0 IT bit = 1
MSD	LSD					
0	0	0	1	4...20 mA	7.5 ms	5.0 ms
0	0	1	0	±10V	2.5 ms	2.5 ms
0	0	1	1	±5V	2.5 ms	2.5 ms
0	1	0	0	0...20 mA	7.5 ms	5.0 ms
0	1	0	1	4...20 mA	7.5 ms	5.0 ms
0	1	1	0	0...10V	5.0 ms	5.0 ms
0	1	1	1	±10V	5.0 ms	5.0 ms
1	0	0	0	0...20 mA	2.5 ms	2.5 ms
1	0	0	1	4...20 mA	7.5 ms	5.0 ms
1	0	1	0	0...10V	2.5 ms	2.5 ms
1	0	1	1	0...5V	2.5 ms	2.5 ms
1	1	0	0	0...20 mA	2.5 ms	2.5 ms
1	1	0	1	4...20 mA	7.5 ms	5.0 ms
1	1	1	0	±10V	2.5 ms	2.5 ms
1	1	1	1	±5V	2.5 ms	2.5 ms

(1) When IT = 1, the channel update rate for all channels is determined by the slowest channel.

Table 6 - Set the Input Filters

Input Channel Configuration					
03	02	01	00	Set these bits for channel 0.	
07	06	05	04	Set these bits for channel 1.	
11	10	09	08	Set these bits for channel 2.	
15	14	13	12	Set these bits for channel 3.	
Bit Settings				A/D Conversion Rate	Low Pass Filter
0	0	0	0	1200 Hz	No low pass
0	0	0	1	1200 Hz	100 ms low pass
0	0	1	0	1200 Hz	500 ms low pass

Table 6 - Set the Input Filters (Continued)

Input Channel Configuration					
0	0	1	1	1200 Hz	1000 ms low pass
0	1	0	0	600 Hz	No low pass
0	1	0	1	600 Hz	100 ms low pass
0	1	1	0	600 Hz	500 ms low pass
0	1	1	1	600 Hz	1000 ms low pass
1	0	0	0	300 Hz	No low pass
1	0	0	1	300 Hz	100 ms low pass
1	0	1	0	300 Hz	500 ms low pass
1	0	1	1	300 Hz	1000 ms low pass
1	1	0	0	150 Hz	No low pass
1	1	0	1	150 Hz	100 ms low pass
1	1	1	0	150 Hz	500 ms low pass
1	1	1	1	150 Hz	1000 ms low pass

Status Indicator

The OK status indicator is bi-colored red and green. The indicator flashes green for any of the following three reasons:

- The module configuration word is zero (for example, power-up reset condition).
- The 24V DC user power is off.
- The module is in configuration mode.

The indicator displays red to indicate that the module did not pass the initial hardware test. Cycle the power.

After power-up, if the status indicator is not flashing green or solid green, cycle the module power to verify a proper reset of the bus interface.

Specifications

General Specifications

Attribute	Value
Module location	1794-TB2, 1794-TB3, 1794-TB3S, 1794-TB3T, 1794-TB3TS, and 1794-TBN terminal base
Number of inputs	4 isolated
Resolution Voltage Current	16 bits - unipolar; 15 bits plus sign - bipolar 0.156 mV/cnt unipolar; 0.313 mV/cnt bipolar 0.320 μ A/cnt unipolar; 0.640 μ A/cnt bipolar
Update rate	2.5/5.0/7.5 ms all channels (see Table 5)
Input current terminal	4...20 mA (configurable) 0...20 mA (configurable) \pm 20 mA (configurable)
Input voltage terminal	\pm 10V (configurable) 0...10V (configurable) \pm 5V (configurable) 0...5V (configurable)
Input resistance Voltage terminal Current terminal	>10 M Ω <100 Ω ⁽¹⁾
Data format	2's complement 2's complement % Binary Offset binary
Conversion type	Sigma Delta
Update rate	2.5/5.0/7.5 ms all channels (see Table 5)
Normal mode rejection ratio - voltage or current terminal	-3 dB @ 12 Hz (300 Hz conversion rate) -80 dB @ 50 Hz (300 Hz conversion rate) -3 dB @ 6 Hz (150 Hz conversion rate) -80 dB @ 60 Hz (150 Hz conversion rate)
Common mode rejection ratio	-120 dB @ 50/60 Hz
Step response to 63% - voltage or current terminal	1200 Hz conversion rate = 0.6 ms 600 Hz conversion rate = 0.67 ms 300 Hz conversion rate = 13.4 ms 150 Hz conversion rate = 26.7 ms
Absolute accuracy ⁽²⁾ Voltage terminal Current terminal	0.1% Full Scale @ 25 °C (77 °F) 0.1% Full Scale @ 25 °C (77 °F)

General Specifications (Continued)

Attribute	Value
Accuracy drift with temperature Voltage terminal Current terminal	0.0028% Full Scale/°C 0.0038% Full Scale/°C
Calibration required	Factory-calibrated. Can be calibrated in the field when necessary
Maximum overload	30V continuous or 32 mA continuous, one channel at a time.
Indicators	1 red/green power/status indicator
Isolation voltage	120V (continuous), Basic Insulation Type, when used with 1794-TB2, 1794-TB3, 1794-TB3S, 1794-TB3T, or 1794-TB3TS 250V (continuous), Basic Insulation Type, when used with 1794-TBN Type tested at 1500V AC for 60 s and Routine tested at 2550V DC for 1 s, between channel to power, channel to system, and power to system, and channel to channel
Flexbus current	55 mA
Power dissipation, max	2.0 W @ 31.2V DC
Thermal dissipation, max	6.8 BTU/hr @ 31.2V DC
Keyswitch position	3
External DC power supply voltage Voltage range Supply current	24V DC nominal Supply: 19.2...31.2V DC, 145 mA Flexbus: 5V DC, 55 mA Input: 0...20 mA, ±10V DC
Dimensions (H x W x D)	46 x 94 x 75 mm (1.8 x 3.7 x 2.95 in.) with the module installed
Wire size	Determined by the installed terminal base
Wiring category ⁽³⁾	2 - on signal ports 2 - on power ports
Wire type	Shielded on signal ports
Enclosure type rating	None (open-style)
Terminal screw torque	Determined by the installed terminal base
North American temp code	T4
IECEX temp code	T4
UKEX/ATEX temp code	T4

(1) If 24V DC is removed from the module, input resistance = 10 kΩ

(2) Includes offset, gain, nonlinearity, and repeatability error terms.

(3) Use this conductor category information for planning conductor routing. See the Industrial Automation Wiring and Grounding Guidelines, publication [1770-4.1](#).

Environmental Specifications

Attribute	Value
Temperature, operating	IEC 60068-2-1 (Test Ad, Operating Cold), IEC 60068-2-2 (Test Bd, Operating Dry Heat), IEC 60068-2-14 (Test Nb, Operating Thermal Shock): -20...+70 °C (-4...+158 °F)
Temperature, surrounding air, max	70 °C (158 °F)
Temperature, nonoperating	IEC 60068-2-1 (Test Ab, Unpackaged nonoperating Cold), IEC 60068-2-2 (Test Bb, Unpackaged nonoperating Dry Heat), IEC 60068-2-14 (Test Na, Unpackaged nonoperating Thermal Shock): -40...+85 °C (-40...+185 °F)
Relative humidity	IEC 60068-2-30 (Test Db, Unpackaged Damp Heat): 5...95% noncondensing
Vibration	IEC 60068-2-6 (Test Fc, Operating): 5 g @ 10...500 Hz
Shock, operating	IEC 60068-2-27 (Test Ea, Unpackaged Shock): 30 g
Shock, nonoperating	IEC 60068-2-27 (Test Ea, Unpackaged Shock): 50 g
Emissions	IEC 61000-6-4
ESD immunity	IEC 61000-4-2: 6 kV contact discharges 8 kV air discharges
Radiated RF immunity	IEC 61000-4-3: 10V/m with 1 kHz sine-wave 80% AM from 80...6000 MHz
EFT/B immunity	IEC 61000-4-4: ±2 kV at 5 kHz on power ports ±2 kV at 5 kHz on signal ports
Surge transient immunity	IEC 61000-4-5: ±1 kV line-line(DM) and ±2 kV line-earth(CM) on power ports ±2 kV line-earth(CM) on shielded signal ports
Conducted RF immunity	IEC 61000-4-6: 10V rms with 1 kHz sine-wave 80% AM from 150 kHz...80 MHz

Certifications

Attribute (when product is marked) ⁽¹⁾	Value
c-UL-us	UL Listed Industrial Control Equipment, certified for US and Canada. See UL File E65584. UL Listed for Class I Division 2 Group A,B,C,D Hazardous Locations, certified for U.S. and Canada. See UL File E194810.
UK and CE	UK Statutory Instrument 2016 No. 1091 and European Union 2014/30/EU EMC Directive, compliant with: EN 61326-1; Meas./Control/Lab., Industrial Requirements EN 61000-6-2; Industrial Immunity EN 61131-2; Programmable Controllers EN 61000-6-4; Industrial Emissions UK Statutory Instrument 2012 No. 3032 and European Union 2011/65/EU RoHS, compliant with: EN 63000; Technical documentation
RCM	Australian Radiocommunications Act, compliant with: EN 61000-6-4; Industrial Emissions
Ex	UK Statutory Instrument 2016 No. 1107 and European Union 2014/34/EU ATEX Directive, compliant with: EN IEC 60079-0; General Requirements EN IEC 60079-7; Explosive Atmospheres, Protection "e" II 3 G Ex ec IIC T4 Gc DEMKO 14 ATEX 1342501X UL22UKE2378X
IECEX	IECEX System, compliant with: IEC 60079-0; General Requirements IEC 60079-7; Explosive Atmospheres, Protection "e" Ex ec IIC T4 Gc IECEX UL 14.0066X
TÜV	TÜV Certified for Functional Safety: Capable of SIL 2
KC	Korean Registration of Broadcasting and Communications Equipment, compliant with: Article 58-2 of Radio Waves Act, Clause 3
Morocco	Arrêté ministériel n° 6404-15 du 29 ramadan 1436
CCC	CNCA-C23-01 强制性产品认证实施规则 防爆电气 CNCA-C23-01 CCC Implementation Rule Explosion-Proof Electrical Products

(1) See the Product Certification link at rok.auto/certifications for Declarations of Conformity, Certificates, and other certification details.

Additional Resources

For more information on the products that are described in this publication, use these resources. You can view or download publications at rok.auto/literature.

Resource	Description
FLEX I/O and FLEX I/O-XT Selection Guide, publication 1794-S6002	Provides information on how to select FLEX™ I/O and FLEX I/O-XT adapters, terminal bases, I/O modules, and accessories.
FLEX I/O Isolated Analog Modules User Manual, publication 1794-UM008	A detailed description of module functionality, configuration, and information on how to use FLEX I/O isolated analog modules.
Industrial Automation Wiring and Grounding Guidelines, publication 1770-4.1	More information on proper wiring and grounding techniques.
Product Certifications website, rok.auto/certifications	Provides declarations of conformity, certificates, and other certification details.

Rockwell Automation Support

Use these resources to access support information.

Technical Support Center	Find help with how-to videos, FAQs, chat, user forums, Knowledgebase, and product notification updates.	rok.auto/support
Local Technical Support Phone Numbers	Locate the telephone number for your country.	rok.auto/phonesupport
Technical Documentation Center	Quickly access and download technical specifications, installation instructions, and user manuals.	rok.auto/techdocs
Literature Library	Find installation instructions, manuals, brochures, and technical data publications.	rok.auto/literature
Product Compatibility and Download Center (PCDC)	Download firmware, associated files (such as AOP, EDS, and DTM), and access product release notes.	rok.auto/pcdc

Documentation Feedback

Your comments help us serve your documentation needs better. If you have any suggestions on how to improve our content, complete the form at rok.auto/docfeedback.





Waste Electrical and Electronic Equipment (WEEE)



At the end of life, this equipment should be collected separately from any unsorted municipal waste.

Rockwell Automation maintains current product environmental compliance information on its website at rok.auto/pec.

Rockwell Otomasyon Ticaret A.Ş. Kar Plaza İş Merkezi E Blok Kat:6 34752 İçerenköy, İstanbul, Tel: +90 (216) 5698400 EEE Yönetmeliğine Uygundur

Connect with us.    

rockwellautomation.com — expanding **human possibility**[®]

AMERICAS: Rockwell Automation, 1201 South Second Street, Milwaukee, WI 53204-2496 USA, Tel: (1) 414.382.2000

EUROPE/MIDDLE EAST/AFRICA: Rockwell Automation NV, Pegasus Park, De Kleetlaan 12a, 1831 Diegem, Belgium, Tel: (32) 2663 0600

ASIA PACIFIC: Rockwell Automation SEA Pte Ltd, 2 Corporation Road, #04-05, Main Lobby, Corporation Place, Singapore 618494, Tel: (65) 6510 6608

UNITED KINGDOM: Rockwell Automation Ltd., Pitfield, Kiln Farm, Milton Keynes, MK11 3DR, United Kingdom, Tel: (44)(1908) 838-800

Allen-Bradley, expanding human possibility, FactoryTalk, FLEX, FLEX I/O-XT, Rockwell Automation, and TechConnect are trademarks of Rockwell Automation, Inc. Trademarks not belonging to Rockwell Automation are property of their respective companies.

Publication 1794-IN130D-EN-P - April 2024 | Supersedes Publication 1794-IN130C-EN-P - October 2022
Copyright © 2024 Rockwell Automation, Inc. All rights reserved.