

# Installation Instructions

Original Instructions



**Allen-Bradley**

by ROCKWELL AUTOMATION

## Stratix 2500 Lightly Managed Switches

Catalog Numbers 1783-LMS5, 1783-LMS8

Topic	Page
Parts List	4
Required Tools/Components	4
Enclosure Requirements	5
Site Requirements	5
Mount the Switch	5
Ground the Switch	6
Wire the DC Power Source	6
Install the Power Connector on the Switch	8
Connect to 10/100 Ports	8
Confirm Installation	9
Remove the Switch from a DIN Rail	9
Specifications	9
Additional Resources	9

### Summary of Changes

This publication contains the following new or updated information. This list includes substantive updates only and is not intended to reflect all changes.

Topic	Page
Special Conditions of Use	3
UK and European Hazardous Location Approval	3



**ATTENTION:** Read this document and the documents listed in the Additional Resources section about installation, configuration and operation of this equipment before you install, configure, operate or maintain this product. Users are required to familiarize themselves with installation and wiring instructions in addition to requirements of all applicable codes, laws, and standards.

Activities including installation, adjustments, putting into service, use, assembly, disassembly, and maintenance are required to be carried out by suitably trained personnel in accordance with applicable code of practice. If this equipment is used in a manner not specified by the manufacturer, the protection provided by the equipment may be impaired.

注意：在安装、配置、操作和维护本产品前，请阅读本文档以及“其他资源”部分列出的有关设备安装、配置和操作的相应文档。除了所有适用规范、法律和标准的相关要求之外，用户还必须熟悉安装和接线说明。

安装、调整、投运、使用、组装、拆卸和维护等各项操作必须由经过适当训练的专业人员按照适用的操作规范实施。

如果未按照制造商指定的方式使用该设备，则可能会损害设备提供的保护。

**ATENCIÓN:** Antes de instalar, configurar, poner en funcionamiento o realizar el mantenimiento de este producto, lea este documento y los documentos listados en la sección Recursos adicionales acerca de la instalación, configuración y operación de este equipo. Los usuarios deben familiarizarse con las instrucciones de instalación y cableado y con los requisitos de todos los códigos, leyes y estándares vigentes.

El personal debidamente capacitado debe realizar las actividades relacionadas a la instalación, ajustes, puesta en servicio, uso, ensamblaje, desensamblaje y mantenimiento de conformidad con el código de práctica aplicable. Si este equipo se usa de una manera no especificada por el fabricante, la protección provista por el equipo puede resultar afectada.

**ATENÇÃO:** Leia este e os demais documentos sobre instalação, configuração e operação do equipamento que estão na seção Recursos adicionais antes de instalar, configurar, operar ou manter este produto. Os usuários devem se familiarizar com as instruções de instalação e fiação além das especificações para todos os códigos, leis e normas aplicáveis.

É necessário que as atividades, incluindo instalação, ajustes, colocação em serviço, utilização, montagem, desmontagem e manutenção sejam realizadas por pessoal qualificado e especializado, de acordo com o código de prática aplicável.

Caso este equipamento seja utilizado de maneira não estabelecida pelo fabricante, a proteção fornecida pelo equipamento pode ficar prejudicada.

**ВНИМАНИЕ:** Перед тем как устанавливать, настраивать, эксплуатировать или обслуживать данное оборудование, прочитайте этот документ и документы, перечисленные в разделе «Дополнительные ресурсы». В этих документах изложены сведения об установке, настройке и эксплуатации данного оборудования. Пользователи обязаны ознакомиться с инструкциями по установке и прокладке соединений, а также с требованиями всех применимых норм, законов и стандартов.

Все действия, включая установку, наладку, ввод в эксплуатацию, использование, сборку, разборку и техническое обслуживание, должны выполняться обученным персоналом в соответствии с применимыми нормами и правилами.

Если оборудование используется не предусмотренным производителем образом, защита оборудования может быть нарушена.

注意：本製品を設置、構成、稼働または保守する前に、本書および本機器の設置、設定、操作についての参考資料の該当箇所に記載されている文書に目を通してください。ユーザは、すべての該当する条例、法律、規格の要件に加えて、設置および配線の手順に習熟している必要があります。

設置調整、運転の開始、使用、組立て、解体、保守を含む諸作業は、該当する実施規則に従って訓練を受けた適切な作業員が実行する必要があります。本機器が製造メーカーにより指定されていない方法で使用されている場合、機器により提供されている保護が損なわれる恐れがあります。

**ACHTUNG:** Lesen Sie dieses Dokument und die im Abschnitt „Weitere Informationen“ aufgeführten Dokumente, die Informationen zu Installation, Konfiguration und Bedienung dieses Produkts enthalten, bevor Sie dieses Produkt installieren, konfigurieren, bedienen oder warten. Anwender müssen sich neben den Bestimmungen aller anwendbaren Vorschriften, Gesetze und Normen zusätzlich mit den Installations- und Verdrahtungsanweisungen vertraut machen.

Arbeiten im Rahmen der Installation, Anpassung, Inbetriebnahme, Verwendung, Montage, Demontage oder Instandhaltung dürfen nur durch ausreichend geschulte Mitarbeiter und in Übereinstimmung mit den anwendbaren Ausführungsvorschriften vorgenommen werden.

Wenn das Gerät in einer Weise verwendet wird, die vom Hersteller nicht vorgesehen ist, kann die Schutzfunktion beeinträchtigt sein.

**ATTENTION:** Lisez ce document et les documents listés dans la section Ressources complémentaires relatifs à l'installation, la configuration et le fonctionnement de cet équipement avant d'installer, configurer, utiliser ou entretenir ce produit. Les utilisateurs doivent se familiariser avec les instructions d'installation et de câblage en plus des exigences relatives aux codes, lois et normes en vigueur.

Les activités relatives à l'installation, le réglage, la mise en service, l'utilisation, l'assemblage, le démontage et l'entretien doivent être réalisées par des personnes formées selon le code de pratique en vigueur.

Si cet équipement est utilisé d'une façon qui n'a pas été définie par le fabricant, la protection fournie par l'équipement peut être compromise.

주의：본 제품 설치, 설정, 작동 또는 유지 보수하기 전에 본 문서를 포함하여 설치, 설정 및 작동에 관한 참고 자료 섹션의 문서들을 반드시 읽고 숙지하십시오. 사용자는 모든 관련 규정, 법규 및 표준에서 요구하는 사항에 대해 반드시 설치 및 배선 지침을 숙지해야 합니다.

설치, 조정, 가동, 사용, 조립, 분해, 유지보수 등 모든 작업은 관련 규정에 따라 적절한 교육을 받은 사용자들 통해서만 수행해야 합니다.

본 장비를 제조사가 명시하지 않은 방법으로 사용하면 장비의 보호 기능이 손상될 수 있습니다.

**ATTENZIONE:** Prima di installare, configurare ed utilizzare il prodotto, o effettuare interventi di manutenzione di manutenzione su di esso, leggere il presente documento ed i documenti elencati nella sezione "Altre risorse", riguardanti l'installazione, la configurazione ed il funzionamento dell'apparecchiatura. Gli utenti devono leggere e comprendere le istruzioni di installazione e cablaggio, oltre ai requisiti previsti dalle leggi, codici e standard applicabili.

Le attività come installazione, regolazioni, utilizzo, assemblaggio, disassemblaggio e manutenzione devono essere svolte da personale adeguatamente addestrato, nel rispetto delle procedure previste.

Qualora l'apparecchio venga utilizzato con modalità diverse da quanto previsto dal produttore, la sua funzione di protezione potrebbe venire compromessa.

**DİKKAT:** Bu ürünün kurulumu, yapılandırılması, işletilmesi veya bakımı öncesinde bu dokümanı ve bu ekipmanın kurulumu, yapılandırılması ve işletimi ile ilgili ilave Kaynaklar bölümünde yer listelenmiş dokümanları okuyun. Kullanıcılar yürürlükteki tüm yönetmelikler, yasalar ve standartların gereksinimlerine ek olarak kurulum ve kablolarla talimatlarını da öğrenmek zorundadır. Kurulum, ayarlama, hizmete alma, kullanma, parçaları birleştirme, parçaları sökme ve bakım gibi aktiviteler sadece uygun eğitimleri almış kişiler tarafından yürürlükteki uygulamaya yönetmeliklerine uygun şekilde yapılabilir.

Bu ekipman üretici tarafından belirlenmiş amacın dışında kullanılırsa, ekipman tarafından sağlanan koruma bozulabilir.

注意事項：在安装、設定、操作或維護本產品前，請先閱讀此文件以及列於「其他資源」章節中有關安裝、設定與操作此設備的文件。使用者必須熟悉安裝和配線指示，並符合所有法規、法律和標準要求。

包括安裝、調整、交付使用、使用、組裝、拆卸和維護等動作都必須交由已經適當訓練的人員進行，以符合適用的實作法規。

如果將設備用於非製造商指定的用途時，可能會造成設備所提供的保護功能受損。

**POZOR:** Než začnete instalovat, konfigurovat či provozovat tento výrobek nebo provádět jeho údržbu, přečtěte si tento dokument a dokumenty uvedené v části Dodatečné zdroje ohledně instalace, konfigurace a provozu tohoto zařízení. Uživatelé se musejí vedle požadavků všech relevantních vyhlásek, zákonů a norem nutně seznámit také s pokyny pro instalaci a elektrické zapojení.

Činnosti zahrnující instalaci, nastavení, uvedení do provozu, užívání, montáž, demontáž a údržbu musí vykonávat vhodně proškolený personál v souladu s příslušnými prováděcími předpisy. Pokud se toto zařízení používá způsobem neodpovídajícím specifikaci výrobce, může být narušena ochrana, kterou toto zařízení poskytuje.

**UWAGA:** Przed instalacją, konfiguracją, użytkowaniem lub konserwacją tego produktu należy przeczytać niniejszy dokument oraz wszystkie dokumenty wymienione w sekcji Dodatkowe źródła omawiające instalację, konfigurację i procedury użytkowania tego urządzenia. Użytkownicy mają obowiązek zapoznać się z instrukcjami dotyczącymi instalacji oraz oprowadowania, jak również z obowiązującymi kodeksami, prawem i normami.

Działania obejmujące instalację, regulację, przekazanie do użytkowania, użytkowanie, montaż, demontaż oraz konserwację muszą być wykonywane przez odpowiednio przeszkolony personel zgodnie z obowiązującym kodeksem postępowania.

Jeśli urządzenie jest użytkowane w sposób inny niż określony przez producenta, zabezpieczenie zapewniane przez urządzenie może zostać ograniczone.

**OBS!** Läs detta dokument samt dokumentet, som står listat i avsnittet Övriga resurser, om installation, konfigurering och drift av denna utrustning innan du installerar, konfigurerar eller börjar använda eller utföra underhållsarbete på produkten. Användare måste bekanta sig med instruktioner för installation och kabeldragning, förutom krav enligt gällande koder, lagar och standarder.

Åtgärder som installation, justering, service, användning, montering, demontering och underhållsarbete måste utföras av personal med lämplig utbildning enligt lämpligt bruk.

Om denna utrustning används på ett sätt som inte anges av tillverkaren kan det hända att utrustningens skyddsanordningar försätts ur funktion.

**LET OP:** Lees dit document en de documenten die genoemd worden in de paragraaf Aanvullende informatie over de installatie, configuratie en bediening van deze apparatuur voordat u dit product installeert, configureert, bedient of onderhoudt. Gebruikers moeten zich vertrouwd maken met de installatie en de bedradinginstructies, naast de vereisten van alle toepasselijke regels, wetten en normen.

Activiteiten zoals het installeren, afstellen, in gebruik stellen, gebruiken, monteren, demonteren en het uitvoeren van onderhoud mogen uitsluitend worden uitgevoerd door hiervoor opgeleid personeel en in overeenstemming met de geldende praktijkregels.

Indien de apparatuur wordt gebruikt op een wijze die niet is gespecificeerd door de fabrikant, dan bestaat het gevaar dat de beveiliging van de apparatuur niet goed werkt.



**ATTENTION: Environment and Enclosure**

This equipment is intended for use in a Pollution Degree 2 industrial environment, in overvoltage Category II applications (as defined in EN/IEC 60664-1), at altitudes up to 2000 m (6562 ft) without derating.

This equipment is not intended for use in residential environments and may not provide adequate protection to radio communication services in such environments.

This equipment is supplied as open-type equipment for indoor use. It must be mounted within an enclosure that is suitably designed for those specific environmental conditions that will be present and appropriately designed to prevent personal injury resulting from accessibility to live parts. The enclosure must have suitable flame-retardant properties to prevent or minimize the spread of flame, complying with a flame spread rating of 5VA or be approved for the application if nonmetallic. The interior of the enclosure must be accessible only by the use of a tool. Subsequent sections of this publication may contain more information regarding specific enclosure type ratings that are required to comply with certain product safety certifications.

In addition to this publication, see the following:

- Industrial Automation Wiring and Grounding Guidelines, publication [1770-4.1](#), for more installation requirements.
- NEMA Standard 250 and EN/IEC 60529, as applicable, for explanations of the degrees of protection provided by enclosures.



**WARNING: Special Conditions of Use**

- This equipment is not resistant to sunlight or other sources of UV radiation.
- This equipment shall be mounted in an ATEX Zone 2 certified enclosure with a minimum ingress protection rating of at least IP54 (in accordance with EN IEC 60079-0) and used in an environment of not more than Pollution Degree 2 (as defined in EN IEC 60664-1) when applied in Zone 2 environments. The enclosure must be accessible only by the use of a tool.
- This equipment shall be used within its specified ratings defined by Rockwell Automation.
- Transient protection shall be provided that is set at a level not exceeding 140% of the peak rated voltage at the supply terminals to the equipment.
- The instructions in the user manual shall be observed.
- Secure any external connections that mate to this equipment by using screws, sliding latches, threaded connectors, or other means provided with this product.
- Do not disconnect equipment unless power has been removed or the area is known to be nonhazardous.

**UK and European Hazardous Location Approval**

**The following applies to products marked II 3 G. Such modules:**

- Are Equipment Group II, Equipment Category 3, and comply with the Essential Health and Safety Requirements relating to the design and construction of such equipment given in Annex II of EU Directive 2014/34/EU and Schedule 1 of the UKEX Regulation 2016 No. 1107. See UKEX and EU Declaration of Conformity at [rok.auto/certifications](http://rok.auto/certifications) for details.
- The type of protection is <Ex ec IIC T4 Gc> Equipment protection by increased safety "e".
- Equipment protection by increased safety "e", reference certificate number DEMK0 16 ATEX 1731X and UL23UKEX2946X.
- Are intended for use in areas in which explosive atmospheres caused by gases, vapors, mists, or air are unlikely to occur, or are likely to occur only infrequently and for short periods. Such locations correspond to Zone 2 classification according to UKEX Regulation 2016 No. 1107 and ATEX directive 2014/34/EU.

**North American Hazardous Location Approval**

**The following information applies when operating this equipment in hazardous locations:**

Products marked "CL I, DIV 2, GP A, B, C, D" are suitable for use in Class I Division 2 Groups A, B, C, D, Hazardous Locations and nonhazardous locations only. Products marked "Class I, Zone 2, Protection Type AEx nA IIC T4 / Class I, Zone 2, Protection Type Ex nA IIC T4 Gc" are suitable for use in Class I, Zone 2 classifications. Each product is supplied with markings on the rating nameplate indicating the hazardous location temperature code. When combining products within a system, the most adverse temperature code (lowest "T" number) may be used to help determine the overall temperature code of the system. Combinations of equipment in your system are subject to investigation by the local Authority Having Jurisdiction at the time of installation.

**Informations sur l'utilisation de cet équipement en environnements dangereux:**

Les produits marqués "CL I, DIV 2, GP A, B, C, D" conviennent uniquement à une utilisation dans les emplacements dangereux et non dangereux de classe I division 2 groupes A, B, C, D. Les produits marqués "Classe I, Zone 2, Protection Type AEx nA IIC T4 / Classe I, Zone 2, Protection Type Ex nA IIC T4 Gc" conviennent à une utilisation dans des classifications de Classe I, Zone 2. Chaque produit est fourni avec des marquages sur sa plaque signalétique indiquant le code de température pour environnement dangereux. Si vous combinez des produits au sein d'un même système, utilisez le code de température le plus défavorable (chiffre "T" le plus bas) pour déterminer le code de température global du système. Les combinaisons d'équipements dans le système sont sujettes à inspection par les autorités locales qualifiées au moment de l'installation.



**WARNING: Explosion Hazard**

- Do not disconnect equipment unless power has been removed or the area is known to be nonhazardous.
- Do not disconnect connections to this equipment unless power has been removed or the area is known to be nonhazardous. Secure any external connections that mate to this equipment by using screws, sliding latches, threaded connectors, or other means provided with this product.
- Substitution of components may impair suitability for Class I, Division 2.
- If this product contains batteries, they must only be changed in an area known to be nonhazardous.



**AVERTISSEMENT: Risque d'Explosion**

- Couper le courant ou s'assurer que l'environnement est classé non dangereux avant de débrancher l'équipement.
- Couper le courant ou s'assurer que l'environnement est classé non dangereux avant de débrancher les connecteurs. Fixer tous les connecteurs externes reliés à cet équipement à l'aide de vis, loquets coulissants, connecteurs filetés ou autres moyens fournis avec ce produit.
- La substitution de composants peut rendre cet équipement inadapté à une utilisation en environnement de Classe I, Division 2.
- S'assurer que l'environnement est classé non dangereux avant de changer les piles.

- UL 60079-0, Sixth Edition
- UL 60079-15, Third Edition
- CSA-C22.2 No. 60079-0:15, October 2015.
- CSA-C22.2 No. 60079-15:12, January 2012.



**WARNING:** Use supply wires suitable for 30 °C (86 °F) above surrounding ambient.

---



**WARNING:** When used in a Class I, Division 2, hazardous location, this equipment must be mounted in a suitable enclosure with proper wiring method that complies with the governing electrical codes.

---



**WARNING:** If you connect or disconnect wiring while the field-side power is on, an electric arc can occur. This could cause an explosion in hazardous location installations. Be sure that power is removed or the area is nonhazardous before proceeding.

---



**WARNING:** When you press the Express Setup button while power is on, an electric arc can occur. This could cause an explosion in hazardous location installations. Be sure that power is removed or the area is nonhazardous before proceeding.

---

## Parts List

Verify that you have these items.

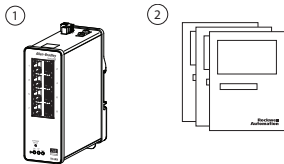

- 1 Stratix® 2500 switch
- 2 Documentation



At the end of its life, this equipment should be collected separately from any unsorted municipal waste.

---

## Required Tools/Components

Obtain these necessary tools and equipment:

- Ratcheting torque flathead screwdriver that exerts up to 2.03 N•m (17.96 in•lb) of pressure.
- For the protective ground connector, obtain a single or pair of stu size 6 ring terminals, such as Hollingsworth part number R3456B or equivalent.
- Crimping tool, such as Thomas & Bett part number WT4000, ERG-2001, or equivalent.
- 10-gauge copper ground wire.
- For DC power connections, use UL- and CSA-rated, style 1007 or 1569 twisted-pair copper appliance wiring material (AWM) wire.
- Wire-stripping tools for stripping 10- and 18-gauge wires.
- A number-2 Phillips screwdriver.
- A flat-blade screwdriver.

## Enclosure Requirements

Observe these enclosure requirements:

- Clearance to front and rear panels must meet these conditions:
  - Front-panel status indicators are clearly visible.
  - Access to ports is sufficient for unrestricted cabling.
  - Top-panel DC power connector is within reach of the connection to the DC power source.
- Airflow around the switch must be unrestricted. To prevent the switch from overheating, you must have the following minimum clearances:
  - Top and bottom: 50.8 mm (2.0 in.)
  - Sides: 25.4 mm (1.0 in.)
  - Front: 50.8 mm (2.0 in.)
- Temperatures inside the enclosure must conform to device specifications, as described in the Stratix Ethernet Device Specifications Technical Data, publication [1783-TD001](#).

---

**IMPORTANT** When the switch is installed in an industrial enclosure, the temperature within the enclosure is greater than normal room temperature outside the enclosure.

---

## Site Requirements

When determining where to place the switch, observe these guidelines:

- Cabling is away from sources of electrical noise, such as radios, power lines, and fluorescent lighting fixtures.
- For 10/100 ports, the cable length from a switch to an attached device cannot exceed 100 meters (328 ft).

## Mount the Switch

The switch ships with a spring-loaded latch on the rear panel that you can use to mount the switch on a DIN rail.

To mount the switch to a DIN rail, follow these steps.

1. Position the rear panel of the switch directly in front of the DIN rail, making sure that the DIN rail fits in the space between the two hooks near the top of the switch and the spring-loaded latch near the bottom.
2. Holding the bottom of the switch away from the DIN rail, place the two hooks on the back of the switch over the top of the DIN rail.

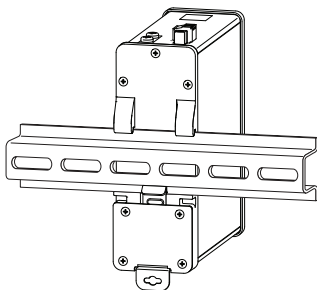

3. Push the switch toward the DIN rail to cause the spring-loaded latch at the bottom rear of the switch to move down, and snap into place.

## Ground the Switch

The ground lug is not supplied with the switch. You can use one of these options:

- Single ring terminal
- Two single ring terminals

To ground the switch to earth ground by using the ground screw, follow these steps:

1. Use a standard Phillips screwdriver or a ratcheting torque screwdriver with a Phillips head to remove the ground screw from the top panel of the switch. Store the ground screw for later use.
2. Use the manufacturer's guidelines to determine the wire length to be stripped.
3. Insert the ground wire into the ring terminal lug, and use a crimping tool to crimp the terminal to the wire. If you are using two ring terminals, repeat this action for the second ring terminal.

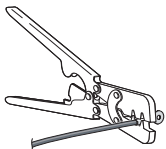

4. Slide the ground screw from step 1 through the ring terminal.
5. Insert the ground screw into the functional ground screw opening on the top panel.
6. Use a ratcheting torque screwdriver to tighten the ground screws and ring terminal lugs to the switch top panel. The torque must not exceed 0.51 N•m (4.5 in•lb).

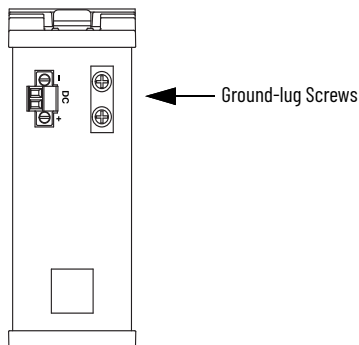

7. Attach the other end of the ground wire to a grounded bare metal surface, such as a ground bus, a grounded DIN rail, or a grounded bare rack.

## Wire the DC Power Source

To wire the switch to a DC power source, follow these steps.

1. Locate the power connector on the top of the switch labeled DC.
2. Identify the positive and return DC power connections.

Label	Connection
+	Positive DC power connection.
-	Return DC power connection.

3. Measure two strands of twisted-pair copper wire (16-to-18 AWG) long enough to connect to the DC power source.
4. Use an 18-gauge wire-stripping tool to strip each of the two twisted-pair wires coming from each DC-input power source to 6.3 mm (0.25in.) ± 0.5 mm (0.02 in.). Do not strip more than 6.8 mm (0.27 in.) of insulation from the wire. Stripping more than the recommended amount of wire can leave exposed wire from the power connector after installation.

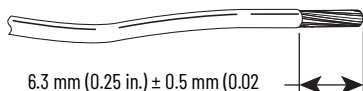

- Remove the two captive screws that attach the power connector to the switch, and remove the power connector.

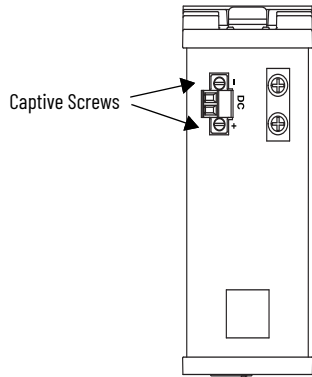

- On the power connector, insert the exposed part of the positive wire into the connection labeled + and the exposed part of the return wire into the connection labeled -. Make sure that you cannot see any wire lead. Only wire with insulation should extend from the connector.

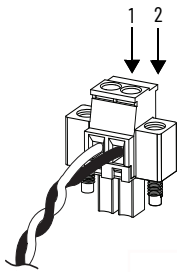

1	Power source positive connection
2	Power source return connection

- Use a ratcheting torque flathead screwdriver to torque the power connector captive screws above the installed wire leads to 0.19 N•m (1.7 in•lb).

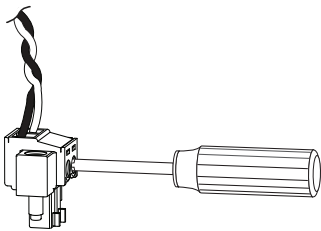

- Connect the other end of the positive wire to the positive terminal on the DC power source, and connect the other end of the return wire to the return terminal on the DC power source.

## Install the Power Connector on the Switch

To attach the power connector to the top panel of the switch, follow these steps.

1. Insert the power connector into the DC receptacle on the top of the switch.
2. Use a ratcheting torque flathead screwdriver to tighten the captive screws on the sides of the power connector to 0.19 N•m (1.7 in•lb). The torque must not exceed 0.19 N•m (1.7 in•lb).

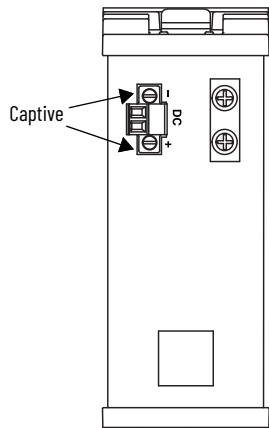

---

**IMPORTANT** Make sure wires coming from the power connector cannot be disturbed by casual contact. For example, use tie wraps to secure the wires to the rack.

---

## Connect to 10/100 Ports

The switch 10/100 ports automatically configure themselves to operate at the speed of attached devices. If the attached ports do not support autonegotiation, you can explicitly set the speed and duplex parameters. Connecting devices that do not autonegotiate or that have their speed and duplex parameters manually set can reduce performance or result in no linkage.

To maximize performance, choose one of these methods for configuring the Ethernet ports:

- Let the ports autonegotiate both speed and duplex.
- Set the port speed and duplex parameters on both ends of the connection.

To connect to 10BASE-T or 100BASE-T devices, follow these steps for each device.

1. When connecting to workstations, servers, and routers, connect a straight-through cable to an RJ45 connector on the front panel.
2. Connect the other end of the cable to an RJ45 connector on the other device.

The port status indicator turns on when both the switch and the connected device have established a link. The port status indicator is amber while Spanning Tree Protocol (STP) discovers the topology and searches for loops. This can last as long as 30 seconds, and then the port status indicator turns green.

If the port status indicator does not turn on, check the following possible causes:

- The device at the other end is not be turned on.
  - There is a cable problem or a problem with the adapter installed in the attached device.
3. If necessary, reconfigure and restart the connected device.

## Confirm Installation

Before you install the switch in its final location, power on the switch, and verify that the switch powers up within 30 seconds.

## Remove the Switch from a DIN Rail

To remove the switch from a DIN rail, follow these steps.

1. Remove power from the switch, and disconnect all cables and connectors from the switch.
2. Insert a tool, such as a flathead screwdriver, in the slot at the bottom of the spring-loaded latch and use it to release the latch from the DIN rail.
3. Pull the bottom of the switch away from the DIN rail, and lift the hooks off the top of the DIN rail.

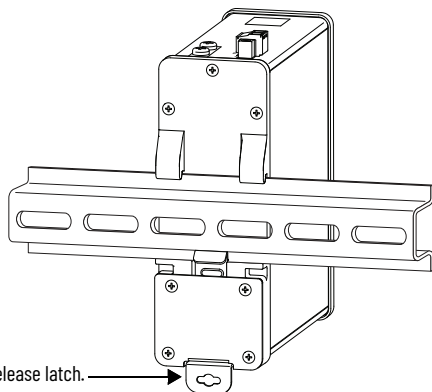

4. Remove the switch from the DIN rail.

## Specifications

Attribute	1783-LMS5	1783-LMS8
Temperature, operating IEC 60068-2-1 (Test Ad, Operating Cold), IEC 60068-2-2 (Test Bd, Operating Dry Heat), IEC 60068-2-14 (Test Nb, Operating Thermal Shock)	-20 ≤ Ta ≤ +60 °C (-4 ≤ Ta ≤ +140 °F)	
Temperature, ambient, max	60 °C (140 °F)	
Temperature, surrounding air, max	60 °C (140 °F)	
Enclosure type rating	None (open-style)	
Power input	12...24V DC, 0.3...0.2A (SELV)	12...24V DC, 0.4...0.2A (SELV)
Wire size, Ethernet connections	RJ45 connector according to IEC 60603-7, 2 or 4 pair Category 5e minimum cable according to TIA 568-B.1 or Category 5 cable according to ISO/IEC 24702	
Wire size, functional ground	5.2...3.3 mm <sup>2</sup> (10...12 AWG) solid or stranded copper wire	
Wire size, DC power	1.30...0.82 mm <sup>2</sup> (16...18 AWG) solid or stranded copper wire rated at 30 °C (86 °F), or greater, above the surrounding air temperature	
Torque, power terminal screw	0.19 N•m (1.7 in•lb)	
Torque, functional ground lug screw	0.51 N•m (4.5 in•lb)	
Temp code	T4	

## Additional Resources

These documents contain additional information concerning related products from Rockwell Automation.

Resource	Description
Stratix Ethernet Device Specifications Technical Data, publication <a href="#">1783-TD002</a>	Provides specification information for Ethernet switches and other devices.
Stratix 2500 Lightly Managed Switches User Manual, publication <a href="#">1783-UM009</a>	Describes how to configure, monitor, and troubleshoot the switch.
Industrial Automation Wiring and Grounding Guidelines, publication <a href="#">1770-4.1</a>	Provides general guidelines for installing a Rockwell Automation industrial system.
Product Certifications website, <a href="#">rok.auto/certifications</a>	Provides declarations of conformity, certificates, and other certification details.

You can view or download publications at <http://www.rockwellautomation.com/global/literature-library/overview.page>. To order paper copies of technical documentation, contact your local Allen-Bradley distributor or Rockwell Automation sales representative.

# Rockwell Automation Support

Use these resources to access support information.

<b>Technical Support Center</b>	Find help with how-to videos, FAQs, chat, user forums, Knowledgebase, and product notification updates.	<a href="http://rok.auto/support">rok.auto/support</a>
<b>Local Technical Support Phone Numbers</b>	Locate the telephone number for your country.	<a href="http://rok.auto/phonesupport">rok.auto/phonesupport</a>
<b>Technical Documentation Center</b>	Quickly access and download technical specifications, installation instructions, and user manuals.	<a href="http://rok.auto/techdocs">rok.auto/techdocs</a>
<b>Literature Library</b>	Find installation instructions, manuals, brochures, and technical data publications.	<a href="http://rok.auto/literature">rok.auto/literature</a>
<b>Product Compatibility and Download Center (PCDC)</b>	Download firmware, associated files (such as AOP, EDS, and DTM), and access product release notes.	<a href="http://rok.auto/pcdc">rok.auto/pcdc</a>

## Documentation Feedback

Your comments help us serve your documentation needs better. If you have any suggestions on how to improve our content, complete the form at [rok.auto/docfeedback](http://rok.auto/docfeedback).





## Waste Electrical and Electronic Equipment (WEEE)



At the end of life, this equipment should be collected separately from any unsorted municipal waste.

Rockwell Automation maintains current product environmental compliance information on its website at [rok.auto/pec](http://rok.auto/pec).

Rockwell Otomasyon Ticaret A.Ş. Kar Plaza İş Merkezi E Blok Kat:6 34752 İçerenköy, İstanbul, Tel: +90 (216) 5698400 EEE Yönetmeliğine Uygundur

Connect with us.    

**rockwellautomation.com** — expanding **human possibility**<sup>®</sup>

AMERICAS: Rockwell Automation, 1201 South Second Street, Milwaukee, WI 53204-2496 USA, Tel: (1) 414.382.2000, Fax: (1) 414.382.4444

EUROPE/MIDDLE EAST/AFRICA: Rockwell Automation NV, Pegasus Park, De Kleetlaan 12a, 1831 Diegem, Belgium, Tel: (32) 2 663 0600, Fax: (32) 2 663 0640

ASIA PACIFIC: Rockwell Automation, Level 14, Core F, Cyberport 3, 100 Cyberport Road, Hong Kong, Tel: (852) 2887 4788, Fax: (852) 2508 1846

UNITED KINGDOM: Rockwell Automation Ltd. Pitfield, Kiln Farm Milton Keynes, MK11 3DR, United Kingdom, Tel: (44)(1908) 838-800, Fax: (44)(1908) 261-917

Allen-Bradley, expanding human possibility, Rockwell Automation, Rockwell Software, and Stratix are trademarks of Rockwell Automation, Inc. Trademarks not belonging to Rockwell Automation are property of their respective companies.