



ControlLogix 16-point Sinking Safety Input Module

Catalog Number 1756-IB16S

Topic	Page
Summary of Changes	1
Product Advisories	3
Before You Begin	5
About the Module	5
Install the Module	6
Key the Removable Terminal Block (RTB)	6
Connect Wiring	6
Assemble the RTB and the Housing	7
Install the RTB	7
Specifications	7
Additional Resources	8

The 1756-IB16S module is a 16-point sinking safety input module. Use the safety module in a ControlLogix® chassis to provide safety I/O on a safety-control network that meets the requirements up to and including SIL 3, and PLe, cat. 4 as defined in IEC 61508, IEC 61511, IEC 62061, and ISO 13849-1.

Summary of Changes

This publication contains new and updated information as indicated in the following table.

Topic	Page
Updated UK and European Hazardous Location Approval	3
Updated IEC Hazardous Location Approval	3
Updated Special Conditions for Safe Use	3



ATTENTION: Read this document and the documents listed in the Additional Resources section about installation, configuration and operation of this equipment before you install, configure, operate or maintain this product. Users are required to familiarize themselves with installation and wiring instructions in addition to requirements of all applicable codes, laws, and standards.

Activities including installation, adjustments, putting into service, use, assembly, disassembly, and maintenance are required to be carried out by suitably trained personnel in accordance with applicable code of practice. If this equipment is used in a manner not specified by the manufacturer, the protection provided by the equipment may be impaired.

注意：在安装、配置、操作和维护本产品前，请阅读本文档以及“其他资源”部分列出的有关设备安装、配置和操作的相应文档。除了所有适用规范、法律和标准的相关要求之外，用户还必须熟悉安装和接线说明。

安装、调整、投运、使用、组装、拆卸和维护等各项操作必须由经过适当训练的专业人员按照适用的操作规范实施。

如果未按照制造商指定的方式使用该设备，则可能会损害设备提供的保护。

ATENCIÓN: Antes de instalar, configurar, poner en funcionamiento o realizar el mantenimiento de este producto, lea este documento y los documentos listados en la sección Recursos adicionales acerca de la instalación, configuración y operación de este equipo. Los usuarios deben familiarizarse con las instrucciones de instalación y cableado y con los requisitos de todos los códigos, leyes y estándares vigentes.

El personal debidamente capacitado debe realizar las actividades relacionadas a la instalación, ajustes, puesta en servicio, uso, ensamblaje, desensamblaje y mantenimiento de conformidad con el código de práctica aplicable. Si este equipo se usa de una manera no especificada por el fabricante, la protección provista por el equipo puede resultar afectada.

ATENÇÃO: Leia este e os demais documentos sobre instalação, configuração e operação do equipamento que estão na seção Recursos adicionais antes de instalar, configurar, operar ou manter este produto. Os usuários devem se familiarizar com as instruções de instalação e fiação além das especificações para todos os códigos, leis e normas aplicáveis.

É necessário que as atividades, incluindo instalação, ajustes, colocação em serviço, utilização, montagem, desmontagem e manutenção sejam realizadas por pessoal qualificado e especializado, de acordo com o código de prática aplicável.

Caso este equipamento seja utilizado de maneira não estabelecida pelo fabricante, a proteção fornecida pelo equipamento pode ficar prejudicada.

ВНИМАНИЕ: Перед тем как устанавливать, настраивать, эксплуатировать или обслуживать данное оборудование, прочитайте этот документ и документы, перечисленные в разделе «Дополнительные ресурсы». В этих документах изложены сведения об установке, настройке и эксплуатации данного оборудования. Пользователи обязаны ознакомиться с инструкциями по установке и прокладке соединений, а также с требованиями всех применимых норм, законов и стандартов.

Все действия, включая установку, наладку, ввод в эксплуатацию, использование, сборку, разборку и техническое обслуживание, должны выполняться обученным персоналом в соответствии с применимыми нормами и правилами.

Если оборудование используется не предусмотренным производителем образом, защита оборудования может быть нарушена.

注意：本製品を設置、構成、稼働または保守する前に、本書および本機器の設置、設定、操作についての参考資料の該当箇所に記載されている文書を目を通してください。ユーザは、すべての該当する条例、法律、規格の要件に加えて、設置および配線の手順に習熟している必要があります。

設置調整、運転の開始、使用、組立て、解体、保守を含む諸作業は、該当する実施規則に従って訓練を受けた適切な作業員が実行する必要があります。

本機器が製造メーカーにより指定されていない方法で使用されている場合、機器により提供されている保護が損なわれる恐れがあります。

ACHTUNG: Lesen Sie dieses Dokument und die im Abschnitt „Weitere Informationen“ aufgeführten Dokumente, die Informationen zu Installation, Konfiguration und Bedienung dieses Produkts enthalten, bevor Sie dieses Produkt installieren, konfigurieren, bedienen oder warten. Anwender müssen sich neben den Bestimmungen aller anwendbaren Vorschriften, Gesetze und Normen zusätzlich mit den Installations- und Verdrahtungsanweisungen vertraut machen.

Arbeiten im Rahmen der Installation, Anpassung, Inbetriebnahme, Verwendung, Montage, Demontage oder Instandhaltung dürfen nur durch ausreichend geschulte Mitarbeiter und in Übereinstimmung mit den anwendbaren Ausführungsvorschriften vorgenommen werden.

Wenn das Gerät in einer Weise verwendet wird, die vom Hersteller nicht vorgesehen ist, kann die Schutzfunktion beeinträchtigt sein.

ATTENTION: Lisez ce document et les documents listés dans la section Ressources complémentaires relatifs à l'installation, la configuration et le fonctionnement de cet équipement avant d'installer, configurer, utiliser ou entretenir ce produit. Les utilisateurs doivent se familiariser avec les instructions d'installation et de câblage en plus des exigences relatives aux codes, lois et normes en vigueur.

Les activités relatives à l'installation, le réglage, la mise en service, l'utilisation, l'assemblage, le démontage et l'entretien doivent être réalisées par des personnes formées selon le code de pratique en vigueur.

Si cet équipement est utilisé d'une façon qui n'a pas été définie par le fabricant, la protection fournie par l'équipement peut être compromise.

주의：본 제품 설치, 설정, 작동 또는 유지 보수하기 전에 본 문서를 포함하여 설치, 설정 및 작동에 관한 참고 자료 섹션의 문서들을 반드시 읽고 숙지하십시오. 사용자는 모든 관련 규정, 법규 및 표준에서 요구하는 사항에 대해 반드시 설치 및 배선 지침을 숙지해야 합니다.

설치, 조정, 가동, 사용, 조립, 분해, 유지보수 등 모든 작업은 관련 규정에 따라 적절한 교육을 받은 사용자를 통해서만 수행해야 합니다.

본 장비를 제조사가 명시하지 않은 방법으로 사용하면 장비의 보호 기능이 손상될 수 있습니다.

ATTENZIONE: Prima di installare, configurare ed utilizzare il prodotto, o effettuare interventi di manutenzione su di esso, leggere il presente documento ed i documenti elencati nella sezione "Altre risorse", riguardanti l'installazione, la configurazione ed il funzionamento dell'apparecchiatura. Gli utenti devono leggere e comprendere le istruzioni di installazione e cablaggio, oltre ai requisiti previsti dalle leggi, codici e standard applicabili.

Le attività come installazione, regolazioni, utilizzo, assemblaggio, disassemblaggio e manutenzione devono essere svolte da personale adeguatamente addestrato, nel rispetto delle procedure previste.

Qualora l'apparecchio venga utilizzato con modalità diverse da quanto previsto dal produttore, la sua funzione di protezione potrebbe venire compromessa.

DİKKAT: Bu ürünün kurulumu, yapılandırılması, işletilmesi veya bakımı öncesinde bu dokümanı ve bu ekipmanın kurulumu, yapılandırılması ve işletimi ile ilgili ilave Kaynaklar bölümünde yer listelenmiş dokümanları okuyun. Kullanıcılar yürürlükteki tüm yönetmelikler, yasalar ve standartların gereksinimlerine ek olarak kurulum ve kablolarla talimatlarını da öğrenmek zorundadır. Kurulum, ayarlama, hizmete alma, kullanma, parçaları birleştirme, parçaları sökme ve bakım gibi aktiviteler sadece uygun eğitimleri almış kişiler tarafından yürürlükteki uygulamaya yönetmeliklerine uygun şekilde yapılabilir.

Bu ekipman üretici tarafından belirlenmiş amacın dışında kullanılırsa, ekipman tarafından sağlanan koruma bozulabilir.

注意事項：在安装、設定、操作或維護本產品前，請先閱讀此文件以及列於「其他資源」章節中有關安裝、設定與操作此設備的文件。使用者必須熟悉安裝和配線指示，並符合所有法規、法律和標準要求。

包括安裝、調整、交付使用、使用、組裝、拆卸和維護等動作都必須交由已經過適當訓練的人員進行，以符合適用的實作法規。

如果將設備用於非製造商指定的用途時，可能會造成設備所提供的保護功能受損。

POZOR: Než začnete instalovat, konfigurovat či provozovat tento výrobek nebo provádět jeho údržbu, přečtěte si tento dokument a dokumenty uvedené v části Dodatečné zdroje ohledně instalace, konfigurace a provozu tohoto zařízení. Uživatelé se musejí vedle požadavků všech relevantních vyhlášek, zákonů a norem nutně seznámit také s pokyny pro instalaci a elektrické zapojení.

Činnosti zahrnující instalaci, nastavení, uvedení do provozu, užívání, montáž, demontáž a údržbu musí vykonávat vhodně proškolený personál v souladu s příslušnými prováděcími předpisy. Pokud se toto zařízení používá způsobem neodpovídajícím specifikaci výrobce, může být narušena ochrana, kterou toto zařízení poskytuje.

UWAGA: Przed instalacją, konfiguracją, użytkowaniem lub konserwacją tego produktu należy przeczytać niniejszy dokument oraz wszystkie dokumenty wymienione w sekcji Dodatkowe źródła omawiające instalację, konfigurację i procedury użytkowania tego urządzenia. Użytkownicy mają obowiązek zapoznać się z instrukcjami dotyczącymi instalacji oraz oprzewodowania, jak również z obowiązującymi kodeksami, prawem i normami.

Działania obejmujące instalację, regulację, przekazanie do użytkowania, użytkowanie, montaż, demontaż oraz konserwację muszą być wykonywane przez odpowiednio przeszkolony personel zgodnie z obowiązującym kodeksem postępowania.

Jeśli urządzenie jest użytkowane w sposób inny niż określony przez producenta, zabezpieczenie zapewniane przez urządzenie może zostać ograniczone.

OBST! Läs detta dokument samt dokumentet, som står listat i avsnittet Övriga resurser, om installation, konfigurering och drift av denna utrustning innan du installerar, konfigurerar eller börjar använda eller utföra underhållsarbete på produkten. Användare måste bekanta sig med instruktioner för installation och kabeldragning, förutom krav enligt gällande koder, lagar och standarder.

Åtgärder som installation, justering, service, användning, montering, demontering och underhållsarbete måste utföras av personal med lämplig utbildning enligt lämpligt bruk.

Om denna utrustning används på ett sätt som inte anges av tillverkaren kan det hända att utrustningens skyddsanordningar försätts ur funktion.



LET OP: Lees dit document en de documenten die genoemd worden in de paragraaf Aanvullende informatie over de installatie, configuratie en bediening van deze apparatuur voordat u dit product installeert, configureert, bedient of onderhoudt. Gebruikers moeten zich vertrouwd maken met de installatie en de bedringsinstructies, naast de vereisten van alle toepasselijke regels, wetten en normen.

Activiteiten zoals het installeren, afstellen, in gebruik stellen, gebruiken, monteren, demonteren en het uitvoeren van onderhoud mogen uitsluitend worden uitgevoerd door hiervoor opgeleide personeel en in overeenstemming met de geldende praktijkregels.

Indien de apparatuur wordt gebruikt op een wijze die niet is gespecificeerd door de fabrikant, dan bestaat het gevaar dat de beveiliging van de apparatuur niet goed werkt.

Product Advisories

North American Hazardous Location Approval

The following information applies when operating this equipment in hazardous locations.	Informations sur l'utilisation de cet équipement en environnements dangereux.
<p>Products marked "CL I, DIV 2, GP A, B, C, D" are suitable for use in Class I Division 2 Groups A, B, C, D, Hazardous Locations and nonhazardous locations only. Each product is supplied with markings on the rating nameplate indicating the hazardous location temperature code. When combining products within a system, the most adverse temperature code (lowest "T" number) may be used to help determine the overall temperature code of the system. Combinations of equipment in your system are subject to investigation by the local Authority Having Jurisdiction at the time of installation.</p>	<p>Les produits marqués "CL I, DIV 2, GP A, B, C, D" ne conviennent qu'à une utilisation en environnements de Classe I Division 2 Groupes A, B, C, D dangereux et non dangereux. Chaque produit est livré avec des marquages sur sa plaque d'identification qui indiquent le code de température pour les environnements dangereux. Lorsque plusieurs produits sont combinés dans un système, le code de température le plus défavorable (code de température le plus faible) peut être utilisé pour déterminer le code de température global du système. Les combinaisons d'équipements dans le système sont sujettes à inspection par les autorités locales qualifiées au moment de l'installation.</p>
 <p>WARNING: Explosion Hazard -</p> <ul style="list-style-type: none"> Do not disconnect equipment unless power has been removed or the area is known to be nonhazardous. Do not disconnect connections to this equipment unless power has been removed or the area is known to be nonhazardous. Secure any external connections that mate to this equipment by using screws, sliding latches, threaded connectors, or other means provided with this product. Substitution of components may impair suitability for Class I, Division 2. If this product contains batteries, they must only be changed in an area known to be nonhazardous. 	 <p>AVERTISSEMENT: Risque d'Explosion -</p> <ul style="list-style-type: none"> Couper le courant ou s'assurer que l'environnement est classé non dangereux avant de débrancher l'équipement. Couper le courant ou s'assurer que l'environnement est classé non dangereux avant de débrancher les connecteurs. Fixer tous les connecteurs externes reliés à cet équipement à l'aide de vis, loquets coulissants, connecteurs filetés ou autres moyens fournis avec ce produit. La substitution de composants peut rendre cet équipement inadapté à une utilisation en environnement de Classe I, Division 2. S'assurer que l'environnement est classé non dangereux avant de changer les piles.

UK and European Hazardous Location Approval

The following applies to products marked  , II 3 G. Such modules:

- Are Equipment Group II, Equipment Category 3, and comply with the Essential Health and Safety Requirements relating to the design and construction of such equipment given in Annex II to EU Directive 2014/34/EU and Schedule 1 of the UKEX Regulation 2016 No. 1107. See the UKEX and EU Declaration of Conformity at rok.auto/certifications for details.
- The type of protection is <Ex ec IIC T4 Gc> Equipment protection by increased safety "e".
- Equipment protection by increased safety "e", reference certificate number DEMK019ATEX2189X and UL220UKEX2603X.
- Are intended for use in areas in which explosive atmospheres caused by gases, vapors, mists, or air are unlikely to occur, or are likely to occur only infrequently and for short periods. Such locations correspond to Zone 2 classification according to UKEX Regulation 2016 No. 1107 and ATEX directive 2014/34/EU.

IEC Hazardous Location Approval

The following applies to products with IECEx certification. Such products:

- Are intended for use in areas in which explosive atmospheres caused by gases, vapors, mists, or air are unlikely to occur, or are likely to occur only infrequently and for short periods. Such locations correspond to Zone 2 classification.
- The type of protection is <Ex ec IIC T4 Gc>.
- IECEx certificate number IECEx UL 19.0021X.

Special Conditions for Safe Use



WARNING:

- This equipment is not resistant to sunlight or other sources of UV radiation.
- This equipment shall be mounted in an UKEX/ATEX/IECEx Zone 2 certified enclosure with a minimum ingress protection rating of at least IP54 (in accordance with EN/IEC 60079-0) and used in an environment of not more than Pollution Degree 2 (as defined in EN/IEC 60664-1) when applied in Zone 2 environments. The enclosure must be accessible only by the use of a tool.
- This equipment shall be used within its specified ratings defined by Rockwell Automation.
- Transient protection shall be provided that is set at a level not exceeding 140% of the peak rated voltage at the supply terminals to the equipment.
- The instructions in the user manual shall be observed.
- This equipment must be used only with UKEX/ATEX/IECEx certified Rockwell Automation backplanes.
- Secure any external connections that mate to this equipment by using screws, sliding latches, threaded connectors, or other means provided with this product.
- Do not disconnect equipment unless power has been removed or the area is known to be nonhazardous.
- The USB port is intended for temporary local programming purposes only and not intended for permanent connection. Do not use the USB port in hazardous locations.



ATTENTION: Personnel responsible for the application of safety-related programmable electronic systems (PES) shall be aware of the safety requirements in the application of the system and shall be trained in using the system. This equipment is certified for use only within the surrounding air temperature range of 0...60 °C (32...140 °F). The equipment must not be used outside of this range.

In case of malfunction or damage, make no attempt at repair. Return the module to the manufacturer for repair. Do not dismantle the module. Use only a soft dry anti-static cloth to wipe down equipment. Do not use any cleaning agents.

IMPORTANT Any illustrations, charts, sample programs, and layout examples that are shown in this publication are intended solely for the purposes of example. Since there are many variables and requirements that are associated with any particular installation, Rockwell Automation does not assume responsibility or liability for actual use based on the examples that are shown in this publication.

Environment and Enclosure



ATTENTION: This equipment is intended for use in a Pollution Degree 2 industrial environment, in overvoltage Category II applications (as defined in EN/IEC 60664-1), at altitudes up to 2000 m (6562 ft) without derating. This equipment is considered Group 1, Class A industrial equipment according to IEC/CISPR 11. Without appropriate precautions, there may be difficulties with electromagnetic compatibility in residential and other environments due to conducted and radiated disturbances.

This equipment is supplied as open-type equipment. It must be mounted within an enclosure that is suitably designed for those specific environmental conditions that will be present and appropriately designed to help prevent personal injury resulting from accessibility to live parts. The enclosure must have suitable flame-retardant properties to help prevent or minimize the spread of flame, complying with a flame spread rating of 5VA, V2, V1, V0 (or equivalent) if non-metallic. The interior of the enclosure must be accessible only by the use of a tool. Subsequent sections of this publication may contain additional information regarding specific enclosure type ratings that are required to comply with certain product safety certifications.

In addition to this publication, see the following:

- Industrial Automation Wiring and Grounding Guidelines, publication [1770-4.1](#), for additional installation requirements.
- NEMA Standard 250 and EN/IEC 60529, as applicable, for explanations of the degrees of protection provided by different types of enclosure.

Prevent Electrostatic Discharge



ATTENTION: This equipment is sensitive to electrostatic discharge, which can cause internal damage and affect normal operation. Follow these guidelines when you handle this equipment:

- Touch a grounded object to discharge potential static.
- Wear an approved grounding wriststrap.
- Do not touch connectors or pins on component boards.
- Do not touch circuit components inside the equipment.
- Use a static-safe workstation, if available.
- Store the equipment in appropriate static-safe packaging when not in use.



ATTENTION: Power to this equipment and all connected I/O must be supplied from a source compliant with the following:

- Safety extra low voltage (SELV) source approved to EN/IEC 60950-1, EN/IEC 61010-2-201 or EN/IEC 62368-1 (ES1)
- Protected extra low voltage (PELV) PELV source approved to EN/IEC 60950-1, EN/IEC 61010-2-201 or EN/IEC 62368-1 (ES1)

For UL-compliant applications, the 1756-IB16S module and all connected I/O must be powered from a SELV or PELV-compliant power source that is rated 150VA maximum. All other I/O modules in the same chassis must use an SELV/PELV power supply.

Wire conductor and insulation ratings shall support a minimum temperature rating of 105 °C (221 °F).

When using the 1756-TBCHS, do not wire more than two 0.33...1.3 mm² (22...16 AWG) conductors on any terminal.

Use only the same size wires with no intermixing of solid and stranded wire types.

When using the 1756-TBS6HS, do not wire multiple 0.33...2.1 mm² (22...14 AWG) conductors on any terminal.

Removal and Insertion Under Power (RIUP)



WARNING: When you insert or remove the module while backplane power is on, an electric arc can occur. This could cause an explosion in hazardous location installations. Be sure that power is removed or the area is nonhazardous before proceeding. Repeated electric arcing causes excessive wear to contacts on both the module and its mating connector. Worn contacts can create electrical resistance that can affect module operation.



WARNING: When you connect or disconnect the removable terminal block (RTB) with field-side power applied, an electric arc can occur. This could cause an explosion in hazardous location installations. Be sure that power is removed or the area is nonhazardous before proceeding.

Before You Begin

Before you install the controller, verify that you have these components:

Component	Description
1756 ControlLogix Chassis, Series C	Install a 1756 ControlLogix chassis. See publication 1756-IN621
1756 ControlLogix power supply for the chassis	Install a 1756 ControlLogix power supply. See publication 1756-IN619
GuardLogix® 5580 controller or Compact GuardLogix 5380 controller	The 1756 ControlLogix 16-point sinking safety input module is compatible with: <ul style="list-style-type: none"> GuardLogix 5580 controllers as local or remote I/O Compact GuardLogix 5380 controllers as remote I/O only To install a GuardLogix 5580 controller in a local chassis, see publication 1756-IN048
1756 ControlLogix EtherNet/IP™ Communication Module (remote I/O only)	If this safety I/O module resides in a remote location, the remote chassis must include a 1756 ControlLogix EtherNet/IP Communication Module (not compatible with the 1756-EWEB communication module) To install the module, see publication 1756-IN050
24V DC SELV/PELV power supply for field-side power to the 1756-IB16S module	For Functional Safety applications, a SELV/PELV power supply is required for field-side power.
Removable terminal blocks (RTB)	You can use these RTBs: <ul style="list-style-type: none"> 1756-TBCHS Cage-clamp removable terminal block with standard housing, 36-pin 1756-TBS6HS Spring-clamp removable terminal block with standard housing, 36-pin 1756-TBES Extended-depth terminal block housing. Requires the underlying connector For more information on terminal block torque specifications, see Terminal block torque specs on page 7
Tools	You use the following tools to wire the RTBs: <ul style="list-style-type: none"> Screwdriver Wire stripper Wires For more information on available wire sizes and wire insulation-stripping length, see Wire Size on page 7
1756 ControlLogix Digital Safety I/O Modules User Manual, publication 1756-UM013	Provides information about how to wire the 1756-IB16S safety I/O module

About the Module

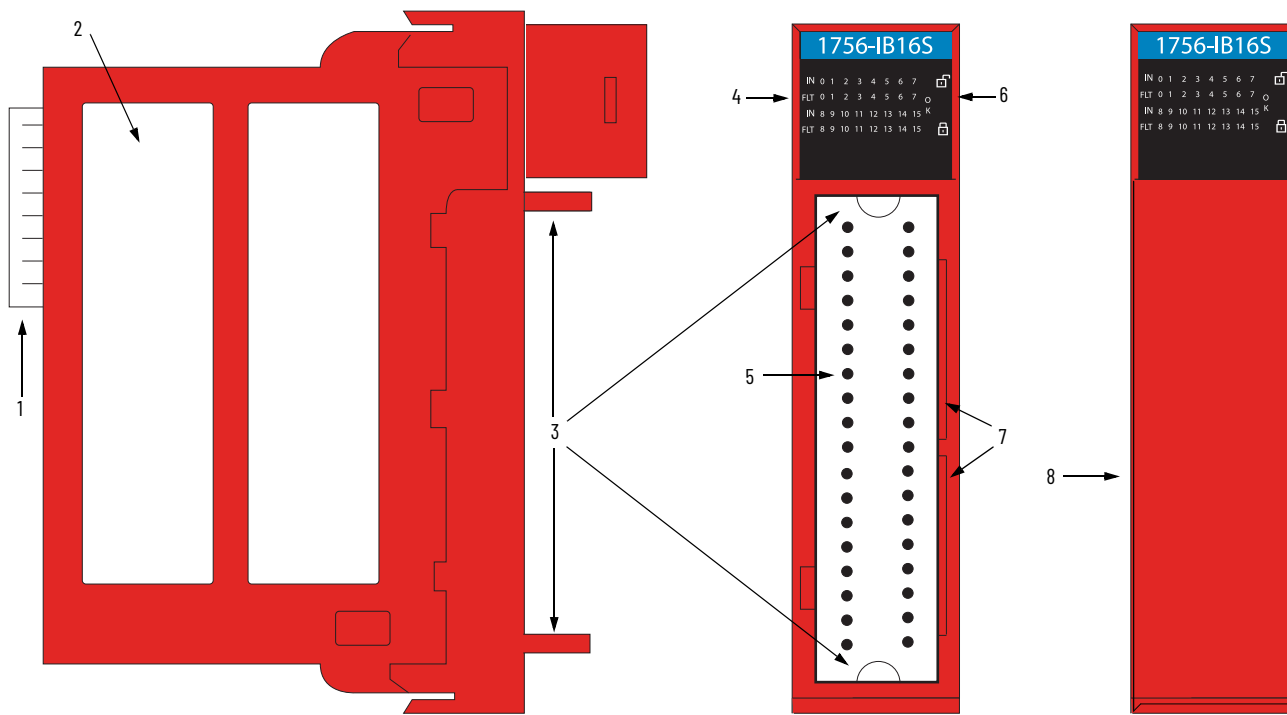

Item	Description
1	Backplane Connector - Interface for the ControlLogix system that connects the module to the backplane
2	QR Code - The module has a tear-off QR Code on the side of the module that contains the catalog number, series, serial number, and date of manufacture for the module.
3	Top and bottom guides - Guides provide assistance in seating the removable terminal block (RTB) onto the module
4	Status indicators - Indicators display the status of communication, module health, and input/output devices. Indicators help in troubleshooting anomalies
5	Connector pins - Input/output, power, and grounding connections are made to the module through these pins with the use of an RTB
6	Locking tab - The locking tab anchors the RTB on the module, maintaining wiring connections
7	Slots for keying - Mechanically keys the RTB to help prevent making the wrong wire connections to your module
8	Module with RTB installed

Install the Module



ATTENTION: The 1756-IB16S module is compatible with a Series C ControlLogix chassis. Do not install the input module in a Series B ControlLogix chassis.



ATTENTION: The module is designed to support removal and insertion under power (RIUP). However, when you remove or insert a removable terminal block (RTB) with field-side power applied, unintended machine motion or loss of process control can occur. Exercise extreme caution when using this feature. We recommend that you remove field-side power before installing the RTB onto the module.



SHOCK HAZARD: If the RTB is installed onto the module while the field-side power is applied, the RTB is electrically live. Do not touch the RTB terminals. Failure to observe this caution may result in personal injury.

1. Remove the tear-off QR Code from the side of the module.
2. Slide the module into the slot in the chassis until the locking tabs click.

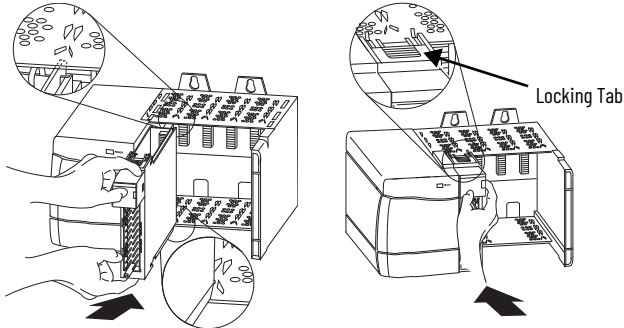

3. Install the QR Code on a visible surface, such as on the top of the module, in front of the locking tab.

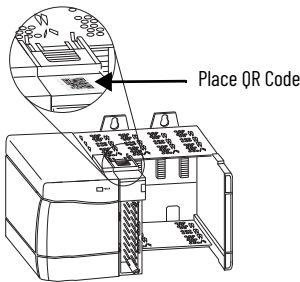

Key the Removable Terminal Block (RTB)

Key the RTB to help prevent connecting the incorrect RTB to your module.

1. Push the U-shaped band onto the module until the band snaps into place.
2. Insert wedge-shaped tabs into positions on the RTB that correspond to unkeyed module positions on the module until they stop.

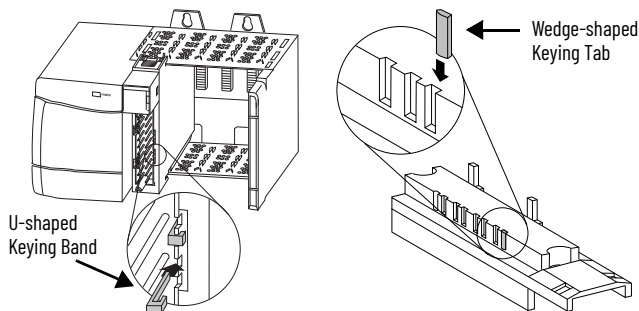

Connect Wiring

To connect wires to the RTB, see [Recommendations for Wiring Your RTB](#).



ATTENTION: When using the 1756-TBCHS RTBs, do not wire more than two 0.33...2.1 mm² (22...14 AWG) conductors on any terminal. Use only the same size wires with no intermixing of solid and stranded wire types. When using the 1756-TBS6HS RTBs, do not wire multiple 0.33...2.1 mm² (22...14 AWG) conductors on any terminal.



ATTENTION: The ControlLogix system has been agency certified using only the ControlLogix RTBs (1756-TBCHS or 1756-TBS6HS). Any application that requires agency certification of the ControlLogix system by using other wiring termination methods may require application-specific approval by the certifying agency.



WARNING: If you connect or disconnect wiring while the field-side power is on, an electric arc can occur. This could cause an explosion in hazardous location installations. Be sure that power is removed or the area is nonhazardous before proceeding.



ATTENTION: If multiple power sources are used, do not exceed the specified isolation voltage.

Wire a Cage Clamp-style RTB

1. Insert the wire into the terminal.
2. Turn the screw clockwise to close the terminal on the wire.

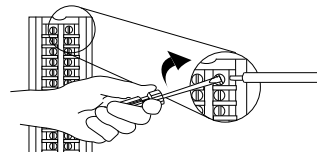

Wire a Spring Clamp

1. Insert the screwdriver into the outer hole of the RTB.
2. Insert the wire into the open terminal and remove the screwdriver.

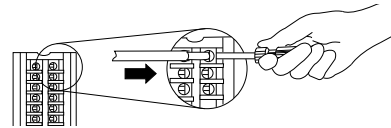

Recommendations for Wiring Your RTB

We recommend that you follow these guidelines when wiring your RTB:

- For information about how to wire the safety input module, see the *1756 ControlLogix Digital Safety I/O Modules User Manual*, publication [1756-UM013](#).
- Begin wiring the RTB at the bottom terminals and move up.
- Use a tie to secure the wires in the strain relief (bottom) area of the RTB.
- Order and use an extended-depth housing (catalog number 1756-TBES) for applications that require heavy-gauge wiring.

Assemble the RTB and the Housing

A removable housing covers the wired RTB to help protect wiring connections when the RTB is seated on the module.

1. Align the grooves at the bottom of each side of the housing with the side edges of the RTB.
2. Slide the RTB into the housing until it snaps into place.

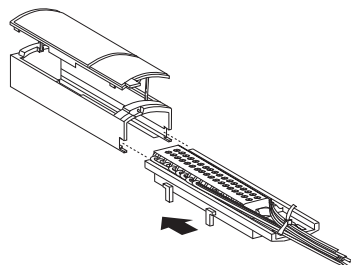

IMPORTANT If additional wire routing space is required for your application, use the extended-depth housing, catalog number 1756-TBES.

IMPORTANT The housings that are shown are used with a cage clamp RTB, but the capacity for each remains the same regardless of RTB type.

Install the RTB



WARNING: When you connect or disconnect the RTB with field-side power applied, an electric arc can occur. This could cause an explosion in hazardous location installations. Be sure that power is removed or the area is nonhazardous before proceeding.

Before installing the RTB, verify the following:

- Field-side wiring of the RTB is complete.
- The RTB housing is snapped into place on the RTB.
- The RTB housing door is closed.
- The locking tab at the top of the module is unlocked.

Follow these steps to install the RTB onto the module to connect the wiring.

1. Align the top, bottom, and left guides of the RTB with the guides on the module.

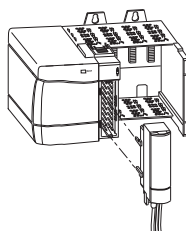

2. Press quickly and evenly to seat the RTB on the module until the latches snap into place.
3. Slide the locking tab down to lock the RTB onto the module.

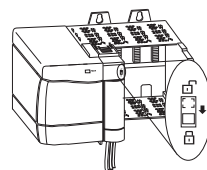

Specifications

Attribute	1756-IB16S
Voltage and current ratings	Backplane: 5.1V DC, 280 mA Field: 18...32V DC 1.8 A SELV/PELV IN: 10...32 V DC 2.5 mA SELV/PELV 150VA TO: 18...32V DC 200 mA
Temperature, operating IEC 60068-2-1 (Test Ad, Operating Cold) IEC 60068-2-2 (Test Bd, Operating Dry Heat) IEC 60068-2-14 (Test Nb, Operating Thermal Shock)	0 °C ≤ Ta ≤ 60 °C (32 °F ≤ Ta ≤ 140 °F)
Temperature, surrounding air, max	60 °C (140 °F)
Enclosure type rating	None (open-style)
Isolation voltage	60V (continuous), basic insulation type, channels-to-backplane No isolation between DC power and channels No isolation between individual ports
Wire Size	1756-TBCHS Single wire connection: 0.33...2.1 mm ² (22...14 AWG) solid or stranded shielded copper wire that is rated at 105 °C (221 °F), or greater, 1.2 mm (3/64 in.) insulation max. Double wire connection: 0.33...1.3 mm ² (22...16 AWG) solid or stranded copper wire that is rated at 105 °C (221 °F), or greater, 1.2 mm (3/64 in.) insulation max. Use only the same size wires with no intermixing of solid and stranded wire types. 1756-TBS6HS Single wire connection: 0.33...2.1 mm ² (22...14 AWG) solid or stranded shielded copper wire that is rated at 105 °C (221 °F), or greater, 1.2 mm (3/64 in.) insulation max.
Terminal block torque specs	1756-TBCHS 0.5 N·m (4.4 lb-in)
Temperature code	T4

Additional Resources

These resources contain information about related products from Rockwell Automation.

Resource	Description
ControlLogix I/O Modules Specifications Technical Data, publication 1756-TD002	Provides specifications, wiring diagrams, and schematics for ControlLogix I/O modules.
1756 ControlLogix Digital Safety I/O Modules User Manual, publication 1756-UM013	Provides installation, configuration, operation, and maintenance information for ControlLogix Digital Safety I/O modules.
ControlLogix 5580 and GuardLogix 5580 Controllers User Manual, publication 1756-UM543	Provides information on how to configure, program, and use ControlLogix 5580 controllers and GuardLogix 5580 controllers in Studio 5000 Logix Designer® application projects.
CompactLogix 5380 and Compact GuardLogix 5380 Controller User Manual, publication 5069-UM001	Provides information on how to install, configure, program, and use CompactLogix™ 5380 controllers and Compact GuardLogix 5380 controllers.
GuardLogix 5580 and Compact GuardLogix 5380 Controller Systems Safety Reference Manual, publication 1756-RM012	Provides information on how to achieve and maintain Safety Integrity Level (SIL) and Performance Level (PL) safety application requirements for GuardLogix 5580 and Compact GuardLogix 5380 controllers.
Safety Automation Builder and SISTEMA Library	Download Safety Automation Builder® software to help simplify machine safety design and validation, and reduce time and costs. Integration with our risk assessment software provides you with consistent, reliable, and documented management of the Functional Safety Lifecycle. The SISTEMA tool, also available for download from the Safety Automation Builder page, automates calculation of the attained Performance Level from the safety-related parts of a machine's control system to (EN) ISO 13849-1.
Industrial Automation Wiring and Grounding Guidelines, publication 1770-4.1	Provides general guidelines for installing a Rockwell Automation industrial system.
Product Certifications website, rok.auto/certifications	Provides declarations of conformity, certificates, and other certification details.

Waste Electrical and Electronic Equipment (WEEE)







At the end of life, this equipment should be collected separately from any unsorted municipal waste.

Rockwell Automation maintains current product environmental compliance information on its website at rok.auto/pec.

Your comments help us serve your documentation needs better. If you have any suggestions on how to improve our content, complete the form at rok.auto/docfeedback.

For technical support, visit rok.auto/support.

Rockwell Otomasyon Ticaret A.Ş. Kar Plaza İş Merkezi E Blok Kat:6 34752, Çerçenköy, İstanbul, Tel: +90 (216) 5698400 EEE Yönetmeliğine Uygundur

Connect with us.    

rockwellautomation.com

expanding human possibility®

AMERICAS: Rockwell Automation, 1201 South Second Street, Milwaukee, WI 53204-2496 USA, Tel: (1) 414.382.2000, Fax: (1) 414.382.4444

EUROPE/MIDDLE EAST/AFRICA: Rockwell Automation NV, Pegasus Park, De Kleetlaan 12a, 1831 Diegem, Belgium, Tel: (32) 2 663 0600, Fax: (32) 2 663 0640

ASIA PACIFIC: Rockwell Automation, Level 14, Core F, Cyberport 3, 100 Cyberport Road, Hong Kong, Tel: (852) 2887 4788, Fax: (852) 2508 1846

UNITED KINGDOM: Rockwell Automation Ltd, Pitfield, Kiln Farm Milton Keynes, MK11 3DR, United Kingdom, Tel: (44)(1908) 838-800, Fax: (44)(1908) 261-917

Allen-Bradley, CompactLogix, ControlLogix, GuardLogix, expanding human possibility, Rockwell Automation, Safety Automation Builder, and Studio 5000 Logix Designer are trademarks of Rockwell Automation, Inc.

EtherNet/IP is a trademarks of ODVA, Inc.

Trademarks not belonging to Rockwell Automation are property of their respective companies.

Publication 1756-IN079E-EN-P - April 2023 | Supersedes Publication 1756-IN079D-EN-P - June 2021

Copyright © 2023 Rockwell Automation, Inc. All rights reserved. Printed in the U.S.A.

PN-685605