

Surestep[®]

Stepping Systems User Manual

Manual #: STP-SYS-M-WO
7th Edition, Rev E

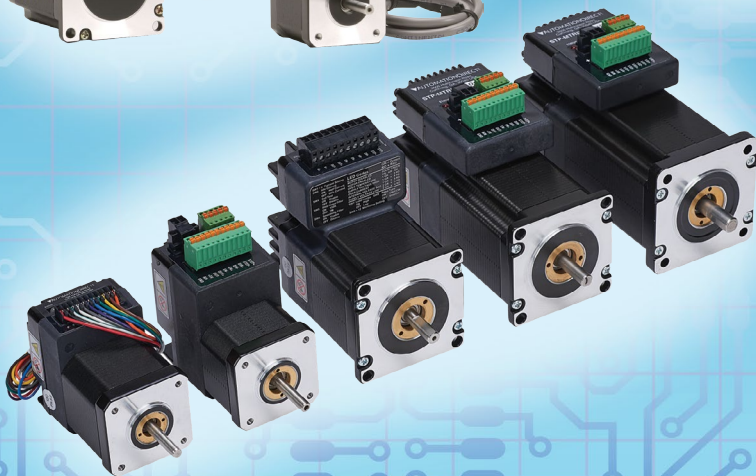
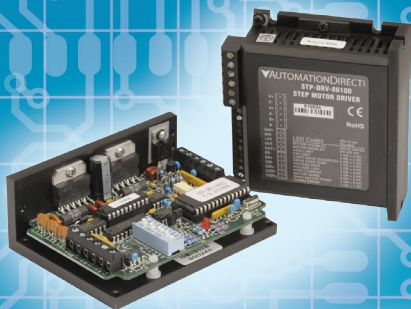

**BLANK
PAGE**

~ WARNING ~

Thank you for purchasing automation equipment from Automationdirect.com®, doing business as AutomationDirect. We want your new automation equipment to operate safely. Anyone who installs or uses this equipment should read this publication (and any other relevant publications) before installing or operating the equipment.

To minimize the risk of potential safety problems, you should follow all applicable local and national codes that regulate the installation and operation of your equipment. These codes vary from area to area and usually change with time. It is your responsibility to determine which codes should be followed, and to verify that the equipment, installation, and operation is in compliance with the latest revision of these codes.

At a minimum, you should follow all applicable sections of the National Fire Code, National Electrical Code, and the codes of the National Electrical Manufacturer's Association (NEMA). There may be local regulatory or government offices that can also help determine which codes and standards are necessary for safe installation and operation.

Equipment damage or serious injury to personnel can result from the failure to follow all applicable codes and standards. We do not guarantee the products described in this publication are suitable for your particular application, nor do we assume any responsibility for your product design, installation, or operation.

Our products are not fault-tolerant and are not designed, manufactured or intended for use or resale as on-line control equipment in hazardous environments requiring fail-safe performance, such as in the operation of nuclear facilities, aircraft navigation or communication systems, air traffic control, direct life support machines, or weapons systems, in which the failure of the product could lead directly to death, personal injury, or severe physical or environmental damage ("High Risk Activities"). AutomationDirect specifically disclaims any expressed or implied warranty of fitness for High Risk Activities.

For additional warranty and safety information, see the Terms and Conditions section of our catalog. If you have any questions concerning the installation or operation of this equipment, or if you need additional information, please call us at 770-844-4200.

This publication is based on information that was available at the time it was printed. At AutomationDirect we constantly strive to improve our products and services, so we reserve the right to make changes to the products and/or publications at any time without notice and without any obligation. This publication may also discuss features that may not be available in certain revisions of the product.

Trademarks

This publication may contain references to products produced and/or offered by other companies. The product and company names may be trademarked and are the sole property of their respective owners. AutomationDirect disclaims any proprietary interest in the marks and names of others.

**Copyright 2004-2025 - Automationdirect.com® Incorporated
All Rights Reserved**

No part of this manual shall be copied, reproduced, or transmitted in any way without the prior, written consent of Automationdirect.com® Incorporated. AutomationDirect retains the exclusive rights to all information included in this document.

~ AVERTISSEMENT ~

Nous vous remercions d'avoir acheté l'équipement d'automatisation de AutomationDirect.com®, en faisant des affaires comme AutomationDirect. Nous tenons à ce que votre nouvel équipement d'automatisation fonctionne en toute sécurité. Toute personne qui installe ou utilise cet équipement doit lire la présente publication (et toutes les autres publications pertinentes) avant de l'installer ou de l'utiliser.

Afin de réduire au minimum le risque d'éventuels problèmes de sécurité, vous devez respecter tous les codes locaux et nationaux applicables régissant l'installation et le fonctionnement de votre équipement. Ces codes diffèrent d'une région à l'autre et, habituellement, évoluent au fil du temps. Il vous incombe de déterminer les codes à respecter et de vous assurer que l'équipement, l'installation et le fonctionnement sont conformes aux exigences de la version la plus récente de ces codes.

Vous devez, à tout le moins, respecter toutes les sections applicables du Code national de prévention des incendies, du Code national de l'électricité et des codes de la National Electrical Manufacturer's Association (NEMA). Des organismes de réglementation ou des services gouvernementaux locaux peuvent également vous aider à déterminer les codes ainsi que les normes à respecter pour assurer une installation et un fonctionnement sûrs.

L'omission de respecter la totalité des codes et des normes applicables peut entraîner des dommages à l'équipement ou causer de graves blessures au personnel. Nous ne garantissons pas que les produits décrits dans cette publication conviennent à votre application particulière et nous n'assumons aucune responsabilité à l'égard de la conception, de l'installation ou du fonctionnement de votre produit.

Nos produits ne sont pas insensibles aux défaillances et ne sont ni conçus ni fabriqués pour l'utilisation ou la revente en tant qu'équipement de commande en ligne dans des environnements dangereux nécessitant une sécurité absolue, par exemple, l'exploitation d'installations nucléaires, les systèmes de navigation aérienne ou de communication, le contrôle de la circulation aérienne, les équipements de survie ou les systèmes d'armes, pour lesquels la défaillance du produit peut provoquer la mort, des blessures corporelles ou de graves dommages matériels ou environnementaux («activités à risque élevé»). La société AutomationDirect nie toute garantie expresse ou implicite d'aptitude à l'emploi en ce qui a trait aux activités à risque élevé.

Pour des renseignements additionnels touchant la garantie et la sécurité, veuillez consulter la section Modalités et conditions de notre documentation. Si vous avez des questions au sujet de l'installation ou du fonctionnement de cet équipement, ou encore si vous avez besoin de renseignements supplémentaires, n'hésitez pas à nous téléphoner au 770-844-4200.

Cette publication s'appuie sur l'information qui était disponible au moment de l'impression. À la société AutomationDirect, nous nous efforçons constamment d'améliorer nos produits et services. C'est pourquoi nous nous réservons le droit d'apporter des modifications aux produits ou aux publications en tout temps, sans préavis ni quelque obligation que ce soit. La présente publication peut aussi porter sur des caractéristiques susceptibles de ne pas être offertes dans certaines versions révisées du produit.

Marques de commerce

La présente publication peut contenir des références à des produits fabriqués ou offerts par d'autres entreprises. Les désignations des produits et des entreprises peuvent être des marques de commerce et appartiennent exclusivement à leurs propriétaires respectifs. AutomationDirect nie tout intérêt dans les autres marques et désignations.

Copyright 2004-2025 – AutomationDirect.com® Incorporated
Tous droits réservés

Nulle partie de ce manuel ne doit être copiée, reproduite ou transmise de quelque façon que ce soit sans le consentement préalable écrit de la société AutomationDirect.com® Incorporated. AutomationDirect conserve les droits exclusifs à l'égard de tous les renseignements contenus dans le présent document.

~ WARNING ~



WARNING: Read this manual thoroughly before using SureStep™ Stepping System drives, motors, and power supplies.



WARNING: AC input power must be disconnected before performing any maintenance. Do not connect or disconnect wires or connectors while power is applied to the circuit. Maintenance must be performed only by a qualified technician.



WARNING: There are highly sensitive MOS components on the printed circuit boards, and these components are highly sensitive to static electricity. To avoid damage to these components, do not touch the components or the circuit boards with metal objects or with your bare hands.



WARNING: Ground the SureStep™ power supply using the ground terminal. The grounding method must comply with the laws of the country where the equipment is to be installed. Refer to "Power Supply Terminal & Component Layout" in the Power Supply chapter.

**BLANK
PAGE**

SURESTEP™

STEPPING SYSTEMS

USER MANUAL

Please include the Manual Number and the Manual Issue, both shown below, when communicating with Technical Support regarding this publication.

Manual Number: STP-SYS-M-WO
Issue: Seventh Edition, Revision E
Issue Date: 04/08/2025

Publication History		
Issue	Date	Description of Changes
First Edition	7/28/04	Original
1st Ed, Rev A	8/26/04	AC power fuse changed from 2A slow blow to 3A fast acting, plus other minor changes and corrections.
1st Ed, Rev B	3/28/07	Added wiring diagrams for both sink and source for indexers and PLCs with 12-24 VDC outputs. Also corrected value for r^4 from 64 to 1296 in formula under Step 4 on page 15 of Appendix A.
Second Edition	11/2008	Changed name of user manual (was STP-SYS-M). Added new components: 3 new power supplies: STP-PWR-4805, -4810, -7005 2 new drives: STP-DRV-4850, -80100 5 new motors: STP-MTR-17040, STP-MTRH-23079, -34066, -34097, -34127 2 new cables: STP-EXTH-020, STP-232RJ11-CBL Other minor changes throughout.
2nd Ed, Rev A	06/2009	Advanced drives RS-232 communication port pin-out; pages 3-4 & B-7
2nd Ed, Rev B	09/2009	Advanced drives Digital Output max current rating; page 3-10
2nd Ed, Rev C	02/2011	Ch 2,3: drive storage temperature specs Ch 4: motor storage temperature specs; motor Torque vs Speed curves Ch 5: power supply Watt loss specs
2nd Ed, Rev D	11/2011	Ch 2: RoHS, Wiring for Encoder Following Ch 3: Connection Locations & Pin-out; Wiring for Encoder Following Appx B: PLC connection diagrams
2nd Ed, Rev E	02/2012	Appx B: PLC connection diagrams
Third Edition	09/2012	Ch 1,4: Added new STP-MTR(H)-xxxxx(D) dual-shaft motors
Fourth Edition	12/2012	Added new drive STP-DRV-6575 & accessories; chapter renumberings
Fifth Edition	07/2018	Manual update throughout for Integrated Motors/Drives additions. New Chapter 5, 8, and 9 added.

Publication History, continued

Issue	Date	Description of Changes
5th Ed, Rev A	10/2018	Addition of SureStep Encoders and NEMA 14 motors.
5th Ed, Rev B	01/2019	Addition of SureStep IP65 motors.
Sixth Edition	11/2019	Addition of AC drives and step motors.
Seventh Edition	04/2020	Addition of CUI encoders
7th Ed, Rev A	06/2020	Chapter 6: Update sourcing output connection diagram Appendix B: Change serial connection diagram comm port from RJ12 to RJ11
7th Ed, Rev B	11/2020	Addition of Linear SureStep Actuators.
7th Ed, Rev C	06/2021	Addition of NEMA 42 MTRAC(H) motors.
7th Ed, Rev D	03/2022	Change of factory default for jumper S4 on STP-DRV-4845 and STP-DRV-6575 from 150kHz to 2MHz.
7th Ed, Rev E	04/2025	Changed CUI Devices to Same Sky brand. Part numbers unchanged. Incremental minor fixes throughout manual.

SURESTEP™

STEPPING SYSTEMS

USER MANUAL

TABLE OF CONTENTS

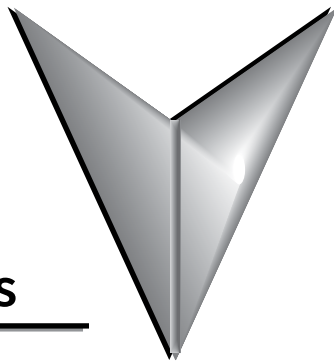

Warnings	W-1
Chapter 1: Getting Started	1-1
Manual Overview	1-2
Overview of this Publication	1-2
Who Should Read this Manual	1-2
Technical Support	1-2
Special Symbols	1-2
SureStep™ System Introduction	1-3
SureStep™ Part Number Explanation	1-3
SureStep™ System Recommended Component Compatibility	1-5
Drive and Motor Compatibility	1-6
Microstepping Drives Introduction	1-9
Standard Microstepping Drives	1-9
High Bus Voltage Microstepping Drives	1-11
Advanced Microstepping Drive	1-12
Standard Integrated Motors/Drives	1-13
Advanced Integrated Motors/Drives	1-14
Step Motor Introduction	1-15
Stepping System Power Supply Introduction	1-16
Selecting the Stepping System	1-17
Use with AutomationDirect PLCs	1-17
High-Speed Pulse Output Control (Standard Drives)	1-17
Serial Communication Control (Advanced Drives)	1-17
Chapter 2: SureStep STP-DRV-4830,-4845,-6575 Standard DC	
Microstepping Drive	2-1
Features	2-2
Specifications	2-3
Typical Wiring Diagram	2-5
Wiring Connections and Configuration Switches	2-5

STP-DRV-4830	2-5
STP-DRV-4845 and STP-DRV-6575	2-6
Connecting the Motor	2-7
Connecting the Power Supply	2-8
SureStep™ Drive Digital Inputs and Outputs	2-9
Connecting the Input Signals: STEP and DIR	2-9
Connecting the Input Signals – EN Input	2-10
Connecting the Fault Output	2-11
Drive Configuration	2-12
Drive Configurations Settings	2-12
DIP Switch Settings	2-13
Alarm Codes	2-16
Mounting the Drive	2-19
Drive Heating	2-19
Dimensions and Mounting Slot Locations	2-19
STP-DRV-4830	2-19
STP-DRV-4845 and STP-DRV-6575	2-20
Chapter 3: SureStep STP-DRV-4035 Microstepping Drive	3-1
Features	3-2
Specifications	3-3
Typical Wiring Diagram	3-4
Connection and Adjustment Locations	3-4
Connecting the Motor	3-5
Connecting the Power Supply	3-6
Connecting the Logic	3-7
Using Logic That is Not 5 volt TTL Level	3-9
The Enable Input	3-9
Setting Phase Current	3-10
Current Setting Formula	3-10
Current Setting Table	3-11
Microstepping	3-12
Idle Current Reduction	3-13
Self Test	3-13
Dimensions	3-15
Chapter 4: SureStep Advanced Microstepping Drives	4-1
Features	4-2
Specifications	4-3
Typical Wiring Diagram	4-4

Connection Locations & Pin-out	4-4
Connecting the Power Supply	4-6
Connecting the I/O	4-7
SureStep™ Drive Digital Inputs	4-7
Connecting STEP and DIR to 5V TTL Logic	4-7
Connecting STEP and DIR to Logic Other Than 5V TTL Level	4-8
Connections to the EN Input	4-9
Connecting the Analog Input	4-10
Connecting the Digital Output	4-10
LED Display Codes	4-12
Drive Configuration	4-15
Mounting the Drive	4-17
Drive Heating	4-17
Dimensions and Mounting Slot Locations	4-17
Chapter 5: SureStep STP-DRVAC-24025 Microstepping Drive	5-1
Features	5-2
Specifications	5-3
Mounting the Drive	5-4
Dimensions	5-4
Wiring Connections and Configuration Switches	5-5
STP-DRVAC-24025	5-5
Connecting the Power Supply	5-6
Connecting the Motor	5-7
Selecting the Motor	5-8
Connecting the I/O	5-9
Step/Direction Mode and CW/CCW Mode Jumper	5-9
Connecting the Input Signals - Step and Direction	5-9
The Enable Input	5-10
Connecting the Fault Output Setting	5-11
Drive Configuration	5-12
Microstepping	5-13
Setting Running Current	5-13
Idle Current Reduction	5-14
Step Noise Filter	5-14
Load Inertia	5-14
Smoothing Filter	5-14
Self Test	5-15
Alarm Codes	5-16

Chapter 6: SureStep Integrated Motors/Drives.....	6-1
Features	6-3
General Features:.....	6-3
Standard Drive Features	6-3
Advanced Drive Features	6-3
Features Comparison	6-4
Specifications	6-5
Getting Started	6-11
Installing Software	6-11
Mounting	6-11
Additional Reading.....	6-12
Mating Connectors and Accessories	6-12
Using a Regulated Power Supply	6-17
LED Error Codes	6-18
STP-MTRD Inputs and Outputs	6-22
Input/Output Functions	6-25
The Step (STEP) and Direction (DIR) Inputs.....	6-26
The Enable (EN/IN3) Digital Input.....	6-28
The Analog (AIN) Input	6-29
The Digital Output	6-30
Using the Optional Encoder.....	6-31
Configuring the Standard STP-MTRD	6-32
Drive/Motor Heating	6-37
Torque Speed Graphs	6-40
Dimensions and Mounting Slot Locations	6-43
Chapter 7: SureStep Stepping Motors.....	7-1
Features	7-2
Design and Installation Tips	7-3
Specifications	7-4
Power Supply and Step Motor Drive	7-8
Mounting the Motor.....	7-8
Connecting the Motor	7-8
Extension Cable Wiring Diagrams.....	7-9
Connecting a STP-MTRAC-23x or STP-MTRAC-34x Motor	7-10
Connecting a STP-MTRAC(H)-42 Motor.....	7-11
Motor Dimensions and Cabling.....	7-12
Typical Dimension & Cable Diagrams	7-12
Typical Dimension & Cable Diagram for STP-MTRH.....	7-15

Typical Dimension & Cable Diagram for STP-MTRAC.....	7-18
Typical Dimension & Cable Diagram for STP-MTRAC(H)-42x.....	7-20
Torque vs. Speed Charts.....	7-21
Chapter 8: SureStep Linear Actuators.....	8-1
Features.....	8-2
Design and Installation Tips.....	8-3
Model Number Explanation.....	8-3
Specifications.....	8-4
Power Supply and Step Motor Drive.....	8-8
Mounting the Motor.....	8-8
Journal Mounting.....	8-8
Connecting the Motor.....	8-10
Extension Cable Wiring Diagrams.....	8-10
Motor Dimensions and Cabling.....	8-12
Thrust vs. Speed Charts.....	8-16
Chapter 9: SureStep System Power Supplies.....	9-1
Features.....	9-2
Specifications.....	9-3
Drive Heating.....	9-4
Choosing a Power Supply.....	9-5
Power Supply Terminal & Component Layout.....	9-7
Mounting the Power Supply.....	9-8
Dimensions.....	9-9
Dimensions (continued).....	9-10
Chapter 10: SureMotion Pro Configuration Software.....	10-1
SureMotion™ Pro Software.....	10-2
Communication.....	10-2
Motor Configuration.....	10-2
Motion and I/O.....	10-3
Drive Pull-down Menu.....	10-4
Chapter 11: SureStep Communications.....	11-1
Connecting to a Host Using RS-485.....	11-2
Four-Wire Configuration.....	11-2
Two-Wire Configuration.....	11-3
Assigning RS-485 Addresses.....	11-3
Connecting to an STP-MTRD-xxxxR using the STP-USB485-4W Adapter.....	11-4
Connecting to a drive using RJ12.....	11-5

Appendix A: Accessories	A-1
Braking Accessories	A-2
Regeneration Clamp Features	A-2
Cables and Accessories	A-5
Encoder Options	A-10
Encoder Mounting Accessories	A-15
Encoder Specifications	A-16
Differential Electrical Specifications	A-18
Wiring Examples	A-19
Line Filters	A-24
Appendix B: Using SureStep with AutomationDirect PLCs	B-1
Compatible AutomationDirect PLCs and Modules	B-2
Typical Connections to a Productivity PLC	B-6
Typical Connections to a DL05 PLC	B-7
Typical Connections to an H0-CTRIO	B-8
Typical Connections – Multiple Drives/Motors	B-9
Typical <i>Direct</i> LOGIC PLC RS-232	
Serial Connections to an Advanced SureStep Drive	B-10
Typical CLICK, P-Series, & BRX PLC RS-232	
Serial Connections to an Advanced SureStep Drive	B-11
Typical RS-485 Connections to	
Integrated Motor/Drives	B-12
Appendix C: Selecting the SureStep Stepping System	C-1
Selecting the SureStep™ Stepping System	C-2
The Selection Procedure	C-2
How many pulses from the PLC to make the move?	C-2
What is the positioning resolution of the load?	C-3
What is the indexing speed to accomplish the move time?	C-3
Calculating the Required Torque	C-4
Leadscrew – Example Calculations	C-8
Step 1 – Define the Actuator and Motion Requirements	C-8
Step 2 – Determine the Positioning Resolution of the Load	C-9
Step 3 – Determine the Motion Profile	C-9
Step 4 – Determine the Required Motor Torque	C-9
Step 5 – Select & Confirm the Stepping Motor & Driver System	C-10
Belt Drive – Example Calculations	C-15
Step 1 – Define the Actuator and Motion Requirements	C-15
Step 2 – Determine the Positioning Resolution of the Load	C-16

Step 3 – Determine the Motion Profile	C-16
Step 4 – Determine the Required Motor Torque.....	C-16
Step 5 – Select & Confirm the Stepping Motor & Driver System	C-17
Index Table – Example Calculations	C-19
Step 1 – Define the Actuator and Motion Requirements.....	C-19
Step 2 – Determine the Positioning Resolution of the Load	C-19
Step 3 – Determine the Motion Profile	C-20
Step 4 – Determine the Required Motor Torque.....	C-20
Step 5 – Select & Confirm the Stepping Motor & Driver System	C-21
Engineering Unit Conversion Tables, Formulae, & Definitions:	C-22

BLANK
PAGE

GETTING STARTED



CHAPTER 1

In This Chapter...

Manual Overview	1-2
Overview of this Publication	1-2
Who Should Read this Manual	1-2
Technical Support	1-2
Special Symbols	1-2
SureStep™ System Introduction	1-3
SureStep™ Part Number Explanation	1-3
SureStep™ System Recommended Component Compatibility	1-5
Microstepping Drives Introduction	1-9
Standard Microstepping Drives	1-9
High Bus Voltage Microstepping Drives	1-11
Advanced Microstepping Drive	1-12
Standard Integrated Motors/Drives	1-13
Advanced Integrated Motors/Drives	1-14
Step Motor Introduction	1-15
Stepping System Power Supply Introduction	1-16
Selecting the Stepping System	1-17
Use with AutomationDirect PLCs	1-17
High-Speed Pulse Output Control (Standard Drives)	1-17
Serial Communication Control (Advanced Drives)	1-17

Manual Overview

Overview of this Publication

Thank you for selecting the SureStep™ Stepping System components. This user manual describes the selection, installation, configuration, and methods of operation of the SureStep™ Stepping System. We hope our dedication to performance, quality and economy will make your motion control project successful.

Who Should Read this Manual

This manual contains important information for those who will install, maintain, and/or operate any of the SureStep™ Stepping System devices.

Technical Support

By Telephone: 770-844-4200
(Mon.-Fri., 9:00 am – 6:00 pm E.T.)

On the Web: www.automationdirect.com

Our technical support group is glad to work with you in answering your questions. If you cannot find the solution to your particular application, or, if for any reason you need additional technical assistance, please call technical support at **770-844-4200**. We are available weekdays from 9:00 am to 6:00 pm Eastern Time.

We also encourage you to visit our web site where you can find technical and non-technical information about our products and our company. Visit us at **www.automationdirect.com**.

Special Symbols



When you see the "notepad" icon in the left-hand margin, the paragraph to its immediate right will be a special note which presents information that may make your work quicker or more efficient.



*When you see the "exclamation mark" icon in the left-hand margin, the paragraph to its immediate right will be a **WARNING**. This information could prevent injury, loss of property, or even death (in extreme cases).*

SureStep™ System Introduction

SureStep open-loop and inclusive position verification (semi-closed loop) stepping systems provide simple and accurate control of position and speed where lower power and cost are considerations. The SureStep family of stepping components includes power supplies, drives, motors, and cables. The AutomationDirect family of PLCs or other indexers and motion controllers can be used to provide the signals that are “translated” by the microstepping drives into precise movement of the stepping motor shaft.

SureStep™ Part Number Explanation

Drives

STP-DRV-6575

Component Capacity

2-digit max nominal voltage followed by max current with 1 implied decimal place

4035: 40VDC, 3.5 A
 4830: 48VDC, 3.0 A
 4845: 48VDC, 4.5 A
 4850: 48VDC, 5.0 A
 6575: 65VDC, 7.5 A
 80100: 80VDC, 10.0 A
 24025: 120/240VAC, 2.5 A

Component Type

DRV: DC powered stepper drive
 DRVAC: AC powered stepper drive
 DRVA: drive accessory

SureStep Series Designation: STP

Motors

STP-MTRx-23079x

Motor Shaft Type/Variant

blank: single shaft
 D: dual shaft
 E: encoder pre-mounted
 W: IP65 (washdown)

Component Capacity

2-digit NEMA frame size followed by approximate stack* length in mm

Component Type

MTRL: low-power DC stepper motor
 MTR: high-power stepper motor
 MTRH: higher-power stepper motor
 MTRA: motor accessory
 MTRAC: high-bus voltage stepper motor**
 MTRACH: high-power high-bus voltage stepper motor

SureStep Series Designation: STP

* The length of the motor that produces torque (not including shaft)

** NEMA 23/34 motors optimized for use with DRVAC drives

Power Supplies

STP- PWR - 3204

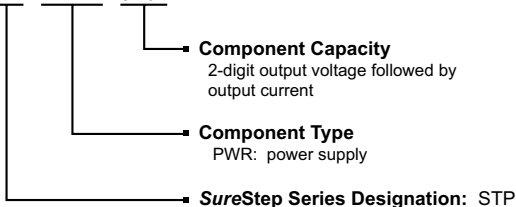

Integrated Motors/Drives

STP- MTRD - 23042 x

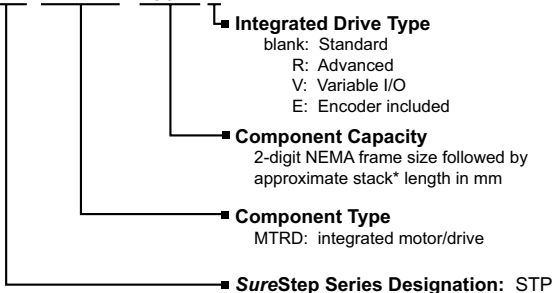

* The length of the motor that produces torque

Cables and Accessories

SureStep Cables & Accessories	
Part Number	Description
STP-EXTx-xx	Motor extension cable, xx = cable length in feet, x=H for high power, L for low power, W for IP65
STP-DRVA-xx	Drive accessory, xx= accessory descriptor
STP-MTRA-xx	Motor accessory, xx = accessory descriptor
<i>Note: See Appendix A for the full range of SureStep accessories</i>	

SureStep™ System Recommended Component Compatibility

SureStep Power Supply / DC Powered Drive Compatibility				
Drive (1)(2)(4)	Recommended Linear Power Supply (1)(2)(4)			
Model Number	STP-PWR -3024	STP-PWR -4805	STP-PWR -4810	STP-PWR -7005 ⁽³⁾
STP-DRV-4035 12-32 VDC input (40V max)	√	No	No	No
STP-DRV-4830 12-48 VDC Input (48V max)	√	√	√	No
STP-DRV-4845 24-48 VDC Input (48V max)	√	√	√	No
STP-DRV-4850 24-48 VDC input (48V max)	√	√	√	No
STP-DRV-6575 24-75 VDC input (85V max)	√	√	√	No
STP-DRV-80100 24-80 VDC input (80V max)	√	√	√	√
STP-MTRD-17 12-48 VDC input	√	√	√	No
STP-MTRD-23, -24 12-70 VDC input	√	√	√	√

1) Do NOT use a power supply that exceeds the drive's input voltage range. If using a non-STP linear power supply, ensure that the unloaded voltage does not float above the drive's maximum input range.

2) For best performance, use the lowest voltage power supply that supplies the required speed and torque.

3) An unloaded STP-PWR-7005 can float above the allowable input voltages of some drives if it is fed with a high AC input voltage (greater than 120VAC).

4) STP-DRVAC-x drives are AC powered and cannot be powered by DC power supplies. Please see Chapter 5 for use of AC power drives and motors.

SureStep Power Supply / Drive Compatibility			
Drive (1)(2)(3)	Recommended Switching Power Supply (1)(2)(3)		
Model Number	PSB12-xxxS	PSB24-xxxS	PSB48-xxxS
STP-DRV-4035 12-32 VDC input (40V max)	√	√	No
STP-DRV-4830 12-48 VDC input (48V max)	√	√	√
STP-DRV-4845 24-48 VDC input (48V max)	No	√	√
STP-DRV-4850 24-48 VDC input (48V max)	No	√	√
STP-DRV-6575 24-75 VDC input (85V max)	No	√	√
STP-DRV-80100 24-80 VDC input (80V max)	No	√	√
STP-MTRD-17 12-48 VDC input	√	√	√
STP-MTRD-23, -24 12-70 VDC input	√	√	√

1) Do NOT use a power supply that exceeds the drive's input voltage range.
 2) For best performance, use the lowest voltage power supply that supplies the required speed and torque.
 3) STP-DRVAC-x drives are AC powered and cannot be powered by DC power supplies. Please see Chapter 5 for use of AC power drives and motors.

Drive and Motor Compatibility

The following pages detail which SureStep drives are compatible with which SureStep motors.

Bipolar Steppers are very universal in their compatibility. If you would like to use SureStep motors with a different brand of drives (Leadshine, for example) or use SureStep drives with other motors, you need to follow some basic guidelines:

1. Ensure the drive can supply enough phase current to meet the motor's rated current. Example: we recommend STP-DRV-6575 (7.5 A max current) and STP-DRV-80100 (10A max current) to drive the STP-MTRH-34xxxx motors (6.3 A rated current). Technically, a smaller drive can power a larger motor, but the motor will not be able to produce its rated torque.
2. Ensure the applied drive voltage does not exceed the design voltage for the stepper motor. SureStep MTR motors are designed to be driven with drive input voltages less than 75VDC. MTRAC/MTRACH motors can also be driven by these low voltages, but are wound so that they can take advantage of higher voltages (110VAC or 220VAC drive input). The speed torque curves for high voltage input result in higher torque at much higher speeds. For a clear example, see the speed-torque curves for the NEMA 42 MTRAC/MTRACH motors. Compare the 24V torque curves for those motors vs the 160V curves. The higher voltage results in much higher speeds/torques.

SureStep DC Drive / Motor Compatibility ⁽³⁾								
Motor (1)			Recommended Drive (1)					
Model Number ⁽²⁾	Rated Amps (RMS) Bipolar Parallel wound	Extension Cable	STP-DRV-4035 (3.5 A max output)	STP-DRV-4830 (3.0 A max output)	STP-DRV-4845 (4.5 A max output)	STP-DRV-4850 (5.0 A max output)	STP-DRV-6575 (7.5 A max output)	STP-DRV-80100 (10.0 A max output)
			STP-MTRL-14026x	0.35	STP-EXTL-0xx	√	√	
STP-MTRL-14034x	0.8		√	√	√	√	-	-
STP-MTR-17040x	1.7	STP-EXTx-0xx	√	√	√	√	√	√
STP-MTR-17048x	2.0		√	√	√	√	√	√
STP-MTR-17060x	2.0		√	√	√	√	√	√
STP-MTR-23055x	2.8		√	√	√	√	√	√
STP-MTR-23079x	2.8		√	√	√	√	√	√
STP-MTR-34066x	2.8		√	√	√	√	√	√
STP-MTRH-23079x	5.6	STP-EXTHx-0xx	-				√	√
STP-MTRH-34066x	6.3						√	√
STP-MTRH-34097x	6.3						√	√
STP-MTRH-34127x	6.3						√	√

1) The combinations above will perform according to the published speed/torque curves. However, any STP motor can be used with any STP drive. Using a motor with a current rating higher than the drive's output rating will proportionally limit the motor torque.

2) MTR motors have connectors compatible with the EXT extension cables.
MTRH motors have connectors compatible with the EXTH extension cables.
MTRL motors have connectors compatible with the EXTL extension cables.
W-series motors have connectors compatible with the EXTW and EXTHW extension cables.

3) Not applicable to integrated motor/drives as drives and motors are already paired.

SureStep AC Motor/Drive Compatibility		
Model Number	STP-DRVAC-24025	
	Series Wired Motor	Parallel Wired Motor
STP-MTRAC-23044x	Yes	No
STP-MTRAC-23055x	Yes	No
STP-MTRAC-23078x	Yes	No
STP-MTRAC-34075x	Yes	No
STP-MTRAC-34115x	Yes	No
STP-MTRAC-34156x	Yes	No

Note: Always use series motor wiring with STP-DRVAC-24025. The drive has an internal voltage doubler circuit, so it will output a very high bus voltage if fed with 120VAC or 240VAC.

SureStep DC Drive / Motor Compatibility ⁽³⁾								
Motor				Recommended Drive				
Model Number	Rated Amps (RMS) Bipolar Parallel wound	Rated Amps (RMS) Bipolar Series wound	Rated Amps (RMS) Unipolar Series wound	Extension Cable	STP-DRV-4845 (4.5 A max output)	STP-DRV-4850 (5.0 A max output)	STP-DRV-6575 (7.5 A max output)	STP-DRV-80100 (10.0 A max output)
STP-MTRAC-42100x	8.4	4.2	6	STP- EXT42-x	√(1)	√(1)	√(1)	√
STP-MTRAC-42151x	12	6	9.4				√(1)	√(1)
STP-MTRAC-42202x	12	6	9				√(1)	√(1)
STP-MTRACH-42100x	12	6	8.5	STP- EXT42H-x			√(1)	√(1)
STP-MTRACH-42151x	16	8	11.3					√(1)
STP-MTRACH-42202x	16	8	11.5					√(1)

1) Series wound only

Note: The SureStep drives not listed on this table (STP-DRV-4035, STP-DRV-4830, STP-DRVAC-24025) do not supply enough current for the NEMA42 motors and will NOT work.

Unlike the smaller MTR motors, all 8 motor leads are available on the NEMA 42 motors. These motors can be wired in Bipolar Parallel, Bipolar Series, or Unipolar Series.

Microstepping Drives Introduction

There are two different basic types of microstepping drives offered in the SureStep™ series. DIP-switch configurable models with pulse inputs are available, as well as two software configurable advanced models with multiple operating modes. Descriptions of integrated motor/drives (a drive integrally attached to the motor) follow the drive-only section.

Standard Microstepping Drives

STP-DRV-4830, -4845, -6575

These SureStep™ standard microstepping drives use pulse input signals, and are configured with DIP switches on the drive. These are fully enclosed drives, not open frame. To use these drives in a step motor control system, you will need the following:

- A 24–48 VDC power supply for the STP-DRV-4830/4845 or a 24–75 VDC power supply for the STP-DRV-6575. SureStep STP-PWR-x linear power supplies or PSBx Rhino regulated power supplies from AutomationDirect are good choices. If you decide not to use one of these recommended power supplies, then please read the section entitled “Choosing a Power Supply” in Chapter 8, “SureStep System Power Supplies.”
- A source of step pulses. Signal may be sinking (NPN), sourcing (PNP), or differential.
- The step inputs can be CW/CCW or Step & Direction. CW and CCW are viewed from the end opposite the drive end of the motor (looking out of the shaft).
- A compatible step motor, such as an AutomationDirect SureStep STP-MTRx. (Motor extension cables STP-EXTx are also available.)
- A small flat blade screwdriver for tightening the connectors.

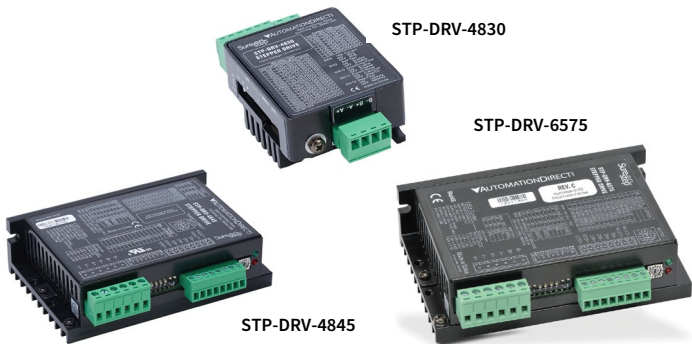

Refer to the “SureStep STP-DRV-4830/4845/6575 Microstepping Drive” chapter of this user manual for complete details on the installation, configuration, and wiring of this drive.

Standard Microstepping Drives (continued)

STP-DRV-4035

The SureStep™ STP-DRV-4035 standard microstepping drive uses pulse input signals, and is configured with DIP switches on the drive. To use this drive in a step motor control system, you will need the following:

- 12-42 volt DC power supply for the motor drive. The SureStep STP-PWR-3204 linear power supply from AutomationDirect is the best choice. If you decide not to use the STP-PWR-3204, please read the section entitled “Choosing a Power Supply” in Chapter 7, “SureStep System Power Supplies.”
- A source of step pulses. Signal may be sinking (NPN), sourcing (PNP), or differential.
- The step inputs can be CW/CCW, step and direction, or quadrature.
- A compatible step motor, such as an AutomationDirect SureStep STP-MTRx. (Motor extension cables STP-EXTx are also available.)
- A small flat blade or phillips screwdriver for tightening the connectors.

The STP-DRV-4035 standard microstepping drive is an open frame design.



STP-DRV-4035

Refer to the “SureStep STP-DRV-4035 Microstepping Drive” chapter of this user manual for complete details on the installation, configuration, and wiring of this drive.

High Bus Voltage Microstepping Drives

STP-DRVAC-24025

These SureStep™ high bus voltage drives use pulse input signals, and are configured with DIP switches on the drive. These are fully enclosed drives, not open frame. To use these drives in a step motor control system, you will need the following:

- A 90-240 VAC single phase power source (there is a 115/230V voltage selector switch on the drive).
- A source of step pulses. Signal may be sinking (NPN), sourcing (PNP), or differential.
- The step inputs can be CW/CCW or Step & Direction. CW and CCW are viewed from the end opposite the drive end of the motor (looking out of the shaft).
- A compatible step motor, such as an AutomationDirect SureStep STP-MTRAC-23x or STP-MTRAC-34x. The STP-MTRAC(H)-42x motors are not compatible with the STP-DRVAC-24025 (the motors can accept the high voltage, but the drive does not supply enough current).



NOTE: The drive always outputs a high bus voltage (~340V) that is compatible with our STP-MTRAC-x motors. This drive is not to be used with low-voltage STP-MTR-x motors. Always wire motors in series configuration with this drive. When supplied 115VAC, the drive has an internal voltage doubler, so the output voltage could be near 340V peak (whether supplied 115VAC or 230VAC).

Refer to “Chapter 5: SureStep STP-DRVAC-24025 Microstepping Drive” of this user manual for complete details on the installation, configuration, and wiring of this drive.



STP-DRVAC-24025

Advanced Microstepping Drive

The SureStep™ advanced microstepping drives (STP-DRV-4850 & -80100) are capable of accepting several different forms of input signals for control: pulse, analog, serial communication, or internal indexing. These drives are configured by computer with software which is included with the drive. To use one of these drives in a step motor control system, you will need the following:

- A DC power supply for the motor drive. A compatible SureStep STP-PWR-xxxx linear power supply from AutomationDirect is the best choice.
- A source of input control signals, such as a PLC from AutomationDirect.
- A compatible step motor, such as an AutomationDirect SureStep STP-MTRx. (Motor extension cables STP-EXTx are also available.)
- A small flat blade screwdriver for tightening the connectors.

The SureStep advanced microstepping drives are enclosed with removable wiring terminal blocks.



STP-DRV-80100

Refer to the “SureStep™ Advanced Microstepping Drives” chapter of this user manual for complete details on the installation, configuration, and wiring of this drive.

Standard Integrated Motors/Drives

The SureStep™ STP-MTRD standard series integrated motors/drives (STP-MTRD-17 and -23) use pulse input signals, and are configured with DIP switches on the drive. To use this motor/drive in a step motor control system, you will need the following:

- 12-48 volt (for 17 series) or 12-70 volt (for 23 series) DC power supply for the motor/drive. The SureStep linear power supplies from AutomationDirect are the best choice. If you decide not to use a STP-PWR-xxxx, please read the section entitled “Choosing a Power Supply” in Chapter 7, “SureStep System Power Supplies.”
- A source of step pulses. Signal may be sinking (NPN), sourcing (PNP), or differential.
- The step inputs can be CW/CCW, step and direction, or quadrature.
- A small flat blade screwdriver (3/32”) for tightening the connectors.

The SureStep standard integrated motors/drives are enclosed with removable wiring terminal blocks. Models with external encoders (for position feedback to a PLC, motion controller, etc.) are available.



Refer to Chapter 5: “SureStep Integrated Motors/Drives” for complete details on the installation, configuration, and wiring of this motor/drive.

Advanced Integrated Motors/Drives

The SureStep™ STP-MTRD advanced series integrated motors/drives (STP-MTRD-17R, -23R, and -24R) are capable of accepting several different forms of input signals for control: pulse, analog, serial communication, or internal indexing (via serial communications). These motors/drives are configured with software which is included with the drive. To use one of these motors/drives in a step motor control system, you will need the following:

- A DC power supply for the motor drive (12-48 volt for 17 series, 12-70 volt for 23 and 24 series). A compatible SureStep STP-PWR-xxxx linear power supply from AutomationDirect is the best choice.
- A source of input control signals, such as a PLC from AutomationDirect.
- A small flat blade screwdriver for tightening the connectors.

The SureStep advanced integrated motors/drives are enclosed with removable wiring terminal blocks. Models with internal encoders (for position verification and stall prevention inside the motor/driver) are available.



Refer to Chapter 5: “SureStep Integrated Motors/Drives” for complete details on the installation, configuration, and wiring of this motor/driver.

Step Motor Introduction

AutomationDirect offers many different models of bipolar¹ step motors with mounting flanges in two different shaft configurations (single and dual-shaft), and in five different NEMA frame sizes (14, 17, 23, 34, and 42). There are a variety of motor types available: low torque (STP-MTRL), high torque (STP-MTR, STP-MTRAC), and higher torque (STP-MTRH, STP-MTRACH). Models that have a “D”, “E”, or “W” variant represent a dual shaft option (D), an encoder pre-mounted to the motor (E), or IP65 washdown rated (W) respectively. The “D” variants are encoder ready with pre-drilled and tapped holes on the rear face for encoder mounting. All low-voltage motors have a 12-inch connectorized cable, and optional matching 6, 10, or 20-foot connectorized extension cables (STP-EXTx) are also available. The IP65 motors (W models) have IP65 rated connectors. The high bus voltage NEMA 23 and 34 MTRAC motors have integrated 8-lead 10-foot cables. The NEMA42 motors have 12-inch connectorized cables that accept 8-lead extension cables in 6, 10, and 20 ft lengths (STP-EXT42x). Refer to Chapter 6: “SureStep™ Stepping Motors” in this user manual for complete details on the specifications, installation, mounting, dimensions, and wiring of the SureStep step motors.

¹: All SureStep motors are bipolar wound, but STP-MTRAC(H)-42x motors can be wired for bipolar series, bipolar parallel, or unipolar use. Automation Direct does not have a drive that can run a unipolar wired motor.

STP-MTRx
NEMA 14, 17, 23, 34, 42
Frame Sizes



STP-MTRx Motors available in Single-shaft, Dual-shaft (encoder ready), Encoder Mounted, and IP65 (washdown) Models. STP-MTRAC-x Motors available in Single-shaft or Dual-shaft (encoder ready) models.



STP-MTRAC-42x

Stepping System Power Supply Introduction

The SureStep stepping system power supplies are designed to work with SureStep microstepping drives and motors. The different power supply models can provide unregulated DC power at the applicable voltage and current levels for various SureStep drives and motors. The power supplies also provide a regulated 5VDC, 500 mA logic supply output for indexer and PLC logic outputs to control the SureStep drives. Automation Direct switching power supplies PSB12-xxxS, PSB24-xxxS, and PSB48-xxxS are good non-linear supplies. A regen clamp may be needed if using these supplies. For more information on using the power supplies please see Chapter 8: "SureStep System Power Supplies".

Linear Power Supplies

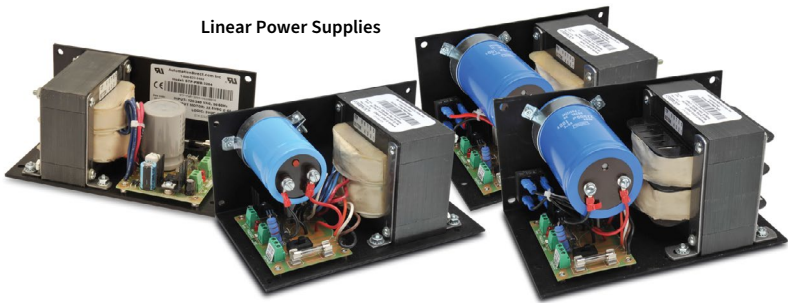

Switching Power Supplies

The stepping system power supplies can supply power for multiple SureStep STP-DRV-xxxx microstepping motor drives, depending on step motor size and application requirements.

Refer to the Power Supply chapter of this user manual for complete details on the specifications, installation, mounting, dimensions, and wiring of the SureStep stepping system power supplies.

Further information about braking accessories and regeneration clamping can be found in Appendix A: "SureStep Accessories" and the STP-DRVA-RC-050 or STP-DRVA-RC-50A REGENERATION CLAMP datasheet.

Selecting the Stepping System

Refer to Appendix C: Selecting the SureStep™ Stepping System for detailed information on how to calculate requirements for various applications using stepping motors for motion control.

Use with AutomationDirect PLCs

Refer to Appendix B: Using SureStep™ with AutomationDirect PLCs for detailed information on wiring the SureStep Stepping System components to AutomationDirect PLCs and high-speed counter modules.

The following is a summary of the AutomationDirect PLCs and module part numbers that are suitable to work with the SureStep Stepping Systems:

High-Speed Pulse Output Control (Standard Drives)

Any AutomationDirect PLC with high speed pulse output can control the SureStep Standard and Advanced stepper drives and integrated motor/drives. Certain high-speed PLC outputs are 24VDC and may require dropping resistors to work with 5VDC stepper inputs. See Appendix B in this manual and the appropriate PLC User Manual for more detailed information.

AutomationDirect PLCs that can use pulse train outputs with SureStep drives:

BRX Series (all models with DC outputs on the CPU module)

Productivity Series (all P2 and P3 CPUs - with the P2-HSO/P3-HSO modules)

Do-More Series (all models that can use the H2-CTRIO2)

DirectLogic Series

- All CPU models that can use the H2-CTRIO2 (and other CTRIO models)
- Models with built-in high speed outputs (DL05, DL06)

Serial Communication Control (Advanced Drives)

AutomationDirect PLCs with an RS-232 port can control an Advanced stepper drive (STP-DRV-4850, STP-DRV-80100) with serial communication (one drive per PLC communication port). A PLC with an RS-485 port can control multiple Advanced integrated stepper motor/drives.

The **Click Series**, **BRX Series**, **Productivity Series**, and **Do-More Series** of PLCs allow for simple ASCII control of the Advanced drives and motor/drives. Of the DirectLogic Series of PLCs, we recommend only using the DL06 and D2-260 CPUs due to their advanced ASCII instruction set which includes PRINTV and VPRINT commands.

See Appendix B and the appropriate PLC User Manual for more detailed information.

**BLANK
PAGE**

SURESTEP™
STP-DRV-4830,
-4845, -6575
STANDARD DC
MICROSTEPPING DRIVES



CHAPTER
2

In This Chapter...

Features	2-2
Specifications	2-3
Typical Wiring Diagram	2-5
Wiring Connections and Configuration Switches	2-5
STP-DRV-4830	2-5
STP-DRV-4845 and STP-DRV-6575	2-6
Connecting the Motor	2-7
Connecting the Power Supply	2-8
SureStep™ Drive Digital Inputs and Outputs	2-9
Connecting the Input Signals: STEP and DIR	2-9
Connecting the Input Signals – EN Input	2-10
Connecting the Fault Output	2-11
Drive Configuration	2-12
Drive Configurations Settings	2-12
DIP Switch Settings	2-13
Alarm Codes	2-16
Mounting the Drive	2-19
Drive Heating	2-19
Dimensions and Mounting Slot Locations	2-19
STP-DRV-4830	2-19
STP-DRV-4845 and STP-DRV-6575	2-20

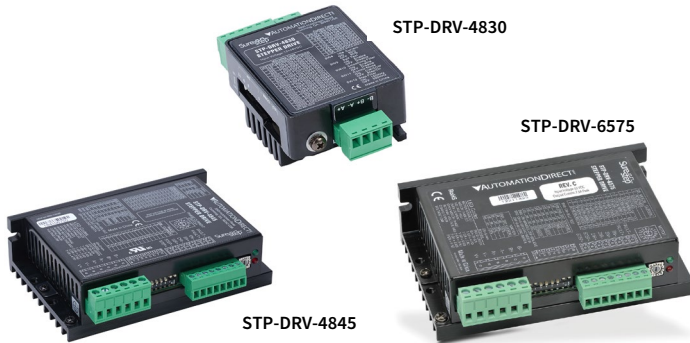

Features

- Low cost, digital step motor driver in compact package
- Operates from Step & Direction signals, or Step CW & Step CCW. CW and CCW rotation are viewed from the end opposite the drive end of the motor (looking out of the shaft)
- Enable input & Fault output (STP-DRV-4830 does not have a fault output)
- Optically isolated I/O
- Digital filters prevent position error from electrical noise on command signals; selectable: 150 kHz or 2MHz (-4845 and -6575 models), 150kHz or 500kHz (-4830 model)
- Rotary switch for selecting several SureStep motors or phase current settings
- Electronic damping and anti-resonance (-4845 and -6575 only)
- Automatic idle current reduction to reduce heat when motor is not moving; switch selectable: 50% or 90% of running current
- Switch-selectable step resolution: 200 (full-step); 400 (half-step); up to 20,000 (for -4845 and -6575) or up to 25600 (for the -4830) steps per revolution
- Switch selectable step input signal smoothing (microstep emulation) provides smoother, more reliable motion in full and half-step modes for the -4845 and -6575, and all step resolutions for the -4830
- Automatic self test (switch selectable)
- Drives operate from 12 or 24 to 48 or 72 VDC power supplies
- Running current ranges from 0.35 to 7.5A depending on drive

Specifications

SureStep™ Microstepping Drive Specifications				
Part Number	STP-DRV-4830		STP-DRV-4845	STP-DRV-6575
Input Power	12–48 VDC (53VDC max) (external power supply required; fuse at 3A fast-acting)		24–48 VDC (60VDC max) (external power supply required; fuse at 4A fast-acting)	24–75 VDC (85VDC max) (external power supply required; fuse at 7A fast-acting)
Output Current	0.35–3.0 A/phase (peak of sine)		0.8–4.5 A/phase (peak of sine)	1.0–7.5 A/phase (peak of sine)
Current Controller	Dual H-bridge digital MOSFET, 4-quadrant PWM at 16kHz		Dual H-bridge digital MOSFET, 4-quadrant PWM at 20kHz	
Input Signals	Step Function	Step or Step CW pulse		
	Step Electrical Specs	5–24 VDC nominal (range: 4–30 VDC); (5mA @ 4V; 15 mA @ 30V); Optically isolated, differential.		
		Maximum pulse frequency = 150 kHz or 500 kHz (user selectable). Minimum pulse width: 3 usec at 150 kHz setting SW12, 1 usec at 500 kHz setting SW12	Maximum pulse frequency = 150 kHz or 2MHz (user selectable). Minimum pulse width: 3 usec at 150 kHz setting jumper 4 1 usec at 2 MHz setting jumper 4	
	DIR Function	Direction or Step CCW pulse		
	DIR Electrical Specs	5–24 VDC nominal (range: 4–30 VDC); (5mA @ 4V; 15 mA @ 30V); Optically isolated, differential.		
		Max pulse frequency: 500 kHz Minimum pulse width: 3 usec at 150 kHz setting SW12, 1 usec at 500 kHz setting SW12	Maximum pulse frequency = 150 kHz or 2MHz (user selectable). Minimum pulse width: 3 usec at 150 kHz setting jumper 4 1 usec at 2 MHz setting jumper 4	
	EN Function	Disable motor when closed		
EN Electrical Specs	5–24 VDC nominal (range: 4–30 VDC); (5mA @ 4V; 15 mA @ 30V); Optically isolated, differential. Max pulse frequency: 10 kHz Minimum pulse width: 500 usec			
Output Signal	Fault	n/a	30 VDC / 80mA max, optically isolated photodarlington, sinking or sourcing. Function = closes on drive fault.	
Rotary Switch Selectable Function		n/a	Select motor based on part number, or by motor current.	

Specifications, continued

SureStep™ Microstepping Drive Specifications				
Part Number	STP-DRV-4830	STP-DRV-4845	STP-DRV-6575	
Jumper and DIP Switch Selectable Functions	Step Pulse Type	Step and Direction: Step signal = step/pulse; Direction signal = direction. Step CW & CCW: Step signal = CW step; Direction signal = CCW step (Internal jumper for -4845 and -6575; DIP switch for -4830)		
	Step Pulse Noise Filter	150kHz or 500kHz (switch to 500kHz if pulsing faster than 150kHz (DIP switch))	150 kHz or 2MHz (switch to 2MHz if pulsing faster than 150kHz)(internal jumper)	
	Current Reduction (DIP switch)	n/a	Reduce power consumption and heat generation by limiting motor running current to 100%, 90%, or 80%, (70% possible for STP-DRV-4845 only and 120% possible for the -6575 only) of maximum. Current should be increased to the maximum current reduction setting if microstepping. (Torque is reduced/increased by the same %.)	
	Idle Current Reduction (DIP switch)	Reduce power consumption and heat generation by limiting motor idle current to 90% or 50% of running current. (Holding torque is reduced by the same %.)		
	Load Inertia (DIP switch)	n/a	Anti-resonance and damping feature improves motor performance. Set motor and load inertia range to 0-4x or 5-10x.	
	Step Resolution (DIP switch)	200, 400, 800, 1000, 1600, 2000, 3200, 4000, 5000, 6000, 6400, 8000, 10000, 12800, 20000, 25600.	200, 200 smooth, 400, 400 smooth, 2000, 5000, 12800, 20000	
	Self Test (DIP switch)	Automatically rotate the motor back and forth two turns in each direction in order to confirm that the motor is operational.		
Smoothing Filter (DIP switch)	Softens the effect of immediate changes in velocity and direction, making the motion of the motor less jerky. Can cause a small delay in following the control signal.		n/a	
Drive Cooling Method	Natural convection (mount drive to metal surface)			
Mounting	Use (2) #6 screws to mount to metal surface			
Removable Connectors	DEGSON 15EDGK-5.08-02P-14-00AH 2-pin power connector DEGSON 15EDGK-3.1.04P-14-00A(H) 4-pin motor connector DEGSON 15EDGK-3.5-06P-14-00A(H) 6-pin I/O connector Part number STP-CON-5 contains replacements		Motor & Power Supply: Screw term blocks Phoenix Contact 1757051 (30-12AWG) Signals: Screw terminal blocks Phoenix Contact 1803633 (30-14 AWG) AutomationDirect part number STP-CON-1 contains these replacement connectors.	
Weight	3.0 oz [85.9g]		10.8 oz [306g]	
Operating Temperature	0 to 85 °C [32 to 185 °F] – (Interior of electronics section)			
Ambient Temperature	0 to 40 °C [32 to 104 °F]		0 to 50 °C [32 to 122 °F]	
Humidity	Maximum 90% non-condensing			
Agency Approvals	CE		CE, cUR _{US}	

Typical Wiring Diagram

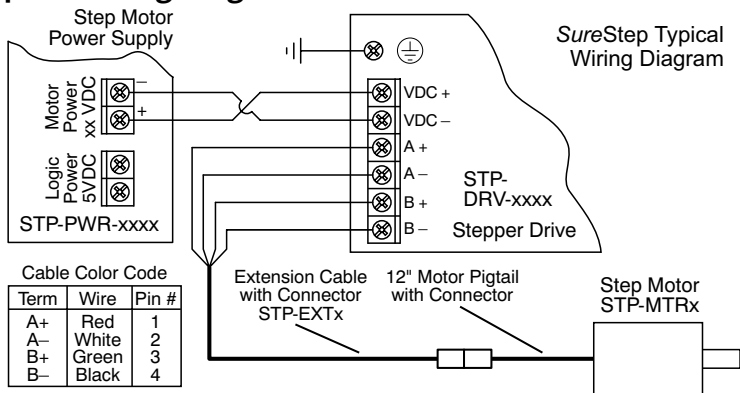

Wiring Connections and Configuration Switches

STP-DRV-4830

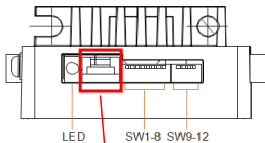
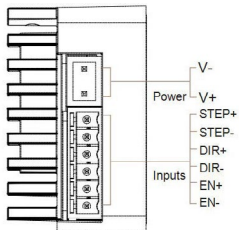

Factory use
comm port

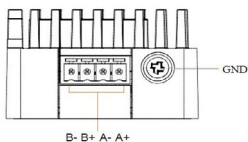

Terminal block part #s (shown) are Phoenix Contact (www.phoenixcontact.com)
All three terminal blocks are included in STP-CON-5 for replacement connectors

External wiring is connected using three separate pluggable screw terminal connectors. The power connections are on the 2-position connector, the motor connection is on the 4-position connector, and the digital inputs are on the 6-position connector.

STP-DRV-4845 and STP-DRV-6575

Terminals, Switches, Indicators

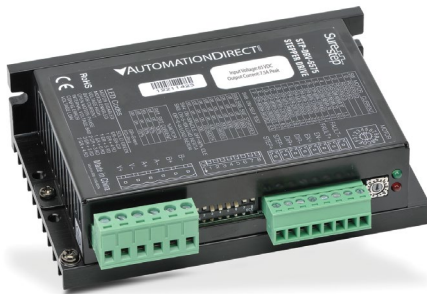
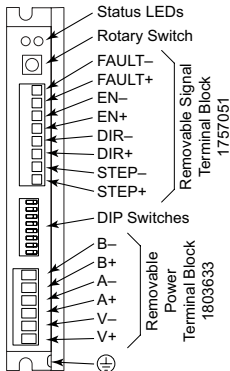

Terminal block part #s (shown) are
Phoenix Contact (www.phoenixcontact.com)
Both terminal blocks are included in STP-CON-1
for replacement connectors

External wiring is connected using two separate pluggable screw terminal connectors. The power connections share a six-position connector, and the digital inputs and output share an eight-position connector.

Connecting the Motor



Warning: When connecting a step motor to a SureStep™ microstepping drive, be sure that the motor power supply is switched off. When using a motor not supplied by AutomationDirect, secure any unused motor leads so that they can't short out to anything. Never disconnect the motor while the drive is powered up. Never connect motor leads to ground or to a power supply. (See the Typical Wiring Diagram shown in this chapter for the step motor lead color code of AutomationDirect supplied motors.)



CW and CCW are viewed from the end opposite the drive end of the motor (looking out of the shaft).

Four Lead Motors

Four lead motors can only be connected one way, as shown below.

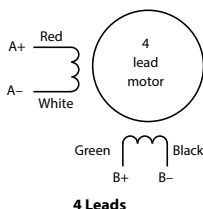

All AutomationDirect SureStep™ motors are four lead bipolar step motors except STP-MTRAC-x motors.

Six Lead Motors

Six lead motors can be connected in series or center tap. Motors produce more torque at low speeds in series configuration, but cannot run as fast as in the center tap configuration. In series operation, the motor should be operated at 30% less than rated current to prevent overheating.

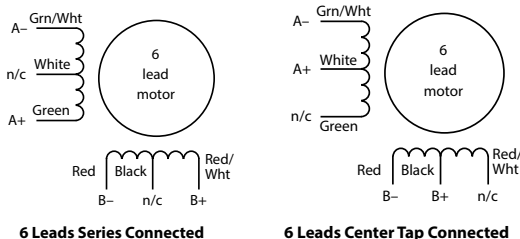

Step motor wire lead colors vary from one manufacturer to another.

Eight Lead Motors

Eight lead motors can also be connected in two ways: series or parallel. Series operation gives you more torque at low speeds, but less torque at high speeds. When using series connection, the motor should be operated at 30% less than the rated current to prevent over heating. Parallel operation allows greater torque at high speeds. When using parallel connection, the current can be increased by 40% above rated current. Care should be taken in either case to assure that the motor does not overheat.

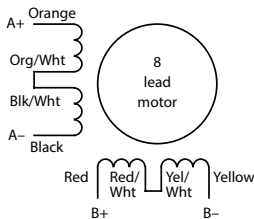

8 Leads Series Connected

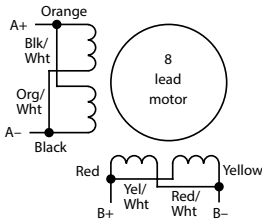

8 Leads Parallel Connected



Step motor wire lead colors vary from one manufacturer to another. The example above only pertains to STP-MTRAC-34075(x) and 34115(x) SureStep Motors. For NEMA 42 wire colors, see "Connecting a STP-MTRAC(H)-42 Motor" in Chapter 7.

Connecting the Power Supply

An STP-PWR-xxxx power supply from AutomationDirect is the best choice to power the step motor drive. If you need information about choosing a different power supply, refer to the section entitled "Choosing a Power Supply" in Chapter 7 of this manual.

If your power supply does not have a fuse on the output or some kind of short circuit current limiting feature, you need a fuse between the drive and the power supply. Install the fuse on the + power supply lead.

- Connect the green ground screw to earth ground
- Use 18 or 20 AWG wire.

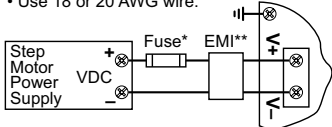

- * External fuse not required when using an STP-PWR-xxxx P/S; fuse is internal.
- ** CE use requires an EMI line filter.

Further information about EMI line filters, braking accessories, and regeneration clamping can be found in Appendix A: "SureStep Accessories" and the STP-DRVA-RC-050A or STP-DRVA-RC-050 REGENERATION CLAMP datasheet.



Do NOT use STP-PWR-70xx power supplies with an STP-DRV-6575 drive, because those power supplies can exceed the voltage limit of this drive if supplied with a higher than normal 120VAC supply. STP-DRV-6575 overvoltage fault is 85V.

Connecting the I/O

SureStep™ Drive Digital Inputs and Outputs

The SureStep STP-DRV-4830, -4845, and -6575 drives include two high-speed 5–24 VDC digital inputs (STEP & DIR), one standard-speed 5–24 VDC digital input (EN), and one 30 VDC digital output (Fault). The -4830 does not have an output.

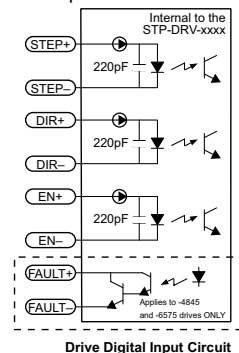

The digital inputs are optically isolated to reduce electrical noise problems. There is no electrical connection between the control and power circuits within the drive, and input signal communication between the two circuits is achieved by infrared light. Externally, the drive's motor power and control circuits should be supplied from separate sources, such as from a step motor power supply with separate power and logic outputs.

For bidirectional rotation, supply a source of step pulses to the drive at the STEP+ and STEP- terminals, and a directional signal at the DIR+ and DIR- terminals.

The ENABLE input allows the logic to turn off the current to the step motor by providing a signal to the EN+ and EN- terminals. The EN+ and EN- terminal can be left unconnected if the enable function is not required.

All logic inputs can be controlled by a DC output signal that is either sinking (NPN), sourcing (PNP), or differential.

Connecting the Input Signals: STEP and DIR

Connecting Inputs to an Indexer with Sinking Outputs

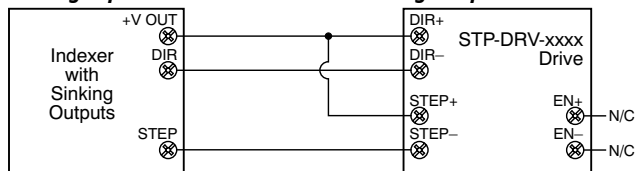

Connecting Inputs to an Indexer with Sourcing Outputs

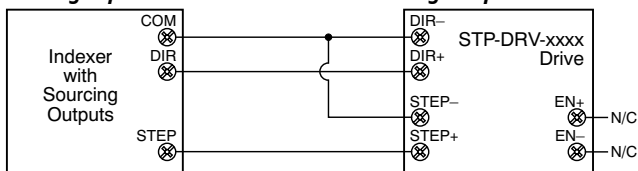

Connecting the Input Signals – STEP and DIR (continued)**Connecting Inputs to an Indexer with Differential Line Driver Outputs****Connecting the Input Signals – EN Input**

The ENABLE input allows the user to turn off the current to the motor by providing a 5–24 VDC positive voltage between EN+ and EN-. The logic circuitry continues to operate, so the drive “remembers” the step position even when the amplifiers are disabled. However, the motor may move slightly when the current is removed depending on the exact motor and load characteristics.

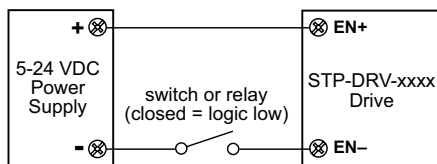
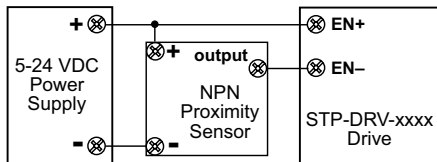

Warning: 24VDC is the maximum voltage that can be applied directly to the standard speed EN input. If using a higher voltage power source, install resistors to reduce the voltage at the input. Do NOT apply an AC voltage to an input terminal.

Connecting ENABLE Input to Relay or Switch**Connecting ENABLE Input to NPN Proximity Sensor**

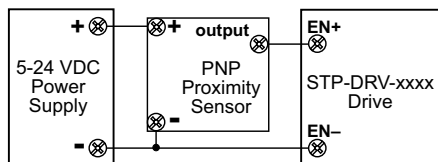
Connecting ENABLE Input to PNP Proximity Sensor

Leave the ENABLE input unconnected if you do not need to disable the amplifiers.

Connecting the Fault Output

The SureStep STP-DRV-4845 and -6575 drives have one digital output that has separate positive (+) and negative (-) terminals, and can be used to sink or source current. There is no digital output on the STP-DRV-4830.

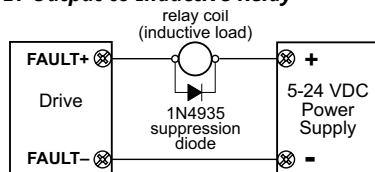
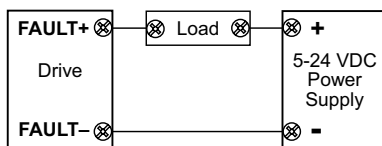
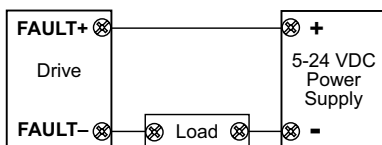
Connecting FAULT Output to Inductive Relay**Connecting FAULT Output as Sinking Output****Connecting FAULT Output as Sourcing Output**

Do not connect more than 30 VDC. Current must not exceed 80 mA.

Drive Configuration

You need to configure your drive for your particular application before using the drive for the first time. The SureStep STP-DRV-4830, -4845, and -6575 microstepping drives offer several features and configuration settings, including:

Drive Configurations Settings

Drive Configuration Settings				
Feature	Description	Configuration Method		
		STP-DRV-4830	STP-DRV-4845	STP-DRV-6575
Motor Phase Current	Select motor based on part number, or set by motor current.	Set current via DIP switch 1,2,3	Set current via rotary switch	Select motor via rotary switch
Mode of Operation (Step Pulse Type)	Step and Direction (default): Step signal = step/pulse; Direction signal = direction. Step CW & CCW: Step signal = CW step; Direction signal = CCW step.	DIP switch 11	Jumper S3 (see details later in this section)	
Step Pulse Noise Filter	Select 150 kHz or 2MHz for -4845 and -6575 or Select 150 kHz or 500 kHz for -4830	DIP switch 12	Jumper S4 (see details later in this section)	
Current Reduction	Reduce power consumption and heat generation by limiting motor running current to 100%, 90%, or 80% of maximum. Current should be increased to 120% if microstepping. (Torque is reduced/increased by the same %.)	N/A	DIP switch 1,2	
Idle Current Reduction	Reduce power consumption and heat generation by limiting motor idle current to 90% or 50% of running current. (Holding torque is reduced by the same %.)	DIP switch 4		
Load Inertia	Anti-resonance and damping feature improve motor performance. Set motor and load inertia range to 0-4x or 5-10x.	N/A	DIP switch 3	
Step Resolution	For smoother motion and more precise speed, set the pulse per revolution value as needed.	DIP switch 5,6,7,8	DIP switch 5,6,7	
Self Test	Automatically rotates the motor back and forth 1/2 a revolution in each direction in order to confirm that the motor is operational.	DIP switch 9	DIP switch 8	
Step Smoothing Filter	Softens the effect of immediate changes in velocity and direction, making the motion of the motor less jerky. Can cause a small delay in following the control signal.	DIP switch 10	N/A (step smoothing is available using the "200 smooth" or "400 smooth" setting for DIP switch 5,6,7)	

DIP Switch Settings

STP-DRV-4830

(Factory default = switches 1-4 ON, switches 5-12 OFF)

Current Setting

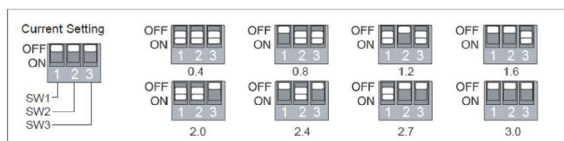

Step Resolution (steps/rev)

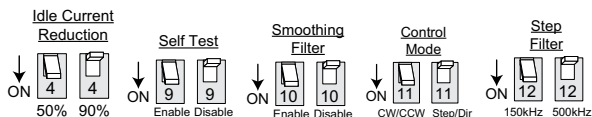
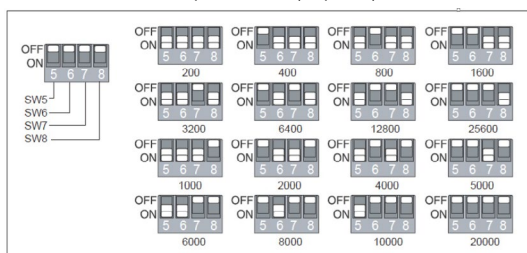

STP-DRV-4845 and STP-DRV-6575

(Factory default = all switches OFF)

Step Resolution (steps/rev)

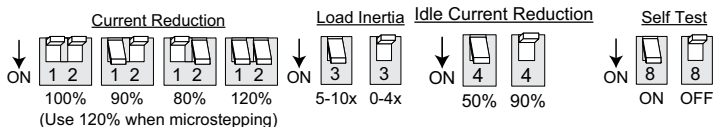

Jumper Settings for STP-DRV-4845 and STP-DRV-6575

Jumpers S3 and S4 are located on the internal circuit board, and they can be accessed by removing the drive's front cover.

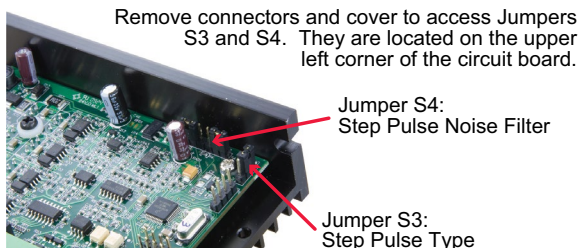

Remove connectors and cover to access Jumpers S3 and S4. They are located on the upper left corner of the circuit board.

Jumper S3 – Step Pulse Type

- Jumper in “1-2” position – Step & Direction (factory default)
- Jumper in “1-3” position – Step CW / Step CCW

Jumper S4 – Step Pulse Noise Filter

- Jumper in “1-2” position – 2MHz (factory default)
- Jumper in “1-3” position – 150 kHz

Rotary Switch Settings – Motor/Current Settings



















STP-DRV-4845 Motor Selection Table (A/Phase)(Peak of Sine A)					
Rotary Switch Position	SW1 & SW2 @100%	SW1 & SW2 @90%	SW1 & SW2 @80%	SW1 & SW2 @70%	
	0	1.1	1.0	0.9	0.8
	1	1.3	1.2	1.0	0.9
	2	1.5	1.4	1.2	1.1
	3	1.7	1.5	1.4	1.2
	4	2.0	1.8	1.6	1.4
	5	2.2	2.0	1.8	1.5
	6	2.4	2.2	1.9	1.7
	7	2.6	2.3	2.1	1.8
	8	2.8	2.5	2.2	2.0
	9	3.1	2.8	2.5	2.2
	A	3.4	3.1	2.7	2.4
	B	3.6	3.2	2.9	2.5
	C	3.8	3.4	3.0	2.7
	D	4.0	3.6	3.2	2.8
	E	4.3	3.9	3.4	3.0
F	4.5	4.1	3.6	3.2	

STP-DRV-6575 Motor Selection Table									
Motor STP-MTR -xxx(X)	Motor Data					Drive Configuration Data			Rotary Switch Position
	Motor Current (A _{rms} /phase)	Holding Torque (oz·in)	Rotor Inertia (oz·in ²)	Inductance (mH)	Resistance (Ω)	Torque (mN·m)	Inertia (g·cm ²)	Drive Current (peak sine A)	
n/a	reserved								0-2
n/a	1.3	custom NEMA 17							3
n/a	4.0	custom NEMA 23							4
n/a	4.0	custom NEMA 34							5
-17040	1.7	61	0.28	3.03	1.60	434	51	2.04	6
-17048	2.0	83	0.37	2.65	1.40	586	82	2.40	7
-17060	2.0	125	0.56	3.30	2.00	883	37	2.40	8
-23055	2.8	166	1.46	2.36	0.08	1172	271	3.36	9
-23079	2.8	276	2.60	3.82	1.10	1949	475	3.36	A
-34066	2.8	434	7.66	7.70	1.11	3065	1402	3.36	B
H-23079	5.6	287	2.60	1.18	0.40	2025	371	6.72	C
H-34066	6.3	428	7.66	1.52	0.25	3021	1402	7.56	D
H-34097	6.3	803	14.80	2.07	0.03	5668	2708	7.56	E
H-34127	6.3	1292	21.90	4.14	0.49	9123	4008	7.56	F



Alarm Codes

In the event of a drive fault or alarm, the green LED will flash one or two times, followed by a series of red flashes. The pattern repeats until the alarm is cleared.

STP-DRV-xxxx Alarm Codes		
Alarm Code	LED Sequence	Alarm Description
SG	 Solid green	No alarm, motor disabled
FG	 Fast green	Factory use
01	 Flashing green	No alarm, motor enabled
10	 Flashing red	Configuration or memory error ¹
11	 1 red, 1 green	Motor stall (optional encoder only) ⁴
12	 1 red, 2 green	Move attempted while drive disabled
21	 2 red, 1 green	CCW limit
22	 2 red, 2 green	CW limit
31	 3 red, 1 green	Drive overheating
32	 3 red, 2 green	Internal voltage out of range ²
33	 3 red, 3 green	Factory use
41	 4 red, 1 green	Power supply overvoltage ²
42	 4 red, 2 green	Power supply undervoltage
43	 4 red, 3 green	Flash memory backup error
51	 5 red, 1 green	Over current / short circuit ^{2, 3}
61	 6 red, 1 green	Open motor winding ²
62	 6 red, 2 green	Bad encoder signal (optional encoder only) ⁴
71	 7 red, 1 green	Serial communication error ⁵
72	 7 red, 2 green	Flash memory error

¹ - Does not disable the motor.

The alarm will clear about 30 seconds after the fault is corrected.

² - Disables the motor. Cannot be cleared until power is cycled.

³ - The over-current/short-circuit alarm typically indicates that an electrical fault exists somewhere in the system external to the drive. This alarm does not serve as motor overload protection.

⁴ - This alarm only occurs on STP-MTRD advanced integrated motor/drives

⁵ - This alarm only occurs on drives with serial communication.

Alarm Code Definitions

Alarm Code	Error	Description	Corrective Action
5G	No alarm, motor disabled	No faults active, Circuit is closed between EN+ and EN-.	N/A
01	No alarm, motor enabled	No faults active, Circuit is open between EN+ and EN-.	N/A
10	Configuration or memory error	Memory error detected when trying to load config from flash on powerup.	Restart device. No fix if restart doesn't work. Return to manufacturer for correction.
11	Motor stall (optional encoder only)	Motor torque demand exceeded capability and the motor skipped steps. This is configured in SureMotion Pro.	Increase torque utilization if it's not already maxed out, otherwise decrease the torque demand by modifying the move profile, or put in a larger motor.
12	Move attempted while drive disabled	Drive is disabled and move attempted.	Reset alarm, enable motor, and move again.
21	CCW limit	CCW limit is reached. The digital input that has been assigned CCW limit has been activated.	Unblock the CCW sensor (open the circuit) or redefine the input with SureMotion Pro.
22	CW limit	CW limit is reached. The digital input that has been assigned CW limit has been activated.	Unblock the CCW sensor (open the circuit) or redefine the input with SureMotion Pro.
31	Drive overheating	The drive's internal temperature is too high.	If the drive is operating within its standard range (input voltage and output current are OK), more heat must be removed from the drive during operation. For Advanced drives (see "Mounting the Drive" on page 4-14), ensure the drive is mounted to a metal surface that can dissipate the drive's heat. For Integrated motor/drives, see "Mounting" on page 5-13. For both types of drives: If the mounting surface cannot pull enough heat away from the drive, forced airflow (from a fan) may be required to cool the drive.
32	Internal voltage out of range	Gate voltage, 5V rail, or 3V rail are out of spec.	Ensure adequate supply voltage (in very rare cases, low input voltages combined with fast accelerations can draw down the gate voltage) and try again. If persistent, RMA is required.

Alarm Code	Error	Description	Corrective Action
41	Power supply overvoltage	The DC voltage feeding the drive is above the allowable level.	<p>Decrease the input voltage.</p> <p>Linear power supplies do not output a fixed voltage: the lighter the output current, the higher the output voltage will float. If a linear supply's voltage floats above the drive's max voltage, you can install a small power resistor across the linear power supply's output to provide some load that will help pull down the floating voltage.</p> <p>Consider using a switching power supply such as the Rhino PSB power supply series.</p> <p>Overvoltage can also be fed back into a system by regeneration (when an overhauling load pushes energy back into the motor). In an application with regen problems, install an STP-DRVA-RC-050 regen clamp to help dissipate the extra energy. (The regen clamp will not help with the floating linear power supply that floats too high, but it will help with excess voltage generated from an overhauling load.)</p>
42	Power supply undervoltage	The DC voltage feeding the drive is below the allowable level.	Correct the power supply. If this error occurs during operation, the power supply is most likely undersized. A sudden high current demand can cause an undersized power supply to dip in output voltage.
43	Flash memory backup error	Memory error detected when trying to load config from flash on powerup.	Restart device. No fix if restart doesn't work. Return to manufacturer for correction.
51	Over current / short circuit	Motor leads shorted - only checked on powerup.	Check and fix motor wiring.
61	Open motor winding	Motor leads not connected - only checked on powerup.	Check and fix motor wiring.
62	Bad encoder signal (optional encoder only)	Noisy or otherwise incorrectly formatted encoder signal (lack of A or B, lack of differential signal).	Check encoder wiring, always use differential encoders (or use checkbox in SureMotion Pro to disable this error when using single ended).
71	Serial communication error	Catch-all error for something wrong with serial communications. See CE command in HCR for details.	If drive can communicate, CE can give a precise diagnosis. If not, refer to the Serial Communications part of the HCR for troubleshooting.
72	Flash memory error	Memory error detected when trying to load config from flash on powerup.	Restart device. No fix if restart doesn't work. Return to manufacturer for correction.

Mounting the Drive

You can mount your drive on the wide or the narrow side of the chassis using (2) #6 screws. Since the drive amplifiers generate heat, the drive should be securely fastened to a smooth, flat metal surface that will help conduct heat away from the chassis. If this is not possible, then forced airflow from a fan may be required to prevent the drive from overheating.

- Never use your drive in a space where there is no air flow or where the ambient temperature exceeds 50 °C (122 °F).
- When mounting multiple STP-DRV-xxxx drives near each other, maintain at least one half inch of space between drives.
- Never put the drive where it can get wet.
- Never allow metal or other conductive particles near the drive.

Drive Heating

For information on drive heating, please see Chapter 8: SureStep System Power Supplies.

Dimensions and Mounting Slot Locations

STP-DRV-4830

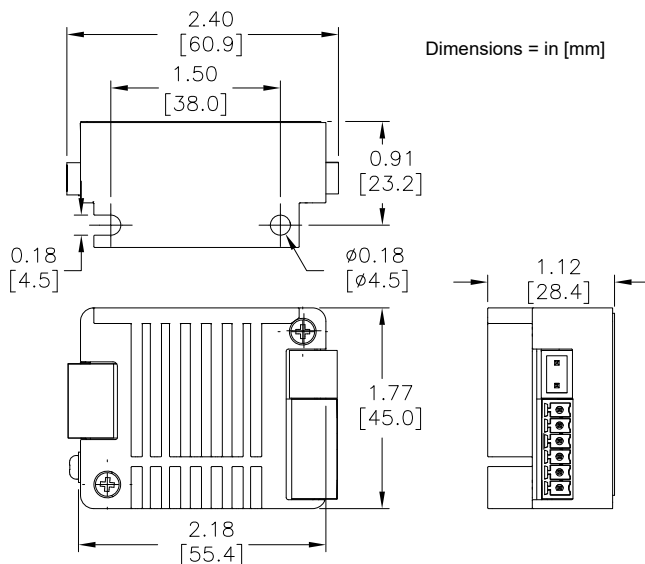

STP-DRV-4845 and STP-DRV-6575

Dimensions = in [mm]

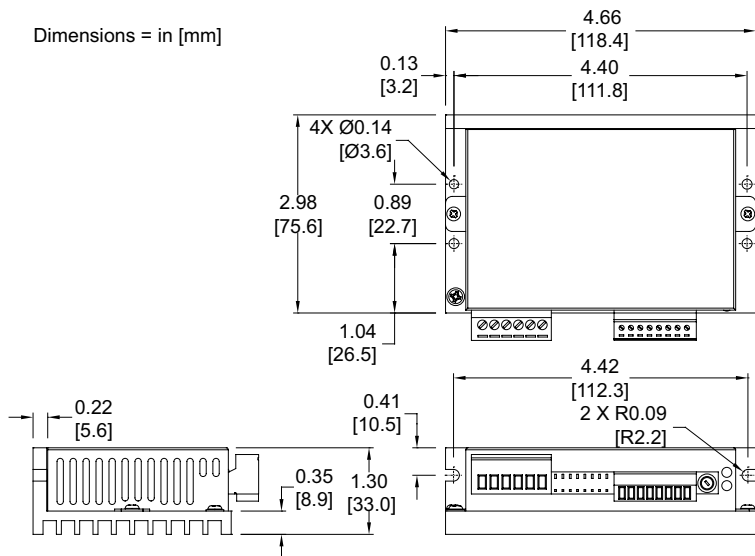

SURESTEP™
STP-DRV-4035
BASIC DC
MICROSTEPPING DRIVE



CHAPTER
3

In This Chapter...

Features	3-2
Specifications	3-3
Typical Wiring Diagram	3-4
Connection and Adjustment Locations	3-4
Connecting the Motor	3-5
Connecting the Power Supply	3-6
Connecting the Logic	3-7
Using Logic That is Not 5 volt TTL Level	3-9
The Enable Input	3-9
Setting Phase Current	3-10
Current Setting Formula	3-10
Current Setting Table	3-11
Microstepping	3-12
Idle Current Reduction	3-13
Self Test	3-13
Dimensions	3-15

Features

- Drives sizes 17 through 34 step motors
- Pulse width modulation, MOSFET 3 state switching amplifiers
- Phase current from 0.4 to 3.5 amps (switch selectable, 32 settings)
- Optically isolated step, direction and enable inputs
- Half, 1/5, 1/10, 1/50 step (switch selectable)
- Automatic 50% idle current reduction (can be switched off)

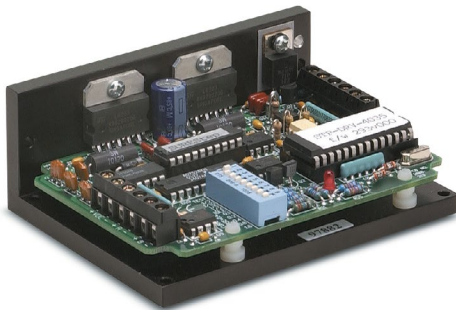

Specifications

SureStep™ Microstepping Drives Specifications		
Part Number		STP-DRV-4035
Input Power (with red Power On LED)		12-42 VDC (including ripple voltage)
Output Power		Output current selectable from 0.4 to 3.5 Amps/phase motor current (maximum output power is 140 W)
Current Controller		Dual H-bridge Bipolar Chopper (4-state 20 kHz PWM with MOSFET switches)
Input Signals	Input Signal Circuit	Opto-coupler input with 440 Ohm resistance (5 to 15 mA input current), Logic Low is input pulled to 0.8 VDC or less, Logic High is input 4VDC or higher (see page 3-9 for using input voltages higher than 5VDC)
	Pulse Signal	Motor steps on falling edge of pulse and minimum pulse width is 0.5 microseconds
	Direction Signal	Needs to change at least 2 microseconds before a step pulse is sent. CW and CCW are viewed from the end opposite the drive end of the motor (looking out of the shaft).
	Enable Signal	Logic 1 will disable current to the motor (current is enabled with no hook-up or logic 0)
DIP Switch Selectable Functions	Self Test	Off or On (uses half-step to rotate 1/2 revolution in each direction at 100 steps/second)
	Microstepping	400 (200x2), 1,000 (200x5), 2,000 (200x10), or 10,000 (200x50) steps/rev
	Idle Current Reduction	0% or 50% reduction (idle current setting is active if motor is at rest for 1 second or more)
	Phase Current Setting	0.4 to 3.5 Amps/phase with 32 selectable levels
Drive Cooling Method		Natural convection (mount drive to metal surface if possible)
Dimensions		3 x 4 x 1.5 inches [76.2 x 101.6 x 38.1 mm]
Mounting		Use #4 screws to mount on wide side (4 screws) or narrow side (2 screws)
Connectors		Screw terminal blocks with AWG 18 maximum wire size
Weight		9.3 oz. [264g]
Storage Temperature		-20-80 °C [-4-176 °F]
Chassis Operating Temperature		0-55 °C [32-131 °F] recommended; 70 °C [158 °F] maximum (use fan cooling if necessary); 90% non-condensing maximum humidity
Agency Approvals		CE



Note: The STP-DRV-4035 Microstepping Drive works with 4, 6, and 8 lead bipolar step motors. All AUTOMATIONDIRECT SureStep™ motors are four-lead bipolar step motors.

Typical Wiring Diagram

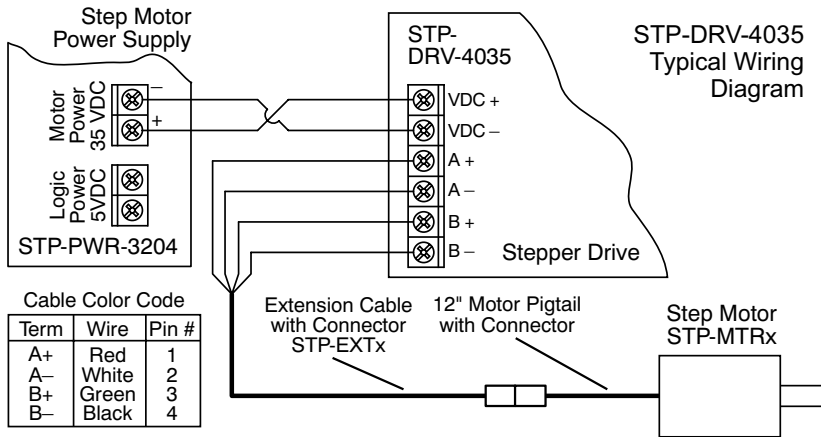

Connection and Adjustment Locations

The diagram below shows where to find the important connection and adjustment points.

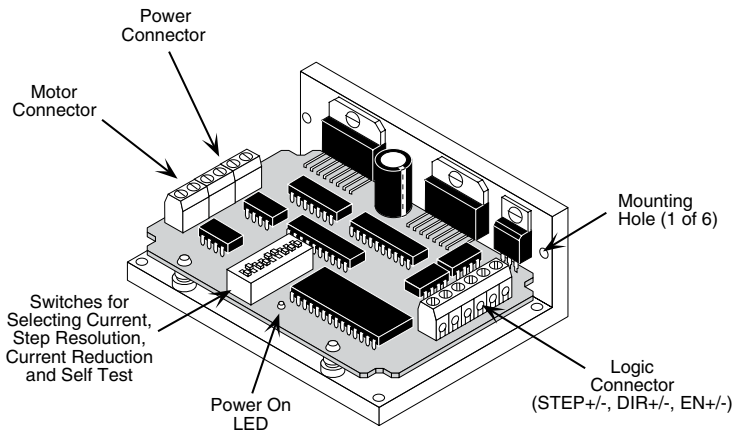

Connecting the Motor



WARNING: When connecting a step motor to the SureStep™ STP-DRV-4035 microstepping drive, be sure that the motor power supply is switched off. When using a motor not supplied by AUTOMATIONDIRECT, secure any unused motor leads so that they can't short out to anything. Never disconnect the motor while the drive is powered up. Never connect motor leads to ground or to a power supply. (See the Typical Wiring Diagram shown on page 2-4 of this chapter for the step motor lead color code of AUTOMATIONDIRECT supplied motors.)

You must now decide how to connect your stepping motor to the SureStep™ STP-DRV-4035 microstepping drive.

Four Lead Motors

Four lead motors can only be connected one way. Please follow the wiring diagram shown to the right.



Note: All AUTOMATIONDIRECT SureStep™ motors are four lead bipolar step motors.

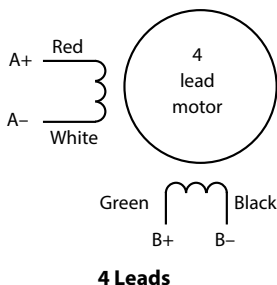

Six Lead Motors

Six lead motors can be connected in series or center tap. In series mode, motors produce more torque at low speeds, but cannot run as fast as in the center tap configuration. In series operation, the motor should be operated at 30% less than rated current to prevent overheating. Wiring diagrams for both connection methods are shown below. **NC** means not connected to anything.

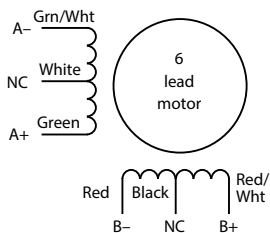

6 Leads Series Connected

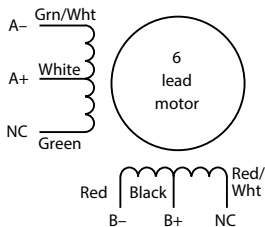

6 Leads Center Tap Connected



Note: Be aware that step motor wire lead colors vary from one manufacturer to another.

Eight Lead Motors

Eight lead motors can also be connected in two ways: series or parallel. Series operation gives you more torque at low speeds and less torque at high speeds. When using series connection, the motor should be operated at 30% less than the rated current to prevent over heating. Parallel operation allows a greater torque at high speed. When using parallel connection, the current can be increased by 30% above rated current. Care should be taken in either case to assure the motor is not being overheated. The wiring diagrams for eight lead motors are shown below.

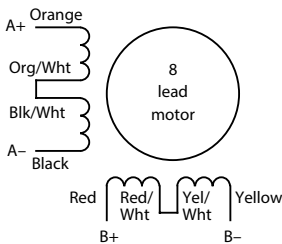

8 Leads Series Connected

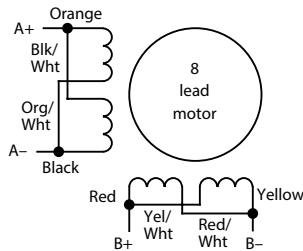

8 Leads Parallel Connected



Note: Be aware that step motor wire lead colors vary from one manufacturer to another. The example above only pertains to STP-MTRAC-34075(x) and 34115(x) SureStep Motors.

Connecting the Power Supply

The STP-PWR-3204 power supply from **AUTOMATIONDIRECT** is the best choice to power the step motor drive. If you need information about choosing a different power supply, please read the section titled “Choosing a Power Supply” in Chapter 7: “SureStep System Power Supplies”.

If your power supply does not have a fuse on the output or some kind of short circuit current limiting feature you need to put a 4 amp fast acting fuse between the drive and power supply. Install the fuse on the + power supply lead.

Connect the motor power supply “+” terminal to the driver terminal labeled “+ VDC”. Connect power supply “-” to the drive terminal labeled “VDC-”. Use no smaller than 18 gauge wire. **Be careful not to reverse the wires.** Reverse connection will destroy your drive and void the warranty.

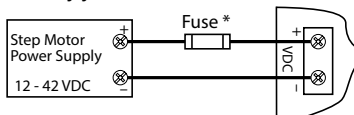

* External fuse not required when using an STP-PWR-3204 P/S; fuse is internal.



Do NOT use STP-PWR-48xx or -70xx power supplies with an STP-DRV-4035 drive, because those power supplies exceed the voltage limit of this drive.

Further information about braking accessories and regeneration clamping can be found in Appendix A and the STP-DRVA-RC-050 REGENERATION CLAMP datasheet.

Connecting the Logic

The SureStep drive contains optical isolation circuitry to prevent the electrical noise inherent in switching amplifiers from interfering with your circuits. Optical isolation is accomplished by powering the motor driver from a different supply source than your control circuits. There is no electrical connection between the two; signal communication is achieved by infrared light. When your circuit turns on or turns off, an infrared LED (built into the drive), signals a logic state to the phototransistors that are wired to the brains of the drive. A schematic diagram input circuit is shown to the right.

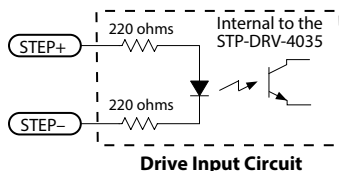

You will need to supply a source of step pulses to the drive at the STEP+ and STEP- terminals and a direction signal at the DIR+ and DIR- terminals, if bidirectional rotation is required. You will also need to determine if the **ENABLE** input terminals will be used in your application. Operation, voltage levels and wiring on the **ENABLE** terminals is the same as the **STEP** and **DIRECTION** terminals. The EN+ and EN- terminal can be left not connected if the enable function is not required.

All logic inputs can be controlled by a DC output signal that is either sinking (NPN), sourcing (PNP), or differential.

On the next couple of pages are examples for connecting various forms of outputs from both indexers and PLCs.

Connecting to an Indexer with Sinking Outputs

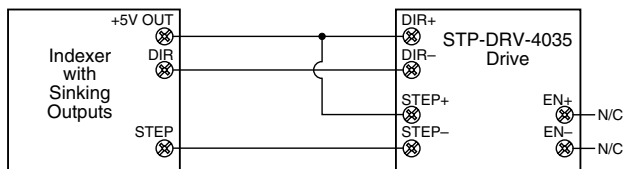

Connecting to an Indexer with Sourcing Outputs

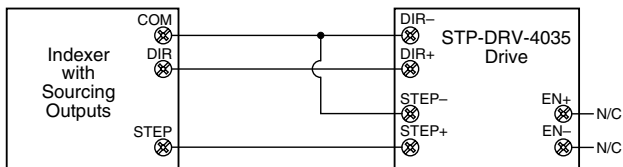

Connecting to an Indexer with Differential Outputs

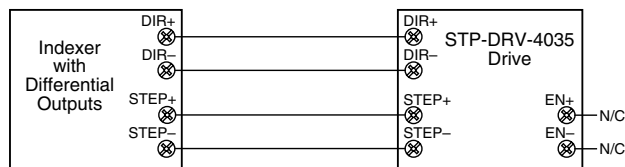

Note: Many high speed indexers have differential outputs.

Using Logic That is Not 5 volt TTL Level

Some step and direction signals, especially those of PLCs, don't use 5 volt logic. You can connect signal levels as high as 24 volts to the SureStep drive if you add external dropping resistors to the STEP, DIR and EN inputs, as shown below.

- For 12 volt logic, add 820 ohm, 1/4 watt resistors
- For 24 volt logic, use 2200 ohm, 1/4 watt resistors

Connecting to an Indexer with Sink or Source 12-24 VDC Outputs

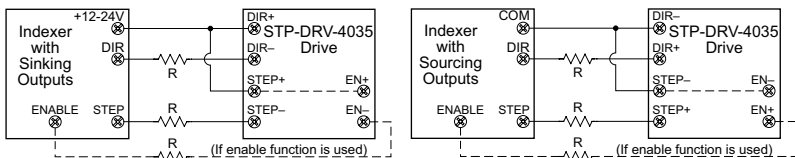

Connecting to a PLC with Sink or Source 12-24 VDC Outputs

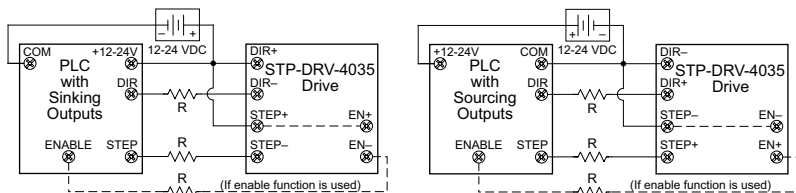

Note: Most PLCs can use 24 VDC Logic.

The Enable Input

The **ENABLE** input allows the user to turn off the current to the motor by providing a positive voltage between EN+ and EN-. The logic circuitry continues to operate, so the drive "remembers" the step position even when the amplifiers are disabled. However, the motor may move slightly when the current is removed depending on the exact motor and load characteristics.



Note: If you have no need to disable the amplifiers, you don't need to connect anything to the ENABLE input.

**Step Table
(half stepping)**

Step	A+	A-	B+	B-
0	open	open	+	-
1	+	-	+	-
2	+	-	open	open
3	+	-	-	+
4	open	open	-	+
5	-	+	-	+
6	-	+	open	open
7	-	+	+	-
8	open	open	+	-

Step 0 is the Power Up State

Setting Phase Current

Before you turn on the power supply the first time, you need to set the drive for the proper motor phase current. The rated current is usually printed on the motor label. The SureStep drive current is easy to set. If you wish, you can learn a simple formula for setting current and never need the manual again. Or you can skip to the table on the next page, find the current setting you want, and set the DIP switches according to the picture.

Current Setting Formula

Locate the bank of tiny switches near the motor connector. Five of the switches, DIP switch positions 5-9, have a value of current printed next to them, such as 0.1, 0.2, 0.4, 0.8 and 1.6. Each switch controls the amount of current, in amperes (A), that its label indicates in addition to the minimum current value of 0.4 Amps. **There is always a base current of 0.4 Amps, even with all five DIP switches set to the "off" position (away from their labels).** To add to that, slide the appropriate switches toward their labels on the PC board. You may need a small screwdriver for this.

DIP switch current total settings = step motor required phase current - 0.4 Amps always present base current

Example





Suppose you want to set the drive for 2.2 Amps per phase based on the step motor showing a phase current of 2.2 Amps. You need the base current of 0.4 Amps plus another 1.6 and 0.2 Amps.

$$2.2 = 0.4 + 1.6 + 0.2$$

Slide the 1.6 and 0.2 Amp DIP switches toward the labels as shown in the figure to the right.

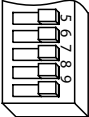
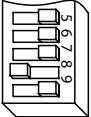
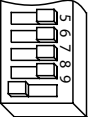
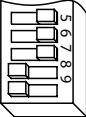
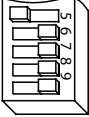
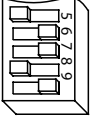
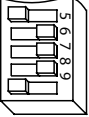
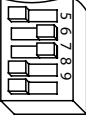
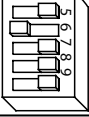
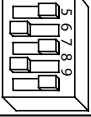
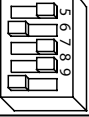
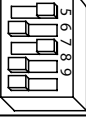
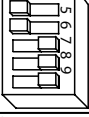
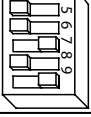
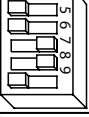
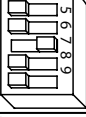
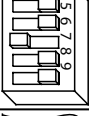
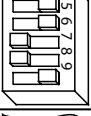
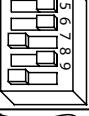
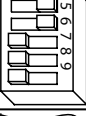
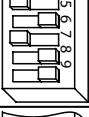
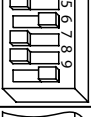
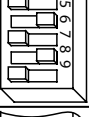
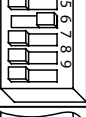
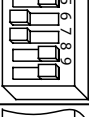
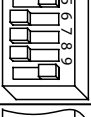
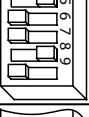
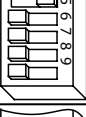

Current Setting Table

0.4 0.1 0.2 0.4 0.8 1.6 	1.2 0.1 0.2 0.4 0.8 1.6 	2.0 0.1 0.2 0.4 0.8 1.6 	2.8 0.1 0.2 0.4 0.8 1.6 	Factory Default
0.5 0.1 0.2 0.4 0.8 1.6 	1.3 0.1 0.2 0.4 0.8 1.6 	2.1 0.1 0.2 0.4 0.8 1.6 	2.9 0.1 0.2 0.4 0.8 1.6 	
0.6 0.1 0.2 0.4 0.8 1.6 	1.4 0.1 0.2 0.4 0.8 1.6 	2.2 0.1 0.2 0.4 0.8 1.6 	3.0 0.1 0.2 0.4 0.8 1.6 	
0.7 0.1 0.2 0.4 0.8 1.6 	1.5 0.1 0.2 0.4 0.8 1.6 	2.3 0.1 0.2 0.4 0.8 1.6 	3.1 0.1 0.2 0.4 0.8 1.6 	
0.8 0.1 0.2 0.4 0.8 1.6 	1.6 0.1 0.2 0.4 0.8 1.6 	2.4 0.1 0.2 0.4 0.8 1.6 	3.2 0.1 0.2 0.4 0.8 1.6 	
0.9 0.1 0.2 0.4 0.8 1.6 	1.7 0.1 0.2 0.4 0.8 1.6 	2.5 0.1 0.2 0.4 0.8 1.6 	3.3 0.1 0.2 0.4 0.8 1.6 	
1.0 0.1 0.2 0.4 0.8 1.6 	1.8 0.1 0.2 0.4 0.8 1.6 	2.6 0.1 0.2 0.4 0.8 1.6 	3.4 0.1 0.2 0.4 0.8 1.6 	
1.1 0.1 0.2 0.4 0.8 1.6 	1.9 0.1 0.2 0.4 0.8 1.6 	2.7 0.1 0.2 0.4 0.8 1.6 	3.5 0.1 0.2 0.4 0.8 1.6 	





Microstepping

Most step motor drives offer a choice between full step and half step resolutions. In most full step drives, both motor phases are used all the time. Half stepping divides each step into two smaller steps by alternating between both phases on and one phase on. Microstepping drives like the SureStep drive precisely control the amount of current in each phase at each step position as a means of electronically subdividing the steps even further. The SureStep drive offers a choice of half step and three microstep resolutions. The highest setting divides each full step into 50 microsteps, providing 10,000 steps per revolution when using a 1.8° motor.

In addition to providing precise positioning and smooth motion, microstep drives can be used to provide motion in convenient units. When the drive is set to 2,000 steps/rev (1/10 step) and used with a 5 pitch lead screw, you get .0001 inches/step.

Setting the step resolution is easy. Look at the dip switch on the SureStep drive. Next to switches 2 and 3, there are labels on the printed circuit board. Each switch has two markings on each end. Switch 2 is marked 1/5, 1/10 at one end and 1/5, 1/50 at the other. Switch 3 is labeled 1/2, 1/5 and 1/10, 1/50. To set the drive for a resolution, push both switches toward the proper label. For example, if you want 1/10 step, push switch 2 toward the 1/10 label (to the left) and push switch 3 toward 3 toward 1/10 (on the right).

Please refer to the table below and set the switches for the resolution you want.

	<p>400 STEPS/REV (HALF)</p> 	<p>2,000 STEPS/REV (1/10)</p> 
Factory Default	<p>1,000 STEPS/REV (1/5)</p> 	<p>10,000 STEPS/REV (1/50)</p> 

Idle Current Reduction

Your drive is equipped with a feature that automatically reduces the motor current by 50% anytime the motor is not moving. This reduces drive heating by about 50% and lowers motor heating by 75%. This feature can be disabled if desired so that full current is maintained at all times. This is useful when a high holding torque is required. To minimize motor and drive heating we highly recommend that you enable the idle current reduction feature unless your application strictly forbids it.

Idle current reduction is enabled by sliding switch #4 toward the *50% IDLE* label, as shown in the sketch below. Sliding the switch away from the *50% IDLE* label disables the reduction feature.



**Idle Current Reduction
Selected
(Factory Default)**



No Current Reduction

Self Test

The SureStep drive includes a self test feature. This is used for trouble shooting. If you are unsure about the motor or signal connections to the drive, or if the SureStep drive isn't responding to your step pulses, you can turn on the self test.

To activate the self test, slide switch #1 toward the *TEST* label. The drive will slowly rotate the motor, 1/2 revolution forward, then 1/2 rev backward. The pattern repeats until you slide the switch away from the *TEST* label. The SureStep drive always uses half step mode during the self test, no matter how you set switches 2 and 3. The self test ignores the *STEP* and *DIRECTION* inputs while operating. The *ENABLE* input continues to function normally.

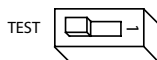

Self Test ON



**Self Test OFF
(Factory Default)**

Mounting the Drive

You can mount your drive on the wide or the narrow side of the chassis. If you mount the drive on the wide side, use #4 screws through the four corner holes. For narrow side mounting applications, you can use #4 screws in the two side holes.

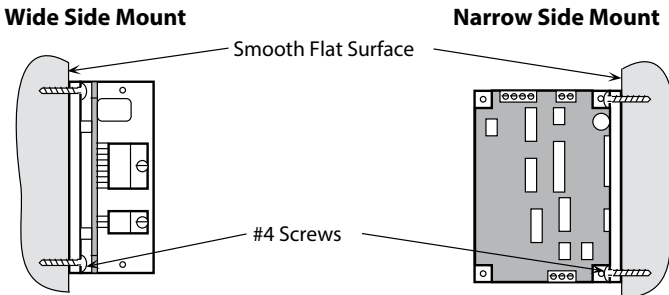

Unless you are running at 1 Amp/phase motor current or below, you may need a heat sink. Often, the metal subpanel being used for the control system will make an effective heat sink.

The amplifiers in the drive generate heat. Unless you are running at 1 amp or below, you may need a heat sink. To operate the drive continuously at maximum power you must properly mount it on a heat sinking surface with a thermal constant of no more than 4°C/Watt. Often, the metal enclosure of your system will make an effective heat sink.

Never use your drive in a space where there is no air flow or where other devices cause the surrounding air to be more than 70°C. Never put the drive where it can get wet or where metal particles can get on it.

Dimensions

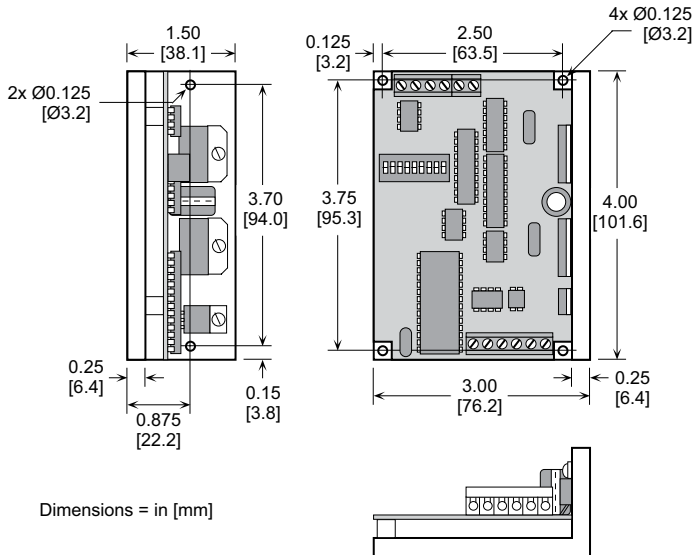

BLANK
PAGE

SURESTEP™
ADVANCED DC
MICROSTEPPING DRIVES



CHAPTER
4

In This Chapter...

Features	4-2
Specifications	4-3
Typical Wiring Diagram	4-4
Connection Locations & Pin-out	4-4
Connecting the Power Supply	4-6
Connecting the I/O	4-7
SureStep™ Drive Digital Inputs	4-7
Connecting STEP and DIR to 5V TTL Logic	4-7
Connecting STEP and DIR to Logic Other Than 5V TTL Level	4-8
Connections to the EN Input	4-9
Connecting the Analog Input	4-10
Connecting the Digital Output	4-10
LED Display Codes	4-12
Drive Configuration	4-15
Mounting the Drive	4-17
Drive Heating	4-17
Dimensions and Mounting Slot Locations	4-17

Features

- Max 5A, 48V and max 10A, 80V models available
- Software configurable
- Programmable microsteps
- Internal indexer (via ASCII commands)
- Self test feature
- Idle current reduction
- Anti-resonance
- Torque ripple smoothing
- Step, analog, and serial communication inputs



Specifications

SureStep™ Series Specifications – Microstepping Drives			
Microstepping Drive	STP-DRV-4850	STP-DRV-80100	
Drive Type	Advanced microstepping drive with pulse or analog input, serial communication, & indexing capability		
Output Current	0.1–5.0 A/phase (in 0.01A increments)	0.1–10.0 A/phase (in 0.01A increments)	
Input Voltage (external p/s required)	24–48 VDC (nominal) (range: 18–53 VDC)	24–80 VDC (nominal) (range: 18–88 VDC)	
Configuration Method	SureMotion Pro software		
Amplifier Type	MOSFET, dual H-bridge, 4-quadrant		
Current Control	4-state PWM @ 20 kHz		
Protection	Over-voltage, under-voltage, over-temperature, external output faults (phase-to-phase & phase-to-ground), inter-amplifier shorts		
Recommended Input Fusing	Fuse: 4A 3AG delay (ADC #MDL4) Fuse Holder: ADC #DN-F6L110	Fuse: 6.25A 3AG delay (ADC #MDL6-25) Fuse Holder: ADC #DN-F6L110	
Input Signals	Input Circuit	Opto-coupler input with 5 to 15 mA input current; Logic Low is input pulled to 0.8 VDC or less; Logic High is input 4 VDC or higher (see pages 4-8 and 4-9 for how to use input voltages higher than 5VDC)	
	Step/Pulse	Optically isolated, differential, 5V, 330Ω; Min pulse width = 250 ns, Max pulse frequency = 2MHz	
	Direction	Adjustable bandwidth digital noise rejection feature FUNCTIONS: step & direction, CW/CCW step, A/B quadrature, run/stop & direction, jog CW/CCW, CW/CCW limits	
	Enable	Optically isolated, 5–12V, 680Ω; min pulse width = 25µs, max pulse frequency = 20kHz FUNCTIONS: motor enable, alarm reset, speed select (oscillator mode)	
	Analog	Range: 0–5 VDC; Resolution: 12 bit; FUNCTION: speed control	
Output Signal	Optically isolated, 24V, 100mA max; FUNCTIONS: fault, motion, tach (3kHz max)		
Communication Interface	RS-232; RJ11 (6P4C) receptacle		
Non-volatile Memory Storage	Configurations are saved in FLASH memory on-board the DSP		
Features	Idle Current Reduction	Reduction range of 0–90% of running current after delay selectable in ms	
	Microstep Resolution	Software selectable from 200 to 51200 steps/rev in increments of 2 steps/rev	
	Modes of Operation	Pulse (step) & direction, CW/CCW, A/B quadrature, velocity (oscillator), SCL serial commands	
	Phase Current Setting	0.1–5.0 A/phase (in 0.01A increments)	0.1–10.0 A/phase (in 0.01A increments)
	Self Test	Checks internal & external power supply voltages, diagnoses open motor phases	
	Additional Features	Anti-resonance (Electronic Damping) Auto setup Serial Command Language (SCL) Host Control Step input signal smoothing (microstep emulation) Waveform (Torque Ripple) Smoothing	
Communication Port	RJ11 (6P4C)		
Removable Connectors	Motor & Power Supply: Screw term blocks Phoenix Contact 1757051 (30–12AWG) Signals: Screw terminal blocks Phoenix Contact 1803633 (30–14 AWG) AutomationDirect part number STP-CON-2 contains these replacement connectors.		
Maximum Humidity	90% non-condensing		
Storage Temperature	–20–80 °C [–4–176 °F] (mount to suitable heat sink)		
Operating Temperature	0–55 °C [32–158 °F] (mount to suitable heat sink)		
Drive Cooling Method	Natural convection (mount to suitable heat sink)		
Mounting	#6 mounting screws (mount to suitable heat sink)		
Dimensions	3.0 x 3.65 x 1.125 inches [76.2 x 92.7 x 28.6 mm]		
Weight	8 oz [227g] (approximate)		
Agency Approvals	CE		

Typical Wiring Diagram

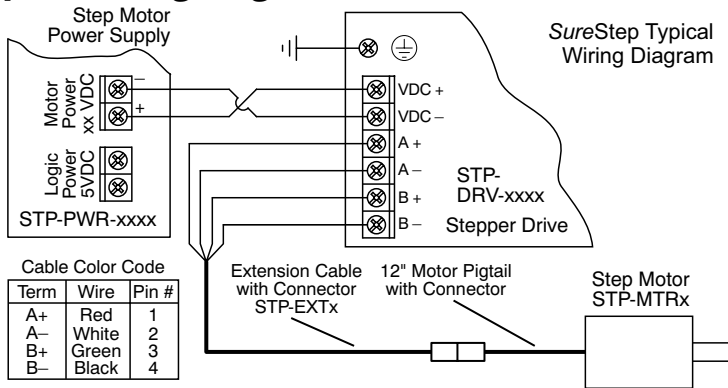

Connection Locations & Pin-out

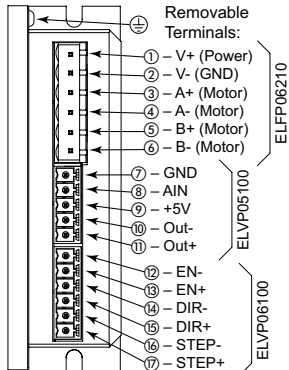

Terminal block part #s (shown) are Amphenol PCD (www.amphenolpcd.com) Replacement connector kit STP-CON-2 contains all the above connectors

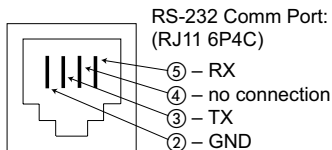
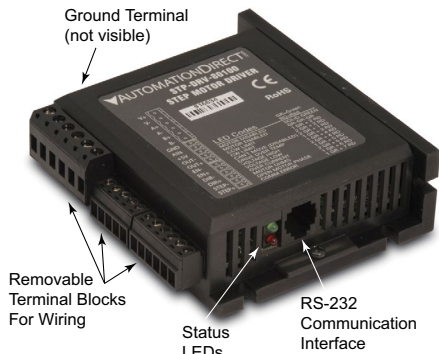

External wiring is connected using three separate pluggable screw terminal connectors. The power connections share a six position connector, the digital inputs share another six position connector, and the analog input and digital output share a five position connector.

Connecting the Motor



Warning: When connecting a step motor to a SureStep™ advanced microstepping drive, be sure that the motor power supply is switched off. When using a motor not supplied by AutomationDirect, secure any unused motor leads so that they can't short out to anything. Never disconnect the motor while the drive is powered up. Never connect motor leads to ground or to a power supply. (See the Typical Wiring Diagram shown in this chapter for the step motor lead color code of AutomationDirect supplied motors.)

Four lead motors

Four lead motors can only be connected one way, as shown below.

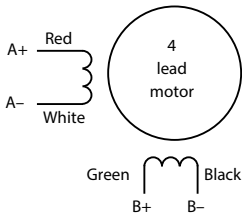

4 Leads



All AutomationDirect SureStep™ MTR and MTRL motors are four lead bipolar step motors.

Six Lead Motors

Six lead motors can be connected in series or center tap. Motors produce more torque at low speeds in series configuration, but cannot run as fast as in the center tap configuration. In series operation, the motor should be operated at 30% less than rated current to prevent overheating.

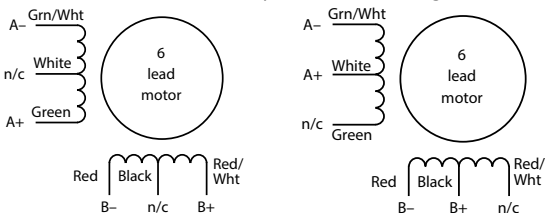

6 Leads Series Connected

6 Leads Center Tap Connected



Step motor wire lead colors vary from one manufacturer to another.

Eight Lead Motors

Eight lead motors can also be connected in two ways: series or parallel. Series operation gives you more torque at low speeds, but less torque at high speeds. When using series connection, the motor should be operated at 30% less than the rated current to prevent overheating. Parallel operation allows greater torque at high speeds. When using parallel connection, the current can be increased by 30% above rated current. Care should be taken in either case to assure the motor does not overheat.

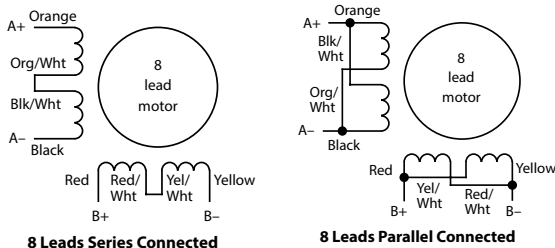

Step motor wire lead colors vary from one manufacturer to another. The example above only pertains to STP-MTRAC-34075(x) and 34115(x) SureStep Motors. For NEMA 42 wire colors, see "Connecting a STP-MTRAC(H)-42 Motor" in Chapter 7.

Connecting the Power Supply

An STP-PWR-xxxx power supply from AutomationDirect is the best choice to power the step motor drive. If you need information about choosing a different power supply, refer to the section entitled "Choosing a Power Supply" in Chapter 7: "SureStep System Power Supplies."

If your power supply does not have a fuse on the output or some kind of short circuit current limiting feature, you need a fuse between the drive and the power supply. Install the fuse on the + power supply lead.

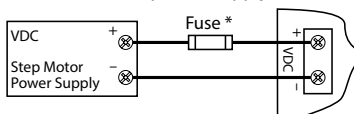

* External fuse not required when using an STP-PWR-xxxx P/S; fuse is internal.

Further information about braking accessories and regeneration clamping can be found in Appendix A: "SureStep Accessories" and the STP-DRVA-RC-050(A) REGENERATION CLAMP datasheet.



Warning: Connect the motor power supply "+" terminal to the drive "+ VDC" terminal, and connect the power supply "-" terminal to the drive "VDC-" terminal.

Use wire no smaller than 18 gauge, and be careful not to reverse the wires. Reverse connection will destroy your drive and void the warranty.

Connecting the I/O

SureStep™ Drive Digital Inputs

The SureStep advanced drives include two high speed 5V digital inputs (STEP and DIR), and one standard speed 5-12V input (EN).

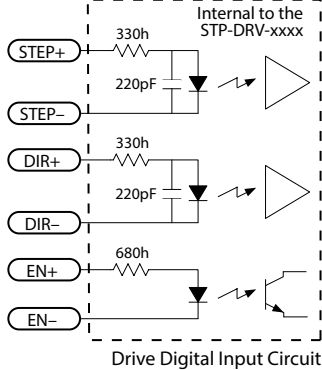

The digital inputs are optically isolated to reduce electrical noise problems. There is no electrical connection between the control and power circuits within the drive, and input signal communication between the two circuits is achieved by infrared light. Externally, the drive's motor power and control circuits should be supplied from separate sources, such as from a step motor power supply with separate power and logic outputs.

For bidirectional rotation, supply a source of step pulses to the drive at the STEP+ and STEP- terminals, and a directional signal at the DIR+ and DIR- terminals.

The ENABLE input allows the logic to turn off the current to the step motor by providing a signal to the EN+ and EN- terminals. The EN+ and EN- terminal can be left unconnected if the enable function is not required.

All logic inputs can be controlled by a DC output signal that is either sinking (NPN), sourcing (PNP), or differential.

Connecting STEP and DIR to 5V TTL Logic

Connecting to an Indexer with Sinking Outputs

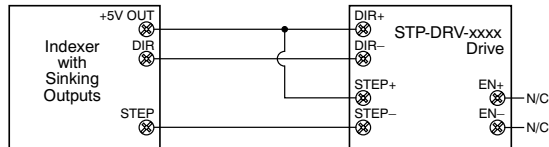

Connecting to an Indexer with Sourcing Outputs

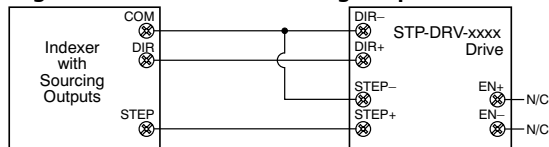

Connecting to an Indexer with Differential Outputs

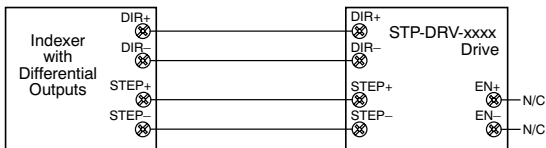

Many high speed indexers have differential outputs.

Wiring for Encoder Following

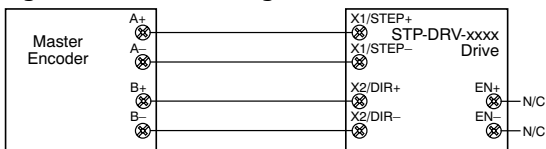

Connecting STEP and DIR to Logic Other Than 5V TTL Level

Some step and direction signals, especially those of PLCs, don't use 5 volt logic. You can connect signal levels as high as 24 volts to a SureStep advanced drive if you add external dropping resistors to the STEP, DIR and EN inputs.

- For 12V logic, use 820Ω, 1/4W resistors
- For 24V logic, use 2200Ω, 1/4W resistors



Most PLCs can use 24 VDC Logic.

Connecting to an Indexer with Sink or Source 12-24 VDC Outputs



Warning: 5VDC is the maximum voltage that can be applied directly to a high speed input (STEP and DIR). If using a higher voltage power source, install resistors to reduce the voltage at the inputs. Do NOT apply an AC voltage to an input terminal.

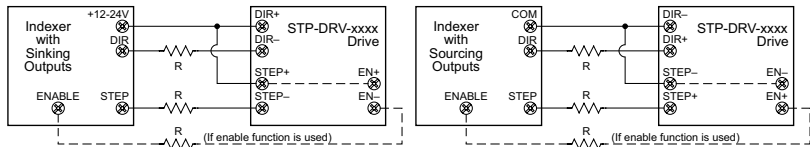

Connecting to a PLC with Sink or Source 12-24 VDC Outputs

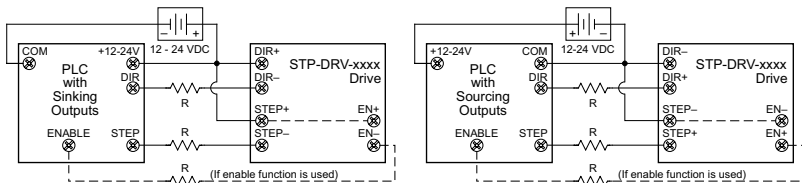

Connecting to Mechanical Switches at 24 VDC

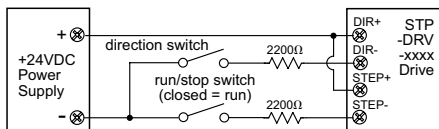

Connections to the EN Input

The ENABLE input allows the user to turn off the current to the motor by providing a 5-12 VDC positive voltage between EN+ and EN-. The logic circuitry continues to operate, so the drive “remembers” the step position even when the amplifiers are disabled. However, the motor may move slightly when the current is removed depending on the exact motor and load characteristics.



Warning: 12VDC is the maximum voltage that can be applied directly to the standard speed EN input. If using a higher voltage power source, install resistors to reduce the voltage at the input. Do NOT apply an AC voltage to an input terminal.

Connecting ENABLE Input to Relay or Switch

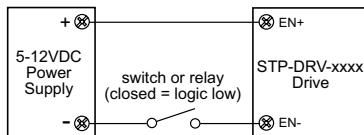

Connecting ENABLE Input to NPN Proximity Sensor

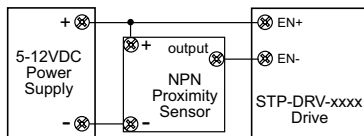

Connecting ENABLE Input to PNP Proximity Sensor

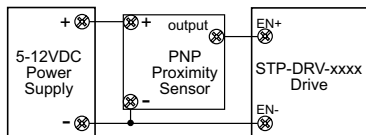

Leave the ENABLE input unconnected if you do not need to disable the amplifiers.

Connecting the Analog Input

The SureStep advanced drives have one 0-5 VDC analog input.

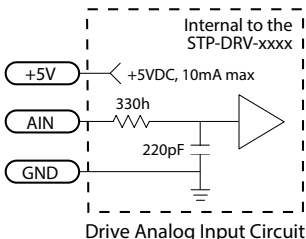

Connecting AI to Analog Signal

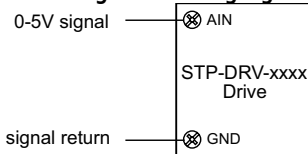

Connecting AI to Potentiometer

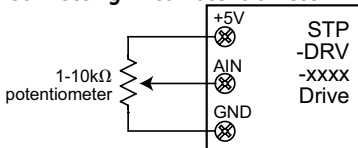

Warning: The analog input is NOT optically isolated, and must be used with care.

It may operate improperly and it can be damaged if the system grounds are not compatible.

Connecting the Digital Output

The SureStep advanced drives have one digital output (DO) that has separate positive (+) and negative (-) terminals, and can be used to sink or source current.

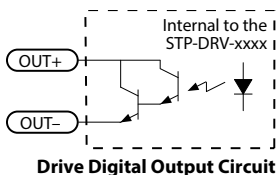

Connecting DO to Inductive Load

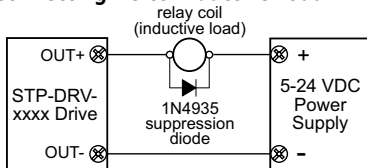

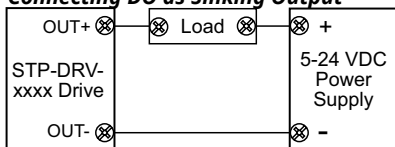
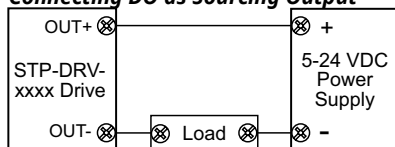















Connecting DO as Sinking Output**Connecting DO as Sourcing Output**

Warning: Do NOT connect the digital output to a voltage greater than 30VDC. The current through each DO terminal must not exceed 100mA.

LED Display Codes

The LEDs on the Surestep advanced drives flash in the sequences shown in the table below to denote various alarm states.

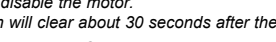
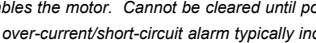
STP-DRV-4850 and 80100 Alarm Codes		
Alarm Code	LED Sequence	Alarm Description
SG	 Solid green	No alarm, motor disabled
FG	 Fast green	Factory use
01	 Flashing green	No alarm, motor enabled
10	 Flashing red	Configuration or memory error ¹
11	 1 red, 1 green	Motor stall (optional encoder only) ⁴
12	 1 red, 2 green	Move attempted while drive disabled
21	 2 red, 1 green	CCW limit
22	 2 red, 2 green	CW limit
31	 3 red, 1 green	Drive overheating
32	 3 red, 2 green	Internal voltage out of range ²
33	 3 red, 3 green	Factory use
41	 4 red, 1 green	Power supply overvoltage ²
42	 4 red, 2 green	Power supply undervoltage
43	 4 red, 3 green	Flash memory backup error
51	 5 red, 1 green	Over current / short circuit ^{2, 3}
61	 6 red, 1 green	Open motor winding ²
62	 6 red, 2 green	Bad encoder signal (optional encoder only) ⁴
71	 7 red, 1 green	Serial communication error ⁵
72	 7 red, 2 green	Flash memory error

1 - Does not disable the motor.

The alarm will clear about 30 seconds after the fault is corrected.

2 - Disables the motor. Cannot be cleared until power is cycled.

3 - The over-current/short-circuit alarm typically indicates that an electrical fault exists somewhere in the system external to the drive. This alarm does not serve as motor overload protection.

4 - This alarm only occurs on STP-MTRD advanced integrated motor/drives

5 - This alarm does not occur on STP-DRV-6575 or standard integrated motor/drives

Alarm Code Definitions

Alarm Code	Error	Description	Corrective Action
SG	No alarm, motor disabled	No faults active, Circuit is closed between EN+ and EN-.	N/A
01	No alarm, motor enabled	No faults active, Circuit is open between EN+ and EN-.	N/A
10	Configuration or memory error	Memory error detected when trying to load config from flash on powerup.	Restart device. No fix if restart doesn't work. Return to manufacturer for correction.
11	Motor stall (optional encoder only)	Motor torque demand exceeded capability and the motor skipped steps. This is configured in SureMotion Pro.	Increase torque utilization if it's not already maxed out, otherwise decrease the torque demand by modifying the move profile, or put in a larger motor.
12	Move attempted while drive disabled	Drive is disabled and move attempted.	Reset alarm, enable motor, and move again.
21	CCW limit	CCW limit is reached. The digital input that has been assigned CCW limit has been activated.	Unblock the CCW sensor (open the circuit) or redefine the input with SureMotion Pro.
22	CW limit	CW limit is reached. The digital input that has been assigned CW limit has been activated.	Unblock the CCW sensor (open the circuit) or redefine the input with SureMotion Pro.
31	Drive overheating	The drive's internal temperature is too high.	If the drive is operating within its standard range (input voltage and output current are OK), more heat must be removed from the drive during operation. For Advanced drives (see "Mounting the Drive" on page 4-14), ensure the drive is mounted to a metal surface that can dissipate the drive's heat. For Integrated motor/drives, see "Mounting" on page 5-13. For both types of drives: If the mounting surface cannot pull enough heat away from the drive, forced airflow (from a fan) may be required to cool the drive.
32	Internal voltage out of range	Gate voltage, 5V rail, or 3V rail are out of spec.	Ensure adequate supply voltage (in very rare cases, low input voltages combined with fast accelerations can draw down the gate voltage) and try again. If persistent, RMA is required.

Alarm Code	Error	Description	Corrective Action
41	Power supply overvoltage	The DC voltage feeding the drive is above the allowable level.	<p>Decrease the input voltage. Linear power supplies do not output a fixed voltage: the lighter the output current, the higher the output voltage will float. If a linear supply's voltage floats above the drive's max voltage, you can install a small power resistor across the linear power supply's output to provide some load that will help pull down the floating voltage. Consider using a switching power supply such as the Rhino PSB power supply series.</p> <p>Overvoltage can also be fed back into a system by regeneration (when an overhauling load pushes energy back into the motor). In an application with regen problems, install an STP-DRVA-RC-050 regen clamp to help dissipate the extra energy. (The regen clamp will not help with the floating linear power supply that floats too high, but it will help with excess voltage generated from an overhauling load.)</p>
42	Power supply undervoltage	The DC voltage feeding the drive is below the allowable level.	Correct the power supply. If this error occurs during operation, the power supply is most likely undersized. A sudden high current demand can cause an undersized power supply to dip in output voltage.
43	Flash memory backup error	Memory error detected when trying to load config from flash on powerup.	Restart device. No fix if restart doesn't work. Return to manufacturer for correction.
51	Over current / short circuit	Motor leads shorted - only checked on powerup.	Check and fix motor wiring.
61	Open motor winding	Motor leads not connected - only checked on powerup.	Check and fix motor wiring.
62	Bad encoder signal (optional encoder only)	Noisy or otherwise incorrectly formatted encoder signal (lack of A or B, lack of differential signal).	Check encoder wiring, always use differential encoders (or use checkbox in SureMotion Pro to disable this error when using single ended).
71	Serial communication error	Catch-all error for something wrong with serial communications. See CE command in HCR for details.	If drive can communicate, CE can give a precise diagnosis. If not, refer to the Serial Communications part of the HCR for troubleshooting.
72	Flash memory error	Memory error detected when trying to load config from flash on powerup.	Restart device. No fix if restart doesn't work. Return to manufacturer for correction.

Drive Configuration

You need to configure your drive for your particular application before using the drive for the first time. The SureStep advanced microstepping drives require SureMotion Pro (part number SM-PRO, free download at Automationdirect.com) drive configuration software for this purpose. Please refer to “Chapter 10: SureMotion Pro Configuration Software” or the software’s help file for more detailed information on configuring the drive. The software contains instructions for installation on a PC, and instructions for configuring the drives. Configuration settings include:

- drive model
- motor characteristics
- motion control mode
- I/O configuration

Anti-Resonance / Electronic Damping

Step motor systems have a tendency to resonate at certain speeds. SureStep advanced drives automatically calculate the system’s natural resonate frequency, and apply damping to the control algorithm. This greatly improves midrange stability, allows higher speeds and greater torque utilization, and improves settling times.

This feature is on by default, but it can be turned off using the “Motor...” icon of the SureMotion Pro software.

Idle Current Reduction

This feature reduces current consumption while the system is idle, and subsequently reduces drive and motor heating. However, reducing the idle current also reduces the holding torque.

The percent and delay time of the idle current reduction can be adjusted using the “Motor...” icon of the SureMotion Pro software.

Microstep Resolution

The microstep resolution (steps/rev) can be selected using the “Motion & I/O...” icon of the SureMotion Pro software, and selecting “Pulse and Direction Mode”.

Modes of Operation

Modes of operation are selectable via the SureMotion Pro software “Motion & I/O...” icon.

- Pulse & Direction Mode
 - Pulse & Direction
 - CW & CCW Pulse
 - A/B Quadrature
- Velocity (Oscillator) Mode
- Serial Command Language (SCL)

Phase Current Setting

Motor phase current settings are available through the SureMotion Pro software “Motor...” icon and the “Running Current” settings.

Serial Command Language (SCL) Host Control

SureStep advanced drives can accept serial commands from a host PC or PLC.

This feature can be selected using the “Motion & I/O...” icon of the SureMotion Pro software, and selecting Serial Command Language.

Step Smoothing Filter (Command Signal Smoothing & Microstep Emulation)

The Step Smoothing Filter setting is effective only in the Step (Pulse) & Direction mode. It includes command signal smoothing and microstep emulation to soften the effect of immediate changes in velocity and direction, therefore making the motion of the motor less jerky. An added advantage is that it can reduce the wear on mechanical components.

This feature can be modified by using the “Motion & I/O...” icon of the SureMotion Pro software, and selecting “Pulse and Direction Mode”.

Waveform (Torque Ripple) Smoothing

All step motors have an inherent low speed torque ripple that can affect the motion of the motor. SureStep advanced drives can analyze this torque ripple and apply a negative harmonic to negate this effect. This feature gives the motor much smoother motion at low speeds.

This feature is on by default, and is factory preset for standard motors. It can be turned off or on using the “Motor...” icon of the SureMotion Pro software. To set Waveform Smoothing for custom motors, select “Define Custom Motor...” and the “Waveform Smoothing” “Wizard...”.



CAUTION: Power down the SureStep drive before plugging a communication cable into the comm port of the drive. Failure to do so may result in damage to the drive comm port!

Mounting the Drive

You can mount your drive on the wide or the narrow side of the chassis using #6 screws. Since the drive amplifiers generate heat, the drive should be securely fastened to a smooth, flat metal surface that will help conduct heat away from the chassis. If this is not possible, then forced airflow from a fan may be required to prevent the drive from overheating.

- Never use your drive in a space where there is no air flow or where the ambient temperature exceeds 40 °C (104 °F).
- When mounting multiple STP-DRV-xxxx drives near each other, maintain at least one half inch of space between drives.
- Never put the drive where it can get wet.
- Never allow metal or other conductive particles near the drive.

Drive Heating

For information on drive heating, please see Chapter 8: SureStep System Power Supplies.

Dimensions and Mounting Slot Locations

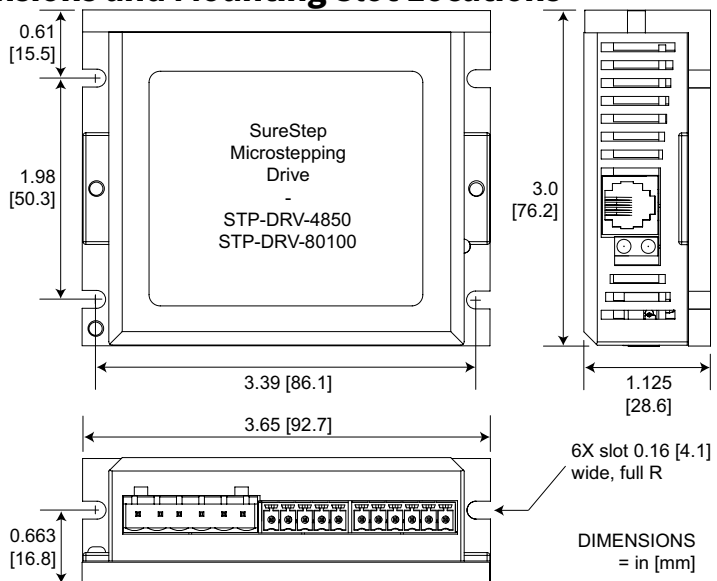

BLANK
PAGE

SURESTEP™
STP-DRVAC-24025
MICROSTEPPING DRIVE



CHAPTER
5

In This Chapter...

Features	5-2
Specifications	5-3
Mounting the Drive	5-4
Dimensions	5-4
Wiring Connections and Configuration Switches	5-5
STP-DRVAC-24025	5-5
Connecting the Power Supply	5-6
Connecting the Motor	5-7
Selecting the Motor	5-8
Torque-Speed Curves	5-8
Connecting the I/O	5-9
Step/Direction Mode and CW/CCW Mode Jumper	5-9
Connecting the Input Signals - Step and Direction	5-9
The Enable Input	5-10
Connecting the Fault Output Setting	5-11
Drive Configuration	5-12
Microstepping	5-13
Setting Running Current	5-13
Idle Current Reduction	5-14
Step Noise Filter	5-14
Load Inertia	5-14
Smoothing Filter	5-14
Self Test	5-15
Alarm Codes	5-16

Features

The STP-DRVAC-24025 AC input drive is based on advanced digital current control technology and provides high torque, low noise, and low vibration. Many of the operational parameters are switch selectable.

- Advanced digital current control provides excellent high speed torque
- Auto-setup probes the motor when power is applied and configures and fine tunes motor current control and anti-resonance gain settings
- Uses universal AC input 90 to 240 VAC, AC input voltage must be selected by switch
- Speed range - up to 50 rps
- Microstep resolution - switch selectable, 16 settings from 200 to 25600 steps/rev
- Running current - peak setting, switch selectable, 8 settings from 0.6 to 2.5 A
- Idle current - automatic reduction of running current 1 second after the motor stops, switch selectable, 2 settings, 50/90% of running current
- Anti resonance - raises the system-damping ratio to eliminate midrange instability and allow stable operation throughout the speed range of the motor, switch selectable, 2 settings, low to high inertia loads
- Control modes - step/direction pulse input (default) or CW/CCW pulse input, internal jumper switch selectable
- Input signal filter - filters out unwanted noise that can cause extra steps, switch selectable, 150kHz or 2MHz
- Step smoothing filter (microstep emulation) - performs high resolution stepping by synthesizing coarse steps into fine micro-steps, switch selectable, ON or OFF
- Self test - performs a 2 rev 0.5 rps, forward and reverse move test, switch selectable, ON or OFF
- Motor selection - a 16-bit rotary switch is used to select the desired motor database which is pre-loaded at the factory



Specifications

Sure Step™ Microstepping Drive Specifications	
Part Number	STP-DRVAC-24025
Input Power	90-240 VAC
Output Current	0.6-2.5 A
Current Controller	MOSFET, dual H-bridge and 4-quadrant PWM at 20kHz
Input Signals	Step 5-24 VDC nominal (range: 4-28 VDC); optically isolated, differential. Maximum pulse frequency = 150kHz or 2MHz (user selectable). Minimum pulse width: 3 usec at 150 kHz setting SW9 1 usec at 2 MHz setting SW9 Function = Step or Step CW pulse.
	Direction 5-24 VDC nominal (range: 4-28 VDC); optically isolated, differential. Maximum pulse frequency = 150kHz or 2MHz (user selectable). Minimum pulse width: 3 usec at 150 kHz setting SW9 1 usec at 2 MHz setting SW9 Function = Direction or Step CCW pulse.
	Enable 5-24 VDC nominal (range: 4-30 VDC); (5mA @ 4V; 15 mA @ 30V); Optically isolated, differential. Max pulse frequency: 10kHz Minimum pulse width: 500usec Function = disable motor when closed.
Output Signal	Fault 30VDC max / 100mA max, optically isolated photodarlington, sinking or sourcing. Function = closes on drive fault.
Internal Jumper Selectable Function	Step Pulse Type Step and Direction: Step signal = step/pulse; Direction signal = direction. Step CW & CCW: Step signal = CW step; Direction signal = CCW step.
DIP Switch Selectable Functions	Step Resolution Selectable from 200 steps/rev up to 25600 steps/rev using SW1-4.
	Running Current The output current drive to the motor is set by the SW5, SW6, and SW7 switches and can be changed from 0.6 A to 2.5 A per phase.
	Idle Current Reduction Reduce power consumption and heat generation by limiting motor idle current to 90% or 50% of running current. (Holding torque is reduced by the same %.)
	Step Noise Filter Select 150kHz or 2MHz using SW9.
	Load Inertia Smoothing Filter Set the load inertia to 0-4x or 5-10x using SW10 (also referred to as anti-resonance)
	Selt Test Softens the effect of immediate changes in velocity and direction, making the motion of the motor less jerky. Can cause a small delay in following the control signal. Automatically rotate the motor back and forth two turns in each direction in order to confirm that the motor is operational.
Drive Cooling Method	Natural cooling or fan-forced cooling
Mounting	Use (2) M4 screws to mount to metal surface
Removable Connectors*	DEGSON: 2EDGK-7.62-02P-14-00A(H), 2 pin power connector 2EDGK-5.08-04P-14-00A(H), 4 pin motor connector 15EDGK-3.81-08P-14-00A(H), 8 pin I/O connector
Weight	0.88 kg [1lb 15oz]
Operating Temperature	0-85 °C [32-185 °F] (interior of electronics section)
Ambient Temperature	0-40 °C [32-104 °F]
Humidity	Maximum 90% non-condensing
Agency Approvals	CE, cURus

*Replacement connectors are available in connector kit STP-CON-6

Mounting the Drive

The STP-DRVAC-24025 drive can be mounted only on the narrow side of the chassis using (2) M4 screws in the holes at the back of the drive. Use forced air cooling such as a fan to operate the drive continuously at maximum power.

WARNING:

- Never mount the drive in a space where there is no air flow, or where other devices can heat the surrounding air to 40°C [104°F].
- Never put the drive where it can get wet, or where metal or other electrically-conductive particles can get on the circuitry.
- Always provide air flow around the drive. Minimum allowable spacing between multiple drives is 0.5 inches [13 mm].

Dimensions

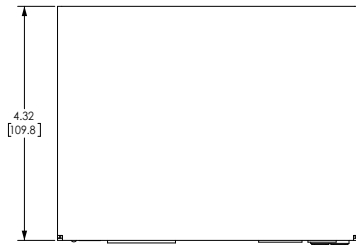
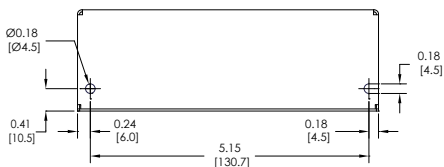

Dimensions = in [mm]

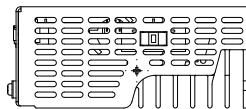
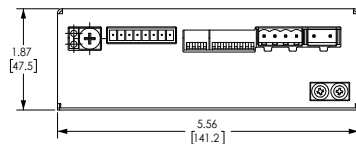

Wiring Connections and Configuration Switches

STP-DRVAC-24025

The following items are required to set up the STP-DRVAC-24025 drive:

- AC input of 90 to 240 VAC
- Pulse and direction signal
- A compatible step motor (STP-MTRAC-23 and -34 series recommended; the STP-MTRAC(H)-42x series will not work with this drive. The motors can accept the high voltage, but the drive does not supply enough current for the NEMA 42 motors)
- AC input voltage must be selected by switch

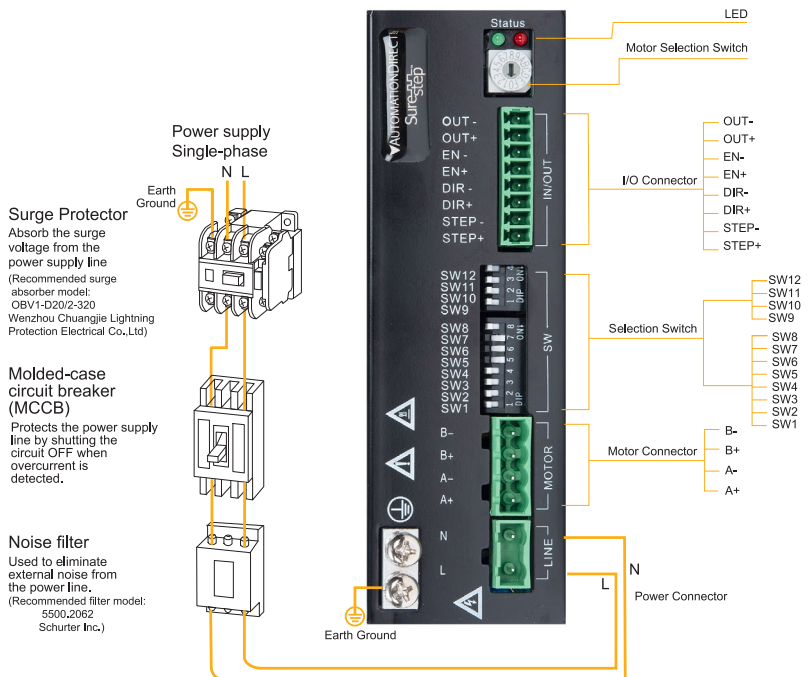

Connecting the Power Supply

DO NOT apply power until all connections to the drive have been made. Use a 4A fuse on the line connection for drive protection.

1. Select power input voltage. AC input voltage must be selected by switch. Check input voltage to avoid damage before powering on.



2. Wire the drive to the AC power source. Use 16 AWG wire for Line (L) and Neutral (N). Use 14 AWG for Earth Ground (G).

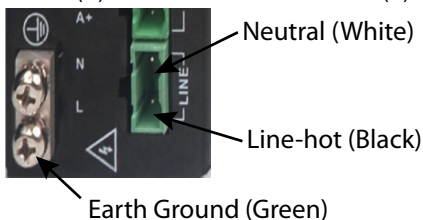

The STP-DRVAC-24025 contains a non-replaceable internal 5A fast acting fuse.



Warning: When connecting a step motor to the SureStep™ STP-DRVAC-24025 microstepping drive, be sure that the motor power supply is switched off. When using a motor not supplied by AutomationDirect, secure any unused motor leads so that they cannot short out to anything. Never disconnect the motor while the drive is powered up. Never connect motor leads to ground or to a power supply.

Connecting the Motor



Warning: When connecting a step motor to the SureStep™ STP-DRVAC-24025 microstepping drive, be sure that the motor power supply is switched off. When using a motor not supplied by AUTOMATIONDIRECT, secure any unused motor leads so that they cannot short out to anything. Never disconnect the motor while the drive is powered up. Never connect motor leads to ground or to a power supply.

Connect the drive to the motor. If using a non AutomationDirect motor, consult the motor specs for wiring information. It is very important to only use high bus voltage stepper motors with the STP-DRVAC-24025 as it outputs up to 340 volts to the motor. It is highly recommended that you use an AutomationDirect recommended motor that is equipped with a shielded cable. The NEMA23 and NEMA34 STP-MTRAC-x motors are specifically made to be used with the STP-DRVAC-24025 drive.

Always connect the motor's cable drain wire to the two screws next to the A+ terminal. The connecting of this drain wire not only grounds the motor frame but also connects the cable shield to minimize electrical interference.

The recommended AutomationDirect step motors for the STP-DRVAC-24025 include shielded cables and should always be wired in the series configuration as shown below. The STP-DRVAC-24025 has an internal voltage doubler when connected to 115VAC so the series configuration is required in order to limit the current output of the drive. If you are using a different manufacturer's drive that does not have a voltage doubler when connected to 110VAC then you should wire the STP-MTRAC-x motors in parallel to achieve the same phase current.

STP-MTRAC-23044(x), 23055(x),
23078(x), 34156(x)

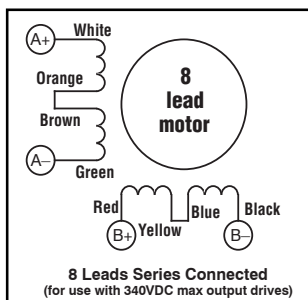

STP-MTRAC-34075(x), 34115(x)

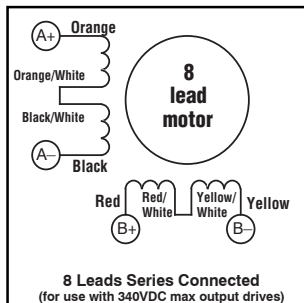

WARNING:
Always wire
STP-MTRAC
motors in
series when
using the STP-
DRVAC-24025.

Selecting the Motor

Each position of the 16-bit rotary switch selects a different motor, automatically setting the configuration parameters in the drive. The STP-DRVAC-24025 drive comes programmed with up to 6 SureStep motors as factory defaults. The remaining options are either reserved for future or factory use.



Warning: Do NOT use standard low-voltage stepper motors with the AC-input drive. Only use stepper motors rated for AC-input systems (such as the STP-MTRAC motors). The high bus voltage on the STP-DRVAC drive will overheat and damage standard stepper motors that are wound for lower-voltage DC systems.

If the motor selection is changed, the drive power supply will need to be cycled.



NOTE: Motor current is limited by the lower value between rotary switch setting and the Running Current dip switches. The default setting for the running current is 0.6 A for motor protection. Be sure to adjust this setting when selecting a motor.

For a custom motor, please select the closest comparable motor via the rotary switch, then use the DIP switches to configure motor current, anti-resonance, and other settings.

STP-DRVAC-24025 Motor Selection			
Rotary Switch Position	Motor	Rated Current (A/phase RMS)	Wiring
0-6	Reserved		
7	STP-MTRAC-23044(D)	0.71	Series
8	STP-MTRAC-23055(D)	0.71	Series
9	STP-MTRAC-23078(D)	0.71	Series
A	STP-MTRAC-34075(D)	2.15	Series
B	STP-MTRAC-34115(D)	2.05	Series
C	STP-MTRAC-34156(D)	2.55	Series
D-F	Reserved		

Connecting the I/O

The SureStep STP-DRVAC-24025 drive includes two high-speed 5–24 VDC digital inputs (STEP & DIR, or CW/CCW) accepting single-ended or differential signals, up to 2MHz depending on DIP SW9 selection , one 5–24 VDC digital input (EN), and one digital output (Fault).

The digital inputs are optically isolated to reduce electrical noise problems. There is no electrical connection between the control and power circuits within the drive, and input signal communication between the two circuits is achieved by infrared light.

For bidirectional rotation, supply a source of step pulses to the drive at the STEP+ and STEP- terminals, and a directional signal at the DIR+ and DIR- terminals.

The ENABLE input allows the logic to turn off the current to the step motor by providing a signal to the EN+ and EN- terminals.

All logic inputs can be controlled by a DC output signal that is either sinking (NPN), sourcing (PNP), or differential.

On the next couple of pages are examples for connecting various forms of outputs from both indexers and PLCs.

Step/Direction Mode and CW/CCW Mode Jumper

To adjust the STP-DRVAC-24025 drive to accept STEP CW and STEP CCW signals, remove the drive cover and move jumper J10 from the 1-2 position to the 2-3 position. Jumper J10 is located at the top of the main circuit board, just behind the white 4-pin connector. The CW signal should be connected to the STEP input and the CCW signal should be connected to the DIR input.

Connecting the Input Signals - Step and Direction

Connecting Drive to Indexer with Sourcing Outputs

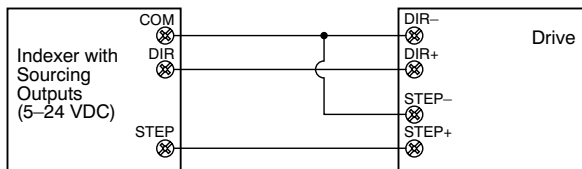

Connecting Drive to Indexer with Sinking Outputs

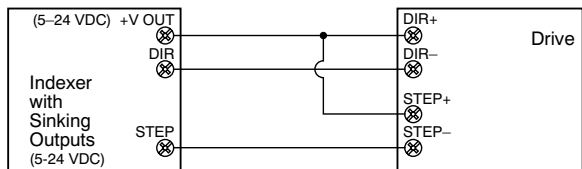

Connecting Drive to Indexer with Differential Outputs

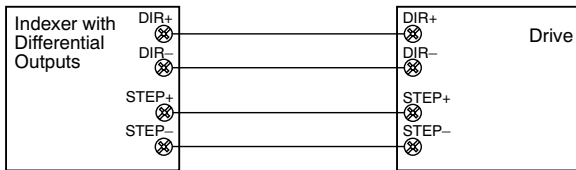

The Enable Input

The **ENABLE** input allows the user to turn off the current to the motor by providing a positive voltage between EN+ and EN-. The logic circuitry continues to operate, so the drive “remembers” the step position even when the amplifiers are disabled. However, the motor may move slightly when the current is removed depending on the exact motor and load characteristics.

Connecting Drive EN to Switch or Relay

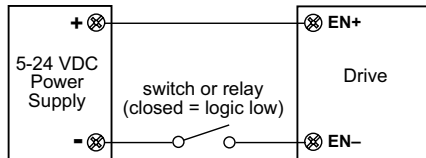

Connecting Drive EN to NPN

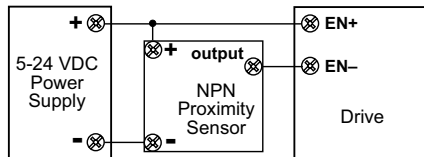

Connecting the Fault Output Setting

The SureStep STP-DRVAC-24025 has one digital output that has separate positive (+) and negative (-) terminals, and can be used to sink or source current. Do not connect more than 30VDC. Current must not exceed 80mA.

Connecting Drive's Fault Output to Inductive Relay

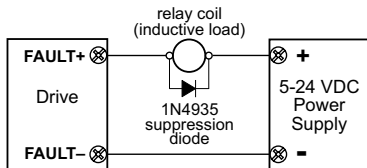

Connecting Fault Output as Sinking Output

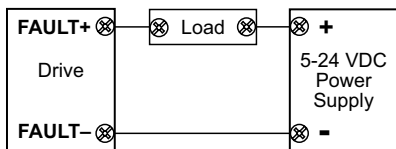

Connecting Fault Output as Sourcing Output

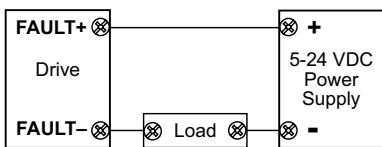

Drive Configuration

You need to configure your drive for your particular application before using the drive for the first time. The SureStep STP-DRVAC-24025 microstepping drive offers several features and configuration settings, including:

Drive Configuration Settings		
Feature	Description	Configuration Method
Motor Phase Current	Select motor based on part number. Automatically sets drive to run the selected motor as optimally as possible.	Choose motor via rotary switch
Mode of Operation (Step Pulse Type)	Step and Direction (default): Step signal = step/pulse; Direction signal = direction. Step CW & CCW: Step signal = CW step; Direction signal = CCW step.	Jumper J10
Step Pulse Noise Filter	Select 150 kHz or 2MHz	DIP switch SW9
Running Current	The output current is set by the SW5, SW6 and SW7 switches. NOTE: Drive's running current will be limited by the lower value between motor selection rotary switch or the dip current switch	DIP switch SW5, SW6, SW7
Idle Current Reduction	Reduce power consumption and heat generation by limiting motor idle current to 90% or 50% of running current. (Holding torque is reduced by the same %.)	DIP switch SW8
Load Inertia	Anti-resonance and damping feature improve motor performance. Set motor and load inertia range to 0-4x or 5-10x.	DIP switch SW10
Step Resolution	For smoother motion and more precise speed, set the pulse per revolution value as needed.	DIP switch SW1, SW2, SW3, SW4
Self Test	Automatically rotates the motor back and forth 1/2 a revolution in each direction in order to confirm that the motor is operational.	DIP switch SW12
Step Smoothing Filter	Softens the effect of immediate changes in velocity and direction, making the motion of the motor less jerky. Can cause a small delay in following the control signal.	DIP switch SW11

Microstepping

The microstep resolution is set by the SW1, SW2, SW3, and SW4 switches. There are 16 settings.

Please refer to the table below and set the switches for the resolution you want.

STP-DRVAC-24025 Microstep Table				
MicroStep	Switch 1	Switch 2	Switch 3	Switch 4
200	ON	ON	ON	ON
400	OFF	ON	ON	ON
800	ON	OFF	ON	ON
1600	OFF	OFF	ON	ON
3200	ON	ON	OFF	ON
6400	OFF	ON	OFF	ON
12800	ON	OFF	OFF	ON
25600	OFF	OFF	OFF	ON
1000	ON	ON	ON	OFF
2000	OFF	ON	ON	OFF
4000	ON	OFF	ON	OFF
5000	OFF	OFF	ON	OFF
6000	ON	ON	OFF	OFF
8000	OFF	ON	OFF	OFF
10000	ON	OFF	OFF	OFF
20000	OFF	OFF	OFF	OFF

Setting Running Current

Before you turn on the power supply the first time, you need to set the drive for the proper motor running current. The rated current is usually printed on the motor label. The SureStep drive current is easy to set using the table below:

STP-DRVAC-24025 Running Current Table			
Peak A	Switch 5	Switch 6	Switch 7
0.6	ON	ON	ON
0.8	OFF	ON	ON
1.0	ON	OFF	ON
1.2	OFF	OFF	ON
1.6	ON	ON	OFF
1.8	OFF	ON	OFF
2.0	ON	OFF	OFF
2.5	OFF	OFF	OFF

Idle Current Reduction

Your drive is equipped with a feature that automatically reduces the motor current by 50% anytime the motor is not moving. This reduces drive heating by about 50% and lowers motor heating by 75%. This feature can be disabled if desired so that full current is maintained at all times. This is useful when a high holding torque is required. To minimize motor and drive heating we highly recommend that you enable the idle current reduction feature unless your application strictly forbids it.

Idle current reduction is enabled by flipping switch SW8 toward the ON position, as shown in the sketch at right. Flipping the switch to the OFF position disables the reduction feature.

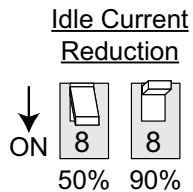

Step Noise Filter

Filters out unwanted noise that can cause extra steps. Set the switch SW9 to the ON position to set filter frequency to 150kHz. Set the switch to the OFF position to set the filter frequency to 2MHz.

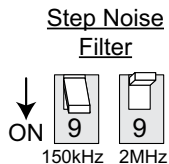

Load Inertia

Step motor systems have a tendency to resonate at certain speeds. The load inertia setting applies damping to the control algorithm. This greatly improves midrange stability, allows higher speeds and greater torque utilization, and improves settling times.

Load inertia is set to the 0-4x setting by flipping switch SW10 to the ON position, or 5-10x inertia by flipping the switch to the OFF position.

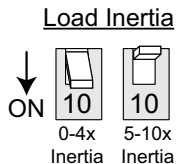

Smoothing Filter

The Step Smoothing Filter setting is effective only in the Step (Pulse) & Direction mode. It includes command signal smoothing and microstep emulation to soften the effect of immediate changes in velocity and direction, therefore making the motion of the motor less jerky. An added advantage is that it can reduce the wear on mechanical components.

The smoothing filter is enabled when switch SW11 is in the ON position, and disabled when the switch is in the OFF position.

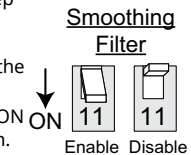

NOTE: The power must be cycled each time the position of switch 9 or switch 11 is changed.

Self Test





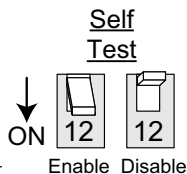















The SureStep drive includes a self test feature. This is used for trouble shooting. If you are unsure about the motor or signal connections to the drive, or if the SureStep drive isn't responding to your step pulses, you can turn on the self test.

To activate the self test, flip switch SW12 to the ON position. The drive will slowly rotate the motor, 1/2 revolution forward, then 1/2 rev backward. The pattern repeats until you flip the switch to the OFF position. The SureStep drive always uses half step mode during the self test. The self test ignores the STEP and DIRECTION inputs while operating. The ENABLE input continues to function normally.



Alarm Codes

In the event of a drive fault or alarm, the green LED will flash one or two times, followed by a series of red flashes. The pattern repeats until the alarm is cleared.

STP-DRVAC-xxxx Alarm Codes		
Alarm Code	LED Sequence	Alarm Description
SG	 Solid green	No alarm, motor disabled
FG	 Fast green	Factory use
01	 Flashing green	No alarm, motor enabled
10	 Flashing red	Configuration or memory error ¹
11	 1 red, 1 green	Motor stall (optional encoder only) ⁴
12	 1 red, 2 green	Move attempted while drive disabled
21	 2 red, 1 green	CCW limit
22	 2 red, 2 green	CW limit
31	 3 red, 1 green	Drive overheating
32	 3 red, 2 green	Internal voltage out of range ²
33	 3 red, 3 green	Factory use
41	 4 red, 1 green	Power supply overvoltage ²
42	 4 red, 2 green	Power supply undervoltage
43	 4 red, 3 green	Flash memory backup error
51	 5 red, 1 green	Over current / short circuit ^{2, 3}
52	 5 red, 2 green	Excess regeneration
61	 6 red, 1 green	Open motor winding ²
62	 6 red, 2 green	Bad encoder signal (optional encoder only) ⁴
71	 7 red, 1 green	Serial communication error ⁵
72	 7 red, 2 green	Flash memory error

¹ - Does not disable the motor.
 The alarm will clear about 30 seconds after the fault is corrected.
² - Disables the motor. Cannot be cleared until power is cycled.
³ - The over-current/short-circuit alarm typically indicates that an electrical fault exists somewhere in the system external to the drive. This alarm does not serve as motor overload protection.
⁴ - This alarm only occurs on STP-MTRD advanced integrated motor/drives
⁵ - This alarm only occurs on drives with serial communication.

Alarm Code Definitions

Alarm Code	Error	Description	Corrective Action
SG	No alarm, motor disabled	No faults active, Circuit is closed between EN+ and EN-.	N/A
01	No alarm, motor enabled	No faults active, Circuit is open between EN+ and EN-.	N/A
10	Configuration or memory error	Memory error detected when trying to load config from flash on powerup.	Restart device. No fix if restart doesn't work. Return to manufacturer for correction.
11	Motor stall (optional encoder only)	Motor torque demand exceeded capability and the motor skipped steps. This is configured in SureMotion Pro.	Increase torque utilization if it's not already maxed out, otherwise decrease the torque demand by modifying the move profile, or put in a larger motor.
12	Move attempted while drive disabled	Drive is disabled and move attempted.	Reset alarm, enable motor, and move again.
21	CCW limit	CCW limit is reached. The digital input that has been assigned CCW limit has been activated.	Unblock the CCW sensor (open the circuit) or redefine the input with SureMotion Pro.
22	CW limit	CW limit is reached. The digital input that has been assigned CW limit has been activated.	Unblock the CCW sensor (open the circuit) or redefine the input with SureMotion Pro.
31	Drive overheating	The drive's internal temperature is too high.	If the drive is operating within its standard range (input voltage and output current are OK), more heat must be removed from the drive during operation. For Advanced drives (see "Mounting the Drive" on page 4-14), ensure the drive is mounted to a metal surface that can dissipate the drive's heat. For Integrated motor/drives, see "Mounting" on page 5-13. For both types of drives: If the mounting surface cannot pull enough heat away from the drive, forced airflow (from a fan) may be required to cool the drive.
32	Internal voltage out of range	Gate voltage, 5V rail, or 3V rail are out of spec.	Ensure adequate supply voltage (in very rare cases, low input voltages combined with fast accelerations can draw down the gate voltage) and try again. If persistent, RMA is required.
41	Power supply overvoltage	The AC voltage feeding the drive is above the allowable level.	Limit the input voltage to the drive to 145VAC if the voltage switch is set for 115V. If the voltage switch is set for 230V, limit the input voltage to 295VAC.
42	Power supply undervoltage	The AC voltage feeding the drive is below the allowable level.	Ensure the input voltage to the drive is at least 75VAC if the voltage switch is set for 115V. If the voltage switch is set for 230V, ensure the input voltage is at least 135VAC.

Alarm Code	Error	Description	Corrective Action
43	Flash memory backup error	Memory error detected when trying to load config from flash on powerup.	Restart device. No fix if restart doesn't work. Return to manufacturer for correction.
51	Over current / short circuit	Motor leads shorted - only checked on powerup.	Check and fix motor wiring.
52	Excess regen	Too much regenerative energy is being fed from the motor back into the drive.	Excess Regen typically occurs when a motor is being pushed by load (overhauling load) or the motor is trying to decelerate the load too quickly. Reduce the backdriving force, lengthen the deceleration ramp, or increase the size of the motor.
61	Open motor winding	Motor leads not connected - only checked on powerup.	Check and fix motor wiring.
62	Bad encoder signal (optional encoder only)	Noisy or otherwise incorrectly formatted encoder signal (lack of A or B, lack of differential signal).	Check encoder wiring, always use differential encoders (or use checkbox in SureMotion Pro to disable this error when using single ended).
71	Serial communication error	Catch-all error for something wrong with serial communications. See CE command in HCR for details.	If drive can communicate, CE can give a precise diagnosis. If not, refer to the Serial Communications part of the HCR for troubleshooting.
72	Flash memory error	Memory error detected when trying to load config from flash on powerup.	Restart device. No fix if restart doesn't work. Return to manufacturer for correction.

SURESTEP™
INTEGRATED
MOTORS/DRIVES



CHAPTER
6

In This Chapter...

Features	6-3
General Features:	6-3
Standard Drive Features	6-3
Advanced Drive Features	6-3
Features Comparison.....	6-4
Specifications	6-5
Getting Started	6-11
Installing Software	6-11
Mounting.....	6-11
Additional Reading.....	6-12
Mating Connectors and Accessories.....	6-12
Using a Regulated Power Supply	6-17
LED Error Codes	6-18
STP-MTRD Inputs and Outputs	6-22
Input/Output Functions	6-25
The Step (STEP) and Direction (DIR) Inputs.....	6-26
The Enable (EN/IN3) Digital Input.....	6-28
The Analog (AIN) Input.....	6-29
The Digital Output	6-30
Using the Optional Encoder	6-31
Configuring the Standard STP-MTRD.....	6-32
Drive/Motor Heating.....	6-37
Torque Speed Graphs	6-40

Dimensions and Mounting Slot Locations 6-43

Features

General Features:

- NEMA 17, NEMA 23, and NEMA 24 frame sizes available
- DC power supply required: 12-48 VDC or 12-70 VDC
- Pulse/Direction or CW Pulse/CCW Pulse
- Digital input filtering
- Three optically isolated digital inputs, 5 to 24 volts
- One isolated digital input, 30V 100mA
- Step input signal smoothing (microstep emulation), performs high resolution stepping by synthesizing coarse steps into fine microsteps
- Dynamic smoothing, software configurable filtering for use in removing spectral components from command sequence, reduces jerk, limiting excitation of system resonance
- Anti-resonance (electronic damping): raises the system-damping ratio to eliminate midrange instability and allow stable operation throughout the speed range of the motor
- Idle current reduction range of 0-90% of running current after a delay selectable in milliseconds
- Configurable hardware digital noise filter, software noise filter
- Non-volatile storage, configurations are saved in FLASH memory on-board the DSP
- Dynamic current control, software configurable for running current, accel current, idle current, to make motion smoother and the motor run cooler



Standard Drive Features

- Optional, external encoder feedback
Note: Please see Appendix A for more encoder output options
- Configurable via DIP switches
- Available torque from 60 oz-in to 210 oz-in

Advanced Drive Features

- AB Quadrature/Encoder Following
- Velocity (Oscillator) and position mode
- Streaming SCL commands
- RS-485 communications
- Optional, internal encoder feedback. Internal only (not customer accessible)
- Four "Variable I/O" points, 5 to 24 volts (available on NEMA 24 only)
- 12-bit analog input for speed and position, 0 to 5 VDC
- Configurable via SureMotion Pro software
- Available torque from 68 oz-in to 340 oz-in

Features Comparison

Features Comparison – Integrated Motor/Drives					
Motor/Drive Series	STP-MTRD-17xxxxR(E)	STP-MTRD-23xxxxR(E)	STP-MTRD-24xxxxRV(E)	STP-MTRD-17xxxx(E)	STP-MTRD-23xxxx(E)
Motor/Drive Type	Advanced (w/RS-485 Serial/ASCII)			Standard (Pulse/Direction only)	
DC Power Supply	12-48 VDC	12-70 VDC	12-70 VDC	12-48 VDC	12-70 VDC
Pulse/Direction or CW Pulse/CCW Pulse	✓	✓	✓	✓	✓
AB Quadrature/Encoder Following	✓	✓	✓	-	-
Velocity (Oscillator) and Position Mode	✓	✓	✓	-	-
Serial ASCII (SCL) Commands	✓	✓	✓	-	-
RS-485 ASCII Communications	✓	✓	✓	-	-
Optional, Internal Encoder Feedback (Position Verification)	✓	✓	✓	-	-
Optional, External Encoder Feedback (Open Loop)	-	-	-	✓	✓
Available Torque	Up to 68 oz-in	Up to 210 oz-in	Up to 340 oz-in	Up to 68 oz-in	Up to 210 oz-in
Digital Input Filtering	✓	✓	✓	✓	✓
Three Optically Isolated Digital Inputs, 5-24 Volts	✓	✓	-	✓	✓
One Optically Isolated Digital Output, 30V 100mA	✓	✓	-	✓	✓
Four, 5-24 Volt digital “Variable I/O” points	-	-	✓	-	-
12-bit Analog Input	✓	✓	✓	-	-
Step Input Signal Smoothing (Microstep Emulation)	✓	✓	✓	✓	✓
Anti-resonance	✓	✓	✓	✓	✓
Electronic Damping	✓	✓	✓	✓	✓
Idle Current Reduction	✓	✓	✓	✓	✓
Configuration Method	SureMotion Pro software			Dip Switch	

Specifications

General Specifications – All Integrated Motor/Drives	
Drive Cooling Method	Natural convection (mount to suitable heat sink)
Step Resolution	Full, Half, Microstepping, Microstep Emulation
Step Angle	1.8 degrees
Shaft Runout	NEMA 17: 0.03 mm NEMA 23/24 : 0.05 mm
Max Shaft Radial Play @ 1lb load	0.02 mm
Perpendicularity	0.08 mm
Concentricity	0.05 mm
Maximum Radial Load	NEMA 17: 6.7 lb. NEMA 23/24: 13.9 lb.
Maximum Axial (Thrust) Load	NEMA 17: 34 lb. NEMA 23/24: 63 lb.
Supply Output	+4.8 - 5 volts @ 50mA maximum (Note: Not applicable to Pulse and Direction MTRD drives, only for advanced MTRD drives)
Circuit Protection	Short circuit, over-voltage, under-voltage, over-temp
Operating Temperature	0-85°C (32-185°F) 0-70°C (0-158°F) for NEMA 24 systems
Ambient Temperature	0-40°C (32-104°F)
Over-temp Shutdown	85°C (185°F)
Humidity	90% max, non-condensing
Insulation Class	Class B (130°C)
Environmental Rating	IP40
Product Material	Aluminum/steel/plastic case, stainless steel shaft
Agency Approvals	CE*

*For NEMA 24 motors, an EMI filter (RES10F06) is needed on the power supply for CE compliance.

SureStep™ Standard Integrated Motor/Drive Specifications			
Integrated Motor/Drive	STP-MTRD-17038 / STP-MTRD-17038E	STP-MTRD-23042 / STP-MTRD-23042E	STP-MTRD-23065 / STP-MTRD-23065E
Frame Size	NEMA 17	NEMA 23	
Input Power	12-48 VDC (nominal) (Range: 11-52 VDC) (fuse at V+)	12-70 VDC (nominal) (Range: 11-74 VDC) (fuse at V+)	
Current Controller	Digital MOSFET, PWM at 16kHz		
Encoder Feedback	“E” models only. External encoder must be wired to external feedback device.		
Configuration Method	Dip Switches		
Input Signals	Step	5-24 VDC nominal (range 4-30VDC); (5mA @ 4V; 15 mA @ 30V); Optically isolated. Minimum pulse width = 3µs (at 2 MHz), 0.25µs (at 150kHz) Maximum pulse frequency = 150kHz or 2MHz (switch selectable) Function = Step Input, Limit CW	
	Direction	5-24 VDC nominal (range 4-30VDC); (5mA @ 4V; 15 mA @ 30V); Optically isolated. Minimum pulse width = 3µs (at 2 MHz), 0.25µs (at 150kHz) Maximum pulse frequency = 150kHz or 2MHz (switch selectable) Function = Direction Input, Limit CCW	
	Enable	5-24 VDC nominal (range 4-30VDC); (5mA @ 4V; 15 mA @ 30V); Optically isolated. Minimum pulse width = 3µs (at 2 MHz), 0.25µs (at 150kHz) Maximum pulse frequency = 150kHz or 2MHz (switch selectable) Function = Enable Input	
Output Signal	Output	30 VDC / 100mA max, photodarlington, voltage drop = 1.2V max at 100mA Function = Alarm Output	
DIP Switch Selectable Functions	Step Pulse Type	Step and Direction: Step signal = step/pulse; Direction signal = direction. Step CW & CCW: Step signal = CW step; Direction signal = CCW step.	
	Step Pulse Noise Filter	Selectable 150 kHz or 2MHz	
	Current Reduction	This is the percentage of full current that the motor will use when the shaft is rotating. 100%, 90%, 70%, and 50% current selections.	
	Idle Current Reduction	Reduce power consumption and heat generation by limiting motor idle current to 90% or 50% of running current. (Holding torque is reduced by the same %.)	
	Load Inertia	Anti-resonance and damping feature improves motor performance. Set motor and load inertia range to 0-4x or 5-10x.	
	Step Resolution	200-25600 (dip switch selectable)	
	Self Test	Automatically rotate the motor back and forth two turns in each direction in order to confirm that the motor is operational.	
Max Holding Torque	4.25 lb-in / 68 oz-in / 0.480189 N·m	7.8125 lb-in / 125 oz-in / 0.8827 N·m	13.125 lb-in / 210 oz-in / 1.482936 N·m
Mounting	Four M3 screws	Four #6 screws	
Removable Connector	Control	Housing: Tyco 4-643498-1 Cover: Tyco 1-643075-1	Connector part number: Weidmuller 1610200000, included in STP-CON-3
	Encoder	Two 5 pin inserts (Molex# 14-60-0058), one housing Molex# 15-04-5104	
Rotor Inertia	0.448 oz-in ² (0.082 kg·cm ²)	1.420 oz-in ² (0.260 kg·cm ²)	2.515 oz-in ² (0.460 kg·cm ²)
Status LEDs	1 red/green		
Weight	14.7 oz	30 oz (850g)	42 oz (1200g)

SureStep™ Advanced Integrated Motor/Drive Specifications			
Integrated Motor/Drive	STP-MTRD-17030R / STP-MTRD-17030RE	STP-MTRD-17038R / STP-MTRD-17038RE	
Frame Size	NEMA 17		
Input Power	12-48 VDC (nominal) (Range: 11-52 VDC) (fuse at V+)		
Current Controller	Dual H-Bridge, 4 Quadrant, 4 state PWM @ 16kHz		
Encoder Feedback	"E" models only. Encoder is internal and provides position verification and stall prevention control by default. Internal only (not customer accessible).		
Configuration Method	SureMotion Pro software (SM-PRO: Free download)		
Input Signals	Step/Pulse	5-24 VDC nominal. Optically isolated. Minimum pulse width = 250ns (at 3 MHz). Maximum pulse frequency = 3MHz, max current draw = 12mA Function = Step Input, Jog CW, Limit CW, Start/Stop, General Purpose	
	Direction	5-24 VDC nominal. Optically isolated. Minimum pulse width = 250ns (at 3 MHz). Maximum pulse frequency = 3MHz, max current draw = 12mA Function = Direction Input, Jog CCW, Limit CCW, General Purpose	
	Enable	5-24 VDC nominal. Optically isolated. Minimum pulse width = 50µs, maximum pulse frequency = 10kHz, max current draw = 12mA Function = Enable Input, Reset Input, Change Speed, General Purpose	
	Analog	0-5 VDC nominal (AIN referenced to GND). Input impedance: 30K ohms minimum, resolution = 12 bits Function = analog control modes and general purpose analog usage; programmable for signal range, offset, dead band, and filtering	
Output Signal	30VDC, 40mA maximum. Optically isolated, open collector. Maximum pulse frequency 10kHz. Functions = Brake Output, Alarm Output, Motion Output, Tach Output, General Purpose		
Communication Interface	RS-485 ASCII/SCL (2- or 4-wire network for PLC control; SureMotion Pro software requires 4-wire)		
Non-volatile Memory Storage	Configurations are saved in FLASH memory on-board the DSP		
Features	Current Reduction	Selectable in SureMotion Pro software	
	Idle Current Reduction	Reduction range of 0-90% of running current after delay selectable in ms	
	Microstep Resolution	Software selectable from 200 to 51200 steps/rev in increments of 2 steps/rev	
	Modes of Operation	Pulse (step) & direction, CW/CCW, A/B quadrature, velocity (oscillator), SCL streaming commands via RS-485 ASCII/SCL (2- or 4-wire)	
	Self Test	Checks internal and external power supply voltages, diagnoses open motor phases	
Max Holding Torque	3.375 lb-in / 54 oz-in / 0.381326 N-m	4.25 lb-in / 68 oz-in / 0.480189 N-m	
Mounting	Four M3 screws		
Removable Connector (included in STP-CON-3)	DC Power	2-position screw terminal: Dinkle 0225-1602L (new models) or Weidmuller 1615780000 (old models)	
	I/O	11-position spring cage: Phoenix 1881419	
	Comm	5-position spring cage: Phoenix 1881354	
Rotor Inertia	0.310 oz-in ² (0.057 kg-cm ²)	0.448 oz-in ² (0.082 kg-cm ²)	
Status LEDs	1 red, 1 green		
Weight	12.7 oz (360g)	15.6 oz (441g)	

SureStep™ Advanced Integrated Motor/Drive Specifications		
Integrated Motor/Drive	STP-MTRD-23042R / STP-MTRD-23042RE	STP-MTRD-23065R / STP-MTRD-23065RE
Frame Size	NEMA 23	
Input Power	12-70 VDC (nominal) (Range: 11-74 VDC) (fuse at V+)	
Current Controller	Dual H-Bridge, 4 Quadrant, 4 state PWM @ 20kHz	
Encoder Feedback	"E" models only. Encoder is internal and provides closed loop control by default. Internal only (not customer accessible).	
Configuration Method	SureMotion Pro software (SM-PRO: Free download)	
Input Signals	Step/Pulse	5-24 VDC nominal. Optically isolated. Minimum pulse width = 250ns (at 2 MHz). Maximum pulse frequency = 2MHz, max current draw = 12mA Function = Step Input, Jog CW, Limit CW, Start/Stop, General Purpose
	Direction	5-24 VDC nominal. Optically isolated. Minimum pulse width = 250ns (at 2 MHz). Maximum pulse frequency = 2MHz, max current draw = 12mA Function = Direction Input, Jog CCW, Limit CCW, General Purpose
	Enable	5-24 VDC nominal. Optically isolated. Minimum pulse width = 50µs, maximum pulse frequency = 10kHz, max current draw = 12mA Function = Enable Input, Reset Input, Change Speed, General Purpose
	Analog	0-5 VDC nominal (AIN referenced to GND). Input impedance: 30K ohms minimum, resolution = 12 bits Function = analog control modes and general purpose analog usage; programmable for signal range, offset, dead band, and filtering
Output Signal	30VDC, 40mA maximum. Optically isolated, open collector. Maximum pulse frequency 10kHz. Functions = Brake Output, Alarm Output, Motion Output, Tach Output, General Purpose	
Communication Interface	RS-485 ASCII/SCL (2- or 4-wire network for PLC control; SureMotion Pro software requires 4-wire)	
Non-volatile Memory Storage	Configurations are saved in FLASH memory on-board the DSP	
Features	Current Reduction	Selectable in SureMotion Pro software
	Idle Current Reduction	Reduction range of 0-90% of running current after delay selectable in ms
	Microstep Resolution	Software selectable from 200 to 51200 steps/rev in increments of 2 steps/rev
	Modes of Operation	Pulse (step) & direction, CW/CCW, A/B quadrature, velocity (oscillator), SCL streaming commands
	Self Test	Checks internal and external power supply voltages. Diagnoses open motor phases and motor resistance changes > 40%
Max Holding Torque	7.8125 lb-in / 125 oz-in / 0.8827 N·m	13.125 lb-in / 210 oz-in / 1.482936 N·m
Mounting	Four #6 screws	
Removable Connector (included in STP-CON-3)	DC Power	2-position screw terminal: Weidmuller 1615780000
	I/O	11-position spring cage: Phoenix 1881419
	Comm	5-position spring cage: Phoenix 1881354
Rotor Inertia	1.420 oz-in ² (0.260 kg-cm ²)	2.515 oz-in ² (0.460 kg-cm ²)
Status LEDs	1 red, 1 green	
Weight	30 oz (850g)	42 oz (1191g)

SureStep™ Advanced Integrated Motor/Drive Specifications		
Integrated Motor/Drive	STP-MTRD-24075RV / STP-MTRD-24075RVE	
Frame Size	NEMA 24	
Input Power	12-70* VDC (nominal) (Range: 11-74 VDC) (fuse at V+)	
Current Controller	Dual H-Bridge, 4 Quadrant, 4 state PWM @ 20kHz	
Encoder Feedback	"E" models only. Encoder is internal and provides position verification and stall prevention control by default. Internal only (not customer accessible).	
Configuration Method	SureMotion Pro software (SM-PRO: free download)	
Variable I/O	I/O 1 (Step/Pulse)	INPUT: 5-24 VDC nominal. Optically isolated. Minimum pulse width = 250ns (at 3MHz). Maximum pulse frequency = 3MHz, max current draw = 12mA, Function = Step Input, Jog CW, Enable Input, Start/Stop, General Purpose OUTPUT: 30VDC, 40mA maximum. Optically isolated, open collector. Maximum pulse frequency 10kHz. Functions = Brake Output, Fault Output, Motion Output, Tach Output, General Purpose
	I/O 2 (Direction)	INPUT: 5-24 VDC nominal. Optically isolated. Minimum pulse width = 250ns (at 3MHz). Maximum pulse frequency = 3MHz, max current draw = 12mA, Function = Direction Input, Jog CCW, Alarm Reset Input, General Purpose OUTPUT: 30VDC, 40mA maximum. Optically isolated, open collector. Maximum pulse frequency 10kHz. Functions = Brake Output, Fault Output, Motion Output, Tach Output, General Purpose
	I/O 3	INPUT: 5-24 VDC nominal. Optically isolated. Minimum pulse width = 250ns (at 3MHz). Maximum pulse frequency = 3MHz, max current draw = 12mA, Function = Limit CW Input, Enable Input, Change Speed Input, General Purpose OUTPUT: 30VDC, 40mA maximum. Optically isolated, open collector. Maximum pulse frequency 10kHz. Functions = Brake Output, Fault Output, Motion Output, Tach Output, General Purpose
	I/O 4	INPUT: 5-24 VDC nominal. Optically isolated. Minimum pulse width = 250ns (at 2 MHz). Maximum pulse frequency = 2MHz, max current draw = 12mA, Function = Limit CCW Input, Alarm Reset Input, General Purpose OUTPUT: 30VDC, 40mA maximum. Optically isolated, open collector. Maximum pulse frequency 10kHz. Functions = Brake Output, Fault Output, Motion Output, Tach Output, General Purpose
Analog	0-5 VDC nominal (AIN referenced to GND). Input impedance: 30K ohms minimum, resolution = 12 bits, Function = analog control modes and general purpose analog usage; programmable for signal range, offset, dead band, and filtering	
Communication Interface	RS-485 ASCII/SCL (2- or 4-wire network for PLC control; SureMotion Pro software requires 4-wire)	
Features	Current Reduction	Selectable in SureMotion Pro software
	Idle Current Reduction	Reduction range of 0-90% of running current after delay selectable in ms
	Microstep Resolution	Software selectable from 200 to 51200 steps/rev in increments of 2 steps/rev
	Modes of Operation	Pulse (step) & direction, CW/CCW, A/B quadrature, velocity (oscillator), SCL streaming commands
	Self Test	Checks internal and external power supply voltages. Diagnoses open motor phases and motor resistance changes > 40%.
* If using the STP-PWR-7005, the power supply (when unloaded) may float above the drive's maximum allowable DC voltage if the power supply is fed with greater than 120VAC input. Either ensure that the incoming AC voltage is less than 120V or supply a burden resistor to pull the unloaded DC voltage level down.		

<i>SureStep™ Advanced Integrated Motor/Drive Specifications (continued)</i>		
Integrated Motor/Drive	STP-MTRD-24075RV / STP-MTRD-24075RVE	
Max Holding Torque	21.25 lb-in / 340 oz-in / 2.400944 N-m	
Mounting	Four #6 screws	
Removable Connector (included in STP-CON-3)	DC Power	2-position screw terminal: Dinkle 0225-1602L (new models) or Weidmuller 1615780000 (old models)
	I/O	11-position spring cage: Phoenix 1881419
	Comm	5-position spring cage: Phoenix 1881354
Rotor Inertia	4.900 oz-in ² (0.897 kg-cm ²)	
Status LEDs	1 red, 1 green	
Weight	56 oz (1580g)	

Getting Started

The following items are needed for the Standard and Advanced integrated motors/drives (STP-MTRD):

- DC power supply (see the Chapter 8, “Choosing a Power Supply”) for help in choosing one.
- A small, flat blade screwdriver for inserting wires into the connector.
- A source of step signals, such as a PLC or motion controller.

Additional items needed for Advanced integrated motors/drives (STP-MTRD-xxxxR):

- A PC running Microsoft Windows software.
- A configuration cable and suitable USB to four wire RS-485 converter. ADC part numbers STP-USB485-4W and STP-485DB9-CLB-2 are recommended.

Installing Software

Before using the STP-MTRD-xxxxR Advanced integrated motor and SureMotion Pro software in an application, the following steps are necessary:

- Install the SureMotion Pro software.
- Launch the software by clicking Programs -> AutomationDirect -> SureMotion Pro
- Connect the drive to the PC using the programming cable. STP-USB485-4W in 4-wire configuration is recommended (see “Chapter 9: Communications” for detailed info).
- Connect the drive to the power supply.
- Apply power to the drive. (When first powered-up, the drive sends out a “power-up packet” to identify itself. See the SCL Manual for more details.)
- The software will recognize the drive and display the model and firmware version. At this point, it is ready for use.

Mounting

As with any step motor, the STP-MTRD must be mounted so as to provide maximum heat sinking and airflow. Keep enough space around the unit to allow for airflow.



Never use the drive where there is no airflow or where other devices cause the surrounding air to be more than 40°C (104°F). Never put the drive where it can get wet. Never use the drive where metal or other electrically conductive particles can infiltrate the drive. Always provide airflow around the STP-MTRD.

Use the following to mount the motors:

- STP-MTRD-17 series: four M3 screws
- STP-MTRD-23 and -24 series: four #6 or #8 screws

Additional Reading

To learn more about SureMotion Pro™, please refer to the software's built-in help.

To learn more about the SCL language, please read the Serial Command Language User Manual.

Mating Connectors and Accessories

Advanced Drive Mating Connectors & Accessories			
Mating Connector (Type)	Part Number	Terminal Tightening Torque	Acceptable Wire AWG
DC Power (new models) (2-position, spring cage)	Dinkle 0225-1602L	N/A	16-20 AWG, no ferrules allowed
DC Power (old models) (2-position, screw terminal)	Weidmuller 1615780000	0.25 Nm	16-20 AWG, ferrules allowed
I/O (11-position, spring cage)	Phoenix 1881419	N/A	20-22 AWG, no ferrules allowed
Comm (5-position, spring cage)	Phoenix 1881354		

Note: ADC's STP-CON-3 connector kit contains all three above parts.

Standard Drive Mating Connectors & Accessories			
Mating Connector (Type)	Part Number	Terminal Tightening Torque	Acceptable Wire AWG
NEMA 17: 11-pin insulation displacement style connector	Housing: Tyco 4-643498-1 Cover: Tyco 1643075-1	N/A	22 AWG
NEMA 23: 11-pin screw terminal connector	Weidmuller 1610200000	0.25 Nm	18-20 AWG, ferrules allowed

Note: See STP-CON-3 connector kit and STP-CBL-CAXx for replacement options.

General Accessories	
Part	Part Number
USB to RS485 Adapter	STP-USB485-4W
Regeneration Clamp and/or breaking resistor for applications with high inertial loads	STP-DRVA-RC-050 STP-DRVA-BR-100
SureStep communication cable, 9-pin	STP-485DB9-CBL-2
Replacement SureStep incremental (quadrature) encoder for standard models	STP-MTRA-ENC1

Note: Multiple replacement encoder options are available in Appendix A.

Installation and Connections

STP-MTRD-17 Standard Series

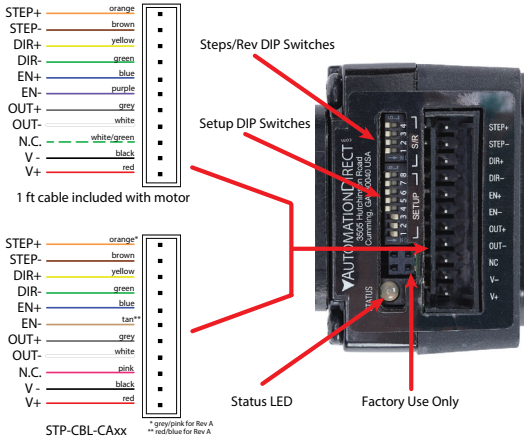

Includes a 12 inch control cable for accessing the terminals. STP-CBL-CAxx cable can be purchased separately if longer cable lengths are needed.

STP-MTRD-23 Standard Series

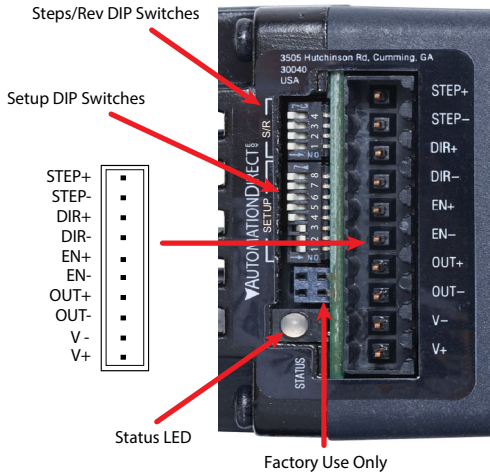

STP-MTRD-17 / STP-MTRD-23 Advanced Series

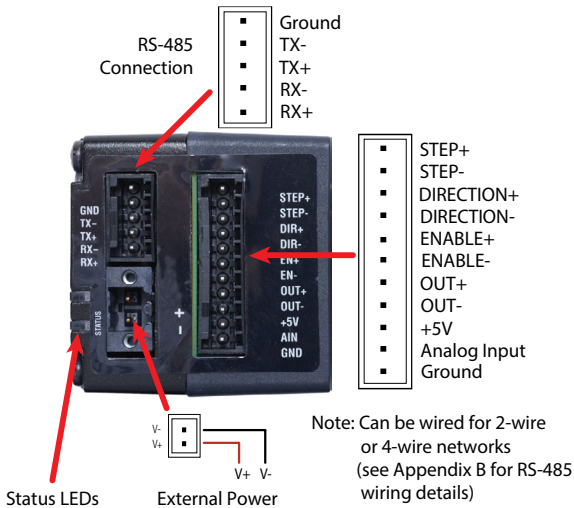

STP-MTRD-24 Advanced Series

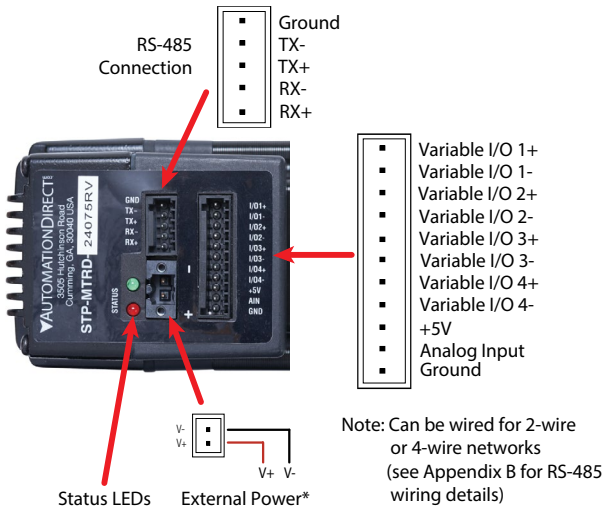

* an EMI filter (RES10F03) is needed on the power supply for CE compliance

Connecting a Power Supply to the Standard STP-MTRD-17

For information on choosing a power supply, please see the “Choosing a Power Supply” section of Chapter 7, “SureStep System Power Supplies.”

Connect the power supply “+” terminal to connector terminal V+, then connect power supply “-” to connector terminal V-. Use 22 gauge stranded wire if supplying your own connector and cable.

The STP-MTRD-17 contains an internal fuse that connects to the power supply + terminal. This fuse is not user replaceable. If you want to install a user serviceable fuse in your system, install a fast acting 2 amp fuse in line with the + power supply lead.

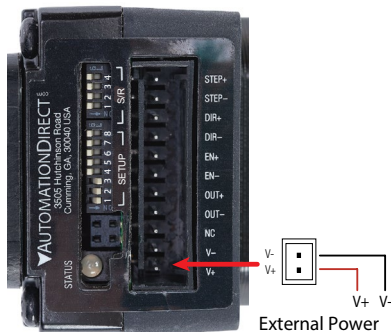

Be careful not to reverse the wires. Reverse connection will open the internal fuse on your drive and void your warranty. Fuse is not user-replaceable.

Connecting a Power Supply to the Standard STP-MTRD-23

For information on choosing a power supply, please see the “Choosing a Power Supply” section of Chapter 7, “SureStep System Power Supplies.”

Connect the power supply “+” terminal to the connector terminal labeled “V+”, then connect the power supply “-” to the connector terminal labeled “V-”. Use 14-20 gauge stranded wire.

The STP-MTRD-23 contains an internal fuse that connects to the power supply + terminal. This fuse is not user replaceable. If you want to install a user serviceable fuse in your system, install a fast acting 4 amp fuse in line with the + power supply lead.

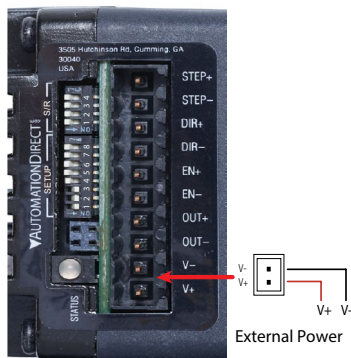

Be careful not to reverse the wires. Reverse connection will open the internal fuse on your drive and void your warranty. Fuse is not user-replaceable.

Connecting a Power Supply to the Advanced STP-MTRD-xxxxxR

For information on choosing a power supply, please see the “Choosing a Power Supply” section of Chapter 7, “SureStep System Power Supplies.”

Connect the power supply “+” terminal to the drive “+” terminal and the power supply “-” terminal to the drive “-” terminal using 16 to 22 gauge wire. The STP-MTRD contains an internal fuse connected to the “+” terminal. This fuse is not user replaceable. If a user serviceable fuse is desired, install a fast acting fuse in line with the “+” power supply lead.

Suitable fuses are:

- STP-MTRD-17 series: 2 amp
- STP-MTRD-23 series: 4 amp
- STP-MTRD-24 series: 5 amp

It is important that the motor frame be electrically connected to ground. When the motor is mounted on an insulated surface, a ground wire is required. Also, in applications where multiple integrated motors are used on a machine, individual ground wires may reduce the overall electrical noise level.

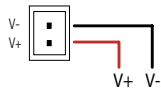

External Power





















Be careful not to reverse the wires. Reverse connection will open the internal fuse on your drive and void your warranty. Fuse is not user-replaceable.



To maintain CE compliance with the STP-MTRD-24, EMI filter RES10F06 must be wired in series with the V+ power supply to the motor/drive.

LED Error Codes

STP-MTRD Alarm Codes		
Alarm Code	LED Sequence	Alarm Description
SG	 Solid green	No alarm, motor disabled
FG	 Fast green	Factory use
01	 Flashing green	No alarm, motor enabled
10	 Flashing red	Configuration or memory error ¹
11	 1 red, 1 green	Motor stall (optional encoder only) ⁴
12	 1 red, 2 green	Move attempted while drive disabled
21	 2 red, 1 green	CCW limit
22	 2 red, 2 green	CW limit
31	 3 red, 1 green	Drive overheating
32	 3 red, 2 green	Internal voltage out of range ²
33	 3 red, 3 green	Factory use
41	 4 red, 1 green	Power supply overvoltage ²
42	 4 red, 2 green	Power supply undervoltage
43	 4 red, 3 green	Flash memory backup error
51	 5 red, 1 green	Over current / short circuit ^{2, 3}
61	 6 red, 1 green	Open motor winding ²
62	 6 red, 2 green	Bad encoder signal (optional encoder only) ⁴
71	 7 red, 1 green	Serial communication error ⁵
72	 7 red, 2 green	Flash memory error

¹ - Does not disable the motor.
 The alarm will clear about 30 seconds after the fault is corrected.
² - Disables the motor. Cannot be cleared until power is cycled.
³ - The over-current/short-circuit alarm typically indicates that an electrical fault exists somewhere in the system external to the drive. This alarm does not serve as motor overload protection.
⁴ - This alarm only occurs on STP-MTRD advanced integrated motor/drives
⁵ - This alarm does not occur on STP-DRV-6575 or standard integrated motor/drives

Alarm Code Definitions

Alarm Code	Error	Description	Corrective Action
SG	No alarm, motor disabled	No faults active, Circuit is closed between EN+ and EN-.	N/A
01	No alarm, motor enabled	No faults active, Circuit is open between EN+ and EN-.	N/A
10	Configuration or memory error	Memory error detected when trying to load config from flash on powerup.	Restart device. No fix if restart doesn't work.
11	Motor stall (optional encoder only)	Motor torque demand exceeded capability and the motor skipped steps. This is configured in SureMotion Pro.	Increase torque utilization if it's not already maxed out, otherwise decrease the torque demand by modifying the move profile, or put in a larger motor.
12	Move attempted while drive disabled	Drive is disabled and move attempted.	Reset alarm, enable motor, and move again.
21	CCW limit	CCW limit is reached. The digital input that has been assigned CCW limit has been activated.	Unblock the CCW sensor (open the circuit) or redefine the input with SureMotion Pro.
22	CW limit	CW limit is reached. The digital input that has been assigned CW limit has been activated.	Unblock the CCW sensor (open the circuit) or redefine the input with SureMotion Pro.
31	Drive overheating	The drive's internal temperature is too high.	If the drive is operating within its standard range (input voltage and output current are OK), more heat must be removed from the drive during operation. For Advanced drives (see "Mounting the Drive" on page 4-14), ensure the drive is mounted to a metal surface that can dissipate the drive's heat. For Integrated motor/drives, see "Mounting" on page 5-13. For both types of drives: If the mounting surface cannot pull enough heat away from the drive, forced airflow (from a fan) may be required to cool the drive.
32	Internal voltage out of range	Gate voltage, 5V rail, or 3V rail are out of spec.	Ensure adequate supply voltage (in very rare cases, low input voltages combined with fast accelerations can draw down the gate voltage) and try again. If persistent, RMA is required.

Alarm Code	Error	Description	Corrective Action
41	Power supply overvoltage	The DC voltage feeding the drive is above the allowable level.	<p>Decrease the input voltage. Linear power supplies do not output a fixed voltage: the lighter the output current, the higher the output voltage will float. If a linear supply's voltage floats above the drive's max voltage, you can install a small power resistor across the linear power supply's output to provide some load that will help pull down the floating voltage.</p> <p>Consider using a switching power supply such as the Rhino PSB power supply series.</p> <p>Overtoltage can also be fed back into a system by regeneration (when an overhauling load pushes energy back into the motor). In an application with regen problems, install an STP-DRVA-RC-050 regen clamp to help dissipate the extra energy. (The regen clamp will not help with the floating linear power supply that floats too high, but it will help with excess voltage generated from an overhauling load.)</p>
42	Power supply undervoltage	The DC voltage feeding the drive is below the allowable level.	Correct the power supply. If this error occurs during operation, the power supply is most likely undersized. A sudden high current demand can cause an undersized power supply to dip in output voltage.
43	Flash memory backup error	Memory error detected when trying to load config from flash on powerup.	Restart device. No fix if restart doesn't work.
51	Over current / short circuit	Motor leads shorted - only checked on powerup.	Check and fix motor wiring.
61	Open motor winding	Motor leads not connected - only checked on powerup.	Check and fix motor wiring.
62	Bad encoder signal (optional encoder only)	Noisy or otherwise incorrectly formatted encoder signal (lack of A or B, lack of differential signal).	Check encoder wiring, always use differential encoders (or use checkbox in SureMotion Pro to disable this error when using single ended).
71	Serial communication error	Catch-all error for something wrong with serial communications. See CE command in HCR for details.	If drive can communicate, CE can give a precise diagnosis. If not, refer to the Serial Communications part of the HCR for troubleshooting.

Alarm Code	Error	Description	Corrective Action
72	Flash memory error	Memory error detected when trying to load config from flash on powerup.	Restart device. No fix if restart doesn't work.

STP-MTRD Inputs and Outputs

The standard drives (STP-MTRD-xxxx) have three inputs:

- STEP: a high speed digital input for step pulse commands, 5-24 volt logic
- DIR: a high speed digital input for the direction signal, 5-24 volt logic
- EN: a 5-24 volt input for commanding the removal of power from the motor



NOTE: STEP and DIR inputs can be converted to STEP CW and STEP CCW by moving switch #8 to the ON position.

The standard drives have a single digital output labeled OUT. This output closes to signal a fault condition. The output can be used to drive LEDs, relays, and the inputs of other electronic devices like PLCs. The "+" (collector) and "-" (emitter) terminals of the output are available at the connector - this allows you to configure the output for current sourcing or sinking. STP-MTRD-17038(E) includes a 12 inch control cable for accessing the terminals. STP-CBL-CAxx cable can be purchased separately if longer cable lengths are needed.

Connector Pin Diagrams

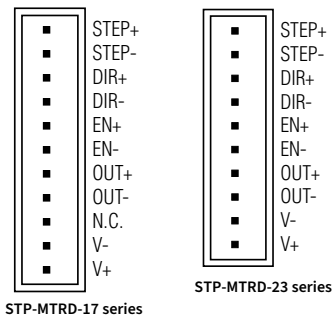

Control Cable STP-CBL-CAxx (for STP-MTRD-17038/17038E)

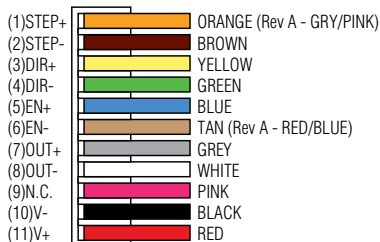

Internal Circuit Diagram

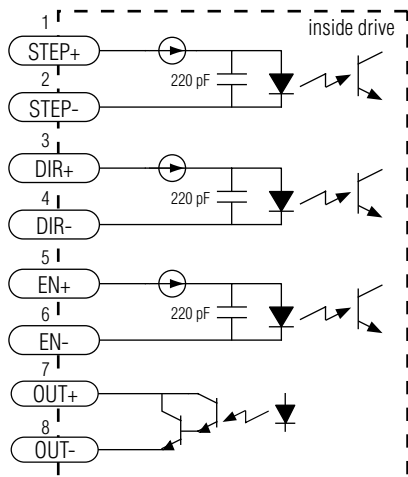

The advanced STP-MTRD-17xxxxR and -23xxxxR drives include 3 digital inputs and 1 analog input:

- Two high speed digital inputs, 5-24 volt logic, labeled STEP (or IN1) and DIR (or IN2), for commanding position. Pulse & direction, CW/CCW pulse, and A/B quadrature encoder signals can be used as position commands with these inputs. The STEP/IN1 and DIR/IN2 inputs can also be connected to sensors, switches and other devices for use with streaming SCL commands such as Wait Input, Seek Home, Feed to Sensor (FS), etc. When not being used for commanding position, these inputs can also be used for CW/CCW end-of-travel limits, CW/CCW jog inputs, or Run/stop & direction velocity-mode inputs.



NOTE: the available functionality of these inputs is determined by the STP-MTRD control option (R) as well as the motion control mode selected in SureMotion Pro.

- One digital input, 5-24 volt logic, labeled EN (or IN3), which can be used for motor enable/disable and/or alarm reset. It can also be connected to a sensor, switch or other device for use with streaming SCL commands such as Wait Input, Seek Home, Feed to Sensor, etc.
- One analog input, 0-5 volt logic, labeled AIN, which can be used as an analog velocity or position command. It can also be used with streaming SCL commands such as Wait Input, Seek Home, Feed to Sensor, etc.



NOTE: On the advanced drives, the green 5 and 11 position spring clip terminal blocks do not accept ferrules, either use bare stranded copper or tinned leads.

• Connector Pin Diagram

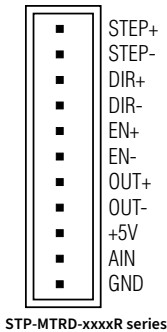

I/O Connector

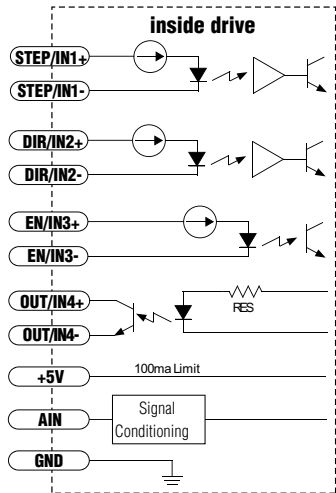

STP-MTRD-xxxxR series

The STP-MTRD-24 models have four “Variable I/O” points. Each can be configured as a digital input or a digital output. In addition, pre-defined functions such as motor enable or fault output can be assigned, providing the flexibility to handle a diverse range of applications.

SureMotion Pro™ is used to set each Variable I/O point as an input or output. SureMotion Pro™ can also be used to assign functions to each I/O point, or functions can be assigned “on the fly” from SCL streaming commands.

Connector Pin Diagram

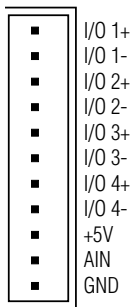

STP-MTRD-24xxR series

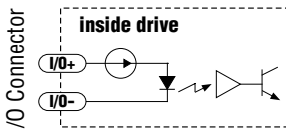

Equivalent Circuit: Variable I/O Point Set as Input

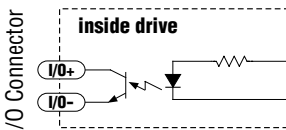

Equivalent Circuit: Variable I/O Point Set as Output

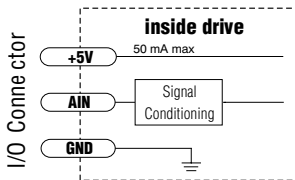

Equivalent Circuit: Analog Input

Input/Output Functions

Basic STP-MTRD-x I/O Functions (configure with dip switches)				
Terminal	STEP (5-24 Volts)	DIR (5-24 Volts)	EN (5-24 Volts)	OUT (30V, 80mA)
Function	Step Input	Dir Input	Enable Input	Alarm Output
	Limit CW	Limit CCW	-	-
Advanced STP-MTRD-17xR (23xR) I/O Functions (configure in software)				
Terminal	STEP (5-24 Volts)	DIR (5-24 Volts)	EN (5-24 Volts)	OUT (30V, 80mA)
Function	Step Input	Dir Input	Enable Input	Brake Output
	Jog CW	Jog CCW	Reset Input	Alarm Output
	Limit CW	Limit CCW	Change Speed	Motion Output
	Start/Stop	General Purpose	General Purpose	Tach Output
	General Purpose	-	-	General Purpose
Advanced STP-MTRD-24xR I/O Functions (configure in software)				
Terminal	I/O 1	I/O 2	I/O 3	I/O 4
Input Function	Step/CW Pulse/AB Quad Input	DIR/CCW Pulse/AB Quad Input	Limit CW Input	Limit CCW Input
	Jog CW Input	Jog CCW Input	Enable Input	Alarm Reset Input
	Enable Input	Alarm Reset Input	Change Speed Input	General Purpose Input
	Start/Stop Input	General Purpose Input	General Purpose Input	-
	General Purpose Input	-	-	-
Output Function	Brake Output	Brake Output	Brake Output	Brake Output
	Fault Output	Fault Output	Fault Output	Fault Output
	Motion Output	Motion Output	Motion Output	Motion Output
	Tach Output	Tach Output	Tach Output	Tach Output
	General Purpose Output	-	General Purpose Output	General Purpose Output

The Step (STEP) and Direction (DIR) Inputs

The STP-MTRD motor/drives include two high-speed inputs called STEP (or IN1) and DIR (or IN2). They accept 5 to 24 volt single-ended or differential signals, up to 2 MHz. Typically these inputs connect to an external controller that provides step and direction command signals. With the Advanced models you can also connect a master encoder to the high-speed inputs for “encoder following” applications. Or you can use these inputs with Wait Input, If Input, Feed to Sensor, Seek Home, and other SCL commands.



If the current is flowing into or out of an input, the logic state of that input is low or closed. If no current is flowing, or the input is not connected, the logic state is high or open.

Example connection diagrams:

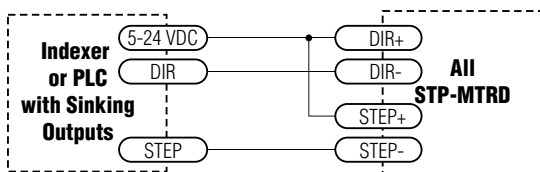

Connecting to indexer with Sinking Outputs

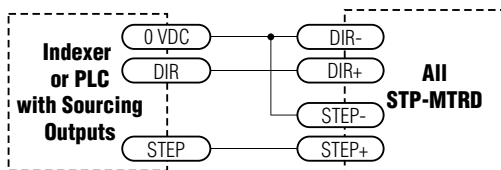

Connecting to indexer with Sourcing Outputs

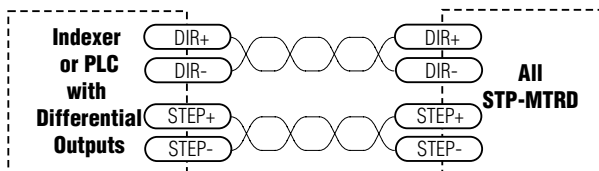

Connecting to indexer with Differential Outputs

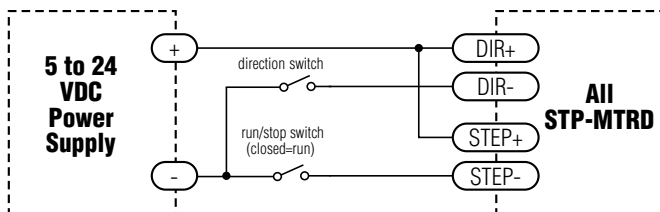

Using Mechanical Switches
(The switches can also be placed on the + line)

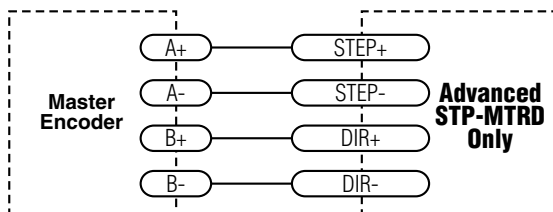

Wiring for Encoder Following

The Enable (EN/IN3) Digital Input

As mentioned in the previous section, the high-speed STEP and DIR inputs are designed for high speed operation. The Enable digital input is designed for low speed digital input operation between 5 and 24 volts DC.



If the current is flowing into or out of an input, the logic state of that input is low or closed (active). If no current is flowing, or the input is not connected, the logic state is high or open. Using a switch (see the first image below) to activate the "Enable" circuit will actually disable the drive. The switch in the image below could be considered a "Disable" switch.

Example connection diagrams:

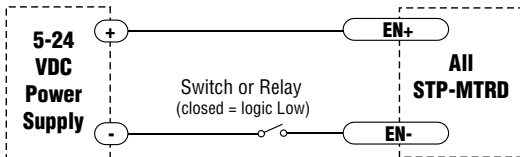

Connecting the Input to a Switch or Relay

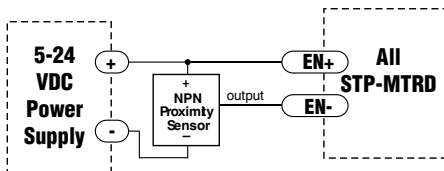

Connecting an NPN Type Proximity Sensor to an input
(When proximity sensor activates, input goes low).

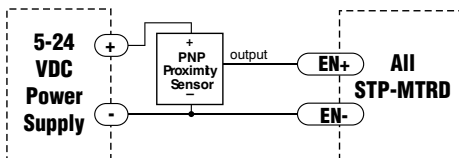

Connecting a PNP Type Proximity Sensor to an input
(When prox sensor activates, input goes low).

The Analog (AIN) Input

The Advanced STP-MTRD drives feature an analog input. The input can accept a signal range of 0 to 5 VDC. The drive can be configured to operate at a speed or position that is proportional to the analog signal. Use the SureMotion Pro software to set the signal range, offset, dead-band and filter frequency. For some SCL commands the analog input can be used as an emulated digital input by just using the full analog scale as the on/off condition. The Advanced STP-MTRD also provides a +5VDC 50mA output that can be used to power external devices such as potentiometers. It is not the most accurate supply for reference; for more precise readings use an external supply that can provide the desired accuracy.

Example connection diagram:

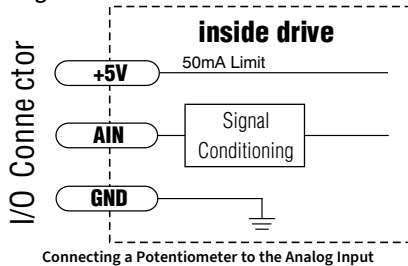

The Digital Output

The STP-MTRD drives feature one configurable optically isolated digital output. In the units with RS-485 communication this output can be set to automatically control a motor brake, to signal a fault condition, to indicate when the motor is moving, or to provide an output frequency proportional to motor speed (tach signal). The output can also be turned on and off by program instructions like Set Output. The output can be used to drive LEDs, relays, and the inputs of other electronic devices like PLCs and counters. The “OUT+” (collector) and “OUT-” (emitter) terminals of the transistor are available at the connector. This allows you to configure the output for current sourcing or sinking. The STP-MTRD-24 has four variable I/O points. Each one can be either an output or an input.



If current is flowing into or out of an output, the logic state of that output is low or closed (active). If no current is flowing, or the output is not connected, the logic state is high or open.



**Do not connect the output to more than 30VDC.
The current through the output terminal must not exceed 40mA.**

Example connection diagrams:

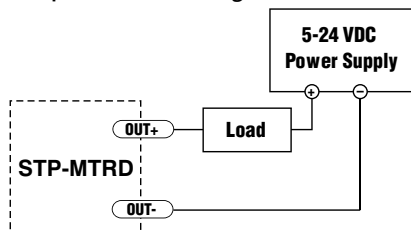

Connecting as a Sinking Output

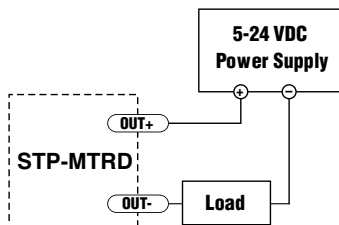

Connecting as a Sourcing Output

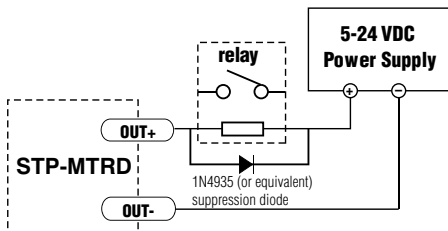

Driving a Relay

Using the Optional Encoder

(STP-MTRD-17038E, 23042E, 23065E)

The optional encoder that is included with the standard E models is a differential line driver 1000 ppr incremental encoder assembled to the rear shaft of the unit. This is replacement part number STP-MTRA-ENC1. The A, B, and Index (Z) channel signals of this encoder can be connected back to the external controller for position verification and enhanced performance, depending on the features of the controller. To facilitate connecting the encoder signals to your external controller you should purchase cable part number STP-CBL-EAx.

For more information on the encoder, please see the Accessories appendix. Replacement encoder part number is STP-MTRA-ENC1.

Incremental encoder specifications:

- 10-pin connector provides the following signals (pin assignments): Ground (1,2), Index- (3), Index+ (4), A- (5), A+ (6), +5VDC power (7,8), B- (9) and B+ (10).
- Power supply requirements: 5 VDC at 56mA typical, 59 mA max.
- The encoder's internal differential line driver can source and sink 20mA at TTL levels.
- Maximum noise immunity is achieved when the differential receiver is terminated with a 110-ohm resistor in series with a .0047 microfarad capacitor placed across each differential pair. The capacitor simply conserves power; otherwise power consumption would increase by approximately 20mA per pair, or 60mA for three pairs.
- If making your own cable to connect the encoder signals to your controller, we recommend using a shielded cable with four or five twisted pairs for improved noise immunity.
- Max encoder frequency is 100,000 pulses per second.

Other encoder configurations are available. Please see Appendix A for the full line of encoders compatible with the standard E series STP-MTRD integrated motor/drives.

CONNECTION TABLE		
CONN	LEAD COLOR	SIGNAL
PIN 2	GREEN/WHITE	GROUND
7	GREEN	POWER+
3	ORANGE/WHITE	Z-
4	ORANGE	Z+
5	BLUE/WHITE	A-
6	BLUE	A+
9	BROWN/WHITE	B-
10	BROWN	B+
1	N/C	GROUND
8	N/C	POWER+

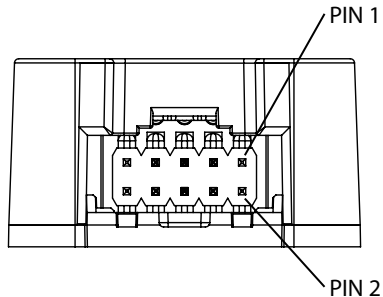

Note: Pin 1 and Pin 2 are internally connected. Pin 7 and Pin 8 are internally connected inside the encoder.

Configuring the Standard STP-MTRD

Step 1: Setting the Current

To achieve maximum torque, you should set the current to 100%. But under some conditions you may want to reduce the current to save power or lower motor

temperature. This is important if the motor is not mounted to a surface that will help it dissipate heat or if the ambient temperature is expected to be high.

Step motors produce torque in direct proportion to current, but the amount of heat generated is roughly proportional to the square of the current. If you operate the motor at 90% of rated current, you'll get 90% of the rated torque. But the motor will produce approximately 81% as much heat. At 70% current, the torque is reduced to 70% and the heating to about 50%.

Two of the small switches on the front of the STP-MTRD are used to set the percent of rated current that will be applied to the motor: SW1 and SW2. Please set them according to the illustration below.

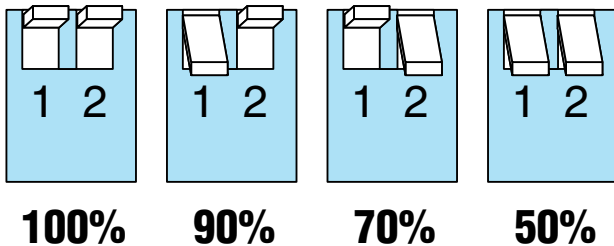

Step 2: Setting Idle Current

Motor heating and power consumption can also be reduced by lowering the motor current when it is not moving. The STP-MTRD will automatically lower the motor current when it is idle to either 50% or 90% of the running current. The 50% idle current setting will lower the holding torque to 50%, which is enough to prevent the load from moving in most applications. This reduces motor heating by 75%. In some applications, such as those supporting a vertical load, it is necessary to provide a high holding torque. In such cases, the idle current can be set to 90% as shown.

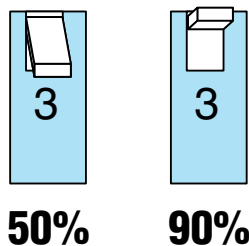

Step 3: Load Inertia

The Standard STP-MTRD includes anti-resonance and electronic damping features which greatly improve motor performance. To perform optimally, the drive must understand the electromechanical characteristics of the motor and load. Most of this is done automatically when the motor and drive are assembled at the factory. To further enhance performance, you must set a switch to indicate the approximate inertia ratio of the load and motor. The ranges are 0 to 4X and 5 to 10X. Please divide your load inertia by the STP-MTRD rotor inertia (82 g-cm²) to determine the ratio, then set switch 7 accordingly, as shown.

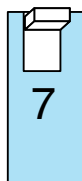
**5-10X****0-4X****Step 4: Step Size**

The Standard STP-MTRD requires a source of step pulses to command motion. This may be a PLC, an indexer, a motion controller or another type of device. The only requirement is that the device be able to produce step pulses whose frequency is in proportion to the desired motor speed, and be able to smoothly ramp the step speed up and down to produce smooth motor acceleration and deceleration.

Smaller step sizes result in smoother motion and more precise speed, but also require a higher step pulse frequency to achieve maximum speed. The smallest step size is 1/25,600th of a motor turn. To command a motor speed of 50 revolutions per second (3000 rpm) the step pulses frequency must be $50 \times 25,600 = 1.28$ MHz. Many motion devices, especially PLCs cannot provide step pulses at such a high speed. If so, the drive must be set for a lower number of steps per revolution. Sixteen different settings are provided, as shown in the diagrams on the next page.

Please choose the one that best matches the capability of your system.

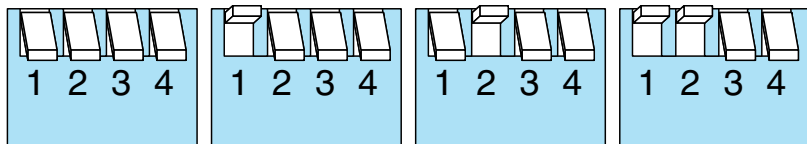

200

400

800

1600

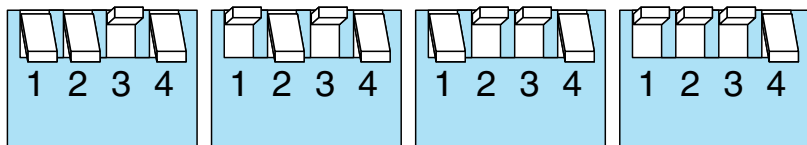

3200

6400

12800

25600

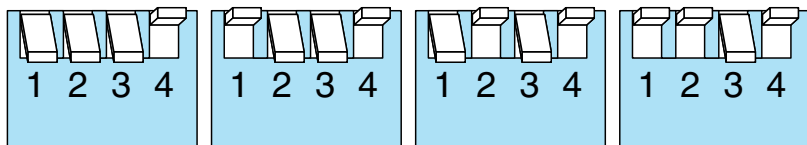

1000

2000

4000

5000

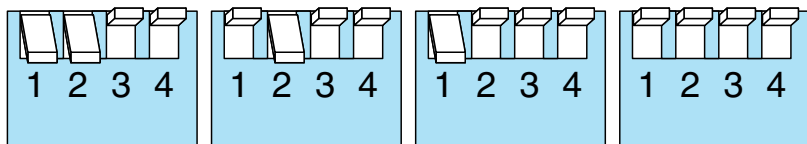

8000

10000

20000

25000

At lower step resolutions such as 200 steps/rev (full step) and 400 steps/rev (half step), motors run a little rough and produce more audible noise than when they are microstepped. The STP-MTRD includes a feature called “microstep emulation”, also called “step smoothing”, that can provide smooth motion from coarse command signals. If you set switch 6 to the ON position, this feature is automatically employed to provide the smoothest possible motion from a less than ideal signal source.

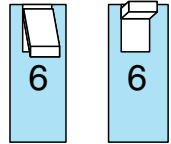

ON **OFF**
SMOOTHING

Because a command filter is used as part of the step smoothing process, there will be a slight delay, or “lag”, in the motion. The graph below shows an example of the delay that can occur from using the step smoothing filter.

Motion Profile with Step Smoothing Filter

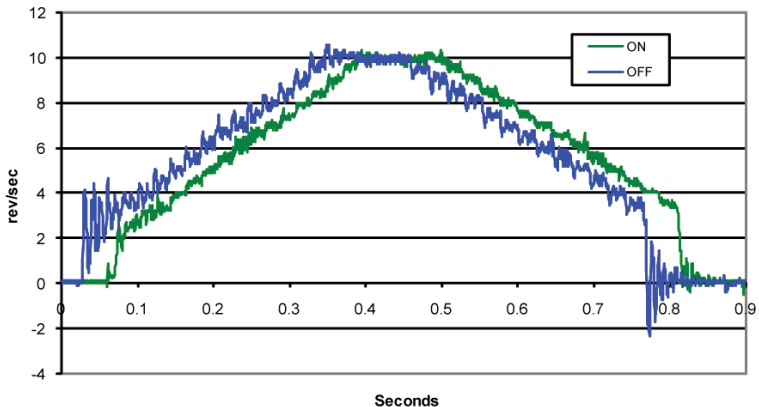

Step 5: Step Pulse Type

Most indexers and motion controllers provide motion commands in the “Step and Direction” format. The step signal pulses once for each motor step and the direction signal commands direction. However, a few PLCs use a different type of command signal: one signal pulses once for each desired step in the clockwise direction (called STEP CW), while a second signal pulses for counterclockwise motion (STEP CCW). The Standard STP-MTRD can accept this type of signal if you adjust switch 8 as shown in the diagram on the next page.

In STEP CW/STEP CCW mode, the CW signal should be connected to the STEP input and the CCW signal to the DIR input.



**STEP CW/
STEP CCW**

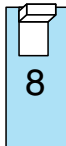

**STEP/
DIR**

Step 6: Step Pulse Noise Filter

Electrical noise can affect the STEP signal in a negative way, causing the drive to think that one step pulse is two or more pulses. This results in extra motion and inaccurate motor and load positioning. To combat this problem, the Standard STP-MTRD includes a digital noise filter on the STEP and DIR inputs. The default factory setting of this filter is 150 kHz, which works well for most applications. This is set by moving switch 5 to the ON position.

However, as discussed in Step 4, if you are operating the STP-MTRD at a high number of steps/rev and at high motor speeds, you will be commanding the drive at step rates above 150 kHz. In such cases, you should set switch 5 to the OFF position as shown.

Your maximum pulse rate will be the highest motor speed times the steps/rev. For example, 40 revs/second at 20,000 steps/rev is $40 \times 20,000 = 800$ kHz. Please consider this when deciding if you must increase the filter frequency.

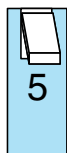

**150
KHZ**



**2.0
MHZ**

Self Test

If you are having trouble getting your motor to turn, you may want to try the built-in self-test. Any time switch 4 is moved to the ON position, the drive will automatically rotate the motor back and forth, two and a half turns each direction. This feature can be used to confirm that the motor is correctly wired and otherwise operational.



ON



OFF

SELF TEST

Drive/Motor Heating

Step motors convert electrical power from the driver into mechanical power to move a load. Because step motors are not perfectly efficient, some of the electrical power turns into heat on its way through the motor. This heating is not dependent on the load being driven but rather the motor speed and power supply voltage. There are certain combinations of speed and voltage at which a motor cannot be continuously operated without damage.

Provided below are curves showing the maximum duty cycle versus speed for each size at commonly used power supply voltages. Please refer to these curves when planning your application.

Also keep in mind that a step motor typically reaches maximum temperature after 30 to 45 minutes of operation. If you run the motor for one minute then let it sit idle for one minute, that is a 50% duty cycle. Five minutes on and five minutes off is also a 50% duty. However, one hour on and one hour off has the effect of 100% duty because during the first hour the motor will reach full (and possibly excessive) temperature.

The actual temperature of the motor depends on how much heat is conducted, convected, or radiated out of it. The measurements below were made in a 40°C (104°F) environment with the motor mounted to an aluminum plate sized to provide a surface area consistent with the motor power dissipation. Your results may vary.

Please use the motor body temperature curves below to determine the maximum duty cycle of the drive/motor under various conditions.

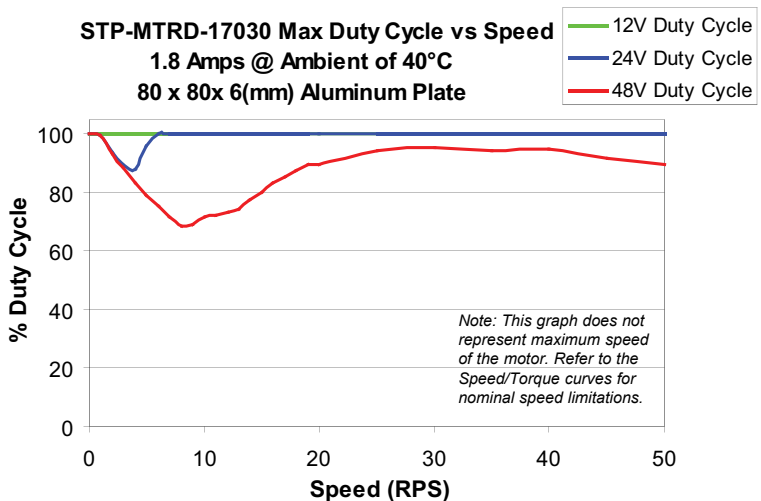

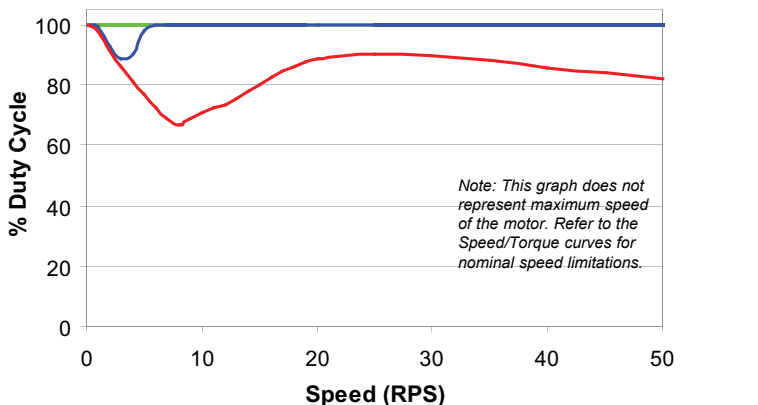
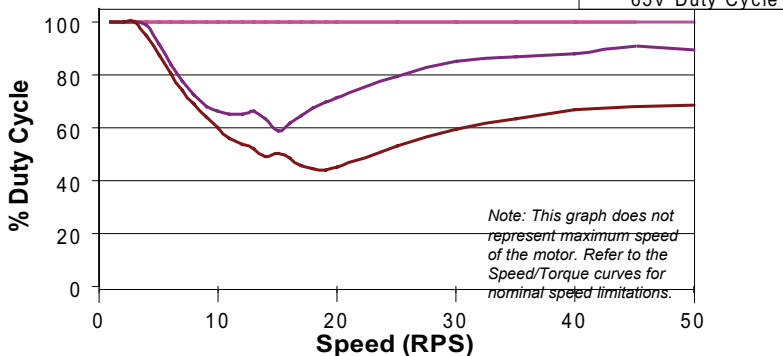
STP-MTRD-17038 Max Duty Cycle vs Speed**1.8 Amps @ Ambient of 40°C****80 x 80x 6(mm) Aluminum Plate****STP-MTRD-23042 Max Duty cycle vs Speed****5 Amps @ Ambient of 40°C****Mounted to a 6.4" x 6.4" x .25" Aluminum Plate**

STP-MTRD-23065 Max Duty cycle vs Speed 5 Amps @Ambient of 40°C

Mounted to a 6.4" x 6.4" x .25" Aluminum Plate

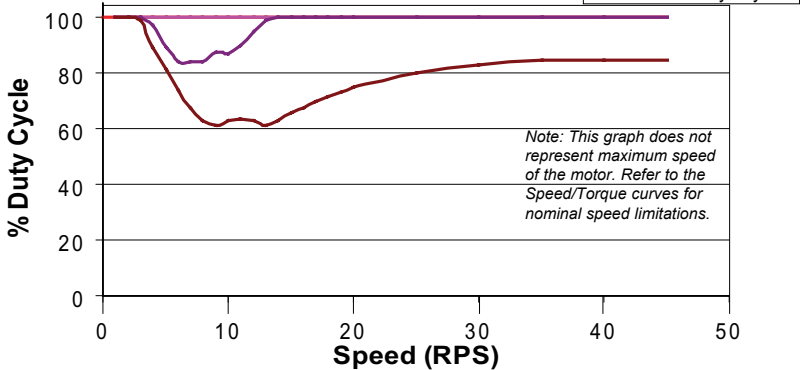

STP-MTRD-24075 Max Duty Cycle vs Speed 6A/phase, 40°C Ambient Mounted on a 162 x 162 x 6 (mm) Aluminum Plate

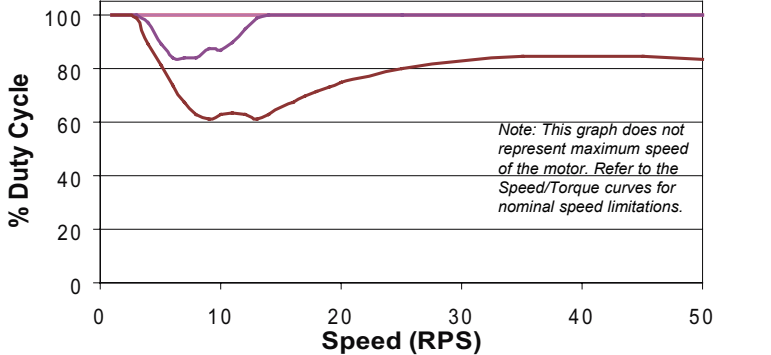

Torque Speed Graphs

STP-MTRD-17030 Torque vs Speed (1.8° step motor; 1/2 stepping)

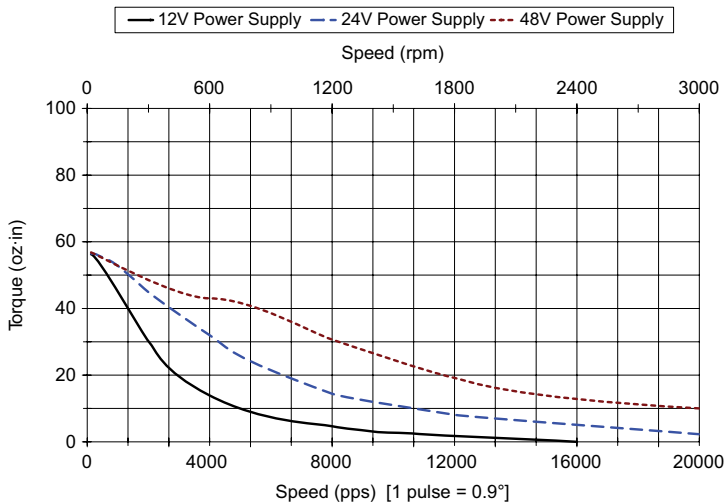

STP-MTRD-17038 Torque vs Speed (1.8° step motor; 1/2 stepping)

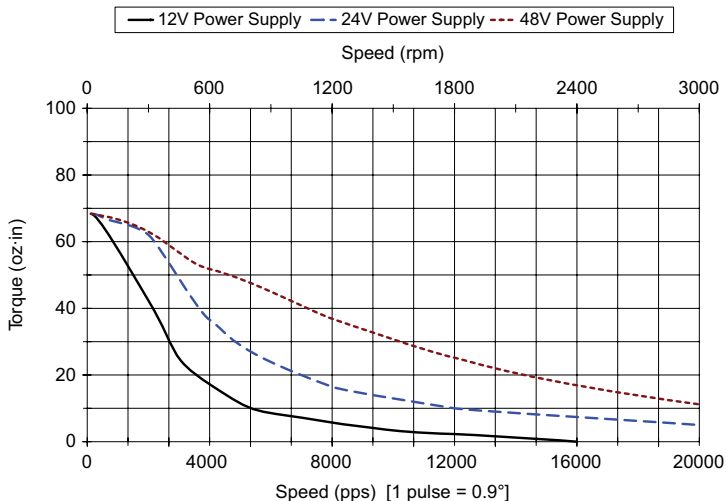

STP-MTRD-23042 Torque vs Speed (1.8° step motor; 1/2 stepping)

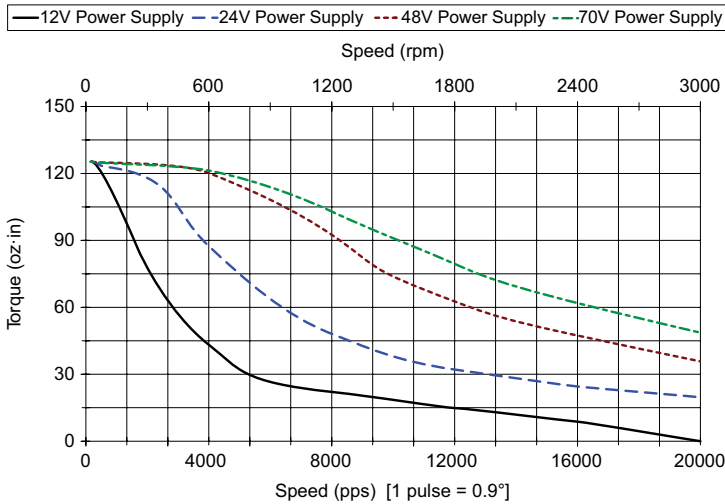

STP-MTRD-23065 Torque vs Speed (1.8° step motor; 1/2 stepping)

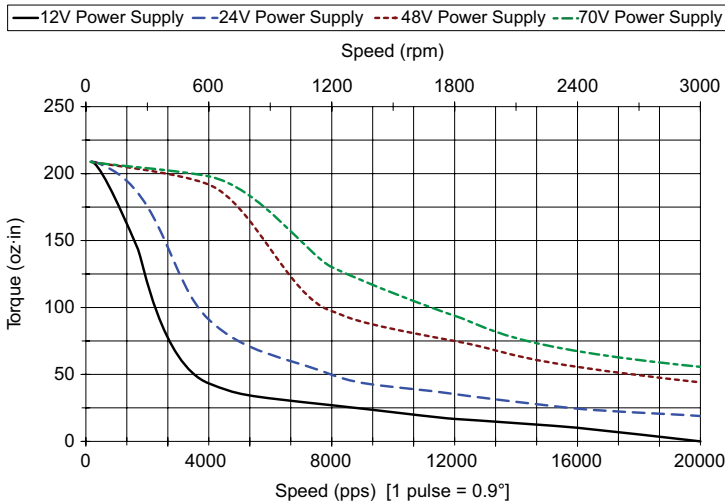

STP-MTRD-24075 Torque vs Speed (1.8° step motor; 1/2 stepping)

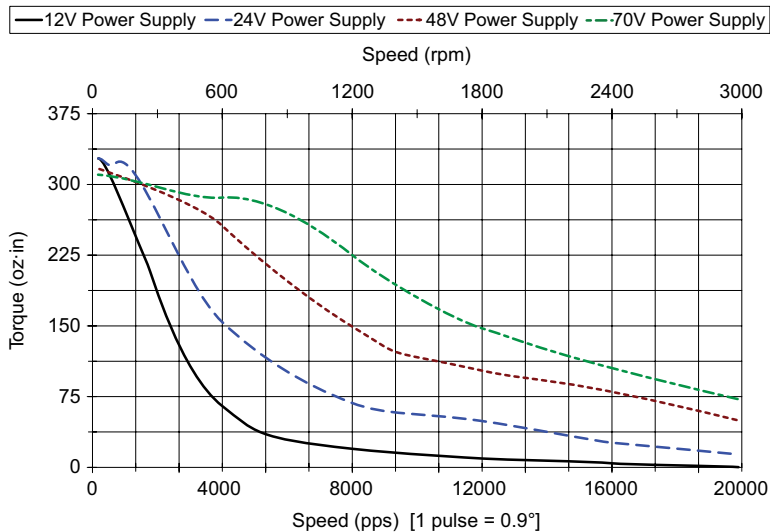

Dimensions and Mounting Slot Locations

Dimensions = inches [mm]

STP-MTRD-17030R / STP-MTRD-17030RE

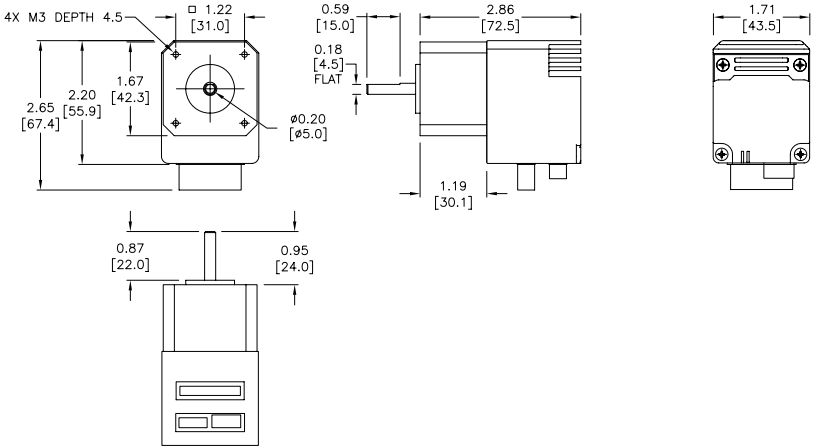

STP-MTRD-17038

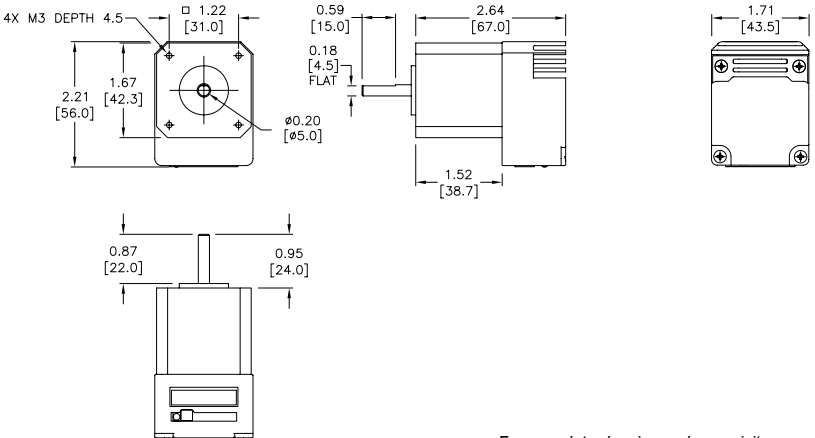

For complete drawings, please visit
www.automationdirect.com

STP-MTRD-17038E

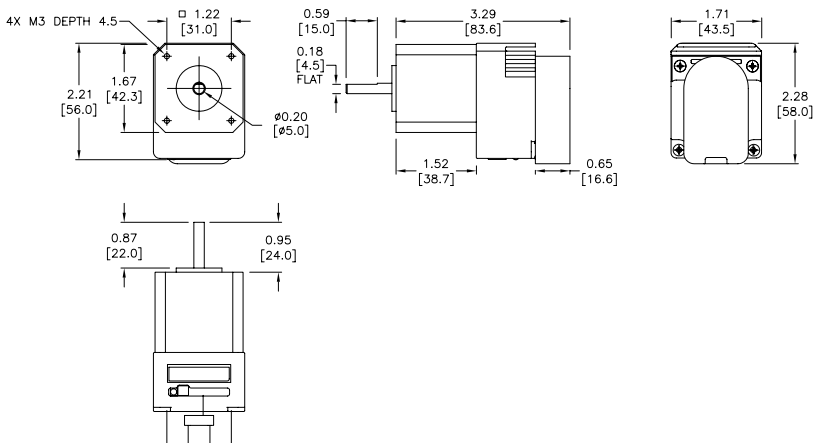

STP-MTRD-17038R / STP-MTRD-17038RE

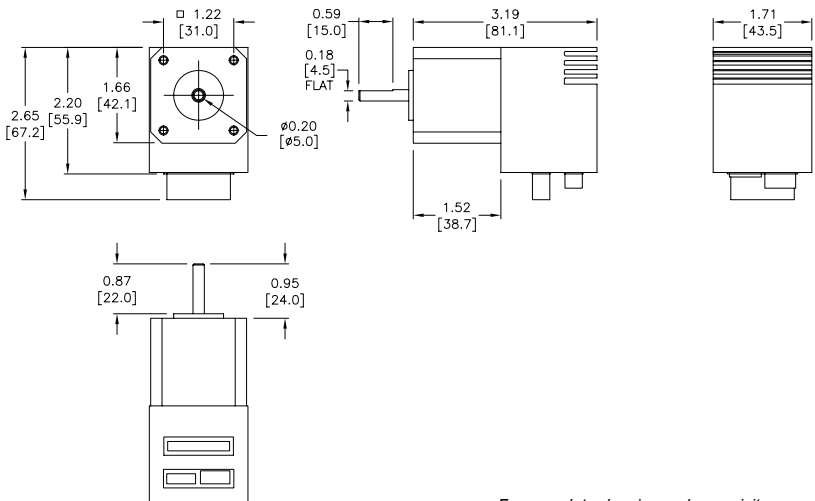

For complete drawings, please visit
www.automationdirect.com

STP-MTRD-23042

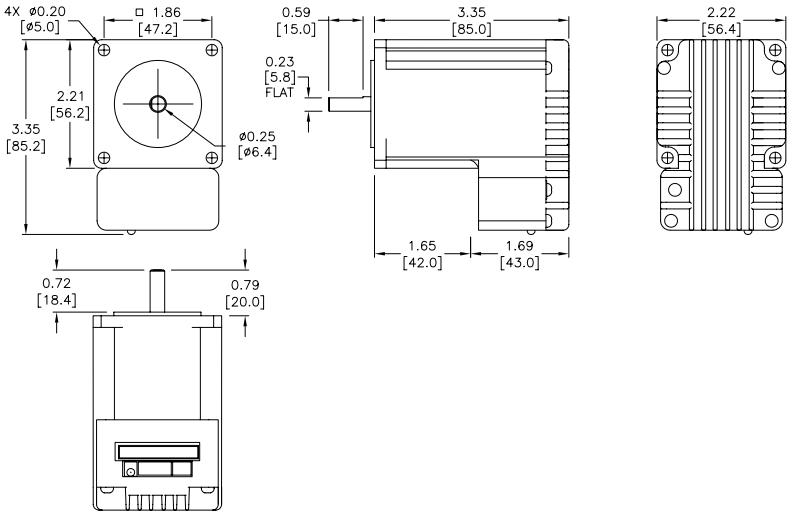

STP-MTRD-23042E

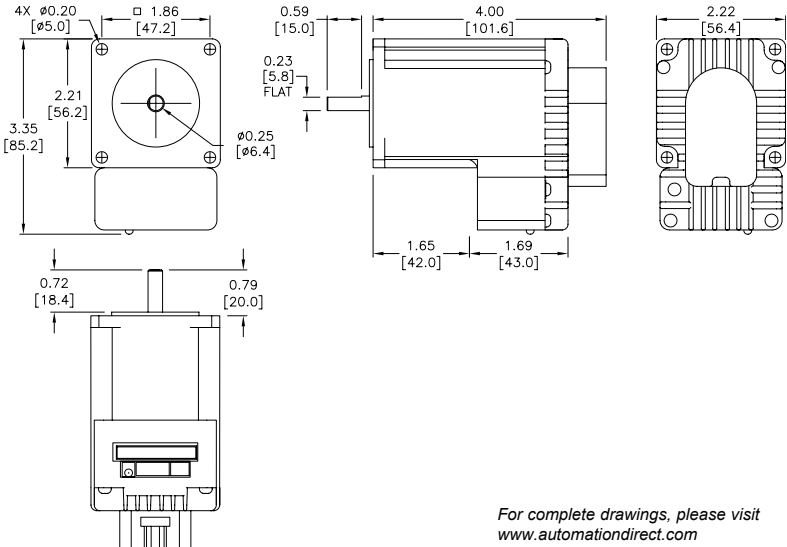

For complete drawings, please visit
www.automationdirect.com

STP-MTRD-23042R / STP-MTRD-23042RE

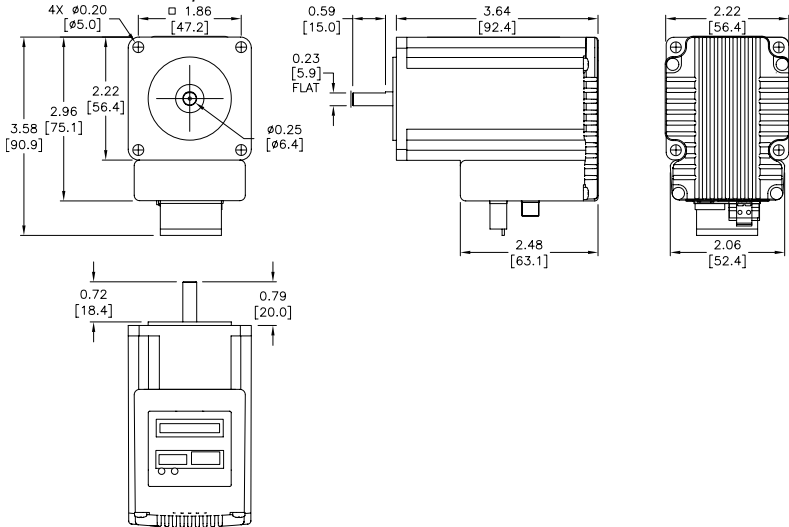

STP-MTRD-23065

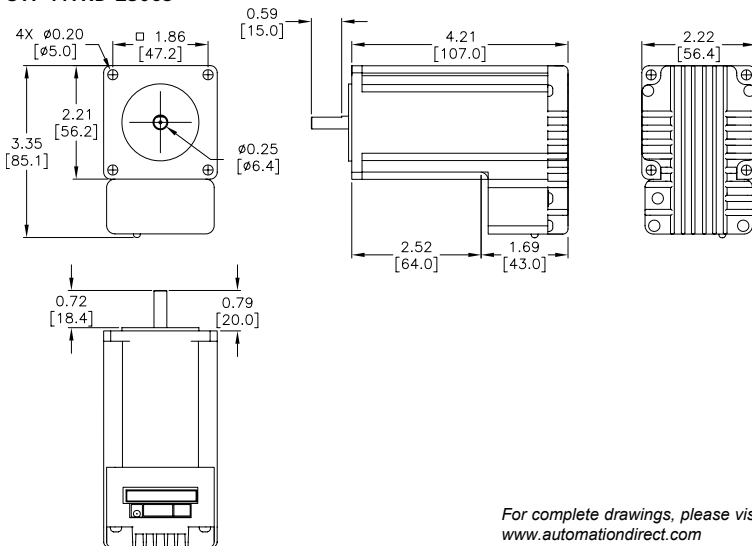

For complete drawings, please visit
www.automationdirect.com

STP-MTRD-23065E

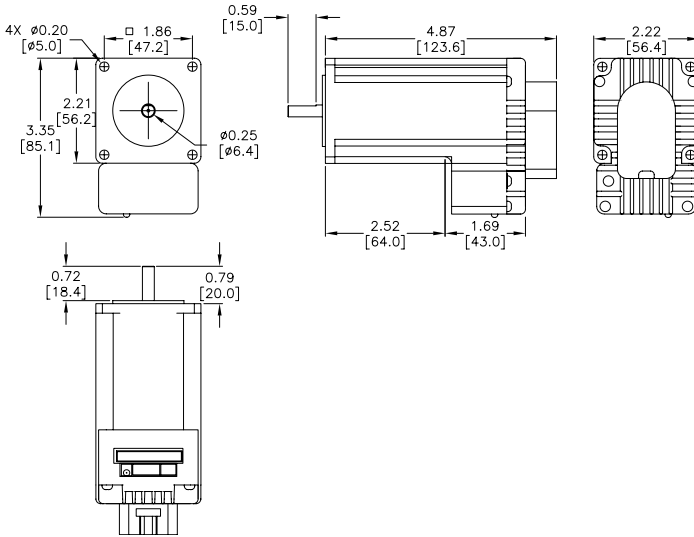

STP-MTRD-23065R / STP-MTRD-23065RE

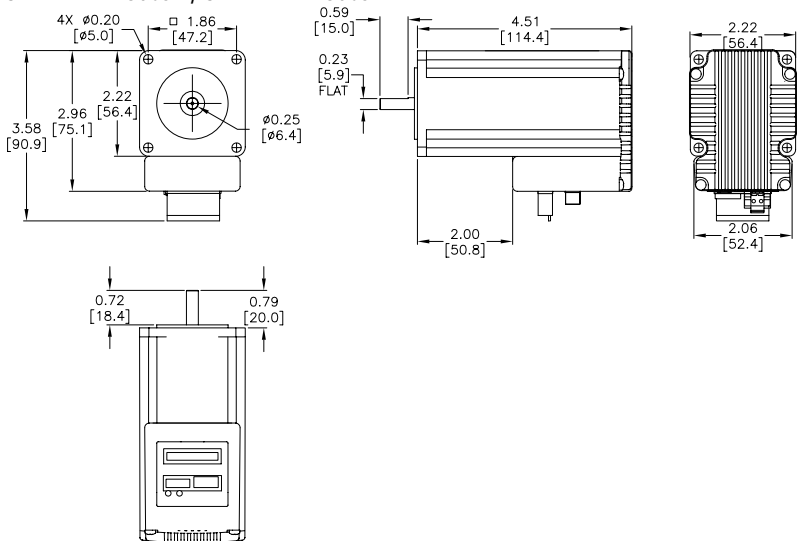

STP-MTRD-24075RV / STP-MTRD-24075RVE

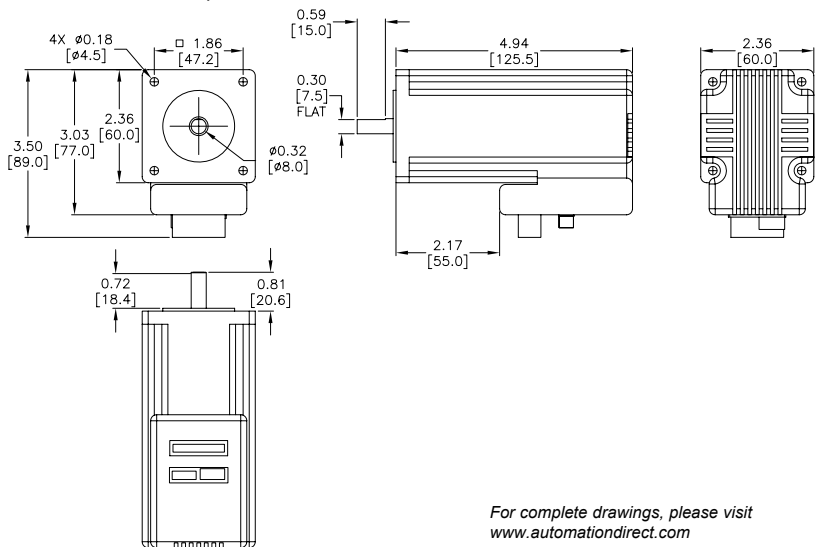

For complete drawings, please visit www.automationdirect.com

SURESTEP™
STEPPING MOTORS



CHAPTER
7

In This Chapter...

Features	7-2
Design and Installation Tips.....	7-3
Specifications	7-4
Power Supply and Step Motor Drive	7-7
Mounting the Motor	7-7
Connecting the Motor	7-7
Extension Cable Wiring Diagrams	7-8
Connecting a STP-MTRAC Motor	7-8
Motor Dimensions and Cabling	7-10
Typical Dimension & Cable Diagrams	7-10
Typical Dimension & Cable Diagram for STP-MTRH	7-13
Typical Dimension & Cable Diagram for STP-MTRAC	7-16
Torque vs. Speed Charts	7-18

Features

- Step motors available in NEMA 14, NEMA 17, NEMA 23, NEMA 34, and NEMA 42 frame sizes.
- Square frame style produces high torque and achieves best torque to volume ratio.
- Holding torque ranges from 8 to 4532 oz-in.
- Available in single-shaft, dual-shaft (encoder ready), encoder mounted, IP65 (wash-down), and high bus voltage configurations.
- 12-inch long connectorized cables attached to motors, with extension cables available in 6, 10, and 20 foot lengths. NEMA 23 and NEMA 34 high-bus voltage models (MTRAC-23 and MTRAC-34) have 10' long non-connectorized 8-lead cables.
- All NEMA 14, NEMA 17, NEMA 23, NEMA 34, and NEMA 42 dual-shaft motors come with pretapped holes ready for a modular encoder to be mounted.
- All “E” models include a premounted line driver encoder AMT112Q-V (replaces STP-MTRA-ENC9). The AMT112Q-V is a configurable encoder that comes preconfigured with 400ppr when shipped attached to a motor. Other ppr and output types are available for purchase. See Appendix A for more information on encoder options and configuration utility.
- All “W” model motors and extension cables include an IP65 connector attached to the cable.



Dual-shaft Versions Available



Encoder Versions Available



IP65 Versions Available



Note: Small holes are often drilled into the end of the rotor shaft. This is for manufacturing tooling purposes. These holes do not have a dimensional tolerance and cannot be guaranteed to be present on subsequent orders.

Design and Installation Tips

Allow sufficient time to accelerate the load and size the step motor with a 100% torque safety factor (i.e. design the system using a maximum of 50% of the motor's torque). DO NOT disassemble step motors, as motor performance will be reduced and the warranty will be voided. DO NOT connect or disconnect the step motor during operation.

The motor can be mounted in any orientation (horizontal or vertical). Mount it to a surface with good thermal conductivity, such as steel or aluminum, to allow heat dissipation. Use a flexible coupling with "clamp-on" connections to both the motor shaft and the load shaft to prevent thrust and radial loading on bearings from minor misalignment.

In general, the higher the current into a step motor the higher the torque, especially at lower speeds. The higher the voltage to the step motor, the higher the torque at higher speeds. Losses come in to play here, too. The higher you run the current on the motors, the higher your losses are going to be, and the hotter your motors are going to get. For this reason, AutomationDirect specs current for motors at the RMS value. This is the value on the motor's label and specification table. This guarantees a very long life for the motor. Multiplying the motor's RMS phase current by 1.2 gives a good balance of torque vs loss. This value should then be used to set the drive's peak phase current. Note that the whole speed torque curve won't be shifted up, only the low speed flat part before the torque starts dropping. The curve can drop for many reasons, but typically it's due to not having enough voltage to push the desired current into the windings, so increasing the voltage is what gives you a boost there, not making more current available.

For STP-MTRAC(H)-x motors or other high bus voltage motors ensure the drain wire or ground wire from the motor is properly grounded to the motor and drive's grounding lug. Also ensure the drive's grounding point is properly grounded to the panel ground.

Specifications

SureStep™ Series Specifications – Connectorized Bipolar Stepping Motors							
Bipolar Stepping Motors		Low Torque Motors		High Torque Motors			
		STP-MTRL-14026x	STP-MTRL-14034x	STP-MTR-17040x	STP-MTR-17048x	STP-MTR-17060x	STP-MTR-23055x
NEMA Frame Size		14	14	17	17	17	23
Optional Encoder		Y	Y	Y	Y	Y	Y
* Max Holding Torque	(lb-in)	0.5	1.25	3.81	5.19	7.19	10.37
	(oz-in)	8	20	61	83	115	166
	(N-m)	0.06	0.14	0.43	0.59	0.81	1.17
Rotor Inertia	(oz-in ²)	0.06	0.08	0.28	0.37	0.56	1.46
	(kg-cm ²)	0.0003	0.00035	0.05	0.07	0.10	0.27
Rated RMS Current (A/phase)		0.35	0.8	1.7	2.0	2.0	2.8
Resistance (Ω/phase)		8.5	7.66	1.6	1.4	2.0	0.75
Inductance (mH/phase)		5.77	6.92	3.0	2.7	3.3	2.4
Insulation Class		130°C [266°F] Class B; 300V rms					
Basic Step Angle		1.8°					
Shaft Runout		0.002 in [0.051 mm]					
Max Shaft Radial Play @ 1lb load		0.001 in [0.025 mm]					
Perpendicularity		0.003 in [0.076 mm]					
Concentricity		0.003 in [0.076 mm]					
*Max Radial Load (lb [kg])		6.0 [2.7]					15.0 [6.8]
*Max Axial (Thrust) Load (lb [kg])		6.0 [2.7]					13.0 [5.9]
Storage Temperature		-20°C to 100°C [-4°F to 212°F]					
Operating Temperature		-20°C to 50°C [-4°F to 122°F] (motor case temperature should be kept below 80°C [176°F])					
Operating Humidity		55% to 85% non-condensing					
Product Material		steel motor case; stainless steel (SUS 303) shaft(s)					
Environ. Rating		IP40		IP40, IP65 (W motors only)			
Weight (lb [kg]) (E models)		0.25 [0.11] (0.3 [0.1])	0.35 [0.15] (0.4 [0.2])	0.6 [0.3] (0.7 [0.3])	0.7 [0.3] (0.8 [0.4])	0.9 [0.4] (0.9 [0.4])	1.5 [0.7] (1.5 [0.7])
Agency Approval		CE					
Accessory Extension Cable		STP-EXTL-006, 010, 020		STP-EXT-006, 010, 020 STP-EXTW-006, 010, 020 (W motors only)			
* For dual-shaft motors (STP-MTR-xxxxD): The sum of the front and rear Torque Loads, Radial Loads, and Thrust Loads must not exceed the applicable Torque, Radial, and Thrust load ratings of the motor.							

Specifications (continued)

Table continued from previous page							
SureStep™ Series Specifications – Connectorized Bipolar Stepping Motors							
Bipolar Stepping Motors		High Torque Motors		Higher Torque Motors			
		STP-MTR-23079x	STP-MTR-34066x	STP-MTRH-23079x	STP-MTRH-34066x	STP-MTRH-34097x	STP-MTRH-34127x
NEMA Frame Size		23	34	23	34	34	34
Optional Encoder		Yes					
Max Holding Torque	(lb-in)	17.25	27.12	17.87	27.12	50.00	80.50
	(oz-in)	276	434	286	434	800	1288
	(N-m)	1.95	3.06	2.02	3.06	5.65	9.10
Rotor Inertia	(oz-in ²)	2.60	7.66	2.60	7.66	14.80	21.90
	(kg-cm ²)	0.48	1.40	0.48	1.40	2.71	4.01
Rated RMS Current (A/phase)		2.8	2.8	5.6	6.3	6.3	6.3
Resistance (Ω/phase)		1.1	1.11	0.4	0.25	0.3	0.49
Inductance (mH/phase)		3.8	6.6	1.2	1.5	2.1	4.1
Insulation Class		130°C [266°F] Class B; 300V rms					
Basic Step Angle		1.8°					
Shaft Runout		0.002 in [0.051 mm]					
Max Shaft Radial Play @ 1lb load		0.001 in [0.025 mm]					
Perpendicularity		0.003 in [0.076 mm]					
Concentricity		0.003 in [0.076 mm]					
Maximum Radial Load (lb [kg])		15.0 [6.8]	39.0 [17.7]	15.0 [6.8]	39.0 [17.7]		
Max Axial (Thrust) Load (lb [kg])		13.0 [5.9]	25.0 [11.3]	13.0 [5.9]	25.0 [11.3]		
Storage Temp.		-20°C to 100°C [-4°F to 212°F]					
Operating Temperature		-20°C to 50°C [-4°F to 122°F] (motor case temperature should be kept below 80°C [176°F])					
Operating Humidity		55% to 85% non-condensing					
Product Material		steel motor case; stainless steel (SUS 303) shaft(s)					
Environmental Rating		IP40 IP65 (W motors only)					
Weight (lb [kg]) (E models)		2.2 [1.0] (2.4 [1.1])	3.9 [1.7]	2.4 [1.1] (2.4 [1.1])	3.9 [1.7]	5.9 [2.7]	8.4 [3.8]
Agency Approval		CE					
Accessory Extension Cable		STP-EXT-006, 010, 020 STP-EXTW-006, 010, 020 (W motors only)		STP-EXTH-006, 010, 020 STP-EXTWH-006, 010, 020 (W motors only)			

Specifications (continued)

SureStep™ Series Specifications – Non-connectorized Bipolar Stepping Motors							
Bipolar Stepping Motors	High Bus Voltage Motors						
	STP-MTRAC-23044(x)	STP-MTRAC-23055(x)	STP-MTRAC-23078(x)	STP-MTRAC-34075(x)	STP-MTRAC-34115(x)	STP-MTRAC-34156(x)	
NEMA Frame Size	23	23	23	34	34	34	
Optional Encoder ¹	Y	Y	Y	Y	Y	Y	
Max Holding Torque	(lb-in)	4.69	9.31	14.19	51.31	69.38	115.06
	(oz-in)	75	149	227	821	1110	1841
	(N-m)	0.53	1.05	1.6	5.8	7.84	13
Rotor Inertia	(oz-in ²)	0.66	1.64	2.62	7.38	14.74	24.06
	(g-cm ²)	120	300	480	1350	2700	4400
Rated RMS Current (A/phase)	Series	0.71	0.71	0.71	2.15	2.05	2.55
	Parallel	1.41	1.41	1.41	4.3	4.1	5.1
Resistance (Ω/phase)	Series	12.4	14.4	18	4	4.8	4.8
	Parallel	3.1	3.6	4.5	1.0	1.2	1.375
Inductance (mH/phase)	Series	30.4	51.2	60.8	32	43.2	44.8
	Parallel	7.6	12.8	15.2	8.0	10.8	11.2
Insulation Class	B						
Steps per Revolution	200						
Basic Step Angle	1.8°						
Shaft Runout	0.05 mm						
Max Shaft Radial Play @ 1lb load	0.02 in			0.025 in		0.02 in	
Max End Play @ 2.2-lb Axial Load	0.08 in			0.075 in		0.08 in	
Connectors	8 leads, 24AWG			8 leads, 22AWG			
Temperature Rise	80°C max						
Storage Temp.	-40°C to 70°C [-40°F to 158°F]						
Operating Temperature	-20°C to 50°C [-4°F to 122°F]						
Operating Humidity	5% to 95% non-condensing						
Product Material	Steel motor case, stainless steel shaft(s)						
Environmental Rating	IP40						
Weight (lb [kg])	1.03 [0.47]	1.54 [0.7]	2.2 [1.0]	4.2 [1.9]	8.4 [3.8]	11.464 [5.2]	
Agency Approval	None			cUR _{us}			

¹ - Only Dual-shaft motors (suffix = "D") are encoder ready.

Specifications (continued)

SureStep™ Series Specifications – Connectorized Stepping Motors							
Stepping Motors	Higher Bus Voltage Motors						
	STP-MTRAC-42100x	STP-MTRAC-42151x	STP-MTRAC-42202x	STP-MTRAC-42100x	STP-MTRAC-42151x	STP-MTRAC-42202x	
NEMA Frame Size	42	42	42	42	42	42	
Optional Encoder ¹	Y	Y	Y	Y	Y	Y	
Max Holding Torque (N·m)	<i>Unipolar Series</i>	9.7	19.0	26.0	9.7	17.5	26.0
	<i>Bipolar Series</i>	12.2	22.0	31.0	12.3	22.0	32.0
	<i>Bipolar Parallel</i>	12.2	22.0	31.0	12.3	22.0	32.0
Rotor Inertia (g·cm ²)	5500	10900	16200	5500	10900	16200	
Rated RMS Current (A/phase)	<i>Unipolar Series</i>	6	9.4	9	8.5	11.3	11.5
	<i>Bipolar Series</i>	4.2	6	6	6	8	8
	<i>Bipolar Parallel</i>	8.4	12	12	12	16	16
Resistance (Ω/phase)	<i>Unipolar Series</i>	0.6	0.34	0.46	0.32	0.215	0.29
	<i>Bipolar Series</i>	1.19	0.68	0.91	0.64	0.43	0.58
	<i>Bipolar Parallel</i>	0.3	0.17	0.23	0.159	0.108	0.144
Inductance (mH/phase)	<i>Unipolar Series</i>	5	3.6	5.5	2.5	1.9	3.2
	<i>Bipolar Series</i>	19.8	14.5	22	10.1	7.6	13
	<i>Bipolar Parallel</i>	5	3.6	5.5	2.5	1.9	3.2
Insulation Class	B						
Steps per Revolution	200						
Basic Step Angle	1.8°						
Shaft Runout	0.05 mm						
Max Shaft Radial Play @ 1lb load	1.1 in						
Connectors	8 leads, 18AWG						
Temperature Rise	80°C max						
Storage Temp.	-30°C to 70°C [-22°F to 158°F]						
Operating Temperature	-20°C to 40°C [-4°F to 104°F]						
Operating Humidity	5% to 95% non-condensing						
Product Material	Steel motor case, stainless steel shaft(s)						
Environmental Rating	IP40						
Weight (lb [kg])	10.6 [4.8]	17.6 [8]	25.6 [11.6]	10.6 [4.8]	17.6 [8]	25.6 [11.6]	
Agency Approval	cUR _{US}						

¹ Only Dual Shaft motors (suffix = "D") are Encoder Ready. NEMA 42 motors require an STP-MTRA-42ENC adapter plate for encoder mounting (holes pre-drilled and tapped for Same Sky AMT31/AMT33 or US Digital E6).

Power Supply and Step Motor Drive

An STP-PWR-xxxx linear power supply from AutomationDirect is the best choice to power AutomationDirect and other DC-input stepper drives. These power supplies were designed to work with the AutomationDirect SureStep™ STP-DRV-xxxx series bipolar DC microstepping motor drives. PSBxx switching power supplies are also available from AutomationDirect.



SureStep STP-MTRAC series motors (NEMA23 and NEMA34 only) and STP-DRVAC drives are designed for high bus voltages (120VAC, 240VAC drive input). Higher DC power supply voltages and AC-input stepper drives generate very high bus voltages and will result in excessive losses (heat) in the motors unless they are designed for it (see STP-MTRAC motors and STP-DRVAC drives). Do not use low-voltage motors in a high bus voltage system.

Always check the motor specs and speed-torque curves to determine allowable drive input voltage. To minimize heat loss in the motor, always choose the lowest input voltage that satisfies the application's speed-torque requirements.

Mounting the Motor

We recommend mounting the motor to a metallic surface to help dissipate heat generated by the motor.

Connecting the Motor



WARNING: *When connecting a step motor to a drive or indexer, be sure that the motor power supply is switched off. Never disconnect the motor while the drive is powered up. Never connect the motor leads to ground or directly to the power supply.*

All SureStep STP-MTR series motors have connectorized cables which connect directly to available SureStep extension cables. Due to the different current ranges of the three motor torque classes, three different ampacity rated cables are available in three different lengths. The MTRL motors use EXTL cables, the MTR motors use EXT cables, and the MTRH motors use EXTH cables. The extension cables have the same wire color coding as the motor pigtail cables, as shown in the extension cable wiring diagram and in the motor dimension and cabling diagram. The NEMA 23 and NEMA 34 high bus voltage MTRAC motors have 8-lead, 10-foot cables (no in-line connectors or extension cables). NEMA 42 STP-MTRAC(H)-42x motors have a connectorized cable that will mate with the STP-EXT42(H) extension cables.

Extension Cable Wiring Diagrams

STP-EXTx-xxx Cables

EXT & EXTH CABLES

PIN#	COLOR	PHASE
1	RED	A+
2	WHITE	A-
3	GREEN	B+
4	BLACK	B-



EXTL CABLES

PIN#	COLOR	PHASE
1	RED	A+
2	WHITE	A-
3	GREEN	B+
4	BLACK	B-

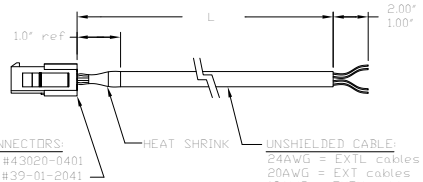

CONNECTORS:

EXT: Molex #43020-0401
 EXTH: Molex #39-01-2041
 EXTL: TE #103653-3

UNSHIELDED CABLE:
 24AWG = EXTL cables
 20AWG = EXT cables
 18AWG = EXTH cables

STP-EXTxW-xxx Cables

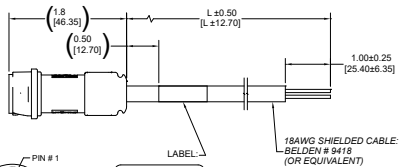
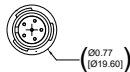

PIN #	COLOR	PHASE
1	RED	A+
2	WHITE	A-
3	GREEN	B+
4	BLACK	B-
5	GROUND	GROUND
6	N/A	N/A

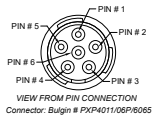

STP-EXTW-0XX
 or
 STP-EXTHW-0XX

STP-EXT42(H)-xxx Cables

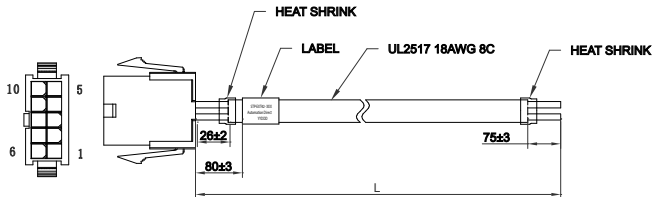

Pin	Wire Description
1	A - White
2	Ā - Orange
3	C - Green
4	C̄ - Brown
5	B - Red
6	B̄ - Yellow
7	D - Black
8	D̄ - Blue
9	GND - Drain wire

For stepper drive connections (A+, A-, B+, B-), see wiring diagrams on page 7-11.

Connecting a STP-MTRAC-23x or STP-MTRAC-34x Motor

The NEMA 23 and NEMA 34 STP-MTRAC series high bus voltage motors have eight leads and should be wired using the diagrams below:

STP-MTRAC-230xx(x), 34156(x)

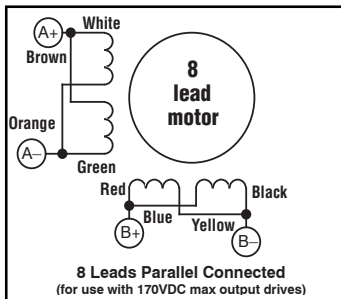
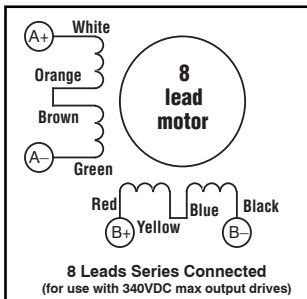

Use the series winding diagram with STP-DRVAC-24025 drives (115 or 230 VAC)

Warning!! Do NOT use this parallel winding diagram with STP-DRVAC-24025 drives

STP-MTRAC-34075(x), 34115(x)

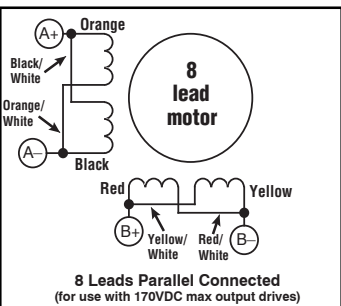
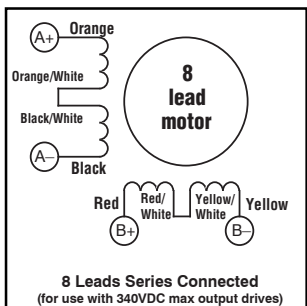

Use the series winding diagram with STP-DRVAC-24025 drives (115 or 230 VAC)

Warning!! Do NOT use this parallel winding diagram with STP-DRVAC-24025 drives

Connecting a STP-MTRAC(H)-42 Motor

The STP-MTRAC(H)-42 series higher bus voltage motors have eight leads and should be wired using the diagrams below:

Uni-polar

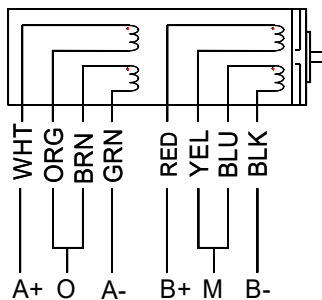

Bi-polar series

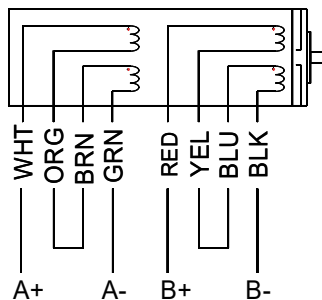

Bi-polar parallel

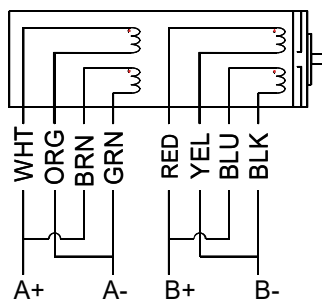

NOTE: Bipolar Series will be the most common application. The larger Bipolar Parallel motors require 12A and 16A current from a stepper drive.

Motor Dimensions and Cabling

Typical Dimension & Cable Diagrams

STP-MTR-xxxxx

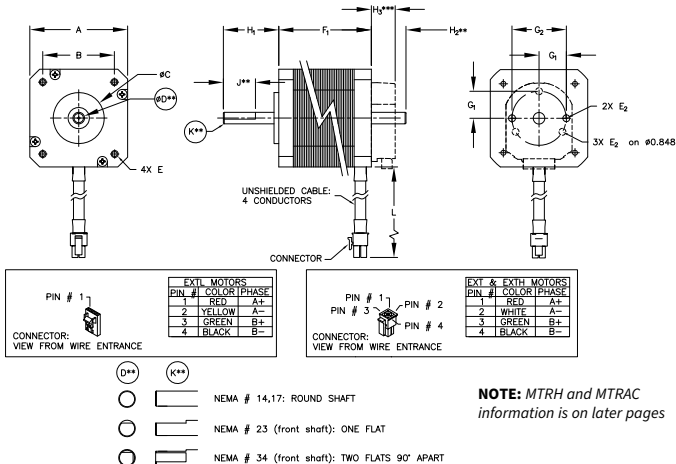

NOTE: MTRH and MTRAC information is on later pages

STP-MTR-xxxxxW

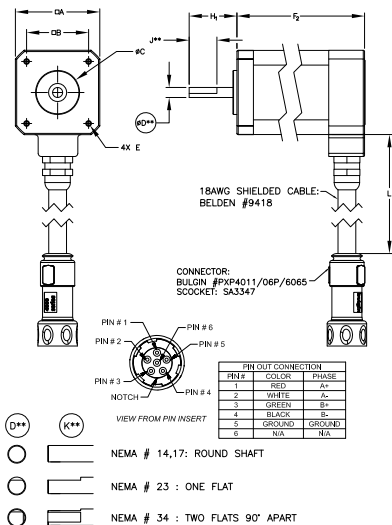

STP-MTR-34xxx

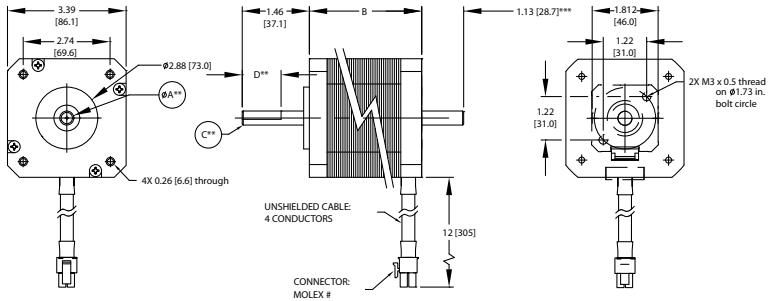

EXTL MOTORS		
PIN #	COLOR	PHASE
1	RED	A+
2	YELLOW	A-
3	GREEN	B+
4	BLACK	B-

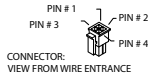

EXT & EXTH MOTORS		
PIN #	COLOR	PHASE
1	RED	A+
2	WHITE	A-
3	GREEN	B+
4	BLACK	B-



NEMA # 34 (front shaft): TWO FLATS 90° APART

- ** Dimension A is the same for both front and rear shafts of dual-shaft motors.
- ** Dimensions C & D do NOT apply to rear shafts of dual-shaft motors (all rear shafts are round style).
- *** Dimension applies only to dual-shaft (D) motors.

SureStep™ Series Dimensions & Cabling – STP-MTR-x*** Step Motors								
Dimensions (in [mm])*	Low Torque Motors		High Torque Motors STP-MTR-x					
	STP-MTRL -14026x	STP-MTRL -14034x	STP-MTR -17040x	STP-MTR -17048x	STP-MTR -17060x	STP-MTR -23055x	STP-MTR -23079x	STP-MTR -34066x
A	1.39 [35.3]		1.67 [42.3]			2.25 [57.2]		3.39 [86.1]
B	1.02 [25.9]		1.22 [31.0]			1.86 [47.2]		2.74 [69.6]
C	Ø 0.87 [22.1]					Ø 1.50 [38.1]		Ø 2.88 [73.0]
D**	Ø 0.20 [5.0]					Ø 0.25 [6.4]		Ø 0.50 [12.7]
E	4-40 thread 0.15 [3.8] min depth		M3 x 0.5 thread 0.15 [3.8] min depth			Ø 0.20 [5.1] through		Ø 0.26 [6.6] through
E ²	M2.5 X 0.45 thread				M2 x 0.4 thread	4-40		M2.5 x 0.45 thread
E ³	n/a							M3 x 0.5 thread on a 1.73 in. bolt circle
F ₁ **	1.02 [25.9]	1.34 [34.0]	1.58 [40.1]	1.89 [48.0]	2.34 [59.5]	2.22 [56.4]	3.10 [78.7]	2.64 [67.1]
F ₂ **	n/a		1.90 [48.3]	2.24 [56.9]	2.67 [67.8]	2.33 [59.1]	3.19 [81.0]	2.64 [67.1]
G ¹	0.375 [9.5]				0.411 [10.4]	0.906 [23]		n/a
G ²	0.75 [19.1]				n/a	1.812 [46]		
G ³	n/a							1.22 [31]
H ₁	0.60 [15.2]		0.94 [24.0]			0.81 [20.6]		1.46 [37.1]
H ₂ **	0.51 [13.0]		0.51 [13]			0.51 [13]		1.13 [28.7]
H ₃ **	0.40 [10.1]							n/a
J**	n/a					0.59 [15.0]		0.98 [25.0]
K**	n/a					0.23 [5.8]		0.45 [11.4]
L	12 [305]							
Conductor	(4) #26 AWG		(4) #20 AWG (5) #18 AWG (for W motors)					
Connector	TE # 103653-3		Molex # 43025-0400 PXP4010/06S/6065 (for W motors)					
Pin	TE # 1-104505-3 (LOOSE)		Molex # 43030-0007 Socket: SA3347 (for W motors)					

* mm dimensions are for reference purposes only.

** Dimension D (shaft diameter) is the same for both front and rear shafts of dual-shaft and encoder motors. Dimension H2 applies only to dual-shaft (D) and encoder (E) motors. Dimensions J & K do NOT apply to rear shafts of dual-shaft or encoder motors (all rear shafts are round style). Dimension H3 applies only to "E" models with the encoder pre-mounted. Dimension F2 applies to "W" models only.

*** Higher Torque STP-MTRH and high bus voltage STP-MTRAC motors are shown in a separate table.

Typical Dimension & Cable Diagram for STP-MTRH

STP-MTRH-23079x

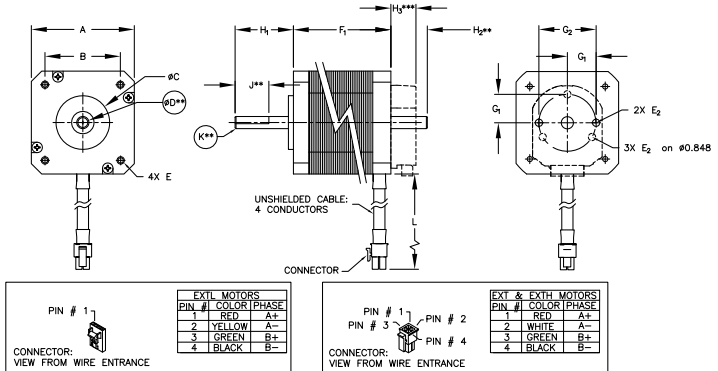

- D****
- K****
- NEMA # 14,17: ROUND SHAFT
- NEMA # 23 (front shaft): ONE FLAT
- NEMA # 34 (front shaft): TWO FLATS 90° APART

NOTE: NEMA 34 motor on the next page.

STP-MTRH-xxxxxW

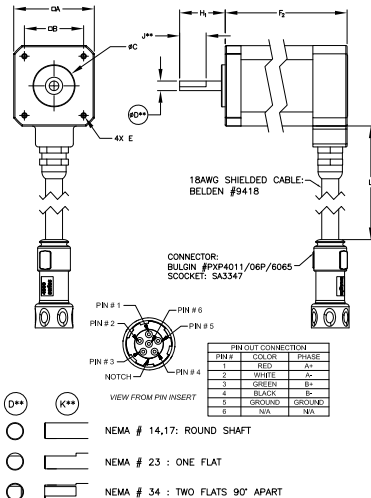

NOTE: STP-MTRAC information is on later pages

- D****
- K****
- NEMA # 14,17: ROUND SHAFT
- NEMA # 23 : ONE FLAT
- NEMA # 34 : TWO FLATS 90° APART

STP-MTRH-34xxx

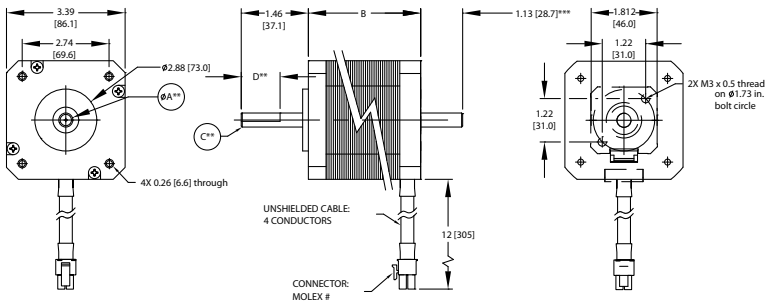

PIN # 1



CONNECTOR:
VIEW FROM WIRE ENTRANCE

EXTL MOTORS		
PIN #	COLOR	PHASE
1	RED	A+
2	YELLOW	A-
3	GREEN	B+
4	BLACK	B-

PIN # 1



CONNECTOR:
VIEW FROM WIRE ENTRANCE

EXT & EXTH MOTORS		
PIN #	COLOR	PHASE
1	RED	A+
2	WHITE	A-
3	GREEN	B+
4	BLACK	B-



NEMA # 34 (front shaft): TWO FLATS 90° APART

- ** Dimension A is the same for both front and rear shafts of dual-shaft motors.
- ** Dimensions C & D do NOT apply to rear shafts of dual-shaft motors (all rear shafts are round style).
- *** Dimension applies only to dual-shaft (D) motors.

SureStep™ Series Dimensions & Cabling – STP-MTRH-x*** Step Motors				
Dimensions (in [mm])*	Higher Torque Motors STP-MTRH-x			
	STP-MTRH-23079x	STP-MTRH-34066x	STP-MTRH-34097x	STP-MTRH-34127x
A	2.25 [57.2]	3.39 [86.1]		
B	1.86 [47.2]	2.74 [69.6]		
C	Ø 1.50 [38.1]	Ø 2.88 [73.0]		
D**	Ø 0.25 [6.4]	Ø 0.50 [12.7]		
E	Ø 0.20 [5.1] through	Ø 0.26 [6.6] through		
E ²	4-40	M2.5 x 0.45 thread		
E ³	n/a	M3 x 0.5 thread on a 1.73 in. bolt circle		
F ₁ **	3.10 [78.7]	2.64 [67.1]	3.82 [97.1]	5.00 [127.0]
F ₂ **	3.19 [81.0]	2.74 [67.1]	3.82 [97.1]	5.00 [127.0]
G ¹	0.906 [23]	n/a		
G ²	1.812 [46]			
G ³	n/a	1.22 [31]		
H ₁	0.81 [20.6]	1.46 [37.1]		
H ₂ **	0.51 [13]	1.13 [28.7]		
H ₃ **	0.40 [10.2]	n/a		
J**	0.59 [15.0]	0.98 [25.0]		
K**	0.23 [5.8]	0.45 [11.4]		
L	12 [305]			
Conductor	(4) #18 AWG			
Connector	(5) #18 AWG (for W motors)			
	Molex # 39-01-3042			
Pin	PXP4010/06S/6065 (for W motors)			
	Molex # 39-00-0039			
	Socket: SA3347 (for W motors)			

* mm dimensions are for reference purposes only.

** Dimension D (shaft diameter) is the same for both front and rear shafts of dual-shaft and encoder motors. Dimension H₂ applies only to dual-shaft (D) and encoder (E) motors. Dimensions J & K do NOT apply to rear shafts of dual-shaft and encoder motors (all rear shafts are round style). Dimension H₃ applies only to "E" models with the encoder pre-mounted. Dimension F₂ applies to "W" models only.

*** High bus voltage STP-MTRAC motors are shown in a separate table.

Typical Dimension & Cable Diagram for STP-MTRAC

STP-MTRAC-23xxx

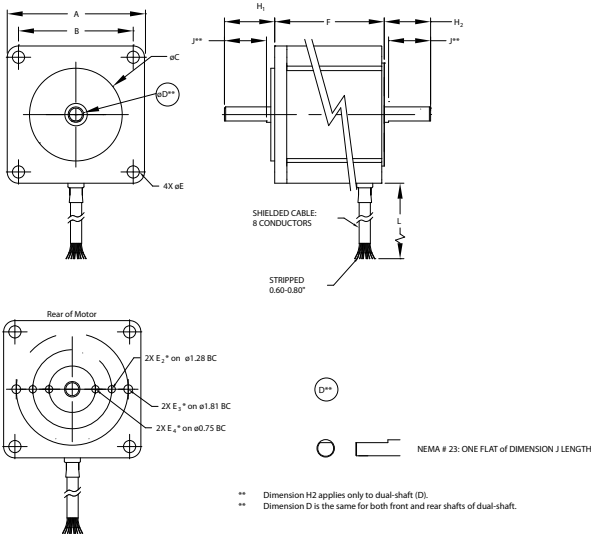

STP-MTRAC-34xxx

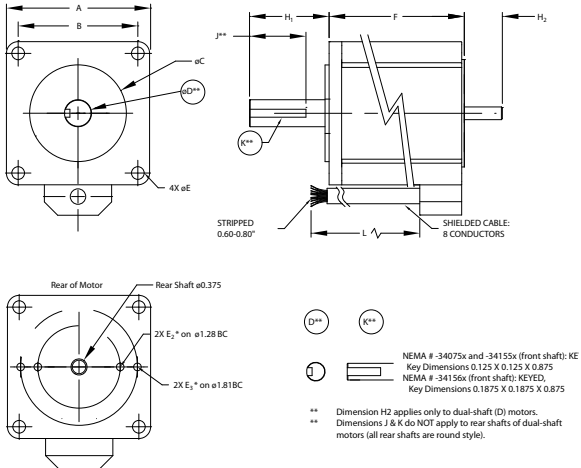

SureStep™ Series Dimensions & Cabling – STP-MTRAC-x Step Motors						
Dimensions (in [mm])*	High Bus Voltage Motors					
	STP-MTRAC -23044x	STP-MTRAC -23055x	STP-MTRAC -23078x	STP-MTRAC -34075x	STP-MTRAC -34115x	STP-MTRAC -34156x
A	2.25 [57.15]	2.25 [57.15]	2.25 [57.15]	3.39 [86.1]	3.39 [86.1]	3.39 [86.1]
B	1.86 [47.24]	1.86 [47.24]	1.86 [47.24]	2.74 [69.6]	2.74 [69.6]	2.74 [69.6]
C	1.50 [38.1]	1.50 [38.1]	1.50 [38.1]	2.87 [72.9]	2.87 [72.9]	2.87 [72.9]
D**	0.25 [6.35]	0.25 [6.35]	0.25 [6.35]	0.5 [12.7]	0.5 [12.7]	0.625 [15.9]
E	0.2 [5.08]	0.2 [5.08]	0.2 [5.08]	0.22 [5.59]	0.26 [6.6]	0.22 [5.59]
E ₂ ***	2-56 thru	2-56 thru	2-56 thru	2-56 UNC Tap 0.2 Deep	2-56 UNC Tap 0.2 Deep	2-56 UNC Tap 0.2 Deep
E ₃ ***	4-40 UNC x 0.2 Deep	4-40 UNC x 0.2 Deep	4-40 UNC x 0.2 Deep	4-40 UNC Tap 0.2 Deep	4-40 UNC Tap 0.2 Deep	4-40 UNC Tap 0.2 Deep
E ₄ ***	2-56 UNC Tap 0.2 Deep	2-56 UNC Tap 0.2 Deep	2-56 UNC Tap 0.2 Deep	–	–	–
F	1.71 [43.43]	2.16 [54.86]	3.05 [77.47]	2.95 [74.93]	4.52 [114.81]	6.14 [155.96]
H ₁	0.81 [20.57]	0.81 [20.57]	0.81 [20.57]	1.25 [31.75]	1.25 [31.75]	1.25 [31.75]
H ₂ ***	0.63 [16.0]	0.63 [16.0]	0.63 [16.0]	1.12 [28.45]	1.12 [28.45]	1.12 [28.45]
J	0.60 [15.24]	0.60 [15.24]	0.60 [15.24]	0.87 [22.1]	0.87 [22.1]	0.87 [22.1]
L	120 [3048]	120 [3048]	120 [3048]	120 [3048]	120 [3048]	120 [3048]
* mm dimensions are for reference purposes only.						
** Dimension D (shaft diameter) is the same for both front and rear shafts of NEMA 23 dual-shaft motors. See diagrams for NEMA 34.						
*** Dimension applies only to dual-shaft (D) motors.						

Typical Dimension & Cable Diagram for STP-MTRAC(H)-42x

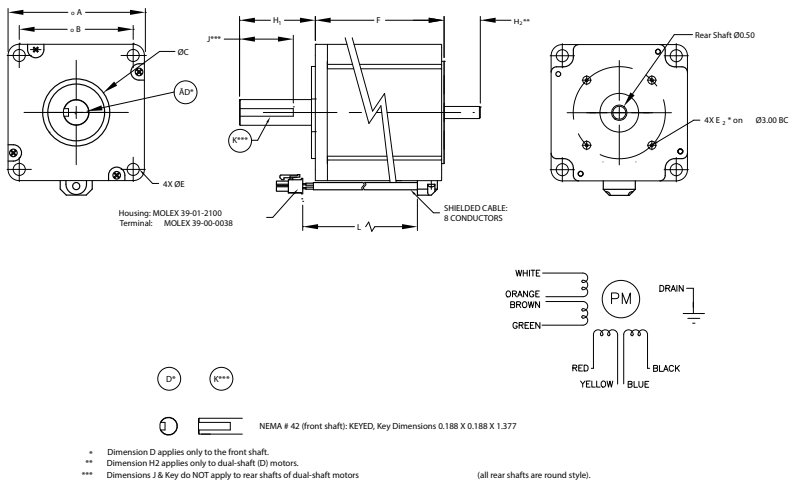

SureStep™ Series Dimensions & Cabling – STP-MTRAC(H)-42x Step Motors

Dimensions (in [mm])*	Higher Bus Voltage Motors					
	STP-MTRAC(H)-42100	STP-MTRAC(H)-42151	STP-MTRAC(H)-42202	STP-MTRAC(H)-42100D	STP-MTRAC(H)-42151D	STP-MTRAC(H)-42202D
A	4.33 [110]	4.33 [110]	4.33 [110]	4.33 [110]	4.33 [110]	4.33 [110]
B	3.50 [88.9]	3.50 [88.9]	3.50 [88.9]	3.50 [88.9]	3.50 [88.9]	3.50 [88.9]
C	2.19 [55.6]	2.19 [55.6]	2.19 [55.6]	2.19 [55.6]	2.19 [55.6]	2.19 [55.6]
D**	0.75 [19.05]	0.75 [19.05]	0.75 [19.05]	0.75 [19.05]	0.75 [19.05]	0.75 [19.05]
E	0.327 [8.31]	0.327 [8.31]	0.327 [8.31]	0.327 [8.31]	0.327 [8.31]	0.327 [8.31]
E ₂	n/a	n/a	n/a	4-40 UNC Tap 0.2 Deep	4-40 UNC Tap 0.2 Deep	4-40 UNC Tap 0.2 Deep
F	3.88	5.94	7.91	3.88***	5.94***	7.91***
H ₁	2.19 [55.6]	2.19 [55.6]	2.19 [55.6]	2.19 [55.6]	2.19 [55.6]	2.19 [55.6]
H ₂	n/a	n/a	n/a	1.12 [28.4]	1.12 [28.4]	1.12 [28.4]
J**	1.37 [34.8]	1.37 [34.8]	1.37 [34.8]	1.37 [34.8]	1.37 [34.8]	1.37 [34.8]
L	12 [305]					

* mm dimensions are for reference purposes only.

** Dimension D (shaft diameter), J, and Key do not apply to rear shafts of dual-shaft motors.

*** For encoder mounting the required STP-MTRA-42ENC will add 0.13 inches [3.2 mm] to the length of the motor.

Torque vs. Speed Charts

STP-MTR-14xxx(D) NEMA 14 Step Motors

STP-MTR-14026(x) Torque vs Speed (1.8° step motor; 1/2 stepping, RMS phase current)

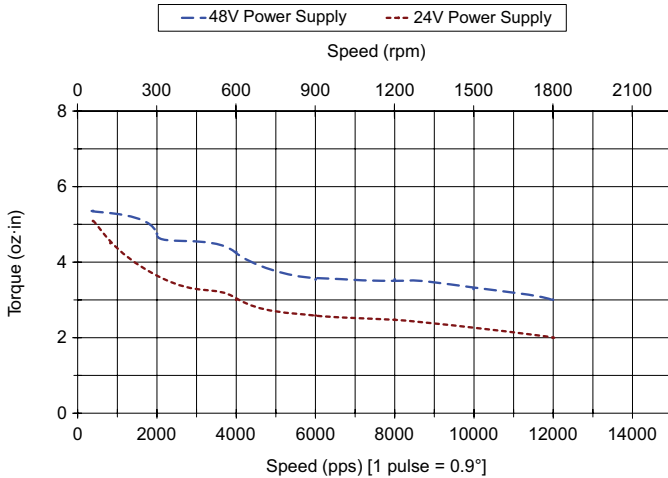

STP-MTR-14034(x) Torque vs Speed (1.8° step motor; 1/2 stepping, RMS phase current)

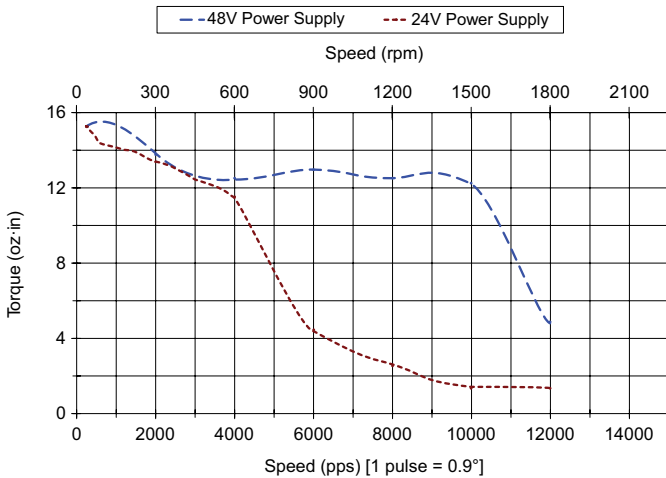

STP-MTR-17xxx(D) NEMA 17 Step Motors

Note: "W" series motors have 5% less running torque than other models.

STP-MTR-17040x Torque vs Speed (1.8° step motor; 1/2 stepping, RMS phase current)

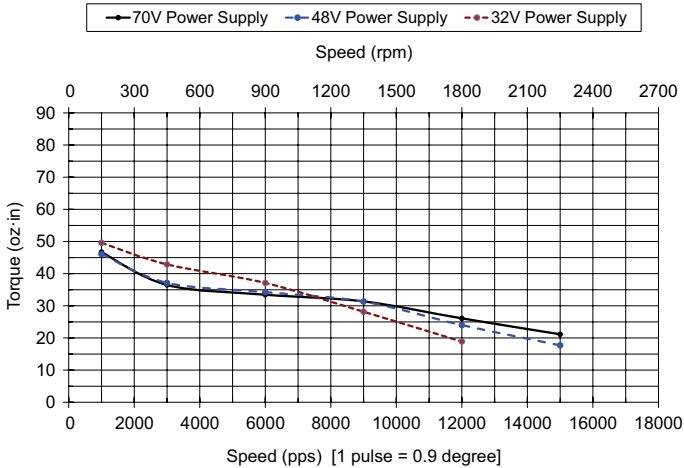

STP-MTR-17048x Torque vs Speed (1.8° step motor; 1/2 stepping, RMS phase current)

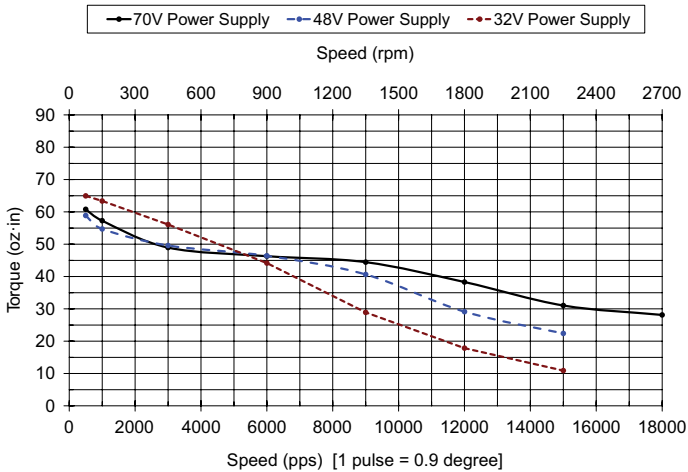

Torque vs. Speed Charts (continued)

Note: "W" series motors have 5% less running torque than other models.

STP-MTR-17xxx(D) NEMA 17 Step Motors (continued)

STP-MTR-17060x Torque vs Speed (1.8° step motor; 1/2 stepping, RMS phase current)

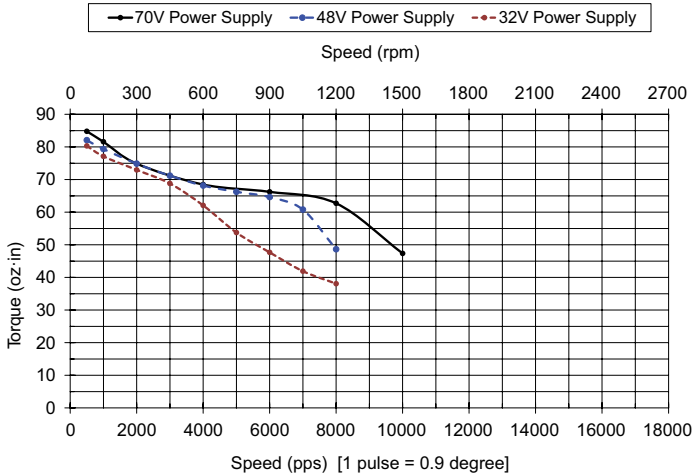

STP-MTR(H)-23xxx(D) NEMA 23 Step Motors

STP-MTR-23055x Torque vs Speed (1.8° step motor; 1/2 stepping, RMS phase current)

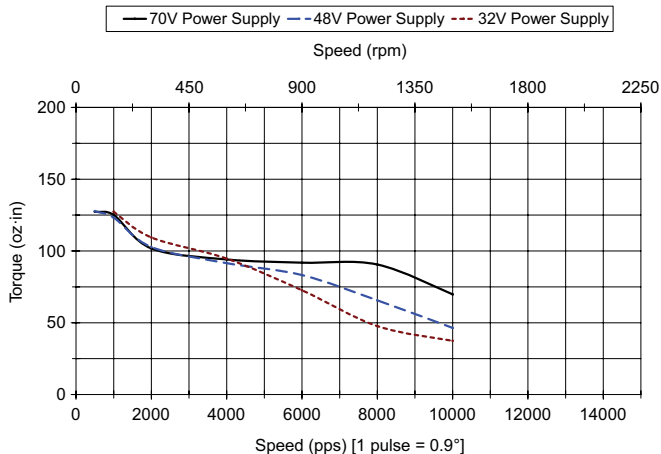

Torque vs. Speed Charts (continued)

Note: "W" series motors have 5% less running torque than other models.

STP-MTR(H)-23xxx(D) NEMA 23 Step Motors (continued)

STP-MTR-23079x Torque vs Speed (1.8° step motor; 1/2 stepping, RMS phase current)

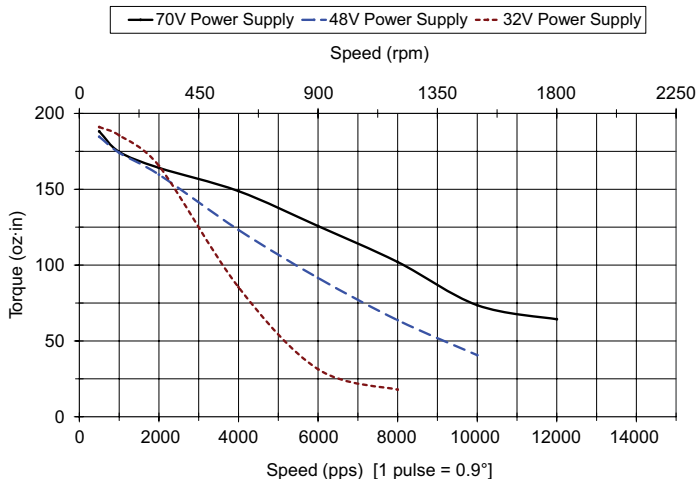

STP-MTRH-23079x Torque vs Speed (1.8° step motor; 1/2 stepping, RMS phase current)

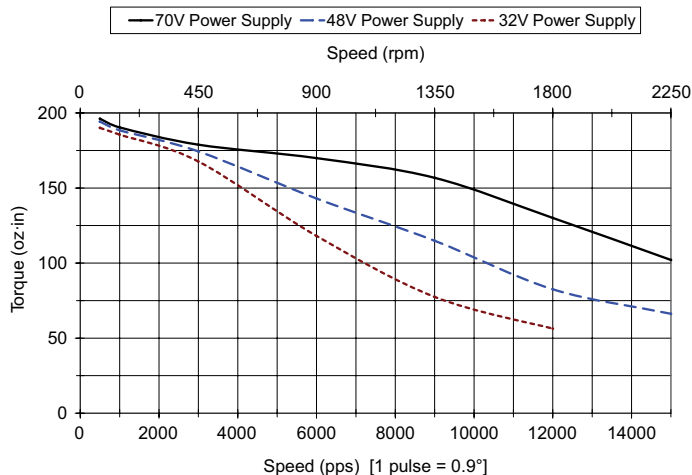

Torque vs. Speed Charts (continued)

Note: "W" series motors have 5% less running torque than other models.

STP-MTR(H)-34xxx(D) NEMA 34 Step Motors

STP-MTR-34066x Torque vs Speed (1.8° step motor; 1/2 stepping, RMS phase current)

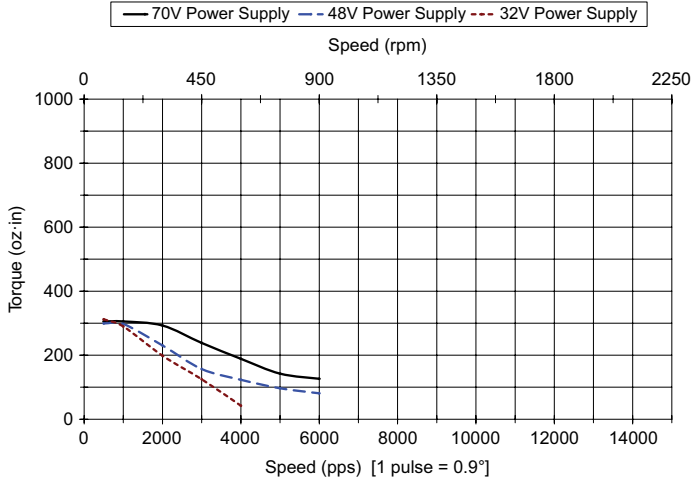

STP-MTRH-34066x Torque vs Speed (1.8° motor; 1/2 stepping, RMS phase current)

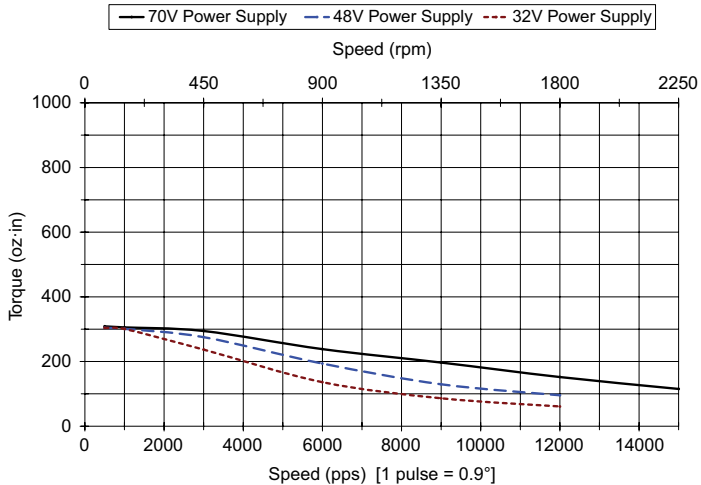

Torque vs. Speed Charts (continued)

Note: "W" series motors have 5% less running torque than other models.

STP-MTR(H)-34xxx(D) NEMA 34 Step Motors (continued)

STP-MTRH-34097x Torque vs Speed (1.8° step motor; 1/2 stepping, RMS phase current)

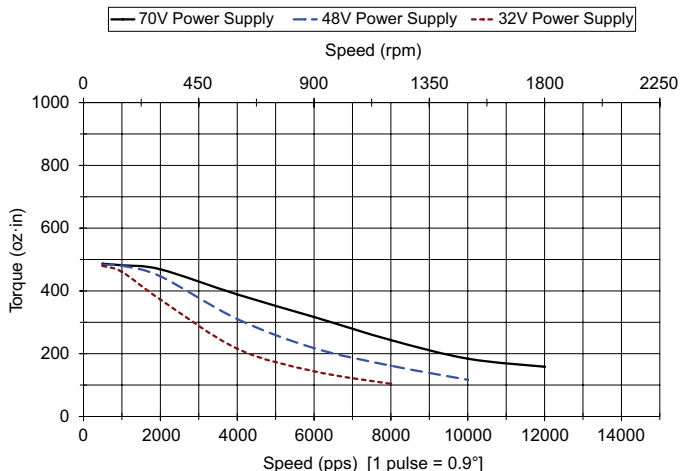

STP-MTRH-34127x Torque vs Speed (1.8° step motor; 1/2 stepping, RMS phase current)

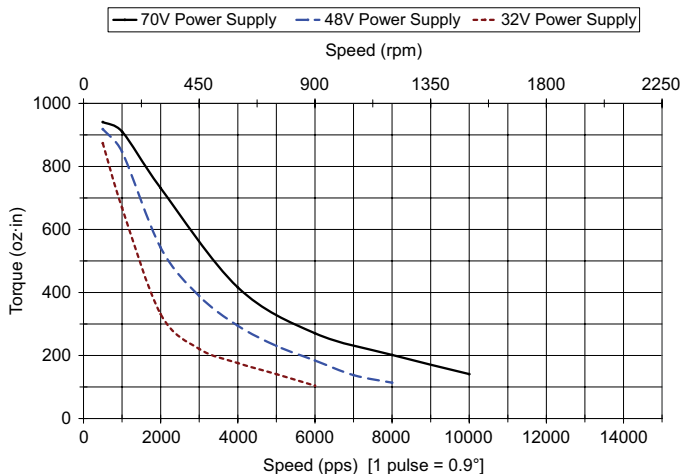

Torque vs. Speed Charts (continued)

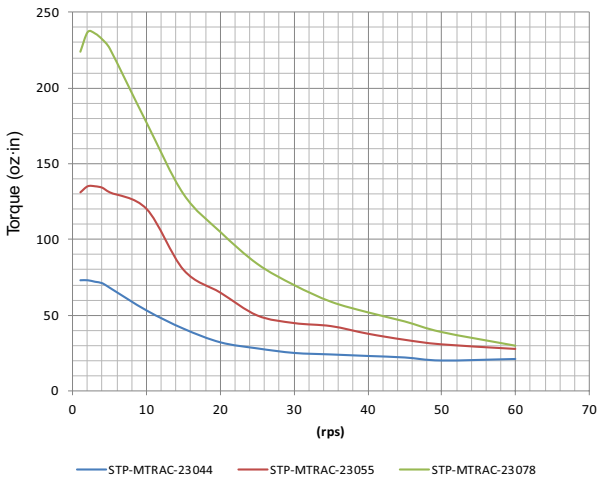
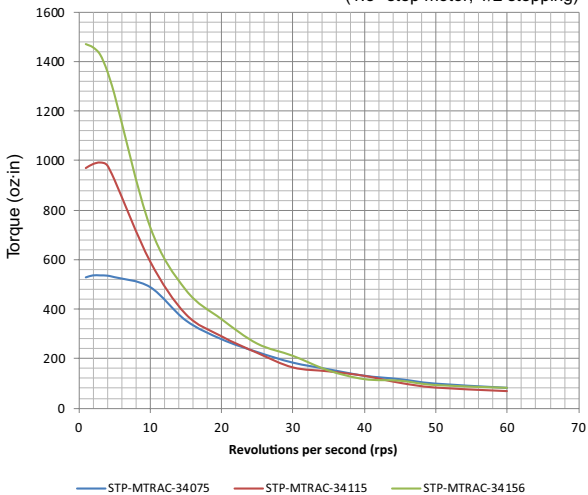
STP-MTRAC-23xxxx Torque vs Speed @ 340VDC bus
(1.8° step motor; 1/2 stepping)STP-MTRAC-34xxxx Torque vs Speed @ 340VDC bus
(1.8° step motor; 1/2 stepping)

For NEMA 42 charts:
 “S” = Bipolar Series
 “P” = Bipolar Parallel

Torque vs. Speed Charts (continued)

STP-MTRAC-42100x 24/48 VDC

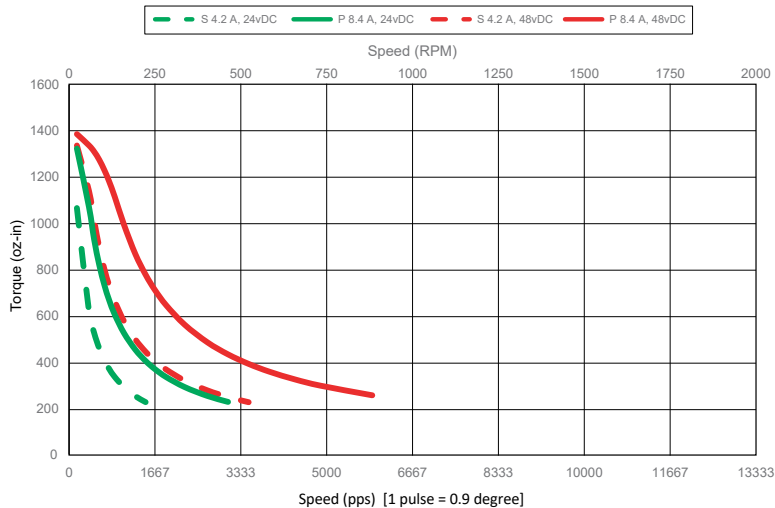

STP-MTRAC-42100x 72/160VDC

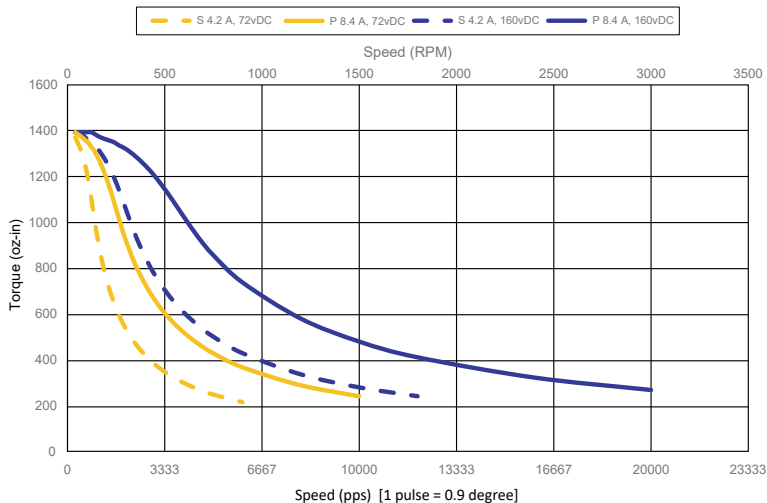

For NEMA 42 charts:
 “S” = Bipolar Series
 “P” = Bipolar Parallel

Torque vs. Speed Charts (continued)

STP-MTRAC-42151x 24/48 VDC

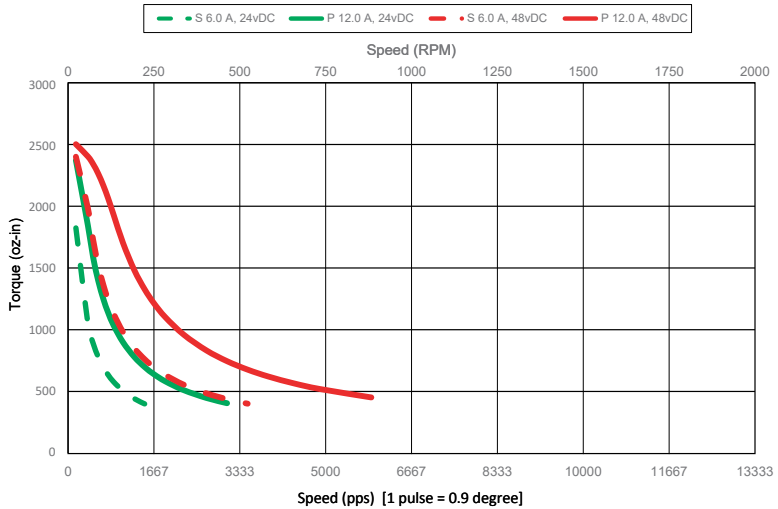

STP-MTRAC-42151x 72/160VDC

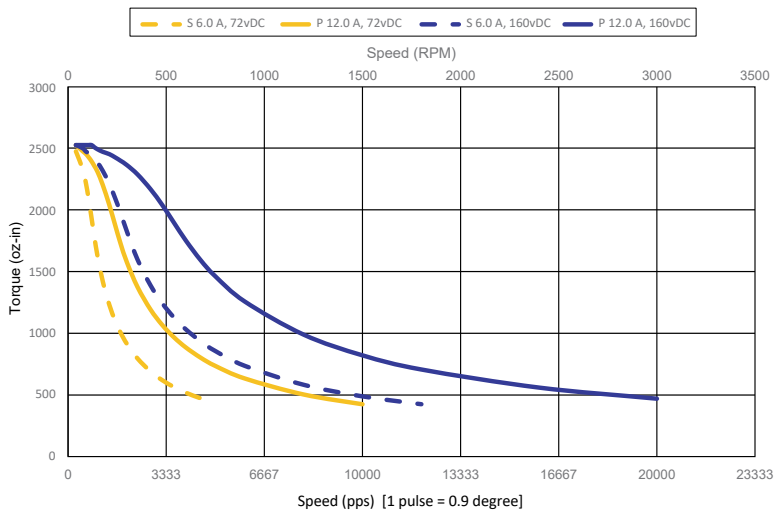

For NEMA 42 charts:
 “S” = Bipolar Series
 “P” = Bipolar Parallel

Torque vs. Speed Charts (continued)

STP-MTRAC-42202x 24/48 VDC

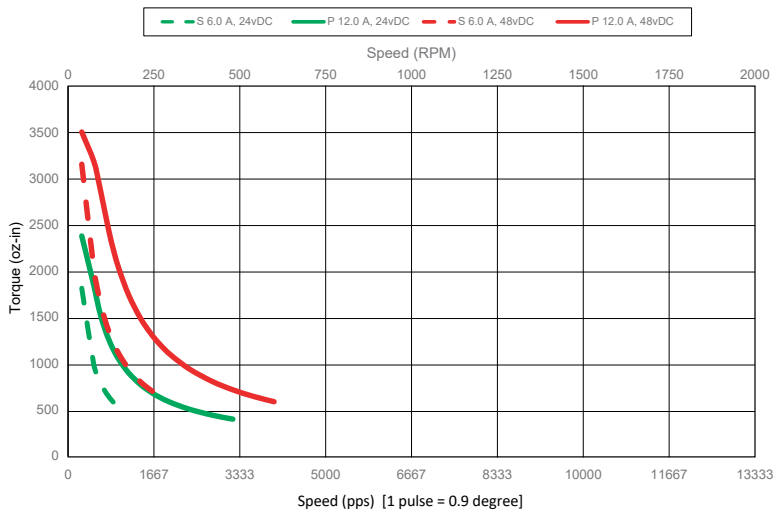

STP-MTRAC-42202x 72/160VDC

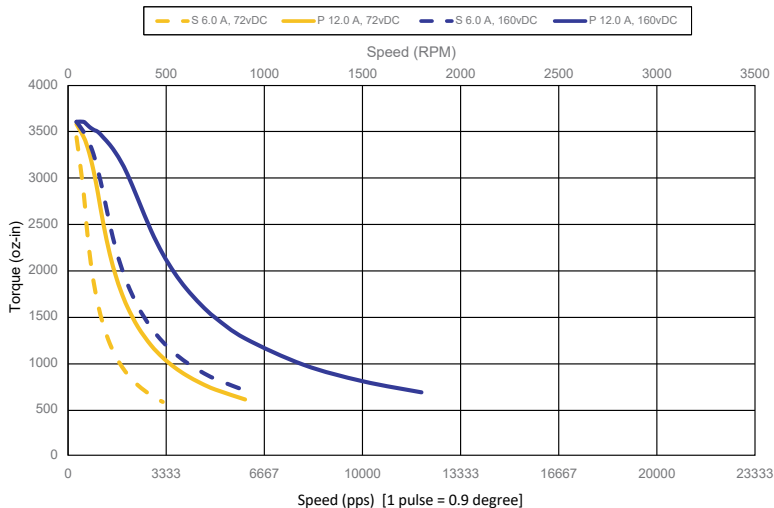

For NEMA 42 charts:
 “S” = Bipolar Series
 “P” = Bipolar Parallel

Torque vs. Speed Charts (continued)

STP-MTRACH-42100x 24/48 VDC

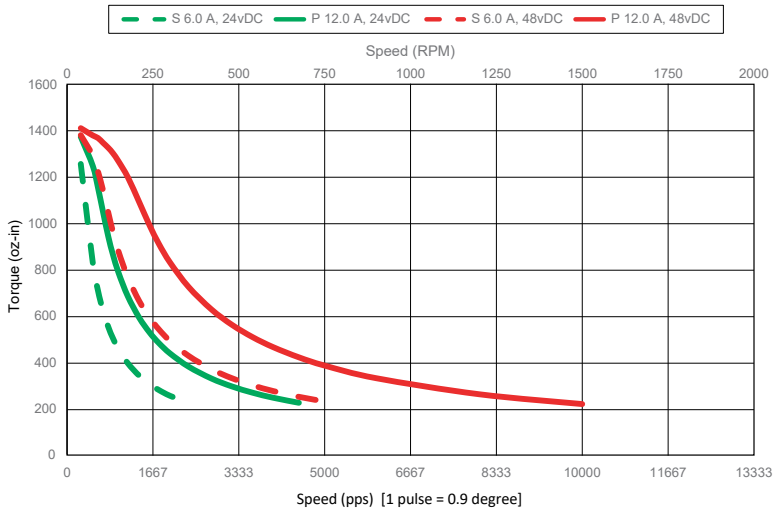

STP-MTRACH-42100x 72/160VDC

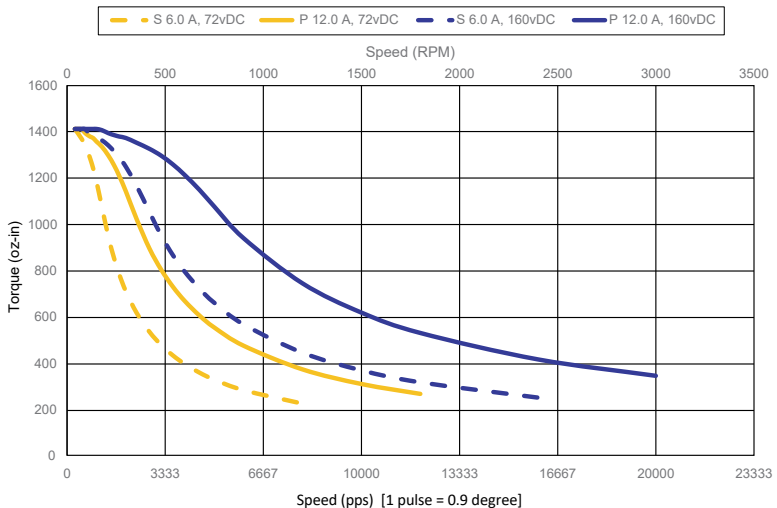

For NEMA 42 charts:
 “S” = Bipolar Series
 “P” = Bipolar Parallel

Torque vs. Speed Charts (continued)

STP-MTRACH-42151x 24/48 VDC

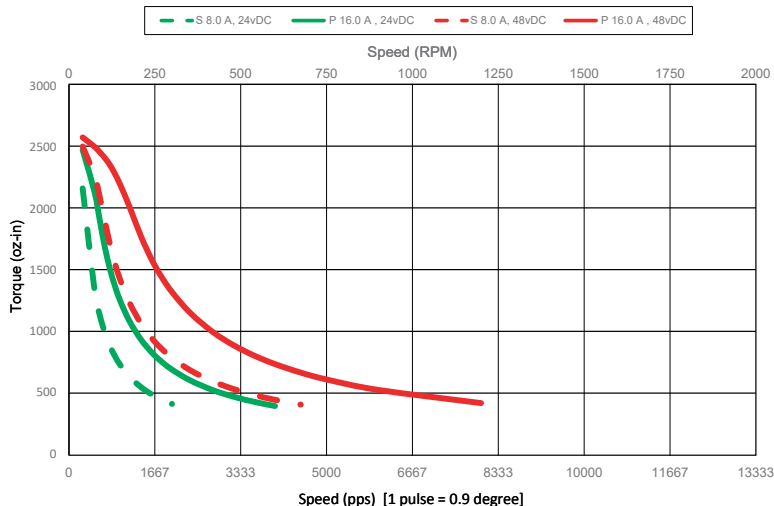

STP-MTRACH-42151x 72/160VDC

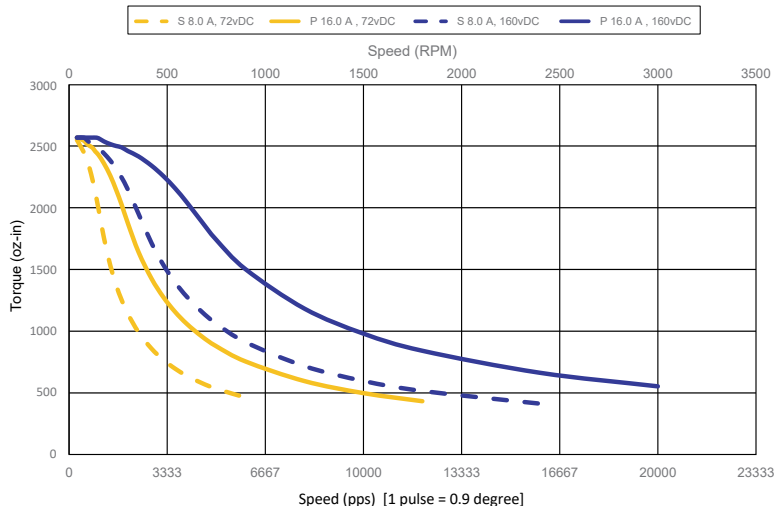

For NEMA 42 charts:
 “S” = Bipolar Series
 “P” = Bipolar Parallel

Torque vs. Speed Charts (continued)

STP-MTRACH-42202x 24/48 VDC

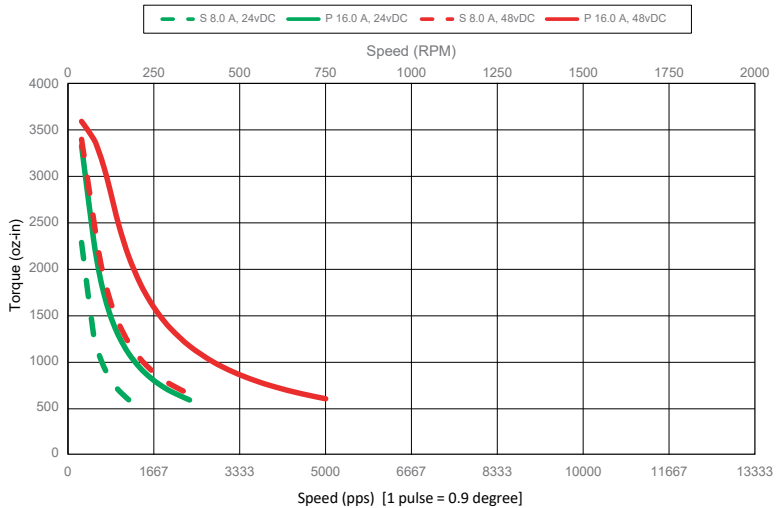

STP-MTRACH-42202x 72/160VDC

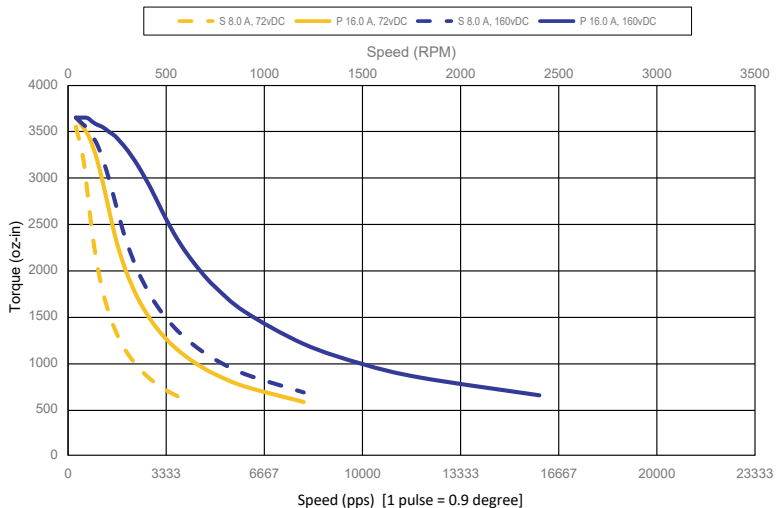

BLANK
PAGE

SURESTEP™
LINEAR ACTUATORS



CHAPTER
8

In This Chapter...

Features	8-2
Design and Installation Tips.....	8-3
Model Number Explanation	8-3
Specifications	8-4
Power Supply and Step Motor Drive	8-8
Mounting the Motor	8-8
Journal Mounting	8-8
Connecting the Motor	8-10
Extension Cable Wiring Diagrams	8-10
Motor Dimensions and Cabling	8-12
Thrust vs. Speed Charts.....	8-16

Features

- Stepper Linear Actuators available in NEMA 17 and NEMA 23 motor frame sizes.
- Square frame style produces high torque and achieves best torque to volume ratio.
- Linear forces up to 193lbs
- Linear speeds up to 19 in/sec
- Available in single-shaft and dual-shaft configurations.
- Lead Screws are cold-finished stainless steel (SUS303Cu).
- Nuts are PTFE-infused polymer (TECFORM AD AF) and require no lubrication.
- Dual shaft models are encoder ready (pretapped holes ready for modular encoder mounting).
- Dual shaft models have machined journals and grooves for bearing and retaining ring mounting.
- Three lead screw lengths of 6, 9, and 12 inches
- Nine different lead pitches from 1.25 mm/rev to 1 inch/rev
- Optional 6, 10, or 20 foot extension cable with locking connector available.
- Replacement triangular nuts and round nuts available.

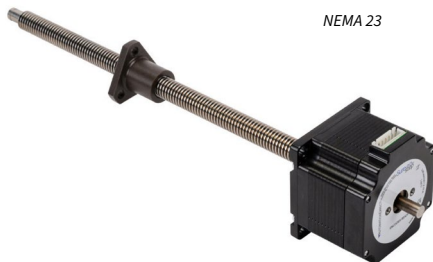
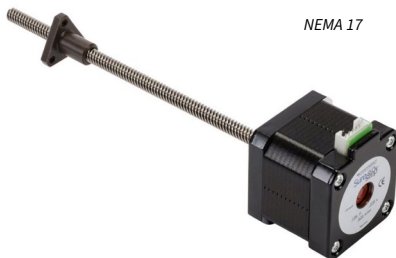

Design and Installation Tips

Allow sufficient time to accelerate the load and size the step motor with a 100% torque safety factor (i.e.: design the system using a maximum of 50% of the motor's torque). DO NOT disassemble lead screw step motors, as motor performance will be reduced and the warranty will be voided. DO NOT connect or disconnect the step motor during operation.

The motor can be mounted in any orientation (horizontal or vertical). There can be slight backlash when mounting in a horizontal application. Most vertical applications will not be subjected to any noticeable backlash. In horizontal applications do not apply any appreciable overhung load to the screw. If the load causes more than 0.0025" of deflection per inch of lead screw, support the end of the screw with a sleeve, bushing or bearing. In vertical applications securing the end of the screw may not be needed. Mount it to a surface with good thermal conductivity, such as steel or aluminum, to allow heat dissipation.

In general, the higher the current into a step motor the higher the torque, especially at lower speeds. The higher the voltage to the step motor, the higher the torque at higher speeds. Losses come in to play here, too. The higher you run the current on the motors, the higher your losses are going to be, and the hotter your motors are going to get. For this reason, Automation Direct specs current for motors at the RMS value. This is the value on the motor's label and specification table. This guarantees a very long life for the motor. Multiplying the motor's RMS phase current by 1.2 gives a good balance of rotary torque (linear thrust of the actuator) vs loss. This value should then be used to set the drive's peak phase current. Note that the whole speed thrust curve won't be shifted up, only the low speed flat part before the torque starts dropping. The curve can drop for many reasons, but typically it's due to not having enough voltage to push the desired current into the windings, so increasing the voltage is what gives you a boost there, not making more current available.

Model Number Explanation

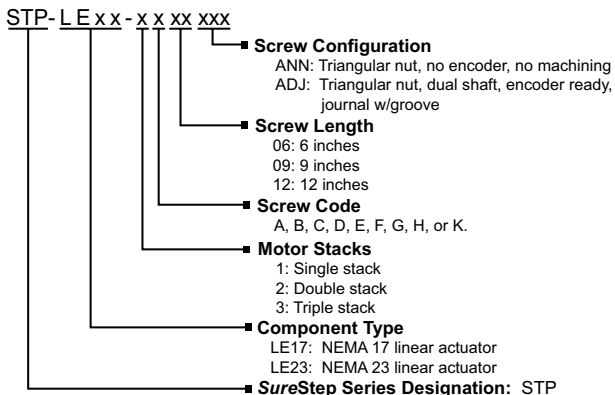

Specifications

The tables below reference the specifications for all the SureStep Linear Actuators sold by AutomationDirect. Click the location link to go directly to the spec table.

Model Number	Lead (per rev)	Nominal Thrust (@150RPM)	Motor Weight (lbs)	Specifications Location
STP-LE17-2A06ANN	0.25"	45lbs	0.7	Table 1, STP-LE17-2Axxxxx
STP-LE17-2A09ANN			0.8	
STP-LE17-2A12ANN			0.9	
STP-LE17-2A06ADJ			0.7	
STP-LE17-2A09ADJ			0.8	
STP-LE17-2A12ADJ			0.9	
STP-LE17-3A06ANN	0.25"	69lbs	0.9	Table 1, STP-LE17-3Axxxxx
STP-LE17-3A09ANN			1.1	
STP-LE17-3A12ANN			1.3	
STP-LE17-3A06ADJ			0.9	
STP-LE17-3A09ADJ			1.1	
STP-LE17-3A12ADJ			1.3	
STP-LE17-3B06ANN	0.5"	38lbs	0.9	Table 1, STP-LE17-3Bxxxxx
STP-LE17-3B09ANN			1.1	
STP-LE17-3B12ANN			1.3	
STP-LE17-3B06ADJ			0.9	
STP-LE17-3B09ADJ			1.1	
STP-LE17-3B12ADJ			1.3	
STP-LE17-2C06ANN	3mm	73lbs	0.7	Table 1, STP-LE17-2Cxxxxx
STP-LE17-2C09ANN			0.8	
STP-LE17-2C12ANN			0.9	
STP-LE17-2C06ADJ			0.7	
STP-LE17-2C09ADJ			0.8	
STP-LE17-2C12ADJ			0.9	

Model Number	Lead (per rev)	Nominal Thrust (@150RPM)	Motor Weight (lbs)	Specifications Location
STP-LE17-2D06ANN	1.25 mm	87lbs	0.8	Table 1, STP-LE17-2Dxxxx
STP-LE17-2D09ANN			0.9	
STP-LE17-2D12ANN			1.0	
STP-LE17-2D06ADJ			0.8	
STP-LE17-2D09ADJ			0.9	
STP-LE17-2D12ADJ			1.0	
STP-LE17-3E06ANN	8mm	55lbs	1.0	Table 1, STP-LE17-3Exxxx
STP-LE17-3E09ANN			1.2	
STP-LE17-3E12ANN			1.4	
STP-LE17-3E06ADJ			1.0	
STP-LE17-3E09ADJ			1.2	
STP-LE17-3E12ADJ			1.4	
STP-LE23-1F06ANN	10.5 mm	63lbs	1.4	Table 2, STP-LE23-1Fxxxx
STP-LE23-1F09ANN			1.6	
STP-LE23-1F12ANN			1.8	
STP-LE23-1F06ADJ			1.4	
STP-LE23-1F09ADJ			1.6	
STP-LE23-1F12ADJ			1.8	
STP-LE23-1G06ANN	2mm	137lbs	1.4	Table 2, STP-LE23-1Gxxxx
STP-LE23-1G09ANN			1.7	
STP-LE23-1G12ANN			2.0	
STP-LE23-1G06ADJ			1.4	
STP-LE23-1G09ADJ			1.7	
STP-LE23-1G12ADJ			2.0	
STP-LE23-1H06ANN	6mm	87lbs	1.4	Table 2, STP-LE23-1Hxxxx
STP-LE23-1H09ANN			1.7	
STP-LE23-1H12ANN			2.0	
STP-LE23-1H06ADJ			1.4	
STP-LE23-1H09ADJ			1.7	
STP-LE23-1H12ADJ			2.0	

Model Number	Lead (per rev)	Nominal Thrust (@150RPM)	Motor Weight (lbs)	Specifications Location
STP-LE23-3H06ANN	6mm	193lbs	2.7	Table 2, STP-LE23-3Hxyyy
STP-LE23-3H09ANN			3.0	
STP-LE23-3H12ANN			3.3	
STP-LE23-3H06ADJ			2.7	
STP-LE23-3H09ADJ			3.0	
STP-LE23-3H12ADJ			3.3	
STP-LE23-3K06ANN	1"	62lbs	2.7	Table 2, STP-LE23-3KxxAyy
STP-LE23-3K09ANN			3.0	
STP-LE23-3K12ANN			3.3	
STP-LE23-3K06ADJ			2.7	
STP-LE23-3K09ADJ			3.0	
STP-LE23-3K12ADJ			3.3	

Table 1: NEMA 17 Linear Actuator Specifications

SureStep™ Series Specifications – Linear Actuator Stepping Motors						
Linear Actuator Motors	STP-LE17-2Axyyy	STP-LE17-2Cxyyy	STP-LE17-2Dxyyy	STP-LE17-3Axyyy	STP-LE17-3Bxyyy	STP-LE17-3Exxyy
NEMA	17					
Phases	2					
Rated Current	2A					
Phase Resistance	1.04 Ω ± 10% (@20°C)			1.25 Ω ± 15% (@20°C)		
Phase Inductance	2.5 mH ± 20% (1kHz 1V rms)			2.8 mH ± 20% (1kHz 1V rms)		
Rotor Inertia	57 g·cm ²			82 g·cm ²		
Rotational Shaft Holding Torque	0.46 N·m (65.14 oz-in)			0.63 N·m (89.21 oz-in)		
No. of Motor Stacks	2			3		
Motor Length	39.8 mm			48.3 mm		
Screw Material	SUS303Cu (cold-finished stainless steel)					
Nut Material	TECAFORM AD AF (PTFE-infused polymer)					
Lead	0.25"/rev	3mm/rev	1.25 mm/rev	0.25"/rev	0.5"/rev	8mm/rev
Linear Travel/Step (1.8°)	0.00125 in/step	0.015 mm/step	0.00625 mm/step	0.00125 in/step	0.0025 in/step	0.04 mm/step
Linear Speed ¹ (@150rpm)	0.6250 in/sec	7.5 mm/sec	3.125 mm/sec	0.625 in/sec	1.25 in/sec	20 mm/sec
Thrust (@150rpm)	45lbs	73lbs	87lbs	69lbs	38lbs	55lbs
Load Limit (lbs) ²	75	75	80	75	75	80
Radial Deflection (Max) ³	6" lead screw: 0.015" 9" lead screw: 0.0225" 12" lead screw: 0.03"					
Ambient Operating Temperature	-20-50°C					
Insulation Class	B (130°C)					
Screw Diameter	0.25"	6.5 mm	8mm	0.25"	0.25"	8mm
Agency Approvals	CE					
1	To determine your linear speed as it relates to RPM use the following formula: Linear Speed = RPM x (Lead/60 sec)					
2	The load limit indicates max load before the nut lifespan is negatively impacted, not what the linear actuator can move.					
3	Calculated deflection is the deflection value measured at the end of the lead screw.					
Note:	For dual-shaft motors (STP-LExx-xxxADJ series) the sum of the front and rear torque loads, radial loads, and thrust loads must not exceed the applicable torque, radial and thrust load ratings of the motor.					

Table 2: NEMA 23 Linear Actuator Specifications

SureStep™ Series Specifications – Connectorized Bipolar Stepping Motors					
Linear Actuator Motors	STP-LE23-1Fxyyy	STP-LE23-1Hxyyy	STP-LE23-1Gxyyy	STP-LE23-3Kxyyy	STP-LE23-3Hxyyy
NEMA	23				
Phases	2				
Rated Current	2.1 A			3A	
Phase Resistance	1.6 Ω ± 10% (@20°C)			1.1 Ω ± 10% (@20°C)	
Phase Inductance	3.9 mH ± 20% (1kHz 1V rms)			5.0 mH ± 20% (1kHz 1V rms)	
Rotor Inertia	180 g·cm ²			460 g·cm ²	
Rotational Shaft Holding Torque	0.9 N·m (127.45 oz-in)			2.3 N·m (325.70 oz-in)	
No. of Motor Stacks	1			3	
Motor Length	45mm			79mm	
Screw Material	SUS303Cu (cold-finished stainless steel)				
Nut Material	TECAFORM AD AF (PTFE-infused polymer)				
Lead	10.5 mm/rev	6mm/rev	2mm/rev	1"/rev	6mm/rev
Linear Travel/Step (1.8°)	0.0525 mm/step	0.03 mm/step	0.01 mm/step	0.005 in/step	0.03 mm/step
Linear Speed ¹ (@150rpm) ²	26.25 mm/sec	15 mm/sec	5 mm/sec	2.5 in/sec	15 mm/sec
Thrust (@150rpm) ²	63lbs	87lbs	137lbs	62lbs	193lbs
Load Limit (lbs) ³	100	175	175	175	175
Radial Deflection (Max) ⁴	6" lead screw: 0.015" 9" lead screw: 0.0225" 12" lead screw: 0.03"				
Ambient Operating Temperature	-20-50°C				
Insulation Class	B (130°C)				
Screw Diameter	10mm	12mm	12mm	0.5"	12mm
Agency Approvals	CE				
1	To determine your linear speed as it relates to RPM use the following formula: Linear Speed = RPM x (Lead/60 sec)				
2	For STP-LE23-3KxxAyy and STP-LE23-3HxxAyy series motors, nominal speed and thrust values are provided for operation at 120rpm rather than 150rpm.				
3	The load limit indicates max load before the nut lifespan is negatively impacted, not what the linear actuator can move.				
4	Calculated deflection is the deflection value measured at the end of the lead screw.				
Note:	For dual-shaft motors (STP-LExx-xxxADJ series) the sum of the front and rear torque loads, radial loads, and thrust loads must not exceed the applicable torque, radial and thrust load ratings of the motor.				

Power Supply and Step Motor Drive

An STP-PWR-xxxx linear power supply from AutomationDirect is the best choice to power AutomationDirect and other DC-input stepper drives. These power supplies were designed to work with the AutomationDirect SureStep™ STP-DRV-xxxx series bipolar DC microstepping motor drives. PSBxx switching power supplies are also available from AutomationDirect.

Always check the motor specs and speed-torque curves to determine allowable drive input voltage. To minimize heat loss in the motor, always choose the lowest input voltage that satisfies the application's speed-torque requirements.

Mounting the Motor

We recommend mounting the motor to a metallic surface to help dissipate heat generated by the motor.

Journal Mounting

Below is a list of mounting components that are compatible with the NEMA17 and NEMA23 journal machined end (ADJ) motors. These are not sold by Automaton Direct but McMasterCarr part numbers have been given as an example. This list is not a suggested solution for your application as it may not be suitable. These are for securing the end of the lead screw so it does not move in the radial plane and to provide radial support of the lead screw and load. The bearings in the motor are designed to handle the axial loads not the bearing securing the journal end. The axial load forces should not exceed the force determined by the Speed Force curve for each model.



NOTE: Some of the smaller NEMA 17 lead screws have journals and rear shafts with threads still visible in the machined area. This occurs on screw codes A, B, and C. This is done to maintain minimum shaft diameter. Bearings, bushings, and motor-mounted encoders will still work correctly on the grooved journals. The journal ends do still have a groove for a retaining clip, but may be hard to see.



Journal end with visible threads



Standard journal end

NEMA Rating	Part Number	Description	Quantity
17	98541A113	Retainer for 5mm shaft	1
	6153K69	5mm ID bearing	1
	92161A025	5mm ID wave washer	2
	98089A331	5mm ID x 0.5 mm thick shim	1
23	90967A120	Retainer for 8mm shaft	1
	6661K820	8mm ID bearing	1
	90134A030	5/16" ID wave washer	1
	98089A136	8mm ID x 0.5 mm thick shim	1

STP-LE17-xxxxADJ Journal Mounting

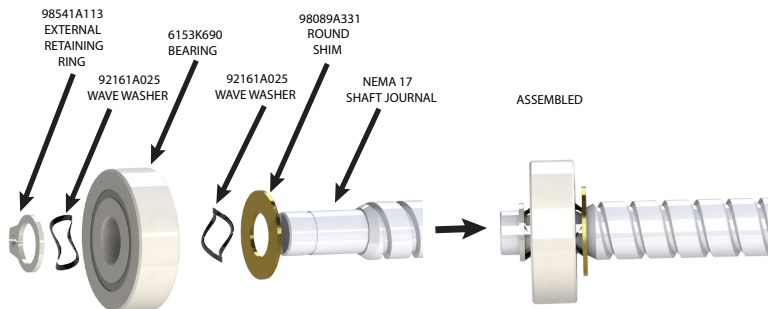

STP-LE23-xxxxADJ Journal Mounting

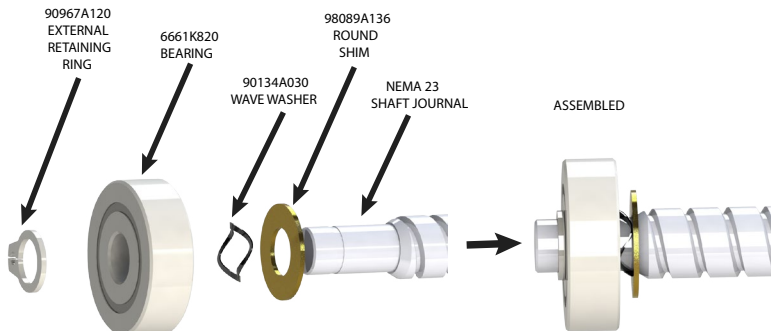

Connecting the Motor



WARNING: When connecting a step motor to a drive or indexer, be sure that the motor power supply is switched off. Never disconnect the motor while the drive is powered up. Never connect the motor leads to ground or directly to the power supply.

All SureStep step STP-MTR series motors have connectorized cables which connect directly to available SureStep extension cables. STP-LA-EXT17-x cables fit the NEMA17 lead screw motors and the STP-LA-EXT23-x cables fit the NEMA 23 lead screw motors.

Extension Cable Wiring Diagrams

STP-LA-EXT17-0xx Dimensions (mm [in])

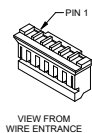
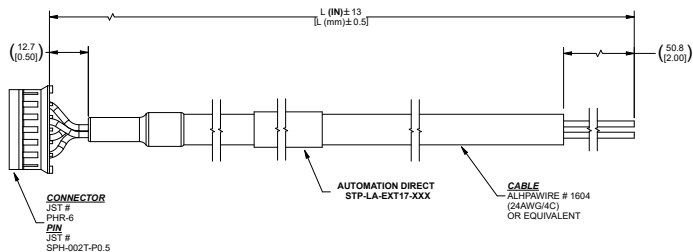

PIN #	COLOR	WIRE
1	RED	A+
2	N/A	
3	YELLOW	A-
4	GREEN	B+
5	N/A	
6	BLACK	B-

CABLES		
CABLE PART #	LENGTH L (IN)	LENGTH L (mm)
STP-LA-EXT17-006	72	1828
STP-LA-EXT17-010	120	3048
STP-LA-EXT17-020	240	6096

STP-LA-EXT23-0xx Dimensions (mm [in])

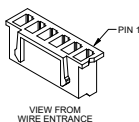
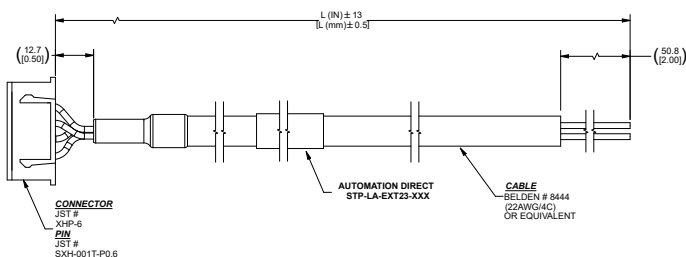

PIN #	COLOR	WIRE
1	RED	A+
2	N/A	
3	WHITE	A-
4	GREEN	B+
5	N/A	
6	BLACK	B-

CABLES		
CABLE PART #	LENGTH L (IN)	LENGTH L (mm)
STP-LA-EXT23-006	72	1828
STP-LA-EXT23-010	120	3048
STP-LA-EXT23-020	240	6096

Motor Dimensions and Cabling

STP-LE17-xxANN

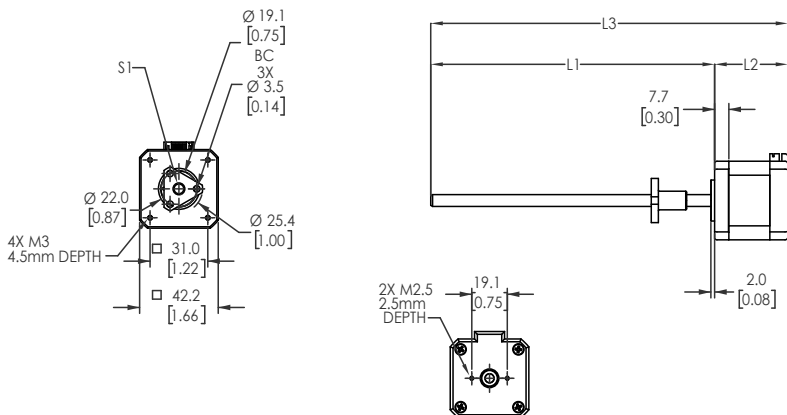

STP-LE17-xxANN Dimensions (mm [in])

Part #	L1	L2	L3	S1
STP-LE17-2A06ANN	152.4 [6.00]	39.3 [1.55]	191.7 [7.55]	6.4 [0.25] 0.25" Lead
STP-LE17-2A09ANN	228.6 [9.00]	39.3 [1.55]	267.9 [10.55]	6.4 [0.25] 0.25" Lead
STP-LE17-2A12ANN	304.8 [12.00]	39.3 [1.55]	344.1 [13.55]	6.4 [0.25] 0.25" Lead
STP-LE17-2C06ANN	152.4 [6.00]	39.3 [1.55]	191.7 [7.55]	6.5 [0.47] 3.0 mm Lead
STP-LE17-2C09ANN	228.6 [9.00]	39.3 [1.55]	267.9 [10.55]	6.5 [0.47] 3.0 mm Lead
STP-LE17-2C12ANN	304.8 [12.00]	39.3 [1.55]	344.1 [13.55]	6.5 [0.47] 3.0 mm Lead
STP-LE17-2D06ANN	152.4 [6.00]	39.3 [1.55]	191.7 [7.55]	8.0 [0.31] 1.25 mm Lead
STP-LE17-2D09ANN	228.6 [9.00]	39.3 [1.55]	267.9 [10.55]	8.0 [0.31] 1.25 mm Lead
STP-LE17-2D12ANN	304.8 [12.00]	39.3 [1.55]	344.1 [13.55]	8.0 [0.31] 1.25 mm Lead
STP-LE17-3A06ANN	152.4 [6.00]	47.8 [1.88]	200.2 [7.88]	6.4 [0.25] 0.25" Lead
STP-LE17-3A09ANN	228.6 [9.00]	47.8 [1.88]	276.4 [10.88]	6.4 [0.25] 0.25" Lead
STP-LE17-3A12ANN	304.8 [12.00]	47.8 [1.88]	352.6 [13.88]	6.4 [0.25] 0.25" Lead
STP-LE17-3B06ANN	152.4 [6.00]	47.8 [1.88]	200.2 [7.88]	6.4 [0.25] 0.5" Lead
STP-LE17-3B09ANN	228.6 [9.00]	47.8 [1.88]	276.4 [10.88]	6.4 [0.25] 0.5" Lead
STP-LE17-3B12ANN	304.8 [12.00]	47.8 [1.88]	352.6 [13.88]	6.4 [0.25] 0.5" Lead
STP-LE17-3E06ANN	152.4 [6.00]	47.8 [1.88]	200.2 [7.88]	8.0 [0.31] 8.0 mm Lead
STP-LE17-3E09ANN	228.6 [9.00]	47.8 [1.88]	276.4 [10.88]	8.0 [0.31] 8.0 mm Lead
STP-LE17-3E12ANN	304.8 [12.00]	47.8 [1.88]	352.6 [13.88]	8.0 [0.31] 8.0 mm Lead

STP-LE17-xxADJ

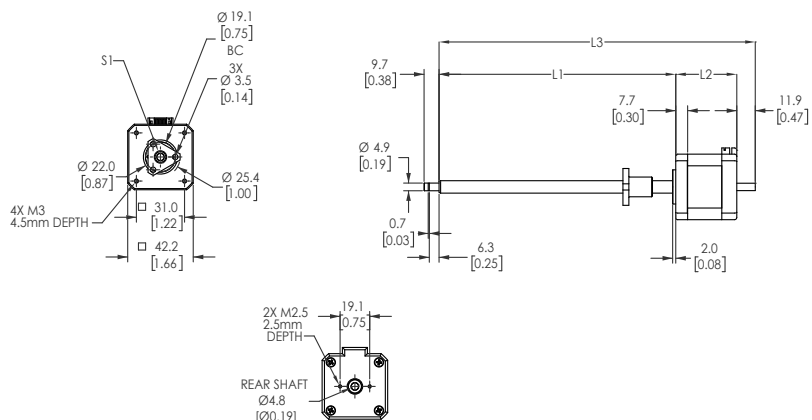

STP-LE17-xxADJ Dimensions (mm [in])

Part #	L1	L2	L3	NA	NB	S1
STP-LE17-2A06ADJ	152.4 [6.00]	39.3 [1.55]	203.6 [8.02]	19.0 [0.75]	10.0 [0.39]	6.4 [0.25] 0.25" Lead
STP-LE17-2A09ADJ	228.6 [9.00]	39.3 [1.55]	279.8 [11.02]	19.0 [0.75]	10.0 [0.39]	6.4 [0.25] 0.25" Lead
STP-LE17-2A12ADJ	304.8 [12.00]	39.3 [1.55]	356.0 [14.02]	19.0 [0.75]	10.0 [0.39]	6.4 [0.25] 0.25" Lead
STP-LE17-2C06ADJ	152.4 [6.00]	39.3 [1.55]	203.6 [8.02]	19.0 [0.75]	10.0 [0.39]	6.5 [0.47] 3.0 mm Lead
STP-LE17-2C09ADJ	228.6 [9.00]	39.3 [1.55]	279.8 [11.02]	19.0 [0.75]	10.0 [0.39]	6.5 [0.47] 3.0 mm Lead
STP-LE17-2C12ADJ	304.8 [12.00]	39.3 [1.55]	356.0 [14.02]	19.0 [0.75]	10.0 [0.39]	6.5 [0.47] 3.0 mm Lead
STP-LE17-2D06ADJ	152.4 [6.00]	39.3 [1.55]	203.6 [8.02]	19.0 [0.75]	12.7 [0.50]	8.0 [0.31] 1.25 mm Lead
STP-LE17-2D09ADJ	228.6 [9.00]	39.3 [1.55]	279.8 [11.02]	19.0 [0.75]	12.7 [0.50]	8.0 [0.31] 1.25 mm Lead
STP-LE17-2D12ADJ	304.8 [12.00]	39.3 [1.55]	356.0 [14.02]	19.0 [0.75]	12.7 [0.50]	8.0 [0.31] 1.25 mm Lead
STP-LE17-3A06ADJ	152.4 [6.00]	47.8 [1.88]	212.1 [8.35]	19.0 [0.75]	10.0 [0.39]	6.4 [0.25] 0.25" Lead
STP-LE17-3A09ADJ	228.6 [9.00]	47.8 [1.88]	288.3 [11.35]	19.0 [0.75]	10.0 [0.39]	6.4 [0.25] 0.25" Lead
STP-LE17-3A12ADJ	304.8 [12.00]	47.8 [1.88]	364.5 [15.35]	19.0 [0.75]	10.0 [0.39]	6.4 [0.25] 0.25" Lead
STP-LE17-3B06ADJ	152.4 [6.00]	47.8 [1.88]	212.1 [8.35]	19.0 [0.75]	10.0 [0.39]	6.4 [0.25] 0.5" Lead
STP-LE17-3B09ADJ	228.6 [9.00]	47.8 [1.88]	288.3 [11.35]	19.0 [0.75]	10.0 [0.39]	6.4 [0.25] 0.5" Lead
STP-LE17-3B12ADJ	304.8 [12.00]	47.8 [1.88]	364.5 [15.35]	19.0 [0.75]	10.0 [0.39]	6.4 [0.25] 0.5" Lead
STP-LE17-3E06ADJ	152.4 [6.00]	47.8 [1.88]	212.1 [8.35]	19.0 [0.75]	12.7 [0.50]	8.0 [0.31] 8.0 mm Lead
STP-LE17-3E09ADJ	228.6 [9.00]	47.8 [1.88]	288.3 [11.35]	19.0 [0.75]	12.7 [0.50]	8.0 [0.31] 8.0 mm Lead
STP-LE17-3E12ADJ	304.8 [12.00]	47.8 [1.88]	364.5 [15.35]	19.0 [0.75]	12.7 [0.50]	8.0 [0.31] 8.0 mm Lead

STP-LE23-xxANN

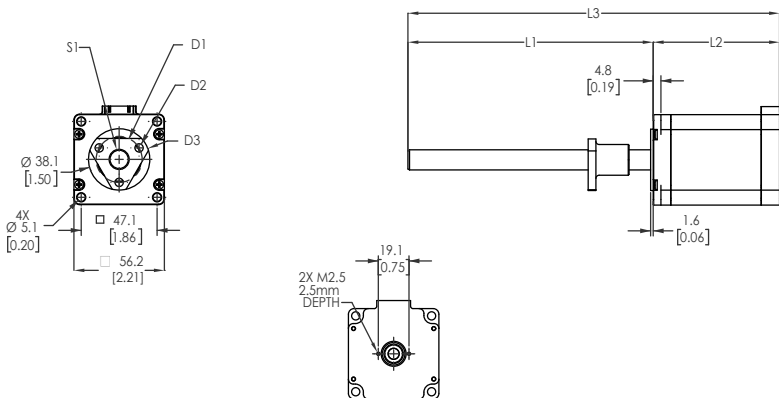

STP-LE23-xxANN Dimensions (mm [in])

Part #	L1	L2	L3	D1	D2	D3	S1
STP-LE23-1F06ANN	152.4 [6.00]	44.5 [1.75]	196.9 [7.75]	Ø22.2 [0.87] BC	3x Ø3.56 [0.14]	Ø29.5 [1.16]	10.0 [0.39] 10.5 mm Lead
STP-LE23-1F09ANN	228.6 [9.00]	44.5 [1.75]	273.1 [10.75]	Ø22.2 [0.87] BC	3x Ø3.56 [0.14]	Ø29.5 [1.16]	10.0 [0.39] 10.5 mm Lead
STP-LE23-1F12ANN	304.8 [12.00]	44.5 [1.75]	349.3 [13.75]	Ø22.2 [0.87] BC	3x Ø3.56 [0.14]	Ø29.5 [1.16]	10.0 [0.39] 10.5 mm Lead
STP-LE23-1G06ANN	152.4 [6.00]	44.5 [1.75]	196.9 [7.75]	Ø28.58 [1.13] BC	3x Ø5.2 [0.20]	Ø38.1 [1.50]	12.0 [0.47] 2.0 mm Lead
STP-LE23-1G09ANN	228.6 [9.00]	44.5 [1.75]	273.1 [10.75]	Ø28.58 [1.13] BC	3x Ø5.2 [0.20]	Ø38.1 [1.50]	12.0 [0.47] 2.0 mm Lead
STP-LE23-1G12ANN	304.8 [12.00]	44.5 [1.75]	349.3 [13.75]	Ø28.58 [1.13] BC	3x Ø5.2 [0.20]	Ø38.1 [1.50]	12.0 [0.47] 2.0 mm Lead
STP-LE23-1H06ANN	152.4 [6.00]	44.5 [1.75]	196.9 [7.75]	Ø28.58 [1.13] BC	3x Ø5.2 [0.20]	Ø38.1 [1.50]	12.0 [0.47] 6.0 mm Lead
STP-LE23-1H09ANN	228.6 [9.00]	44.5 [1.75]	273.1 [10.75]	Ø28.58 [1.13] BC	3x Ø5.2 [0.20]	Ø38.1 [1.50]	12.0 [0.47] 6.0 mm Lead
STP-LE23-1H12ANN	304.8 [12.00]	44.5 [1.75]	349.3 [13.75]	Ø28.58 [1.13] BC	3x Ø5.2 [0.20]	Ø38.1 [1.50]	12.0 [0.47] 6.0 mm Lead
STP-LE23-3H06ANN	152.4 [6.00]	78.5 [3.09]	230.9 [9.09]	Ø28.58 [1.13] BC	3x Ø5.2 [0.20]	Ø38.1 [1.50]	12.0 [0.47] 6.0 mm Lead
STP-LE23-3H09ANN	228.6 [9.00]	78.5 [3.09]	307.1 [12.09]	Ø28.58 [1.13] BC	3x Ø5.2 [0.20]	Ø38.1 [1.50]	12.0 [0.47] 6.0 mm Lead
STP-LE23-3H12ANN	304.8 [12.00]	78.5 [3.09]	383.3 [15.09]	Ø28.58 [1.13] BC	3x Ø5.2 [0.20]	Ø38.1 [1.50]	12.0 [0.47] 6.0 mm Lead
STP-LE23-3K06ANN	152.4 [6.00]	78.5 [3.09]	230.9 [9.09]	Ø28.58 [1.13] BC	3x Ø5.2 [0.20]	Ø38.1 [1.50]	12.5 [0.50] 1in Lead
STP-LE23-3K09ANN	228.6 [9.00]	78.5 [3.09]	307.1 [12.09]	Ø28.58 [1.13] BC	3x Ø5.2 [0.20]	Ø38.1 [1.50]	12.5 [0.50] 1in Lead
STP-LE23-3K12ANN	304.8 [12.00]	78.5 [3.09]	383.3 [15.09]	Ø28.58 [1.13] BC	3x Ø5.2 [0.20]	Ø38.1 [1.50]	12.5 [0.50] 1in Lead

STP-LE23-xxADJ

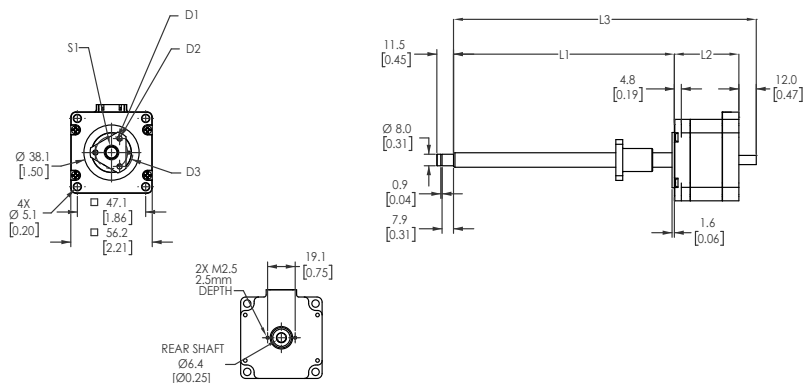

STP-LE23-xxADJ Dimensions (mm [in])

Part #	L1	L2	L3	D1	D2	D3	S1
STP-LE23-1F06ADJ	152.4 [6.00]	44.5 [1.75]	208.9 [8.22]	Ø22.2 [0.87] BC	3x Ø3.56 [0.14]	Ø29.5 [1.16]	10.0 [0.39] 10.5 mm Lead
STP-LE23-1F09ADJ	228.6 [9.00]	44.5 [1.75]	285.1 [11.22]	Ø22.2 [0.87] BC	3x Ø3.56 [0.14]	Ø29.5 [1.16]	10.0 [0.39] 10.5 mm Lead
STP-LE23-1F12ADJ	304.8 [12.00]	44.5 [1.75]	361.3 [14.22]	Ø22.2 [0.87] BC	3x Ø3.56 [0.14]	Ø29.5 [1.16]	10.0 [0.39] 10.5 mm Lead
STP-LE23-1G06ADJ	152.4 [6.00]	44.5 [1.75]	208.9 [8.22]	Ø28.58 [1.13] BC	3x Ø5.2 [0.20]	Ø38.1 [1.50]	12.0 [0.47] 2.0 mm Lead
STP-LE23-1G09ADJ	228.6 [9.00]	44.5 [1.75]	285.1 [11.22]	Ø28.58 [1.13] BC	3x Ø5.2 [0.20]	Ø38.1 [1.50]	12.0 [0.47] 2.0 mm Lead
STP-LE23-1G12ADJ	304.8 [12.00]	44.5 [1.75]	361.3 [14.22]	Ø28.58 [1.13] BC	3x Ø5.2 [0.20]	Ø38.1 [1.50]	12.0 [0.47] 2.0 mm Lead
STP-LE23-1H06ADJ	152.4 [6.00]	44.5 [1.75]	208.9 [8.22]	Ø28.58 [1.13] BC	3x Ø5.2 [0.20]	Ø38.1 [1.50]	12.0 [0.47] 6.0 mm Lead
STP-LE23-1H09ADJ	228.6 [9.00]	44.5 [1.75]	285.1 [11.22]	Ø28.58 [1.13] BC	3x Ø5.2 [0.20]	Ø38.1 [1.50]	12.0 [0.47] 6.0 mm Lead
STP-LE23-1H12ADJ	304.8 [12.00]	44.5 [1.75]	361.3 [14.22]	Ø28.58 [1.13] BC	3x Ø5.2 [0.20]	Ø38.1 [1.50]	12.0 [0.47] 6.0 mm Lead
STP-LE23-3H06ADJ	152.4 [6.00]	78.5 [3.09]	242.9 [9.06]	Ø28.58 [1.13] BC	3x Ø5.2 [0.20]	Ø38.1 [1.50]	12.0 [0.47] 6.0 mm Lead
STP-LE23-3H09ADJ	228.6 [9.00]	78.5 [3.09]	319.1 [12.56]	Ø28.58 [1.13] BC	3x Ø5.2 [0.20]	Ø38.1 [1.50]	12.0 [0.47] 6.0 mm Lead
STP-LE23-3H12ADJ	304.8 [12.00]	78.5 [3.09]	395.3 [15.56]	Ø28.58 [1.13] BC	3x Ø5.2 [0.20]	Ø38.1 [1.50]	12.0 [0.47] 6.0 mm Lead
STP-LE23-3K06ADJ	152.4 [6.00]	78.5 [3.09]	242.9 [9.06]	Ø28.58 [1.13] BC	3x Ø5.2 [0.20]	Ø38.1 [1.50]	12.5 [0.50] 1in Lead
STP-LE23-3K09ADJ	228.6 [9.00]	78.5 [3.09]	319.1 [12.56]	Ø28.58 [1.13] BC	3x Ø5.2 [0.20]	Ø38.1 [1.50]	12.5 [0.50] 1in Lead
STP-LE23-3K12ADJ	304.8 [12.00]	78.5 [3.09]	395.3 [15.56]	Ø28.58 [1.13] BC	3x Ø5.2 [0.20]	Ø38.1 [1.50]	12.5 [0.50] 1in Lead

Thrust vs. Speed Charts

The dashed horizontal lines indicate the maximum thrust allowed by the nut. Note that some motors and leads can result in thrust above the nut's limit. Ensure that the system does not apply too much force to the nut (example: limit the motor current, or monitor position feedback to determine a stall). Allow sufficient time to accelerate the load and size the step motor with a 100% thrust safety factor (i.e.: design the system using a maximum of 50% of the motor's thrust).

STP-LE17-2xxxx (Double-stack motors)

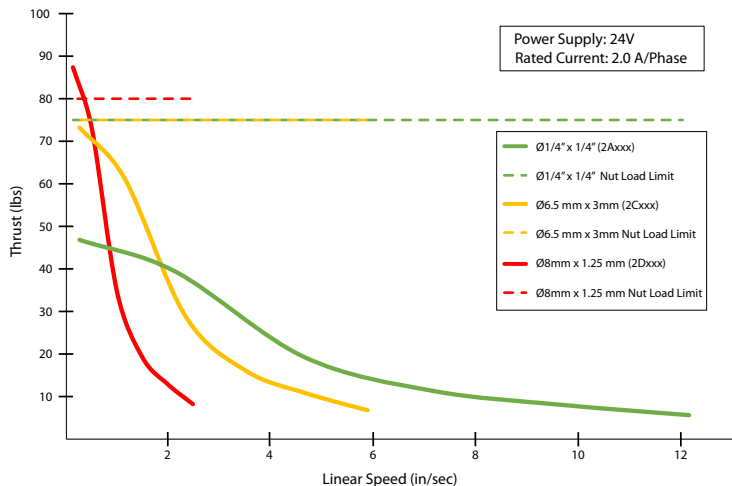

STP-LE17-3xxxx (Triple-stack motors)

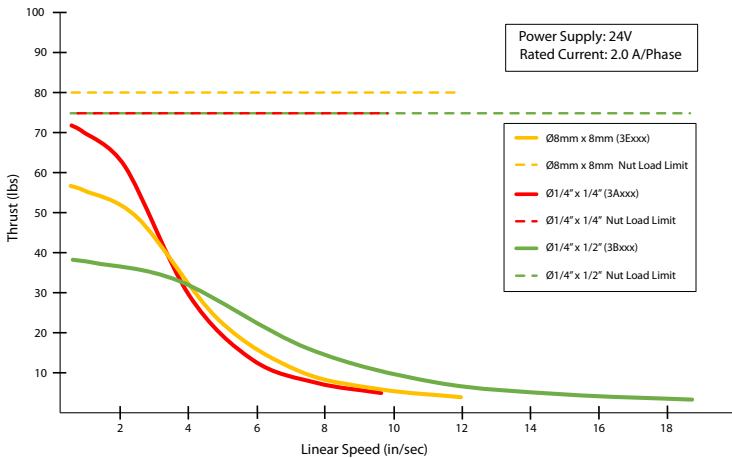

STP-LE23-1xxxx (Single-stack motors)

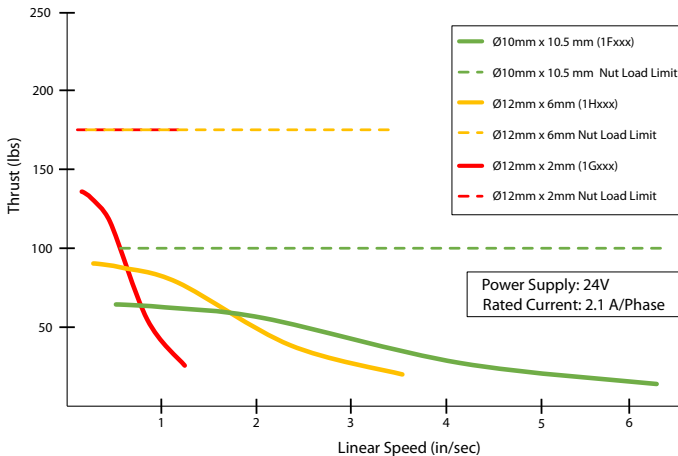

STP-LE23-3xxxx (Triple-stack motors)

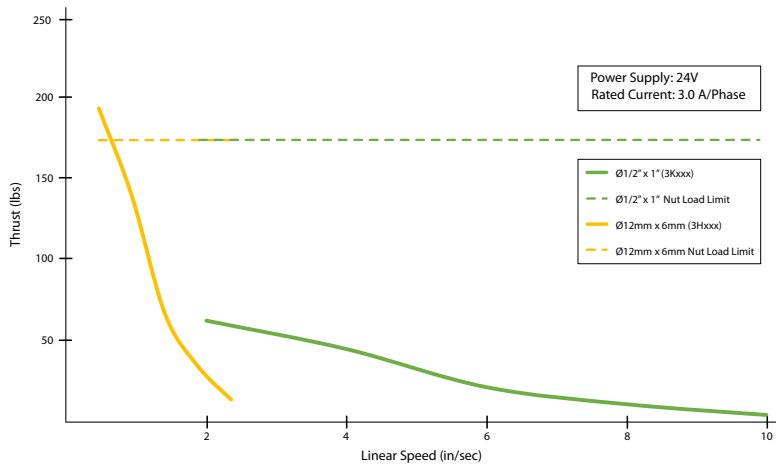

**SURESTEP™
SYSTEM POWER
SUPPLIES**



In This Chapter...

Features	9-2
Specifications	9-3
Drive Heating	9-4
Choosing a Power Supply	9-5
Power Supply Terminal & Component Layout	9-7
Mounting the Power Supply	9-8
Dimensions	9-9
Dimensions (continued)	9-10

Features

- Linear models available with 32V@4A, 48V@5A, 48V@10A, & 70V@5A DC unregulated step motor power
- 5VDC ±5% at 500 mA regulated logic power (electronic overload)
- Screw terminal AC input and DC output connectors
- 120 or 240 VAC, 50/60 Hz power input, switch selectable
- Power ON LEDs
- Integrated input and output fusing
- Matched to SureStep drives for maximum voltage
- Switching models also available. Series PSBxx-xxxS is recommended.



Linear Power Supplies



Switching Power Supplies



The stepping system power supplies can supply power for multiple SureStep STP-DRV-xxxx microstepping motor drives, depending on step motor size and application requirements. To select a power supply for multiple drives, use the following formula:

$$I(ps) \geq 0.66 \times (I_{motor1} + I_{motor2} + I_{motor3} + \dots)$$



Further information about braking accessories and regeneration clamping can be found in Appendix A and the STP-DRVA-RC-050 REGENERATION CLAMP datasheet.

Specifications

SureStep™ Linear Power Supply Specifications				
Part Number	STP-PWR-3204	STP-PWR-4805	STP-PWR-4810	STP-PWR-7005
Input Power (fuse protected)¹⁾	1-phase, 120/240 VAC, 50/60 Hz, 150 VA Fuse ¹⁾ : 3A	1-phase, 120/240 VAC, 50/60 Hz, 350 VA Fuse ¹⁾ : 5A	1-phase, 120/240 VAC, 50/60 Hz, 650 VA Fuse ¹⁾ : 8A	1-phase, 120/240 VAC, 50/60 Hz, 500 VA Fuse ¹⁾ : 7A
Input Voltage	120/240 VAC ±10% ⁽³⁾ (switch selectable; voltage range switch is set to 240 VAC from factory)			
Inrush Current	120 VAC < 12A 240 VAC < 14A	120 VAC < 20A 240 VAC < 24A	120 VAC < 40A 240 VAC < 50A	
Motor Supply Output (linear unregulated, fuse protected¹⁾, power on LED indicator)	32 VDC @ 4A (full load) 35 VDC @ 1A load 41 VDC @ no load Fuse ¹⁾ : 6A	46.5 VDC @ 5A (full load) 52 VDC @ 1A load 57.5 VDC @ no load Fuse ¹⁾ : 8A	46.5 VDC @ 10A (full load) 50 VDC @ 1A load 57.5 VDC @ no load Fuse ¹⁾ : 15A	70 VDC @ 5A (full load) 79 VDC @ 1A load 86.5 VDC @ no load ⁽³⁾ Fuse ¹⁾ : 8A
SureStep Drive Compatibility 2)	STP-DRV-4035 (STP-DRV-4850) (STP-DRV-80100)	STP-DRV-4850 (STP-DRV-80100)		STP-DRV-80100
Logic Supply Output	5VDC ±5% @ 500 mA (regulated, electronically overload protected, power on LED indicator)			
Watt Loss	13W	25W	51W	42W
Storage Temperature	-55 to 85 °C -67 to 185 °F			
Operating Temperature	0 to 50 °C (32 to 122 °F) full rated; 70 °C (158 °F) maximum Derate current 1.1% per degree above 50 °C			
Humidity	95% (non-condensing) relative humidity maximum			
Cooling Method	Natural convection (mount power supply to metal surface if possible)			
Dimensions (in [mm])	4.00 x 7.00 x 3.25 [101.6x177.8x8.26]	5.00 x 8.10 x 3.88 [127.0x205.7x98.6]	5.62 x 9.00 x 4.62 [142.7 x 228.6 x 117.3]	
Mounting	Use four (4) #10 screws to mount on either wide or narrow side.			
Weight (lb [kg])	6.5 [2.9]	11 [4.9]	18 [8.3]	16 [7.2]
Connections	Screw Terminals, tightening torque of 4.5 in·lbs			
Agency Approvals	UL (file # E181899), CSA, CE			

1) Fuses to be replaced by qualified service personnel only. Use (1-1/4 x 1/4 in) ceramic fast-acting fuses (Edison type ABC from AutomationDirect, or equivalent).

2) Caution: Do not use a power supply that exceeds the input voltage range of the drive. Using a lower voltage power supply with a higher voltage drive is acceptable, but will not provide full system performance.

3) An unloaded STP-PWR-7005 can float above the allowable input voltages of some drives if it is fed with a high AC input voltage (greater than 120VAC). Either ensure that the incoming AC supply is less than 120V, or supply a burden resistor to pull the unloaded linear DC voltage level down.

4) For switching power supply specifications, please refer to that part number's data sheet or manual.

Drive Heating

Note: The following information applies to STP-DRV-6575, STP-DRV-4850, and STP-DRV-80100 models only.

While STP drives efficiently transmit power between the power supply and motor, they do generate some heat in the process. This will cause the temperature of the drive to rise above the surrounding air temperature and may also require that the drive be mounted to a heat conducting metal surface.

For those who wish to calculate the power dissipation and temperature rise, the following information is provided:

1. Drive power dissipation P_d versus motor current and power supply voltage (see chart).
2. Drive thermal constant R_{Θ}

The final drive case temperature is given by:

$$T_c = T_a + R_{\Theta} * P_d$$

Where T_a is the ambient temperature of the surrounding air. The case of the drive should not be allowed to exceed 70°C or the life of the product could be reduced.

Drive Thermal Constant

- Narrow side of drive mounted on a 13.5" x 13.5" steel plate, 0.70" thick:

$$R_{\Theta} = 1.0^{\circ}\text{C/W}$$

- Narrow side of drive mounted on a non-heat conducting surface: $R_{\Theta} = 2.1^{\circ}\text{C/W}$

Drive Watt Loss

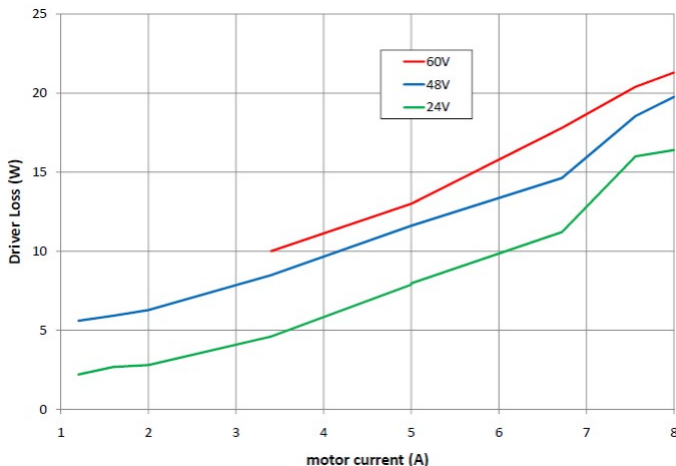

Choosing a Power Supply

Voltage

Chopper drives work by switching the voltage to the motor terminals on and off while monitoring current to achieve a precise level of phase current. Due to the inductances in the windings which rely on current to produce torque, the voltage should be much greater to allow fast changes in winding current (stepping). To do this efficiently and silently, you'll want to have a power supply with a voltage rating at least five times that of the motor. SureStep Drives are designed to work well with SureStep motors so choosing the proper voltage of the supply is made easy when using all AutomationDirect products. A compatibility chart for AutomationDirect power supplies and drives is located below.

SureStep™ Power Supply Compatibility				
Drive	Linear Power Supply			
	STP-PWR-3024	STP-PWR-4805	STP-PWR-4810	STP-PWR-7005*
STP-DRV-4035	✓	No	No	No
STP-DRV-4830	✓	✓	✓	No
STP-DRV-4845	✓	✓	✓	No
STP-DRV-4850	✓	✓	✓	No
STP-DRV-6575	✓	✓	✓	No
STP-DRV-80100	✓	✓	✓	✓
STP-MTRD-17	✓	✓	✓	No
STP-MTRD-23,-24	✓	✓	✓	✓
Drive	Switching Power Supply			
	PSB12-xxxS	PSB24-xxxS	PSB48-xxxS	
STP-DRV-4035	✓	✓	No	
STP-DRV-4830	✓	✓	✓	
STP-DRV-4845	✓	✓	✓	
STP-DRV-4850	No	✓	✓	
STP-DRV-6575	No	✓	✓	
STP-DRV-80100	No	✓	✓	
STP-MTRD-17	✓	✓	✓	
STP-MTRD-23,-24	✓	✓	✓	

*An unloaded STP-PWR-7005 can float above the allowable input voltages of some drives if it is fed with a high AC input voltage (greater than 120VAC). Either ensure that the incoming AC supply is less than 120V, or supply a burden resistor to pull the unloaded liner DC voltage level down.

Depending on how fast you want to run the motor, you may need even more voltage. Generally, more is better; the upper limit being the maximum voltage rating of the drive itself. With voltage, there is a trade-off between higher voltage and increased heating.

Voltage determines max speed. A higher voltage power supply equals higher top-end motor speed. But higher voltages also mean higher temperatures (drive and motor), so the lowest voltage that will satisfy your required speed should be used.

Linear (Unregulated) vs Switching (Regulated) Power Supplies

If you choose an unregulated power supply, do not allow the “no load” voltage to exceed the maximum voltage rating of the drive. Unregulated supplies are rated at full load current. At lesser loads, such as when the motor is not moving, the actual voltage can be up to 25% greater than the voltage listed on the power supply label. Some applications may have regeneration (the motor tries to decelerate a large load quickly and becomes a generator). The motor tries to dump the excess energy back into the drive (and supply). This can sometimes boost the DC voltage up higher than the regulated supply would normally output which can turn into an overvoltage situation, causing the power supply to shut down. Regeneration clamp STP-DRVA-RC-050 can help in these situations. It is installed between the power supply and drive, where it monitors incoming power supply voltage and the voltage on the drive side. If the drive side goes higher than the incoming (the motor is regenerating power), the clamp “dumps” energy out to its resistor. Linear supplies don’t care (they will just float higher), but regulated supplies might trip. STP-DRVA-BR-100 allows the regeneration clamp to “dump” even more energy from the system.

Current

The maximum supply current you will need is the sum of the two phase currents. However, you will generally need a lot less than that, depending on the motor type, voltage, speed and load conditions. That’s because the SureStep drives use switching amplifiers, converting a high voltage and low current into lower voltage and higher current. The more the power supply voltage exceeds the motor voltage, the less current you’ll need from the power supply.

We recommend the following selection procedure:

1. If you plan to use only a small number of drives, choose a power supply using the following formula:

$$I(ps) \geq 0.66 \times (I_{\text{motor1}} + I_{\text{motor2}} + I_{\text{motor3}} + \dots)$$

2. If you are designing for mass production and must minimize cost, get one power supply with more than twice the rated current of the motor. Install the motor in the application and monitor the current coming out of the power supply and into the drive at various motor loads. This test will tell you how much current you really need so you can design in a lower cost power supply.

If you plan to use a regulated or switching power supply, you may encounter a problem with current foldback. When you first power up your drive, the full current of both motor phases will be drawn for a few milliseconds while the stator field is being established. After that, the amplifiers start chopping and much less current is drawn from the power supply. If your power supply thinks this initial surge is a short circuit it may “foldback” to a lower voltage. With many foldback schemes the voltage returns to normal only after the first motor step and is fine thereafter. In that sense, unregulated power supplies are better.

Power Supply Terminal & Component Layout

STP-PWR-3204

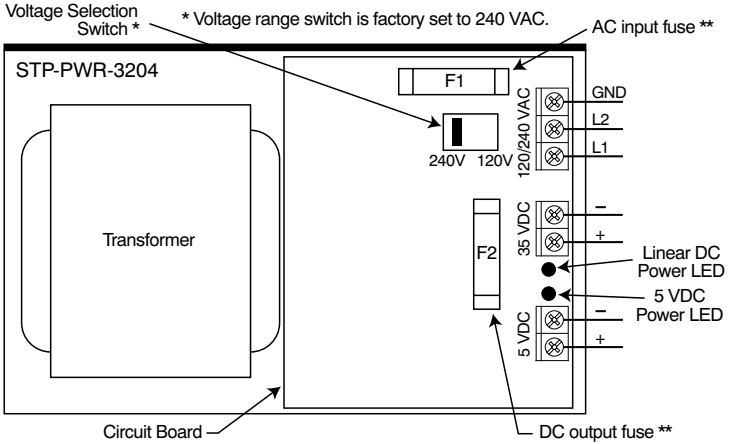

** Fuses are listed in power supply specifications table.
 ** Fuses to be replaced by qualified service personnel only.

STP-PWR-4805, STP-PWR-4810, STP-PWR-7005

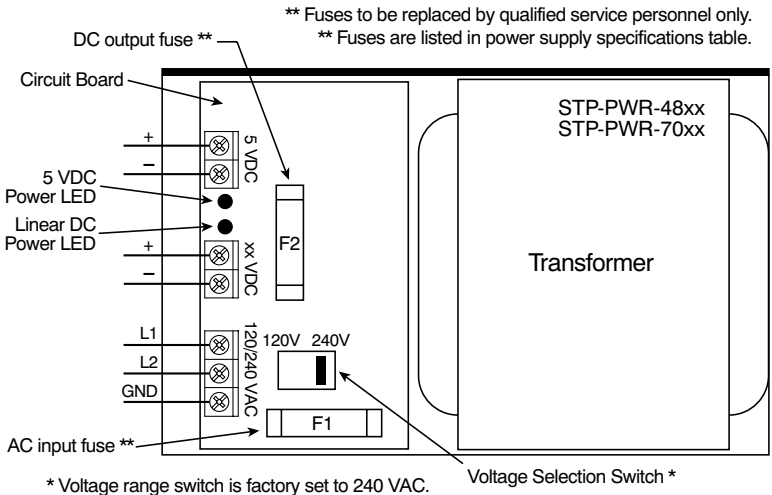

** Fuses to be replaced by qualified service personnel only.
 ** Fuses are listed in power supply specifications table.

Mounting the Power Supply

STP-PWR-xxxx power supplies can be mounted on either the bottom (wide) side, or the back (narrow) side of the chassis. Either orientation contains mounting holes for machine screws. Use #10 screws for STP-PWR-3204 and -4805, or 1/4" screws for STP-PWR-4810 and -7005.

Since power supplies generate heat, they should be mounted in a location that allows air flow. They also should be securely fastened to a smooth, flat metal surface that will dissipate heat.

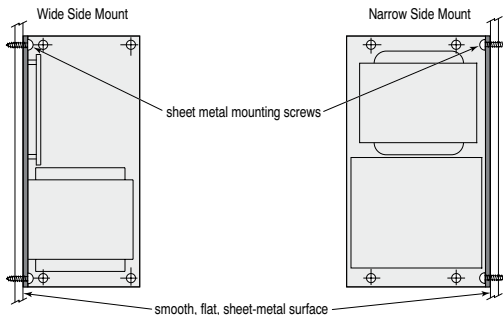

Warning: Never use the power supply in a space where there is no air flow, or where the surrounding air temperature is greater than 70 °C.

Dimensions

STP-PWR-3204

Dimensions = [in] mm

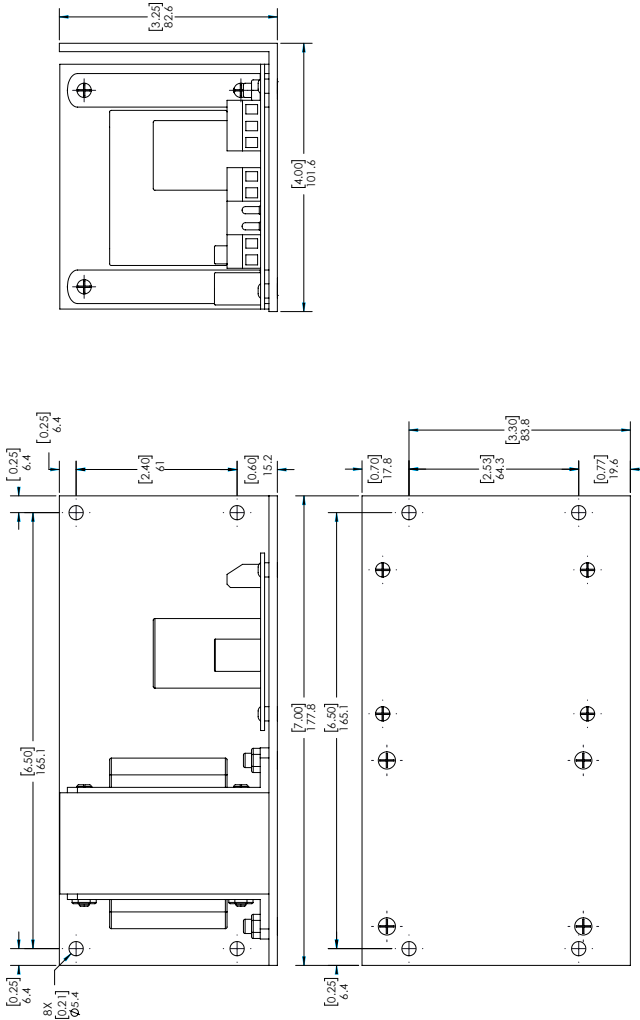

Dimensions (continued)

STP-PWR-4805, -4810, -7005

Dimensions = [in] mm

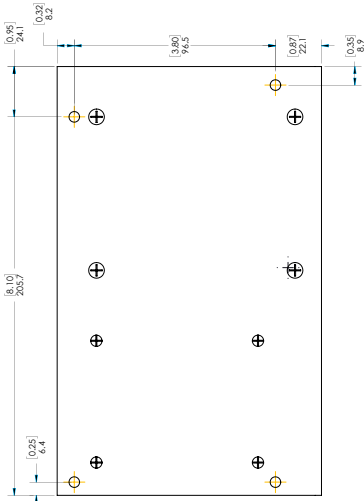
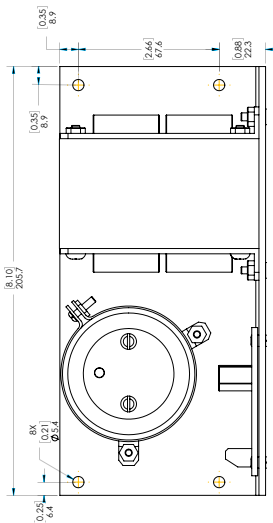
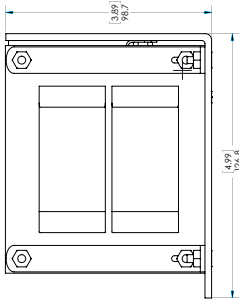

SureStep™ Series – 48V & 70V Power Supplies			
	STP-PWR-4805	STP-PWR-4810	STP-PWR-7005
Mtg Screw	#10		1/4

**SUREMOTION PRO
CONFIGURATION
SOFTWARE**



**CHAPTER
10**

In This Chapter...

SureMotion™ Pro Software	10-2
Communication	10-2
Motor Configuration	10-2
Motion and I/O	10-3
Drive Pull-down Menu.....	10-4

SureMotion™ Pro Software

The SureStep advanced drives STP-DRV-4850 & -80100 and advanced integrated motor/drives (STP-MTRD-17R, -23R, and -24R) are configured using SureMotion Pro™ configuration software, which is available for download from the Automationdirect.com website.



Note: SureMotion Pro is the successor to SureStep Pro. Anything that could be done with SureStep Pro can still be done with SureMotion Pro.

The software is divided into two major sections, “Motion and I/O” and “Motor” configuration. There are also communication settings, drive selection, and drive status features.

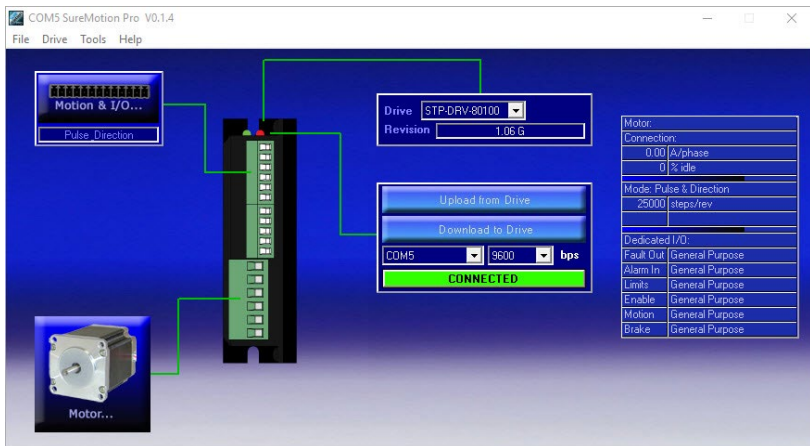

Complete software instructions are included in the “Help” files within the software.

Communication

Upload and Download from/to the drive. When you connect to a drive, the Motor, Motion Mode, and Dedicated I/O settings that are currently in the drive will appear on the right of the screen (as will the Drive and Revision at the top of the screen). “Upload from Drive” to get all the configuration settings from the drive or “Download to Drive” to apply all the settings on the PC to the drive.

Motor Configuration

Clicking on the “Motor..” icon will bring up the motor configuration screen. You can choose a motor from the pull-down menu or enter a custom motor (you will need to enter that motor’s specific information). If you know the inertia mismatch of the load, you should enter it. If the inertia mismatch is unknown, this entry can be left at 1. The idle current is default at 50%. Idle current should be used unless the application

will require a constant high holding torque

Motor

Standard motor STPMTR17040 Cancel OK

Custom motor Define Custom Motor... Help Wiring

Running Current: amps

Idle Current: % (0.85 A)

Idle Current Delay: secs

Motor Specs:

Connection: 4 leads

Holding Torque: 0.4 N m

Rated Current: 1.7 A

Rotor Inertia: 50.0 g cm²

Smoothing Gain: 0

Phase: 0

Max Lead Angle: 90 deg

Speed: 20 rev/sec

Load Inertia: g cm²

1.0 X rotor inertia

Define Custom Motor

Name:

Rated Current: amps

Holding Torque: oz in

Rotor Inertia: g cm²

Max Lead Angle (required for stall prevention): degrees, at rev/sec

Waveform Smoothing: Gain Phase Wizard...

Maximum Voltage: %

Help Cancel OK

Motion and I/O

Selecting this tab will allow you to set the drive's mode of operation.

Motion Control Mode

Pulse Input Mode

Velocity (Oscillator) Mode

SCL
Serial Command Language (SCL)

Cancel

- **Pulse and Direction:**
Used with high-speed pulse inputs (CW/CCW, Pulse/Direction, Quadrature) generated from a PLC, encoder, etc.
- **Velocity (Oscillator):**
Allows the drive to be speed controlled by an analog signal. The input is 0 - 5V and can be scaled to the desired maximum speed. Bidirectional motion can be attained by changing the Offset (under "Advanced Analog Settings") to a non-zero value. EX: Setting this value to 2500mV will command the drive to be at zero speed when 2.5V are present.
- **Serial Command Language (SCL):**
Causes the drive to respond to serial commands. A PLC or PC can issue a variety of commands to enable simple motion, gearing/following, turn on the output, wait for an input, etc. See the "SCL Manual" under the SureMotion Pro Help menu. Serial commands can be tested by selecting the "Drive" pull-down menu from the menu bar, and then selecting "SCL Terminal".

Drive Pull-down Menu

This software menu gives you several features to monitor and test the drive.

- Self-Test – Rotates the motor clockwise and counterclockwise.
(Tests motor and cabling)
- Status Monitor – Shows the current Drive and I/O status.
- SCL Terminal – Allows SCL commands to be tested by typing them in.
(HyperTerminal is NOT a good tool for serial commands, because the drive will “time-out” if you use HyperTerminal to enter strings. SCL Terminal will send the entire string at once.)
- Alarm History – Will read back the most recent drive faults
- Clear Alarm – Will clear the current drive fault.
- Restore Factory Defaults – resets the drive to “out of the box” status.
- Set Quick Decel Rate – Used when the drive encounters faults or overtravel limits.



If using SCL mode, and if testing is done with SCL terminal, make sure to disconnect software and turn power off to the drive for at least 10 seconds to clear the drive's communication buffer.



SCL terminal can be used to test SCL strings before programming your PLC. However, PLC communications will fail after using SCL Terminal unless the drive is powered down for at least 10 seconds before attempting PLC-to-drive communication.

SURESTEP™
COMMUNICATIONS



CHAPTER
11

In This Chapter...

Connecting to a Host Using RS-485	11-2
Four-Wire Configuration	11-2
Two-Wire Configuration	11-3
Assigning RS-485 Addresses	11-3
Connecting to an STP-MTRD-xxxxR using the STP-USB485-4W Adapter	11-4
Connecting to a drive using RJ12	11-5

Connecting to a Host Using RS-485

The Advanced integrated motor/drives (STP-MTRD-xxxxxR) support RS-485 ASCII/SCL serial communication. RS-485 communication allows connection of more than one drive to a single host PC, PLC, HMI or other computer. It also allows the communication cable to be long (more than 300 meters or 1000 feet).

For electrically noisy environments we recommend twisted pair cable with an overall shield and drain wire. Connect the drain wire at one end of the cable to earth ground.

RS-485 can be used with either four-wire or two-wire configurations. Both types of configurations can be used for point-to-point (i.e. one drive and one host) or multi-drop networks (one host and up to 32 drives).

GND (circuit ground)

TX-

TX+

RX-

RX+

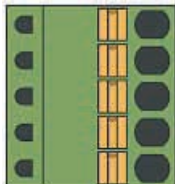

RS-485 Connector Diagram



To use the STP-MTRD-xxxxxR RS-485 with SureMotion Pro, the STP-MTRD-xxxxxR must be connected to the PC in the four-wire "point-to-point" configuration and configured one axis at a time. The DA command is useful in setting up multiple drives.

Four-Wire Configuration

Four-wire systems utilize separate transmit and receive wires. One pair of wires must connect the host's transmit signals to each drive's RX+ and RX- terminals. The other pair connects the drive's TX+ and TX- terminals to the host's receive signals. A logic ground terminal is provided on each drive and can be used to keep all drives at the same ground potential. This terminal connects internally to the DC power supply return (V-), so if all the drives on the RS-485 network are powered from the same supply it is not necessary to connect the logic grounds. One drive's GND terminal should still be connected to the host computer ground.

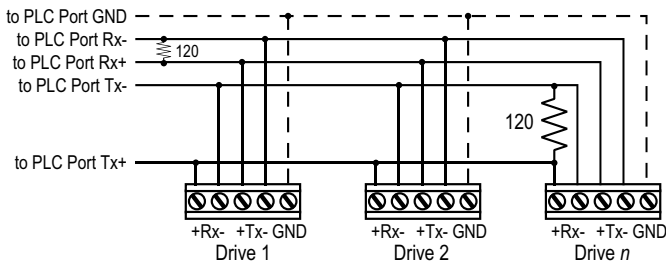

A 120 ohm terminating resistor is required at the end of a four-wire network.



If the PC does not have an RS-485 serial port, a converter will be required. ADC part number STP-USB485-4W is recommended.

Two-Wire Configuration

Two-wire systems use the same pair of wires to transmit and receive. This can lead to trouble as the host must not only disable its transmitter before it can receive data, it must do so quickly before a drive begins to answer a query. The STP-MTRD-xxxxR includes a “transmit delay” parameter that can be adjusted to compensate for a host that is slow to disable its transmitter. This adjustment can be made over the network using the TD command, or it can be set using the SureMotion Pro software. It is not necessary to set the transmit delay in a four-wire system.



2-wire communication is not recommended for STP-MTRD-xxxxR systems when connected to SureMotion Pro configuration software. Some SureMotion Pro features (firmware upgrade, etc.) may not work correctly. Use a 4-wire configuration for best results.

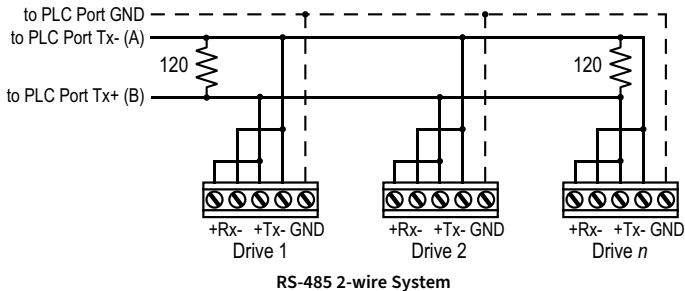

RS-485 2-wire System



A 120 ohm terminating resistor is required at both ends of a 2-wire network.

Assigning RS-485 Addresses

Before wiring the entire system, you'll need to connect each drive individually to the host computer so that a unique address can be assigned to each drive using SureMotion Pro if you want to assign addresses to the drives. This is required if you plan to talk to multiple drives that are on the same network. See the “DA” SCL command. Use the programming cable and the SureMotion Pro software that came with your drive for this purpose.

Connect the drive to your PC and then launch the SureMotion Pro software. Select the com port that is connected to the drive. Finally, apply power to your drive. If you have already configured your drive, then you should click the Upload button so that the SureMotion Pro settings match those of your drive. Click on the Motion & I/O button, then select the “SCL” operating mode. The RS-485 Address panel should appear. If you would like to assign the drive a unique address, just click on the address character of your choice. You can use the numerals 0-9, or any of the following special

characters: ! " # \$ % & ' () * + , - . / : ; < = > ? @. Just make sure that each drive on your network has a unique address. If you are using a 2-wire network, you may need to set the Transmit Delay too. 10 milliseconds works on most adapters. Once you've made your configuration choices, click Download to save the settings to your drive.

If a drive is assigned an address (1) then it will respond to commands prefixed by that address (for example: 1FL2000) but it will also respond to the same command without the address (for example: FL2000). Commands without an address are known as global commands. The only difference is that the drive will not send an acknowledgement back to the host when given a global command. If you have four addressed drives on a network and you send FL2000, then all drives will respond to the command but none will send an acknowledgement.

Connecting to an STP-MTRD-xxxxR using the STP-USB485-4W Adapter

The STP-USB485-4W is an excellent choice for USB to serial conversion. It can be used for all RS-232 and RS-485 applications.

For RS-485 two-wire systems, set the switches and make the connections to the STP-MTRD-xxxxR according to the diagrams below:



Note: 2-wire is used by some AutomationDirect PLCs.

RS-485 Two-wire Settings	
STP-USB485-4W 6-pin screw terminal connector	STP-MTRD-xxxxR 5-pin connector
1	RX-, TX-
2	RX+, TX+
6	GND

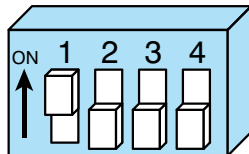

RS-485 2-wire Switch Settings

For RS-485 four-wire systems, set the switches and make the connections to the STP-MTRD-xxxxR according to the diagrams below:

RS-485 Four-wire Settings	
STP-USB485-4W 6-pin screw terminal connector	STP-MTRD-xxxxR 5-pin connector
1	RX-
2	RX+
3	TX+
4	TX-
6	GND

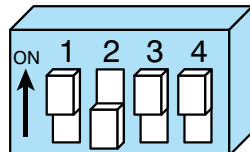

RS-485 4-wire Switch Settings



Note: 4-wire is needed for communications to SureMotion Pro.

Connecting to a drive using RJ12

Multiple drives can easily be configured by connecting them using the ZL-CDM-RJ12X4 or ZL-CDM-RJ12X10 RJ12 feedthrough modules. Use SureMotion Pro to assign unique addresses to each drive, then use the feedthrough module to network them together. The diagram on the next page shows a very convenient way to configure (PC) and control (PLC) multiple RS-485 integrated stepper motor/drives. This diagram uses a 2-wire RS-485 connection (CLICK and several other AutomationDirect PLCs only support 2-wire RS-485).

Drive configuration using SureMotion Pro:

The drives must be configured one at a time using SureMotion Pro (they all have the same network address out-of-the-box). Disconnect all but one drive from the ZL-CDM-RJ12X4 or ZL-CDM-RJ12X10 breakout board. That drive can now be configured by the PC. Plug the cable with the DB9 connector into the USB/RS-485 converter (the “Configure” option in the diagram on the next page). Configure each drive (connect only one at a time to the network) with SureMotion Pro. Remember that the PLC cannot be connected to the network while the PC is configuring drives, as there can only be one master on the network at a time.

Controlling the network of drives from a PLC using SCL commands:

Once all the drives are uniquely addressed, plug all the RJ12 cables back into the ZL-CDM-RJ12X4 or ZL-CDM-RJ12X10 feedthrough module. Unplug the USB/RS-485 converter from the RS-485 network and plug the DB9 connector into the ZL-RTB-DB09 feedthrough module (the “Control” option in the diagram). Pins 1 & 4 need to be tied together and pins 2 and 3 need to be tied together for 2-wire RS-485 communications (Most AutomationDirect PLCs only support 2-wire RS-485. Only the 06 and 260 CPU support 4-wire RS-485). See “Two-Wire Configuration” on page 9-3 for an example diagram.

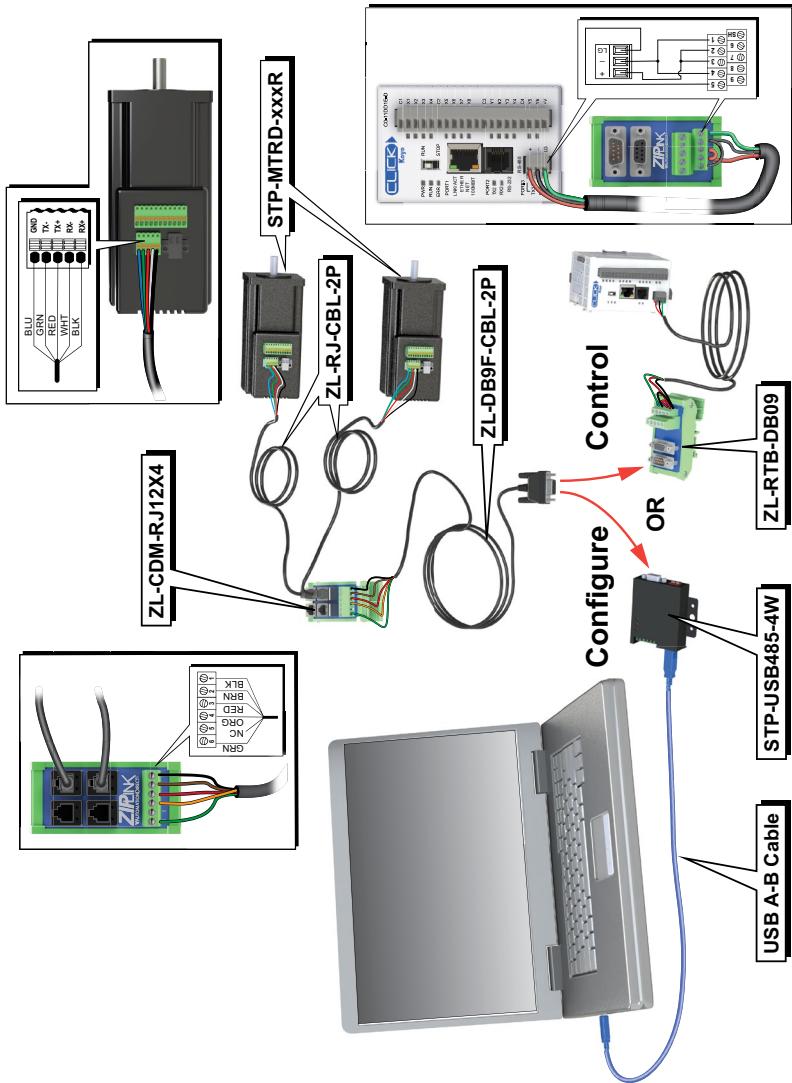

RJ12 Connection Methods with Integrated Motor/Drives

SureStep™ ACCESSORIES



APPENDIX A

In This Appendix...

Braking Accessories	A-2
Regeneration Clamp Features	A-2
Cables and Accessories	A-5
Encoder Options	A-8
Encoder Specifications	A-13
Differential Electrical Specifications	A-15
Wiring Examples	A-16
Line Filters	A-21

Braking Accessories

If you plan to use a regulated or switching power supply, you might encounter problems from power regeneration. As a load rapidly decelerates from a high speed, much of the kinetic energy of that load is transferred back to the motor. This energy is then pushed back to the drive and power supply, resulting in increased system voltage. The larger the motor the more common this becomes. If there is enough overhauling load on the motor, the DC voltage will go above the drive and/or power supply limits.

This can trip the overvoltage protection of a switching power supply or a drive, and cause it to shut down.

To solve this problem, AutomationDirect offers a regeneration clamp STP-DRVA-RC-050A. The regeneration clamp has a built-in 50W braking resistor. The STP-DRVA-RC-050A does not have an external resistor.

STP-DRVA-RC-050 and the optional 100W braking resistor are no longer available, but are included here for reference purposes.

You can test whether regen is needed by installing a single unit in the first installation. If the regen LED (red) never flashes, then you may not need the clamp.

Further information about braking accessories and regeneration clamping can be found in the REGENERATION CLAMP datasheet.

Regeneration Clamp Features

- Built-in 50W power resistor
- Mounted on a heat sink
- Voltage range: 24–80 VDC; no user adjustments required
- Power: 50W continuous; 800W peak
- Indicators (LED):
Green = power supply voltage is present
Red = clamp is operating (usually when stepper is decelerating)
- Protection: The external power supply is internally connected to an “Input Diode” in the regen clamp that protects the power supply from high regeneration voltages. This diode protects the system from connecting the power supply in reverse. If the clamp circuit fails, the diode will continue to protect the power supply from over-voltage.

STP-DRVA-RC-050 Features:

- External 100W resistor available
- Multiple drives in parallel up to 20A total output current
- Non-removable terminal blocks
- Uses 12-18 AWG wire for connections

STP-DRVA-RC-050A Features:

- Three drive connections, 7A max per channel, 15A total output current
- Removable terminal blocks (replacement kit STP-CON-4)
- Uses 18-20 AWG wire for connections

SureStep™ Stepping Systems – Braking Accessories

Part Number	Description
STP-DRVA-RC-050*	Regeneration Clamp: use with DC-powered stepper & servo drives; 50W, 24–80 VDC
STP-DRVA-RC050A*	Regeneration Clamp: 50W, for DC input stepper and servo drives
STP-DRVA-BR-100	Braking Resistor: use with STP-DRVA-RC-050 regen clamp; 100W, 10 ohms

* Do not use the regeneration clamp in an atmosphere containing corrosive gases.

Block Diagram – STP-DRV-xxxx STP-DRVA-RC-050 & STP-DRVA-BR-100

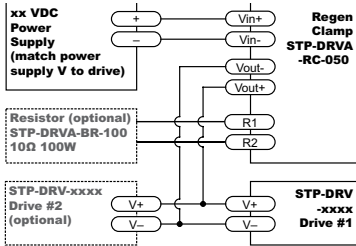

Dimensions – STP-DRVA-RC-050

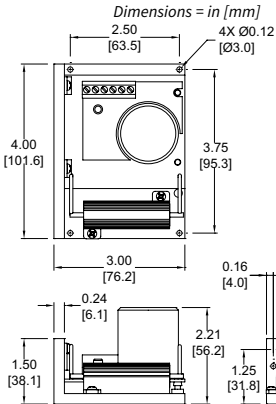

Dimensions – STP-DRVA-BR-100

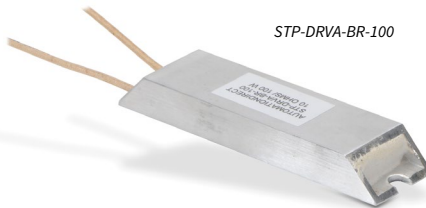
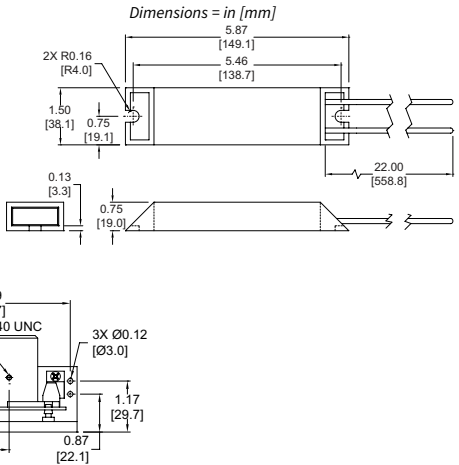



STP-DRVA-RC-050A

Dimensions - STP-DRVA-RC-050A

Dimensions = in [mm]

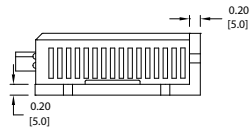
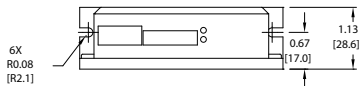
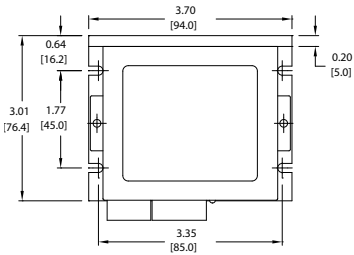

Cables and Accessories

Replacement cables and connector kits are available for use with SureStep motors, drives, and integrated motors/drives. See the table below for available accessories and the parts they are compatible with. Encoder cables are located in the Encoder Options section.

SureStep Cables & Accessories		
Part Number	Description	Use With
STP-CON-1	SureStep replacement connector kit.	STP-DRV-4845 & -6575
STP-CON-2	SureStep replacement connector kit.	STP-DRV-4850 STP-DRV-80100
STP-CON-3	SureStep replacement connector kit.	All STP-MTRD except STP-MTRD-17038 and 17048E
STP-CON-4	SureStep replacement connector kit.	STP-DRVA-RC-050A
STP-CON-5	SureStep replacement connector kit.	STP-DRV-4830
STP-CON-6	SureStep replacement connector kit.	STP-DRVAC-24025
STP-485DB9-CBL-2	Integrated motor/drive programming cable	STP-MTRD-xxxxR(E)
STP-USB485-4W	USB to RS-485 adapter, 4-wire	STP-MTRD-xxxxR(E)
STP-EXT-0xx	Motor to drive extension cable, xx = length in feet	STP-MTR-xxxx(x)
STP-EXTL-0xx	Motor to drive extension cable, xx = length in feet	STP-MTRL-xxxx(x)
STP-EXTH-0xx	Motor to drive extension cable, xx = length in feet	STP-MTRH-xxxx(x)
STP-EXTW-0xx	IP65 rated motor to drive extension cable, xx = length in feet	STP-MTR-xxxxW
STP-EXTHW-0xx	IP65 rated motor to drive extension cable, xx = length in feet	STP-MTRH-xxxxW
STP-LA-EXT17-0xx	SureStep extension cable, 6-pin connector to pigtail (4 wires used), 6, 10, or 20ft cable length.	STP-LE17-xxxxxx
STP-LA-EXT23-0xx	SureStep extension cable, 6-pin connector to pigtail (4 wires used), 6, 10, or 20ft cable length.	STP-LE23-xxxxxx
STP-CBL-CAxx	Control cable for 17038 series integrated motor/drives, xx = length in feet	STP-MTRD-17038/17038E
STP-MTRA-17DMP	Metal body SureStep damper. For use with NEMA 17 stepper motors with 5mm shafts.	STP-MTR-17xxx(x)
STP-MTRA-23DMP	Metal body SureStep damper. For use with NEMA 23 stepper motors with 1/4 in. shafts.	STP-MTR-23xxx(x) STP-MTRAC-23xxxD
STP-MTRA-SCRWKT-1	SureStep encoder mounting screw kit.	All stepper encoders ¹
STP-MTRA-42ENC	NEMA 42 Encoder adapter plate for Same Sky AMT31/AMT33 encoders	STP-MTRAC(H)-42xxxD
CUI-KIT-1	Same Sky encoder accessory kit, replacement. Includes (1) AMT102 base, (1) AMT102 wide base, and (1) AMT10 sleeve kit (9 sleeves sized 2-8mm).	Same Sky AMT102 encoders
CUI-KIT-2	Same Sky encoder accessory kit, replacement. Includes (1) AMT standard base, (1) AMT standard wide base, and (1) AMT10 sleeve kit (9 sleeves sized 2-8mm).	Same Sky AMT103 encoders
<i>1 - For NEMA42 motors, screws are not included in this kit. Screws are included with the STP-MTRA-42ENC adapter plate.</i>		
<i>Continued on next page</i>		

SureStep Cables & Accessories (continued)		
Part Number	Description	Use With
CUI-KIT-3	Same Sky encoder accessory kit, replacement. Includes (1) AMT standard base, (1) AMT standard wide base, and (1) AMT standard sleeve kit (9 sleeves sized from 2-8mm).	Same Sky AMT11 and AMT31 encoders
CUI-KIT-4	Same Sky encoder sleeve kit, replacement. Includes (8) sleeves sized from 9-14mm.	Same Sky AMT13 and AMT33 encoders
STP-LA-NTFA	SureStep lead screw flange nut, replacement, triangular, 0.25in/rev, 0.25in lead screw diameter.	SureStep STP-LE series screw code A
STP-LA-NTFB	SureStep lead screw flange nut, replacement, triangular, 0.5in/rev, 0.25in lead screw diameter.	SureStep STP-LE series screw code B
STP-LA-NTFC	SureStep lead screw flange nut, replacement, triangular, 3mm/rev, 6.5mm lead screw diameter.	SureStep STP-LE series screw code C
STP-LA-NTFD	SureStep lead screw flange nut, replacement, triangular, 1.25mm/rev, 8mm lead screw diameter.	SureStep STP-LE series screw code D
STP-LA-NTFE	SureStep lead screw flange nut, replacement, triangular, 8mm/rev, 8mm lead screw diameter.	SureStep STP-LE series screw code E
STP-LA-NTFF	SureStep lead screw flange nut, replacement, triangular, 10.5mm/rev, 10mm lead screw diameter.	SureStep STP-LE series screw code F
STP-LA-NTFG	SureStep lead screw flange nut, replacement, triangular, 2mm/rev, 12mm lead screw diameter.	SureStep STP-LE series screw code G
STP-LA-NTFH	SureStep lead screw flange nut, replacement, triangular, 6mm/rev, 12mm lead screw diameter.	SureStep STP-LE series screw code H
STP-LA-NTFK	SureStep lead screw flange nut, replacement, triangular, 1in/rev, 0.5in lead screw diameter.	SureStep STP-LE series screw code K
STP-LA-NRFA	SureStep lead screw flange nut, round, 0.25in/rev, 0.25in lead screw diameter.	SureStep STP-LE series screw code A
STP-LA-NRFB	SureStep lead screw flange nut, round, 0.5in/rev, 0.25in lead screw diameter.	SureStep STP-LE series screw code B
STP-LA-NRFC	SureStep lead screw flange nut, round, 3mm/rev, 6.5mm lead screw diameter.	SureStep STP-LE series screw code C
STP-LA-NRFD	SureStep lead screw flange nut, round, 1.25mm/rev, 8mm lead screw diameter.	SureStep STP-LE series screw code D
STP-LA-NRFE	SureStep lead screw flange nut, round, 8mm/rev, 8mm lead screw diameter.	SureStep STP-LE series screw code E
STP-LA-NRFF	SureStep lead screw flange nut, round, 10.5mm/rev, 10mm lead screw diameter.	SureStep STP-LE series screw code F
STP-LA-NRFG	SureStep lead screw flange nut, round, 2mm/rev, 12mm lead screw diameter.	SureStep STP-LE series screw code G
STP-LA-NRFH	SureStep lead screw flange nut, round, 6mm/rev, 12mm lead screw diameter.	SureStep STP-LE series screw code H
STP-LA-NRFK	SureStep lead screw flange nut, round, 1in/rev, 0.5in lead screw diameter.	SureStep STP-LE series screw code K

STP-EXTx-0xx Extension Cable Wiring Diagram

EXT & EXTH CABLES

PIN#	COLOR
1	RED
2	WHITE
3	GREEN
4	BLACK

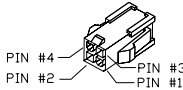

EXTL CABLES

PIN#	COLOR
1	RED
2	WHITE
3	GREEN
4	BLACK



CONNECTORS:

EXT: Molex #43020-0401
 EXTH: Molex #39-01-2041
 EXTL: TE #103653-3

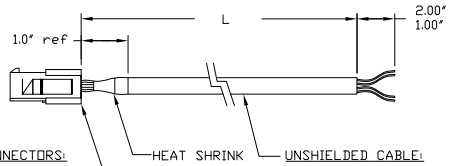

UNSHIELDED CABLE:

(4) 20 AWG cond
 (4) 18 AWG cond
 (4) 24 AWG cond

STP-EXTW-0xx and STP-EXTHW-0xx Extension Cable Wiring Diagram

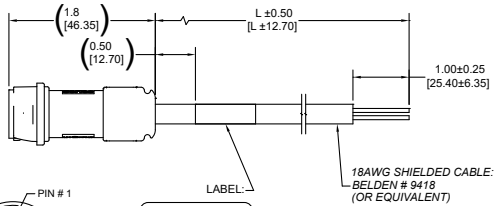
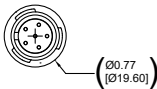

PIN OUT CONNECTION		
PIN #	COLOR	PHASE
1	RED	A+
2	WHITE	A-
3	GREEN	B+
4	BLACK	B-
5	GROUND	GROUND
6	N/A	N/A

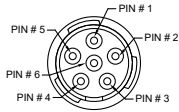

Connector: Bulgin # PXP4011/06P/6065

STP-485DB9-CBL-2 Wiring Diagram

CONNECTION CHART			
DB-9 CONN PIN	DB9 SIGNAL	WIRE COLOR	PHOENIX PIN / PHOENIX SIGNAL
2	TX+	RED	5 / RX+
1	TX-	ORANGE	4 / RX-
3	RX+	BLACK	3 / TX+
4	RX-	BROWN	2 / TX-
5	GND	YELLOW	1 / GND
METAL HOUSING	SHIELD	SHIELD	N/C / N/C

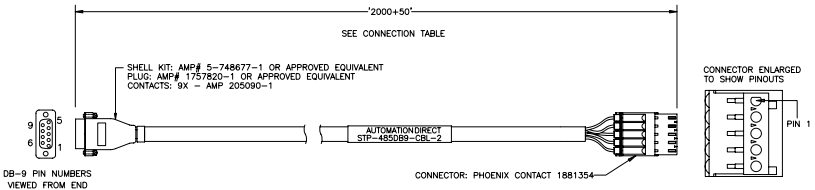

DB9-9 PIN NUMBERS VIEWED FROM END

STP-CBL-CAXx Control Cable Wiring Diagram

C1		
PIN NO.	SIGNAL	WIRE COLOR
1	STEP+	ORANGE
2	STEP-	BROWN
3	DIR+	YELLOW
4	DIR-	GREEN
5	EN+	BLUE
6	EN-	TAN
7	OUT+	GRAY
8	OUT-	WHITE
9	N.C.	PINK
10	V-	BLACK
11	V+	RED
12	N/C	PURPLE - CLIT

Note: For Rev A of this cable, STEP+ is Grey/
Pink and EN- is Red/Blue

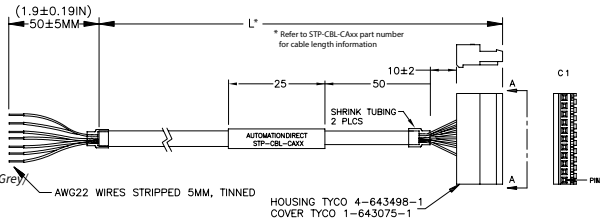

STP-LE17-xxxxxx Cable Wiring Diagram

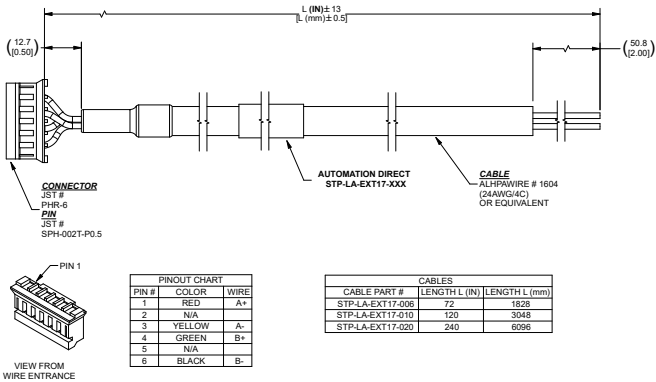

STP-LE23-xxxxxx Cable Wiring Diagram

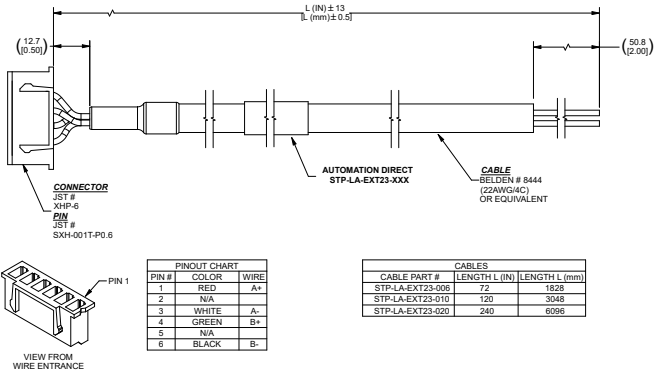

STP-EXT42(H)-xxx Cable Wiring Diagram

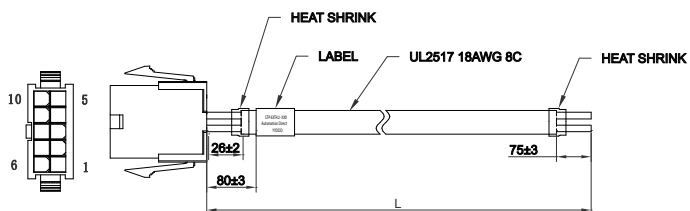

Pin	Wire Description
1	A - White
2	Ā - Orange
3	C - Green
4	C̄ - Brown
5	B - Red
6	B̄ - Yellow
7	D - Black
8	D̄ - Blue
9	GND - Drain wire

Encoder Options

The standard integrated motors and dual-shaft stepper motors have options for mounting an external encoder. The NEMA 14, 17, 23/24, and 34 dual-shaft motors come with pre-tapped holes on the rear end cap for mounting the STP-MTRA-ENCx encoders. The NEMA 42 dual-shaft motors require an STP-MTRA-42ENC adapter plate for encoder mounting. All high bus voltage dual-shaft motors also come with pre-tapped holes. The “E” stepper motors and integrated models come with an encoder installed. This encoder can be replaced with other options. All STP-MTRA-ENCx encoders are incremental A/B quadrature type. Please see the compatibility table below. For these encoders, the hardware in STP-MTRA-SCRWKT-1 is used to attach the encoder to the compatible motor.



NOTE: Using the CLICK or BRX PLC requires the use of an FC-ISO-C signal conditioner.

SureStep Brand Encoder Compatibility						
Encoder Part Number	PPR	Bore Diameter	Output Type	PLC Compatibility	Motor Compatibility	Matching Cable
STP-MTRA-ENC1	1000	5mm	Line Driver	P2-HSI, P3-HSI, BRX ² , CLICK C0-1xDxE-D ²	STP-MTRx-14xxxD STP-MTRx-14xxxE STP-MTRx-17xxxD STP-MTRx-17xxxE Standard STP-MTRD-xxxxE	STP-CBL-EAxx
STP-MTRA-ENC3	400					
STP-MTRA-ENC2	1000		Push-pull (totem)			
STP-MTRA-ENC4	400					STP-CBL-EDxx
STP-MTRA-ENC5	1000	0.25 inch	Line Driver	P2-HSI, P3-HSI, BRX ² , CLICK C0-1xDxE-D ²	STP-MTRx-23xxxD STP-MTRx-23xxxE STP-MTRAC-23xxxD	STP-CBL-EAxx
STP-MTRA-ENC7	400					
STP-MTRA-ENC6	1000		Push-pull (totem)			
STP-MTRA-ENC8	400					STP-CBL-EDxx
STP-MTRA-ENC9 (AMT-112Q-V)	48 to 4096 ¹	2mm - 8mm	Line Driver	P2-HSI, P3-HSI, BRX ² , CLICK C0-1xDxE-D ²	STP-MTRx-14xxxD STP-MTRx-14xxxE STP-MTRx-17xxxD STP-MTRx-17xxxE STP-MTRx-23xxxD STP-MTRx-23xxxE STP-MTRAC-23xxxD Std STP-MTRD-xxxxE STP-LE17-xxxADJ STP-LE23-xxxADJ	STP-CBL-EBxx AMT-PGRM-17C
STP-MTRA-ENC10 (AMT-112S-V)			Push-pull (totem)			
STP-MTRA-ENC11	1000	0.375 inch	Line Driver	P2-HSI, P3-HSI, BRX ² , CLICK C0-1xDxE-D	STP-MTRAC-34xxxD	STP-CBL-EAxx
STP-MTRA-ENC13	400					
STP-MTRA-ENC12	1000		Push-pull (totem)			
STP-MTRA-ENC14	400					STP-CBL-EDxx

1 - Configurable (default=400). Requires configuration cable AMT-PGRM-17C.
2 - Requires FC-ISO-C (see wiring diagrams below for DIP switch settings).

For all encoders listed below, please use the hardware contained in STP-MTRA-SCRWKT-1 to attach the encoder to the compatible motor.

Same Sky Brand Encoder Compatibility						
Encoder Part Number	PPR	Bore Diameter	Output Type	PLC Compatibility	Motor Compatibility	Matching Cable
AMT102-V	48 to 2048 ¹	2mm - 8mm	push-pull (totem)	BRX ² , CLICK C0-1xDxE-D ²	STP-MTRx-14xxxD STP-MTRx-14xxxE STP-MTRx-17xxxD STP-MTRx-17xxxE STP-MTRx-23xxxD ³ STP-MTRx-23xxxE STP-MTRAC-23xxxD Standard STP-MTRD- xxxxxE STP-LE17-xxxADJ STP-LE23-xxxADJ	CUI-313x-xxx
AMT103-V ³						CUI-435-xxx or CUI-3934-6FT
AMT112S-V	48 to 4096 ¹		line driver (differential)	P2-HSI, P3-HSI, BRX ² , CLICK C0-1xDxE-D ²		AMT-17C-1-xxx
AMT112Q-V			line driver (differential)	P2-HSI, P3-HSI, BRX ² , CLICK C0-1xDxE-D ²		AMT-17C-1-xxx
AMT312D-V	48 to 4096 ¹	9mm - 5/8"	push-pull (totem)	BRX ² , CLICK C0-1xDxE-D ²	STP-MTRx-34xxxD STP-MTRAC(H)- 42xxxD ⁴ (Does not fit STP- MTRAC-34 motors)	AMT-18C-3-xx
AMT312S-V			line driver (differential)	P2-HSI, P3-HSI, BRX ² , CLICK C0-1xDxE-D ²		
AMT132S-V		push-pull (totem)	BRX ² , CLICK C0-1xDxE-D ²			
AMT132Q-V		line driver (differential)	P2-HSI, P3-HSI, BRX ² , CLICK C0-1xDxE-D ²			
AMT332S-V		push-pull (totem)	BRX ² , CLICK C0-1xDxE-D ²			
AMT332D-V		line driver (differential)	P2-HSI, P3-HSI, BRX ² , CLICK C0-1xDxE-D ²			

1 - Configurable (default=400). AMT103-V is dip switch configurable. All others require configuration cable, see below.
 2 - Requires FC-ISO-C (see wiring diagrams below for DIP switch settings).
 3 - For AMT103-V to maintain NEMA23 compatibility, CUI-KIT-2 must be purchased to use the standard wide base for mounting.
 4 - STP-MTRA-42ENC adapter plate required for STP-MTRAC(H)-42xxxD compatibility.

AMT102 and AMT103 encoders can be configured with on-board DIP switches.

All other Same Sky encoders come preset at 400ppr as factory default. For other resolutions, a USB configuration cable is required (separate from the signal cables above).

- AMT11 and AMT31 encoders are configured with AMT-PGRM-17C.
- AMT13 and AMT33 encoders are configured with AMT-PGRM-18C.

STP-USBENC-CBL-1 Wiring Diagram

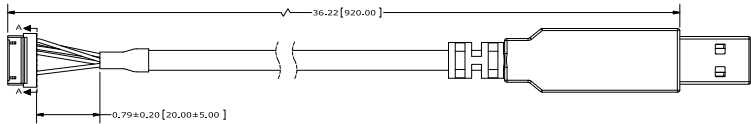

1715131192531



(Back of Connector Housing)

Connector Pinout		
#Function	Color	Pin
TX_ENCL	Yellow	1
RX_ENCL	Orange	2
GND	Black	4
+5V	Red	6
MCLR	Green	14

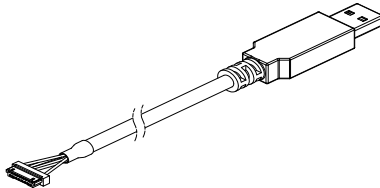

STP-CBL-EAxx Encoder Cable Wiring Diagram

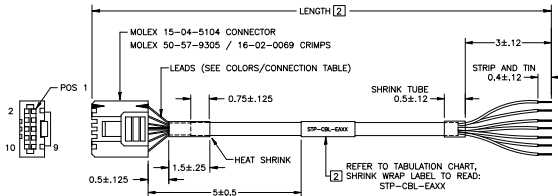

CONNECTION TABLE			
CONN	LEAD COLOR	SIGNAL	
2	GREEN/WHITE	GROUND	TWISTED PAIR
7	GREEN	POWER+	
3	ORANGE/WHITE	Z-	TWISTED PAIR
4	ORANGE	Z+	
5	BLUE/WHITE	A-	TWISTED PAIR
6	BLUE	A+	
9	BROWN/WHITE	B-	TWISTED PAIR
10	BROWN	B+	
1	N/C	N/A	NO CONNECTION
8	N/C	N/A	

WIRE: 24AWG, CABLE: UL2464.

STP-CBL-EBxx Encoder Cable Wiring Diagram

NOTE:

- Case_GND is connected internally to GND (BLACK/RED)
- Ground connected internally to cable shielding-customer ref. only
- Tolerance ± 0.2" (5) unless otherwise specified
- All materials must be RoHS compliant

TABLE INFORMATION	
CABLE NUMBER	CABLE LENGTH L
STP-CBL-EB3	3 Feet
STP-CBL-EB6	6 Feet
STP-CBL-EB10	10 Feet
STP-CBL-EB20	20 Feet

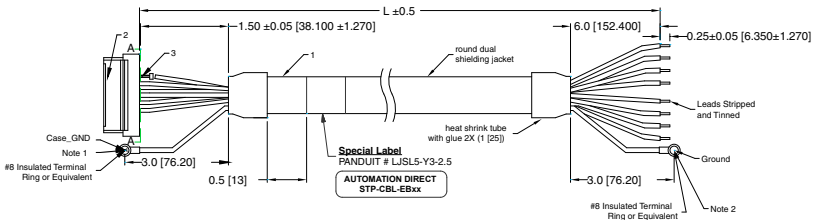

Connector Pinout			
#	Function	Primary Color	Stripe Color
4	GND	Black	Red
6	+5V	Red	Black
8	B+	Green	Black
9	B-	Black	Green
10	A+	Black	Black
11	A-	Black	White
12	Z+	Blue	Black
13	Z-	Black	Blue

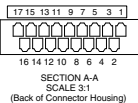

STP-CBL-EDxx Encoder Cable Wiring Diagram

STP-EDxx CABLES

PIN#	Function	Color
1	Ground	Black
2	Index	Green
3	A Channel	White
4	+5VDC Power	Red
5	B Channel	Brown

TABLE INFORMATION	
CABLE NUMBER	CABLE LENGTH L
STP-CBL-ED6	6 Feet
STP-CBL-ED10	10 Feet
STP-CBL-ED20	20 Feet

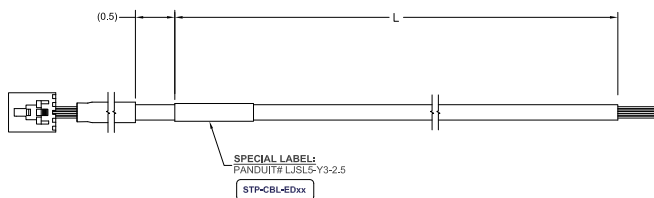

Connector part number:

- US Digital Part Number: CON-FC5
- Molex Part Number: 14600052



NOTE: Stepper motors can vibrate and resonate more than most motors. If this is an issue for your application use thread locking adhesive on the mounting screws.

Required Encoder Mounting Screws ^{1 2}				
Step Motor	Qty	Screw Description	Part Number	Image
STP-LE17-xxxADJ	2	M2.5 X 0.45 mm thread, 4mm long SS Slotted Screws, Narrow Cheese Head	McMaster Carr PN#: 91613A060	
STP-MTRL-14xxxD or E STP-MTR-17040D or E STP-MTR-17048D or E STP-LE23-xxxADJ	2	M2.5 X 0.45 mm, 5mm long, 8-18 SS Button Head Hex Drive Screw	McMaster Carr PN#: 92095A457	
STP-MTR-17060D or E	3	M2 X 0.4 mm, 5mm long 18-8 SS Pan Head Phillips Screws	McMaster Carr PN#: 92000A012	
STP-MTR-23xxxD or E STP-MTRH-23xxxD or E STP-MTRAC-34xxxD	2	4-40, 0.25 in long, 18-8 SS Pan Head Phillips Screw with captive washer	Olander.com PN#: 4C25PPIS	
STP-MTR-34xxxD STP-MTRH-34xxxD	2	M3 X 0.5 mm, 15mm long 18-8 SS Button Head Hex Drive Screws	McMaster Carr PN#: 992095A119	
STP-MTRAC-23xxxD	2	2-56, 0.25 in long, Zinc plated Steel Pan Head Phillips Screw with captive washer	McMaster Carr PN#: 90403A079	
STP-MTRD-xxxxxE	2	M3 X 0.5 mm, 8mm long 18-8 SS Pan Head Phillips Screws	McMaster Carr PN#: 94102A103	

1 - STP-MTRA-SCRWKT-1 contains all these screws.

2 - Encoder mounting screws for STP-MTRAC(H)-42xxxD motors are included in STP-MTRA-42ENC, not STP-MTRA-SCRWKT-1.

Encoder Mounting Accessories

STP-MTRA-42ENC

The STP-MTRA-42ENC mounting kit is required to mount an AMT13 or AMT33 encoder on the STP-MTRAC(H)-42xxxD series step motors.

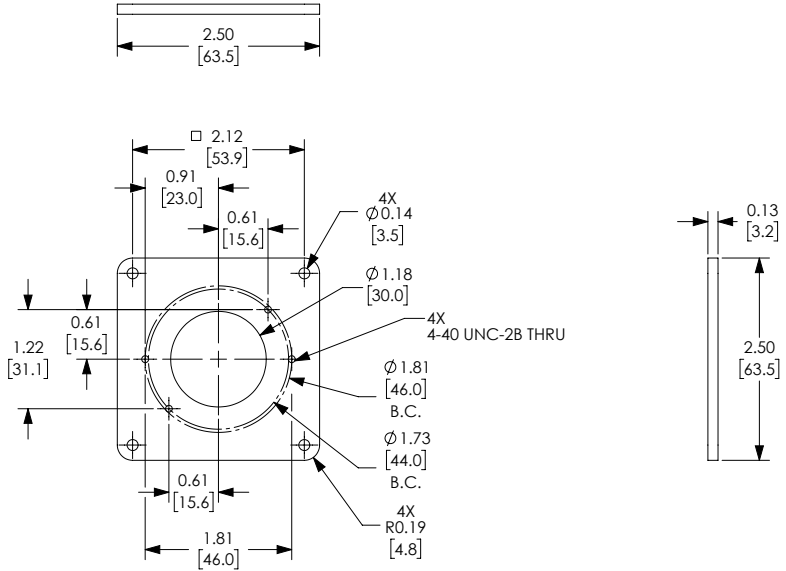

Encoder Specifications

Encoder General Specifications				
Encoder	STP-MTRA-ENC1, 3, 5, 7, 11, 13	STP-MTRA-ENC2, 4, 6, 8, 12, 14	STP-MTRA- ENC9	STP-MTRA- ENC10
Operating Temperature, CPR < 2000	-40 to 100°C (-40 to 212°F)		See AMT112Q-V datasheet	See AMT112S-V datasheet
Operating Temperature, CPR ≥ 2000	-25 to 100°C (-13 to 212°F)			
Vibration	20G (5Hz to 20kHz)			
Electrostatic Discharge	±2kV	±4kV		
Max. Shaft Axial Play	±0.010 inches [0.254 mm]			
Max Shaft Eccentricity plus Radial Play	0.004 inches			
Max Acceleration	250000 rad/sec ²			
Typical Product Weight	0.91 oz. [25.8 g]	0.82 oz [23.2 g]		
Hub Set Screw	#4-48			
Hex Wrench Size	0.050 inches			
Phase Relationship	A leads B for clockwise shaft rotation, and B leads A for counterclockwise rotation as viewed from the cover side of the encoder.			

For Same Sky encoder specifications, please refer to the specific datasheet found on the encoder Item Page on www.automationdirect.com.

SureStep Brand Bolt Circle Mounting Specifications (mm [inches])			
Bolt Hole Circle	Two Holes	Three Holes	Four Holes
Encoder			
STP-MTRA-ENC1	19.05 [0.75]	20.9 [0.823]	-
STP-MTRA-ENC3			
STP-MTRA-ENC2			
STP-MTRA-ENC4			
STP-MTRA-ENC5			
STP-MTRA-ENC7			
STP-MTRA-ENC6			
STP-MTRA-ENC8			
STP-MTRA-ENC9 (AMT-112Q-V)	16 [0.63] 19.05 [0.75]	20.9 [0.823] 21.55 [0.85] 22 [0.87]	25.4 [1])
STP-MTRA-ENC10 (AMT-112S-V)	32.44 [1.28] 46.02 [1.81]		
STP-MTRA-ENC11	19.05 [0.75] 46.02 [1.812]	20.9 [0.823]	-
STP-MTRA-ENC13			
STP-MTRA-ENC12			
STP-MTRA-ENC14			

Same Sky Brand Bolt Circle Mounting Specifications (mm [inches])			
Encoder \ Bolt Hole Circle	Two Holes	Three Holes	Four Holes
AMT102-V	16.00 [0.630] 19.05 [0.750] 32.430 [1.277] 46.025 [1.812]	22.00 [0.866]	25.40 [1.000]
AMT103-V		22.00 [0.866]	
AMT112S-V			
AMT112Q-V			
AMT312D-V			
AMT312S-V	43.84 [1.726]	-	-
AMT132S-V			
AMT132Q-V			
AMT332S-V			
AMT332D-V			

Differential Electrical Specifications

The following specifications apply over the entire operating temperature range. Typical values are specified at $V_{CC} = 5.0VDC$ and $25^{\circ}C$.

Encoder Electrical Specifications					
Encoder		STP-MTRA-ENC1, 3, 5, 7, 11, 13	STP-MTRA-ENC2, 4, 6, 8, 12, 14	STP-MTRA-ENC9	STP-MTRA-ENC10
Supply Voltage (V)	Min.	4.5		See AMT112Q-V datasheet	See AMT112S-V datasheet
	Typical	5			
	Max	5.5			
Supply Current (mA) ¹	Typical	29 (CPR < 500) 56 (CPR ≥ 500)	27 (CPR < 500) 54 (CPR ≥ 500)		
	Max	36 (CPR < 500) 65 (CPR ≥ 500)	33 (CPR < 500) 62 (CPR ≥ 500)		
Low-level Output ² (V)	Typical	0.2	n/a		
	Max	0.4	0.5		
High-level Output ³ (V)	Min	2.4	2.0		
	Typical	3.4	n/a		
Rise/Fall Time (nS)		15	110/100		
<p><i>1: No load</i></p> <p><i>2: IOL (Amps at Output Low) = 20mA max. (for all -ENC1 through -ENC14, except -ENC9 and 10)</i></p> <p><i>3: IOH (Amps at Output High) = 20mA max. (for all -ENC1 through -ENC14, except -ENC9 and 10)</i></p>					

Wiring Examples

Please see the pages below for wiring examples:

For STP-MTRA-ENC1, -ENC3, -ENC5, -ENC7, -ENC11, -ENC13

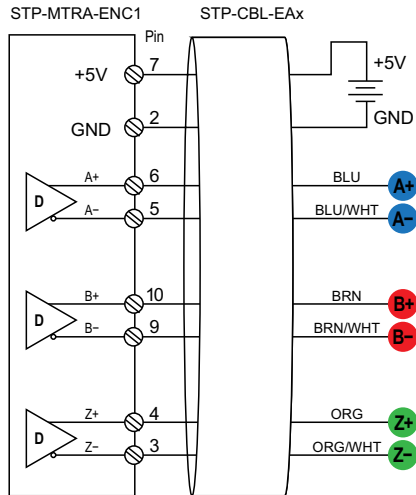

Optical Encoder Line Driver Wiring Diagram

For STP-MTRA-ENC2, -ENC4, -ENC6, -ENC8, -ENC12, -ENC14

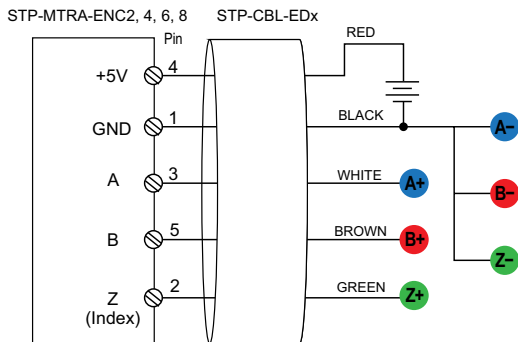

Optical Encoder Single Ended (Push-pull/Totem) Wiring Diagram

For STP-MTRA-ENC9 and Same Sky Encoders

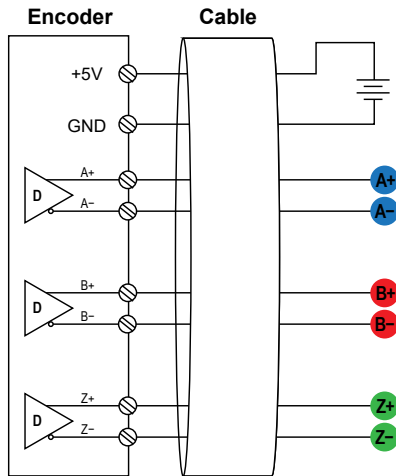

Configurable Encoder Line Driver Wiring Diagram

Line Driver Encoder Wiring Colors				
Encoder	AMT112Q-V AMT312D-V STP-MTRA-ENC9		AMT132Q-V AMT332D-V	
	Pin #	STP-CBL-EBx AMT-17C-1-xxx Wire Color	Pin #	AMT-18C-3-xxx Wire Color
+5V	6	RED/BLK	6	RED/GRN
GND	4	BLK/RED	4	GRN/RED
A+	10	WHT/BLK	8	BRN/WHT
A-	11	BLK/WHT	9	WHT/BRN
B+	8	GRN/BLK	10	GRN/WHT
B-	9	BLK/GRN	11	WHT/GRN
Z+	12	BLU/BLK	12	BLU/WHT
Z-	13	BLK/BLU	13	WHT/BLU

For STP-MTRA-ENC10 and Same Sky Encoders

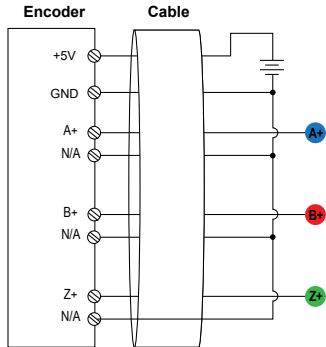

Configurable Encoder Single Ended (Push-pull/Totem) Wiring Diagram

Single Ended (Push-pull/Totem) Encoder Wiring Colors										
Encoder	AMT112S-V AMT132S-V STP-MTRA-ENC10		AMT132S-V AMT332S-V		AMT102-V			AMT103-V		
Pin Function	Pin #	STP-CBL-EBx AMT-17C-1-xxx Wire Color	Pin #	AMT-18C-3-xxx Wire Color	Pin #	CUI-3131-xxx Wire Color	CUI-3132-1FT Wire Color	Pin #	CUI-435-xxx Wire Color	CUI-3934-6FT Wire Color
+5V	6	RED/BLK	6	RED/GRN	5V	RED	ORG	5V	ORG	RED
GND	4	BLK/RED	4	GRN/RED	G	BLACK	BRN	G	BRN	BLACK
A+	10	WHT/BLK	8	BRN/WHT	A	WHT	BLU	A	BLU	WHT
N/A	11	BLK/WHT	9	WHT/BRN	-	-	-	-	-	-
B+	8	GRN/BLK	10	GRN/WHT	B	BRN	YEL	B	YEL	BRN
N/A	9	BLK/GRN	11	WHT/GRN	-	-	-	-	-	-
Z+	12	BLU/BLK	12	BLU/WHT	X	GRN	PUR	X	PUR	GRN
N/A	13	BLK/BLU	13	WHT/BLU	-	-	-	-	-	-

Single Ended (Push-pull/Totem) Commutation Wiring Colors					
Encoder	AMT312S-V			AMT332S-V	
Pin Function	Pin #	AMT-17C-1-xxx Wire Color	Pin #	AMT-18C-3-xxx Wire Color	
+5V	6	RED/BLK	6	RED/GRN	
GND	4	BLK/RED	4	GRN/RED	
U+	3	BRN/BLK	3	BRN/RED	
W+	5	ORG/BLK	5	ORG/RED	
V+	7	RED/WHT	7	BLU/RED	

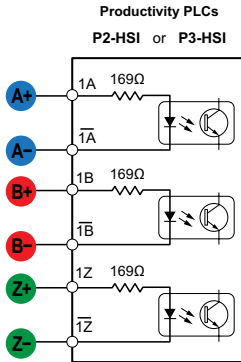

Productivity PLC Wiring Diagram

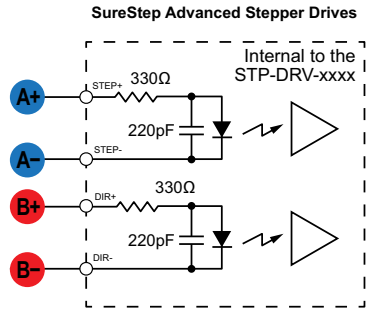

SureStep Advanced Stepper Drive Wiring Diagram

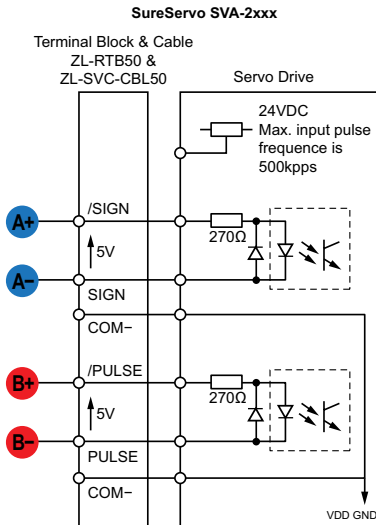

SureServo Wiring Diagram

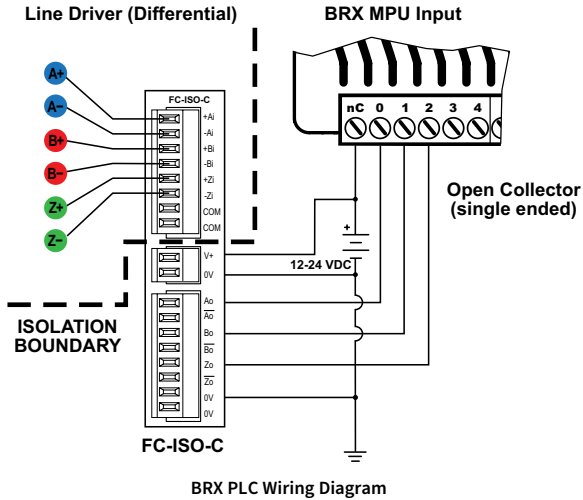

CLICK High Speed Inputs

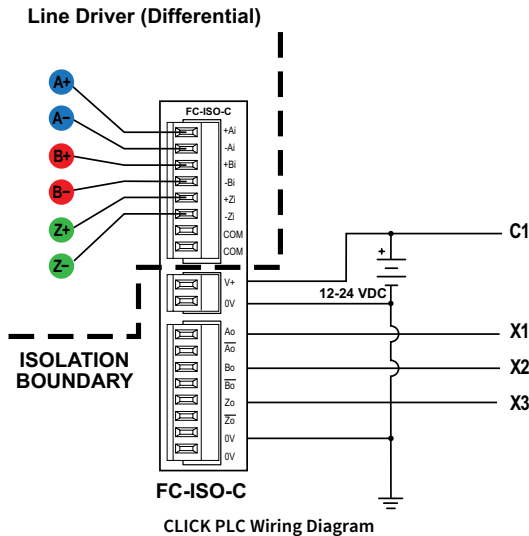

Line Filters

Line Filters	
Drive	Line Filter
STP-DRV-4035	RES10F06
STP-DRV-4830	RES10F03
STP-DRV-4845	RES10F06
STP-DRV-6575	RES10F10
STP-DRV-4850	RES10F06
STP-DRV-80100	RES10F10
STP-MTRD-17x	RES10F03
STP-MTRD-23x	RES10F06
STP-MTRD-24x	RES10F06
STP-DRVAC-24025	RES10F03

USING SureStep™ WITH AUTOMATIONDIRECT PLCs

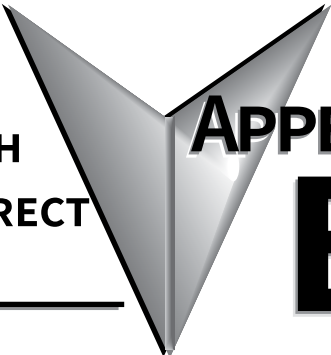

APPENDIX B

In This Appendix...

Compatible AutomationDirect PLCs and Modules	B-2
Typical Connections to a Productivity PLC.....	B-6
Typical Connections to a DL05 PLC	B-7
Typical Connections to an H0-CTRIO	B-8
Typical Connections – Multiple Drives/Motors	B-9
Typical <i>Direct</i> LOGIC PLC RS-232 Serial Connections to an Advanced SureStep Drive.....	B-10
Typical CLICK, P-Series, & BRX PLC RS-232 Serial Connections to an Advanced SureStep Drive.....	B-11
Typical RS-485 Connections to Integrated Motor/Drives	B-12

Compatible AutomationDirect PLCs and Modules

The following tables show which high-speed pulse-output PLCs and modules can be used with the SureStep Microstepping Motor Drives.

<i>Productivity PLCs/Modules for Use with SureStep Drives</i>	
Productivity Series High Speed Counter I/O Modules	
P3-HSO	Productivity3000 high-speed pulse output module, 1MHz maximum switching frequency, 2-channel, 4 general purpose output points, 5-24 VDC, sinking/sourcing, 6 general purpose input points, external 24 VDC required.
P2-HSO	Productivity2000 high-speed pulse output module, 1MHz maximum switching frequency, 2-channel, 4 general purpose output points, 5-24 VDC, sinking/sourcing, 6 general purpose input points, external 24 VDC required.

<i>BRX Series PLCs/Modules for Use with SureStep Drives</i>	
BRX Series High Speed Counter I/O Modules	
BX-DM1-10ED1-D	BRX Do-more PLC, 12-24 VDC required, serial port, microSD card slot, Discrete Input: 6-point, AC/DC, Discrete Output: 4-point, sinking.
BX-DM1-10ED2-D	BRX Do-more PLC, 12-24 VDC required, serial port, microSD card slot, Discrete Input: 6-point, AC/DC, Discrete Output: 4-point, sourcing.
BX-DM1E-10ED13-D	BRX Do-more PLC, 12-24 VDC required, Ethernet and serial ports, microSD card slot, Discrete Input: 6-point, AC/DC, Analog Input: 1-channel, current/voltage, Discrete Output: 4-point, sinking, Analog Output: 1-channel, current/voltage.
BX-DM1E-10ED23-D	BRX Do-more PLC, 12-24 VDC required, Ethernet and serial ports, microSD card slot, Discrete Input: 6-point, AC/DC, Analog Input: 1-channel, current/voltage, Discrete Output: 4-point, sourcing, Analog Output: 1-channel, current/voltage.
BX-DM1-18ED2-D	BRX Do-more PLC, 12-24 VDC required, serial port, microSD card slot, Discrete Input: 10-point, AC/DC, Discrete Output: 8-point, sourcing.
BX-DM1-18ED1-D	BRX Do-more PLC, 12-24 VDC required, serial port, microSD card slot, Discrete Input: 10-point, AC/DC, Discrete Output: 8-point, sinking.
BX-DM1E-18ED23-D	BRX Do-more PLC, 12-24 VDC required, Ethernet and serial ports, microSD card slot, Discrete Input: 10-point, AC/DC, Analog Input: 1-channel, current/voltage, Discrete Output: 8-point, sourcing, Analog Output: 1-channel, current/voltage.
BX-DM1E-18ED13-D	BRX Do-more PLC, 12-24 VDC required, Ethernet and serial ports, microSD card slot, Discrete Input: 10-point, AC/DC, Analog Input: 1-channel, current/voltage, Discrete Output: 8-point, sinking, Analog Output: 1-channel, current/voltage.
BX-DM1-18ED2	BRX Do-more PLC, 120-240 VAC required, serial port, microSD card slot, Discrete Input: 10-point, AC/DC, Discrete Output: 8-point, sourcing.
BX-DM1-18ED1	BRX Do-more PLC, 120-240 VAC required, serial port, microSD card slot, Discrete Input: 10-point, AC/DC, Discrete Output: 8-point, sinking.

Table continued next page.

<i>BRX Series PLCs/Modules for Use with SureStep Drives</i>	
BX-DM1E-18ED23	BRX Do-more PLC, 120-240 VAC required, Ethernet and serial ports, microSD card slot, Discrete Input: 10-point, AC/DC, Analog Input: 1-channel, current/voltage, Discrete Output: 8-point, sourcing, Analog Output: 1-channel, current/voltage.
BX-DM1E-18ED13	BRX Do-more PLC, 120-240 VAC required, Ethernet and serial ports, microSD card slot, Discrete Input: 10-point, AC/DC, Analog Input: 1-channel, current/voltage, Discrete Output: 8-point, sinking, Analog Output: 1-channel, current/voltage.
BX-DM1-36ED2-D	BRX Do-more PLC, 12-24 VDC required, serial port, microSD card slot, Discrete Input: 20-point, AC/DC, Discrete Output: 16-point, sourcing.
BX-DM1-36ED1-D	BRX Do-more PLC, 12-24 VDC required, serial port, microSD card slot, Discrete Input: 20-point, AC/DC, Discrete Output: 16-point, sinking.
BX-DM1E-36ED23-D	BRX Do-more PLC, 12-24 VDC required, Ethernet and serial ports, microSD card slot, Discrete Input: 20-point, AC/DC, Analog Input: 4-channel, current/voltage, Discrete Output: 16-point, sourcing, Analog Output: 2-channel, current/voltage.
BX-DM1E-36ED13-D	BRX Do-more PLC, 12-24 VDC required, Ethernet and serial ports, microSD card slot, Discrete Input: 20-point, AC/DC, Analog Input: 4-channel, current/voltage, Discrete Output: 16-point, sinking, Analog Output: 2-channel, current/voltage.
BX-DM1-36ED2	BRX Do-more PLC, 120-240 VAC required, serial port, microSD card slot, Discrete Input: 20-point, AC/DC, Discrete Output: 16-point, sourcing.
BX-DM1-36ED1	BRX Do-more PLC, 120-240 VAC required, serial port, microSD card slot, Discrete Input: 20-point, AC/DC, Discrete Output: 16-point, sinking.
BX-DM1E-36ED23	BRX Do-more PLC, 120-240 VAC required, Ethernet and serial ports, microSD card slot, Discrete Input: 20-point, AC/DC, Analog Input: 4-channel, current/voltage, Discrete Output: 16-point, sourcing, Analog Output: 2-channel, current/voltage.
BX-DM1E-36ED13	BRX Do-more PLC, 120-240 VAC required, Ethernet and serial ports, microSD card slot, Discrete Input: 20-point, AC/DC, Analog Input: 4-channel, current/voltage, Discrete Output: 16-point, sinking, Analog Output: 2-channel, current/voltage.
<i>Table continued next page.</i>	

<i>DirectLOGIC PLCs/Modules for Use with SureStep Drives (1)</i>	
DL05 PLCs	
D0-05AD	DL05 CPU, 8 AC in / 6 DC out, 110/220 VAC power supply. Inputs: 8 AC inputs, 90-120 VAC, 2 isolated commons. Outputs: 6 DC outputs, 6-27 VDC current sinking, 1.0 A/pt max, 1 common. Two outputs are configurable for independent CW/CCW pulse train output or step and direction pulse output up to 7kHz (0.5 A/pt.).
D0-05DD	DL05 CPU, 8 DC in / 6 DC out, 110/220 VAC power supply. Inputs: 8 DC inputs, 12-24 VDC current sinking/sourcing, 2 isolated commons. Outputs: 6 DC outputs, 6-27 VDC current sinking, 1.0 A/pt max, 1 common. Two outputs are configurable for independent CW/CCW pulse train output or step and direction pulse output up to 7kHz (0.5 A/pt) (not available when using high-speed inputs).
D0-05DD-D	DL05 CPU, 8 DC in / 6 DC out, 12/24 VDC power supply. Inputs: 8 DC inputs, 12-24 VDC current sinking/sourcing, 2 isolated commons. Outputs: 6 DC outputs, 6-27 VDC current sinking, 1.0 A/pt max, 1 common. Two outputs are configurable for independent CW/CCW pulse train output or step and direction pulse output up to 7kHz (0.5 A/pt.) (not available when using high-speed inputs).
DL06 PLCs	
D0-06DD1	DL06 CPU, 20 DC in / 16 DC out, 110/220 VAC power supply, with 0.3A 24 VDC auxiliary device power supply. Inputs: 20 DC inputs, 12-24 VDC current sinking/sourcing, 5 isolated commons (4 inputs per common). Outputs: 16 DC outputs, 12-24 VDC current sinking, 1.0A/pt max, 4 commons non-isolated (4 points per common). Two outputs are configurable for independent CW/CCW pulse train output or step and direction pulse output up to 10 kHz (0.5 A/pt) (not available when using high-speed inputs).
D0-06DD2	DL06 CPU, 20 DC in / 16 DC out, 110/220 VAC power supply, with 0.3A 24 VDC auxiliary device power supply. Inputs: 20 DC inputs, 12-24 VDC current sinking/sourcing, 5 isolated commons (4 inputs per common). Outputs: 16 DC outputs, 12-24 VDC current sourcing 1.0A/pt max, 4 commons non-isolated (4 points per common). Two outputs are configurable for independent CW/CCW pulse train output or step and direction pulse output up to 10 kHz (0.5 A/pt) (not available when using high-speed inputs).
D0-06DD1-D	DL06 CPU, 20 DC in / 16 DC out, 12/24 VDC power supply. Inputs: 20 DC inputs, 12-24 VDC current sinking/sourcing, 5 isolated commons (4 inputs per common). Outputs: 16 DC outputs, 12-24 VDC current sinking, 1.0 A/pt max, 4 commons non-isolated (4 pts/common). Two outputs are configurable for independent CW/CCW pulse train output or step and direction pulse output up to 10 kHz (0.5 A/pt) (not available when using high-speed inputs).
D0-06DD2-D	DL06 CPU, 20 DC in / 16 DC out, 12/24 VDC power supply. Inputs: 20 DC inputs, 12-24 VDC current sinking/sourcing, 5 isolated commons (4 inputs per common). Outputs: 16 DC outputs, 12-24VDC current sourcing, 1.0A/pt max, 4 commons non-isolated (4 pts/common). Two outputs are configurable for independent CW/CCW pulse train output or step and direction pulse output up to 10 kHz (0.5 A/pt) (not available when using high-speed inputs).
DL05/DL06 High Speed Counter I/O Module	
H0-CTRIO	DL05/06 High Speed Counter I/O Interface Module, 4 DC sink/source inputs 9-30 VDC, 2 isolated sink/source DC outputs, 5-30 VDC, 1A per point. Inputs supported: 1 quadrature encoder counters up to 100 kHz, or 2 single channel counters up to 100 kHz, and 2 high speed discrete inputs for Reset, Inhibit, or Capture. Outputs supported: 2 independently configurable high speed discrete outputs or 1 channel pulse output control, 20Hz-25kHz per channel, pulse and direction or CW/CCW pulses.

Table continued next page.

<i>DirectLOGIC PLCs/Modules for Use with SureStep Drives</i> ⁽¹⁾ (continued)	
DL105 PLCs	
F1-130AD	DL130 CPU, 10 AC in / 8 DC out, 110/220 VAC power supply. Inputs: 10 AC inputs, 80-132 VAC, 3 isolated commons. Outputs: 8 DC outputs, 5-30 VDC current sinking, 0.5A/pt max, 3 internally connected commons. Two outputs are configurable for independent CW/CCW pulse train output or step and direction pulse output up to 7kHz (@ 0.25 A/pt max).
F1-130DD	DL130 CPU, 10 DC in / 8 DC out, 110/220 VAC power supply. Inputs: 10 DC inputs, 12-24 VDC current sinking/sourcing, 3 isolated commons. Outputs: 8 DC outputs, 5-30 VDC current sinking, 0.5 A/pt max, 3 internally connected commons. Two outputs are configurable for independent CW/CCW pulse train output or step and direction pulse output up to 7kHz (@ 0.25 A/pt max) (not available when using high-speed inputs).
F1-130DD-D	DL130 CPU, 10 DC in / 8 DC out, 12/24 VDC power supply. Inputs: 10 DC inputs, 12-24 VDC current sinking/sourcing, 3 isolated commons. Outputs: 8 DC outputs, 5-30 VDC current sinking, 0.5 A/pt max, 3 internally connected commons. Two outputs are configurable for independent CW/CCW pulse train output or step and direction pulse output up to 7kHz (@ 0.25 A/pt max) (not available when using high-speed inputs).
DL205 and Do-More High Speed Counter I/O Modules	
H2-CTRIO2	DL205 High Speed Counter I/O Interface Module, 8 DC sink/source inputs 9-30 VDC, 4 isolated sink/source DC outputs, 5-30 VDC, 1A per point. Inputs supported: 2 quadrature encoder counters up to 100 kHz, or 4 single channel counters up to 100 kHz, and 4 high speed discrete inputs for Reset, Inhibit, or Capture. Outputs supported: 4 independently configurable high speed discrete outputs or 2 channels pulse output control, 20 Hz - 25 kHz per channel, pulse and direction or CW/CCW pulses.
D2-CTRINT	Counter Interface Module, 4 isolated DC inputs, 1 pulse train output (CW) or 2 pulse train outputs (CW/CCW) with DC input restrictions, accepts two up-counters when used with D2-240 or D2-250(-1) (one only with D2-230), or one up/down counter. (not available when using high-speed inputs).
Terminator I/O High Speed Counter I/O Module	
T1H-CTRIO	Terminator I/O High Speed Counter I/O Interface Module, 8 DC sink/source inputs 9-30 VDC, 4 isolated sink/source DC outputs, 5-30 VDC, 1A per point. Inputs supported: 2 quadrature encoder counters up to 100 kHz, or 4 single channel counters up to 100 kHz, and 4 high speed discrete inputs for Reset, Inhibit, or Capture. Outputs supported: 4 independently configurable high speed discrete outputs or 2 channels pulse output control, 20 Hz - 25 kHz per channel, pulse and direction or CW/CCW pulses. (Use with T1K-16B or T1K-16B-1 terminal base.)
DL405 High Speed Counter I/O Module	
H4-CTRIO	DL405 High Speed Counter I/O Interface Module, 8 DC sink/source inputs 9-30 VDC, 4 isolated sink/source DC outputs, 5-30 VDC, 1A per point. Inputs supported: 2 quadrature encoder counters up to 100 kHz, or 4 single channel counters up to 100 kHz, and 4 high speed discrete inputs for Reset, Inhibit, or Capture. Outputs supported: 4 independently configurable high speed discrete outputs or 2 channels pulse output control, 20 Hz - 25 kHz per channel, pulse and direction or CW/CCW pulses.
<i>(1) Any DirectLOGIC PLC capable of RS-232 ASCII communication can write serial commands to the SureStep Advanced Microstepping Drives (STP-DRV-4850 & -80100). These PLCs include DL 05, 06, 250-1, 260, 350, and 450/454. However, we strongly recommend using DL06 or DL260 PLCs for serial commands due to their more advanced ASCII instruction set which includes PRINTV and VPRINT commands.</i>	

Typical Connections to a Productivity PLC

The following wiring diagrams show typical connections between any SureStep Drive or Integrated motor/drive and a Productivity P3-HSO or P2-HSO (wiring is identical). All SureStep drives can be wired for Line Driver signals (preferred for noise immunity) or Open Collector. Refer to the Productivity User Manual for detailed programming instructions when using the HSO module.

Line Driver/Differential Wiring (preferred)

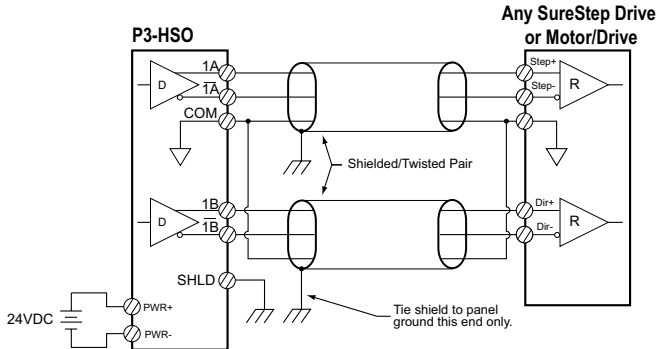

Open Collector/Single-ended wiring

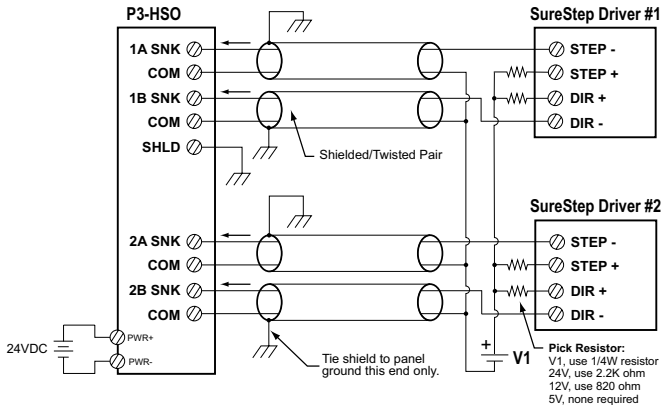

A voltage dropping resistor is only needed if the PLC cannot generate 5VDC high speed pulses and the drive can only accept 5VDC pulses. These resistor values result in a 10mA signal [Amps = Volts/(internal drive R + external R)]. Other values can be used, but ensure that [5mA < signal current < 15mA]. See the individual drive chapters for more information.

Typical Connections to a DL05 PLC

The following wiring diagram shows typical connections between the *SureStep* Stepping System components and a *DirectLOGIC* DL05 PLC. Refer to the DL05 Micro PLC User Manual, p/n D0-USER-M, High-Speed Input and Pulse Output Features chapter, for detailed programming instructions when using the PLC for the Mode 30: Pulse Output function.

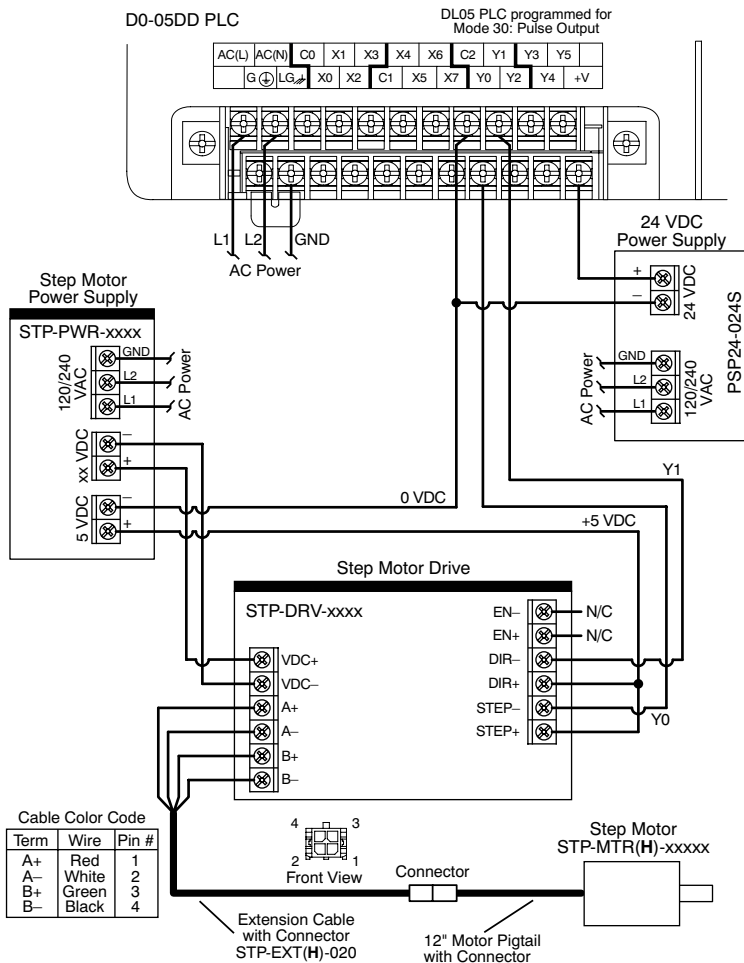

Typical Connections to an H0-CTRIO

The following wiring diagram shows typical connections between the *SureStep* Stepping System components and a *DirectLOGIC* H0-CTRIO High Speed Counter I/O Interface Module installed in either a DL05 or DL06 PLC option slot. Refer to the CTRIO High-Speed Counter Module User Manual, p/n Hx-CTRIO-M, for detailed programming instructions when using the H0-CTRIO module.

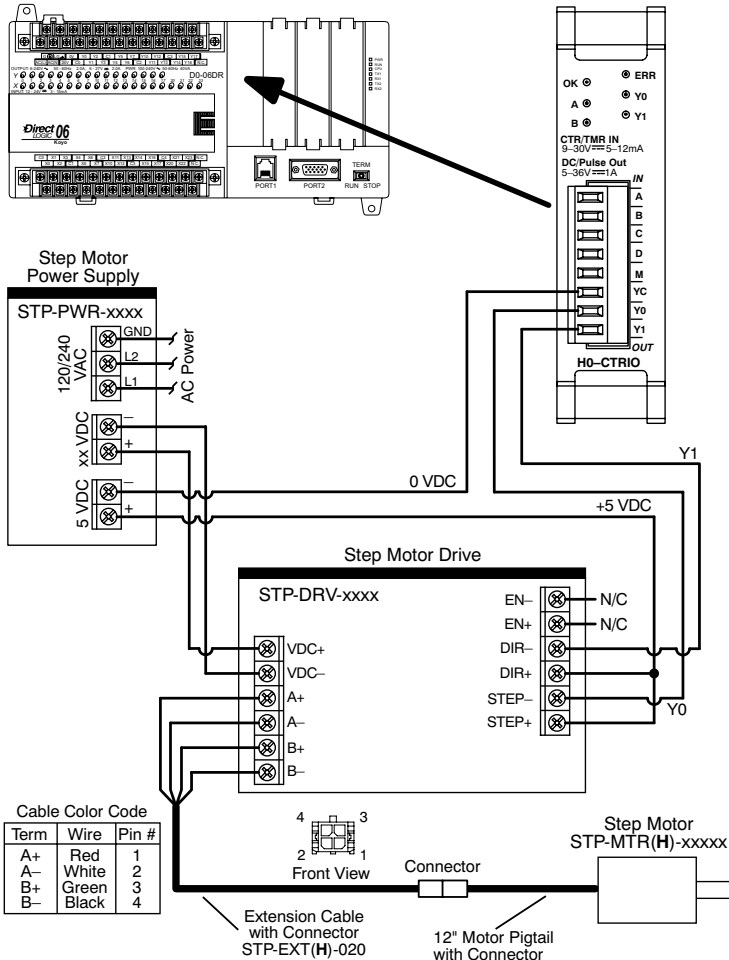

Typical Connections – Multiple Drives/Motors

The following wiring diagram shows typical connections between the *SureStep* Stepping System components and a *DirectLOGIC* H2-CTRIO(2) High Speed Counter I/O Interface Module installed in a DL205 PLC. Refer to the CTRIO High-Speed Counter Module User Manual, p/n Hx-CTRIO-M, for detailed programming instructions when using the H2-CTRIO module.

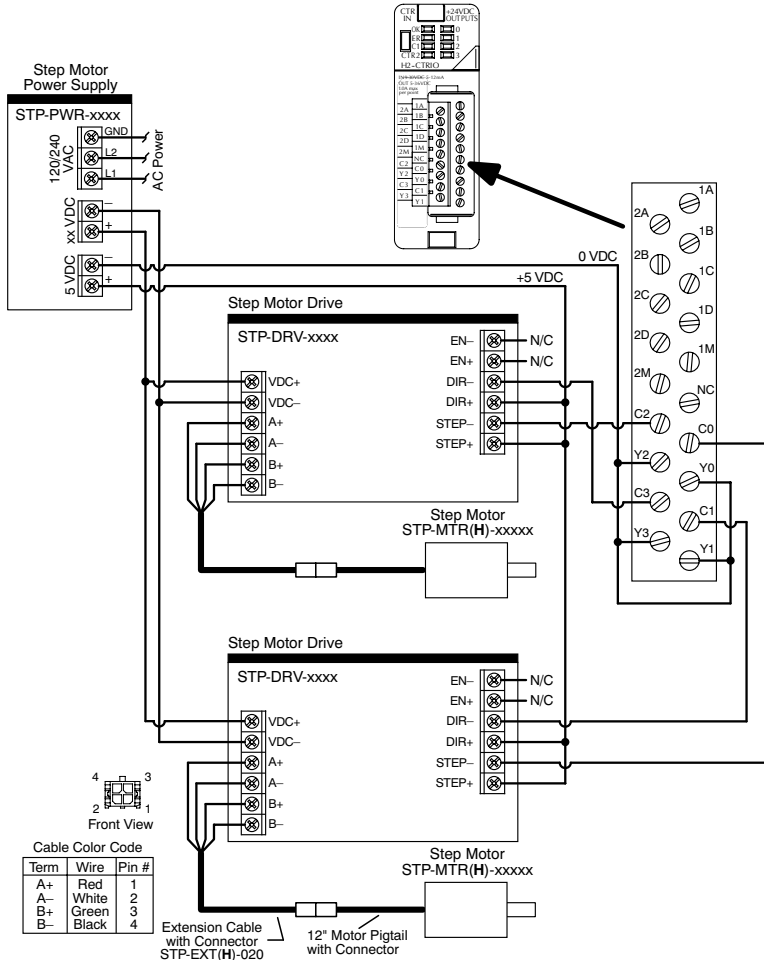

Typical *Direct*LOGIC PLC RS-232 Serial Connections to an Advanced SureStep Drive

The following wiring diagrams show typical serial connections between a *SureStep* Advanced Microstepping Drive and a *Direct*LOGIC PLC capable of RS-232 ASCII communication. Refer to the particular PLC user manual for instructions for writing ASCII serial commands.

Serial Connection Using Automation Direct Cables

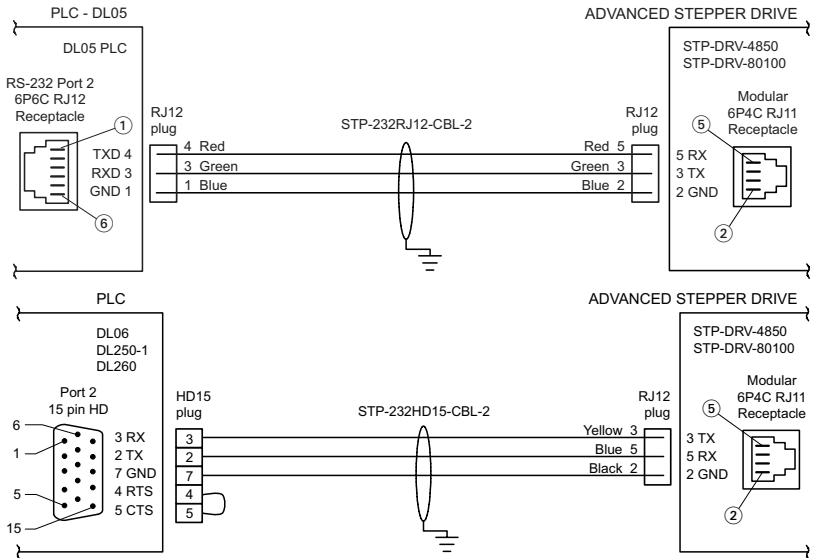

Serial Connection Using Custom Cables

Use Belden 9841 or equivalent cable, and wire according to the Automation Direct cable diagrams shown above (including RTS/CTS jumper for DL06, DL250-1, and DL260).

Typical CLICK, P-Series, & BRX PLC RS-232 Serial Connections to an Advanced SureStep Drive

The following wiring diagrams show typical serial connections between a *SureStep* Advanced Microstepping Drive and a CLICK, BRX, or P1/P2/P3 PLC capable of RS-232 ASCII communication. Refer to the particular PLC user manual for instructions for writing ASCII serial commands.

Serial Connection Using Automation Direct Cables

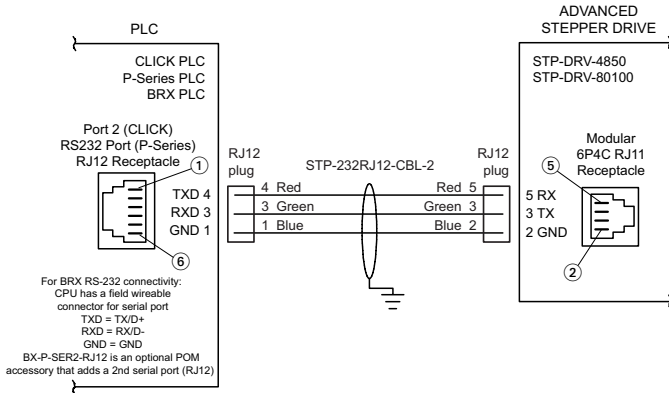

Serial Connection Using Custom Cables

Use Belden 9841 or equivalent cable, and wire according to the Automation Direct STP-232RJ12-CBL-2 diagram shown above.

Typical RS-485 Connections to Integrated Motor/Drives

Most AutomationDirect PLCs support 2-wire RS-485 serial communication (3 wires on the connector: Transmit (+), Receive (-), and Ground). For 2-wire communication, the integrated motor/drive must have its Tx+ and Rx+ connected; and Tx- and Rx- connected.

- The drive's Tx+/Rx+ signal should be connected to the "+" connection of the PLC's RS-485 port.
- The drive's Tx-/Rx- signal should be connected to the "-" connection of the PLC's RS-485 port.
- The drive's RS-485 ground terminal should be connected to the PLC's serial port ground terminal.

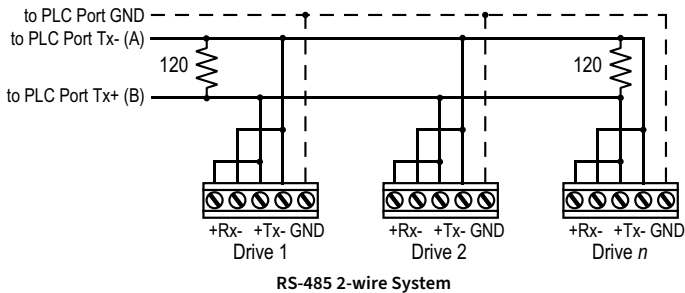

<i>Terminal Connections per PLC</i>			
Drive Connection	CLICK	P-Series	BRX
Tx+, Rx+	+	+	TX/D+
Tx-, Rx-	-	-	RX/D-
GND	LG	G	GND

SELECTING THE SureStep™ STEPPING SYSTEM



In This Appendix...

Selecting the SureStep™ Stepping System	C-2
The Selection Procedure	C-2
How many pulses from the PLC to make the move?	C-2
What is the positioning resolution of the load?	C-3
What is the indexing speed to accomplish the move time?	C-3
Calculating the Required Torque	C-4
Leadscrew – Example Calculations	C-8
Step 1 – Define the Actuator and Motion Requirements	C-8
Step 2 – Determine the Positioning Resolution of the Load	C-9
Step 3 – Determine the Motion Profile	C-9
Step 4 – Determine the Required Motor Torque	C-9
Step 5 – Select & Confirm the Stepping Motor & Driver System	C-10
Belt Drive – Example Calculations	C-15
Step 1 – Define the Actuator and Motion Requirements	C-15
Step 2 – Determine the Positioning Resolution of the Load	C-16
Step 3 – Determine the Motion Profile	C-16
Step 4 – Determine the Required Motor Torque	C-16
Step 5 – Select & Confirm the Stepping Motor & Driver System	C-17
Index Table – Example Calculations	C-19
Step 1 – Define the Actuator and Motion Requirements	C-19
Step 2 – Determine the Positioning Resolution of the Load	C-19
Step 3 – Determine the Motion Profile	C-20
Step 4 – Determine the Required Motor Torque	C-20
Step 5 – Select & Confirm the Stepping Motor & Driver System	C-21
Engineering Unit Conversion Tables, Formulae, & Definitions:	C-22

Selecting the SureStep™ Stepping System

The selection of your SureStep™ stepping system follows a defined process. Let's go through the process and define some useful relationships and equations. We will use this information to work some typical examples along the way.

The Selection Procedure

The motor provides for the required motion of the load through the actuator (mechanics that are between the motor shaft and the load or workpiece). Key information to accomplish the required motion is:

- total number of pulses from the PLC
- positioning resolution of the load
- indexing speed (or PLC pulse frequency) to achieve the move time
- required motor torque (including the 100% safety factor)
- load to motor inertia ratio

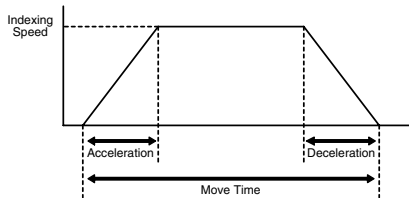

In the final analysis, we need to achieve the required motion with acceptable positioning accuracy.

How many pulses from the PLC to make the move?

The total number of pulses to make the entire move is expressed with the equation:

$$\text{Equation 1: } P_{\text{total}} = \text{total pulses} = (D_{\text{total}} \div (d_{\text{load}} \div i)) \times \theta_{\text{step}}$$

D_{total} = total move distance

d_{load} = lead or distance the load moves per revolution of the actuator's drive shaft
(P = pitch = $1/d_{\text{load}}$)

θ_{step} = driver step resolution (steps/rev_{motor})

i = gear reduction ratio (rev_{motor}/rev_{gearshaft})

Example 1: The motor is directly attached to a disk, the stepping driver is set at 400 steps per revolution and we need to move the disk 5.5 revolutions. How many pulses does the PLC need to send the driver?

$$\begin{aligned} P_{\text{total}} &= (5.5 \text{ rev}_{\text{disk}} \div (1 \text{ rev}_{\text{disk}}/\text{rev}_{\text{driveshaft}} \div 1 \text{ rev}_{\text{motor}}/\text{rev}_{\text{driveshaft}})) \\ &\quad \times 400 \text{ steps}/\text{rev}_{\text{motor}} \\ &= 2200 \text{ pulses} \end{aligned}$$

Example 2: The motor is directly attached to a ballscrew where one turn of the ballscrew results in 10 mm of linear motion, the stepping driver is set for 1000 steps per revolution, and we need to move 45 mm. How many pulses do we need to send the driver?

$$P_{\text{total}} = (45 \text{ mm} \div (10 \text{ mm/rev}_{\text{screw}} \div 1 \text{ rev}_{\text{motor}}/\text{rev}_{\text{screw}})) \times 1000 \text{ steps/rev}_{\text{motor}} \\ = 4500 \text{ pulses}$$

Example 3: Let's add a 2:1 belt reduction between the motor and ballscrew in example 2. Now how many pulses do we need to make the 45 mm move?

$$P_{\text{total}} = (45 \text{ mm} \div (10 \text{ mm/rev}_{\text{screw}} \div 2 \text{ rev}_{\text{motor}}/\text{rev}_{\text{screw}})) \times 1000 \text{ steps/rev}_{\text{motor}} \\ = 9000 \text{ pulses}$$

What is the positioning resolution of the load?

We want to know how far the load will move for one pulse or step of the motor shaft. The equation to determine the positioning resolution is:

$$\text{Equation 2: } L_{\theta} = \text{load positioning resolution} = (d_{\text{load}} \div i) \div \theta_{\text{step}}$$

Example 4: What is the positioning resolution for the system in example 3?

$$L_{\theta} = (d_{\text{load}} \div i) \div \theta_{\text{step}} \\ = (10 \text{ mm/rev}_{\text{screw}} \div 2 \text{ rev}_{\text{motor}}/\text{rev}_{\text{screw}}) \div 1000 \text{ steps/rev}_{\text{motor}} \\ = 0.005 \text{ mm/step} \\ \approx 0.0002 \text{ in/step}$$

What is the indexing speed to accomplish the move time?

The most basic type of motion profile is a "start-stop" profile where there is no acceleration or deceleration period. This type of motion profile is only used for low speed applications because the load is "jerked" from one speed to another and the stepping motor will stall or drop pulses if excessive speed changes are attempted. The equation to find indexing speed for "start-stop" motion is:

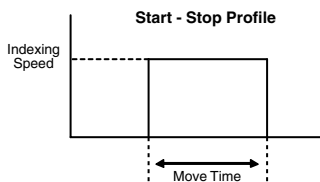

$$\text{Equation 3: } f_{\text{SS}} = \text{indexing speed for start-stop profiles} = P_{\text{total}} \div t_{\text{total}} \\ t_{\text{total}} = \text{move time}$$

Example 5: What is the indexing speed to make a “start-stop” move with 10,000 pulses in 800 ms?

$$f_{SS} = \text{indexing speed} = P_{\text{total}} \div t_{\text{total}} = 10,000 \text{ pulses} \div 0.8 \text{ seconds} \\ = 12,500 \text{ Hz}$$

For higher speed operation, the “trapezoidal” motion profile includes controlled acceleration & deceleration and an initial non-zero starting speed. With the acceleration and deceleration periods equally set, the indexing speed can be found using the equation:

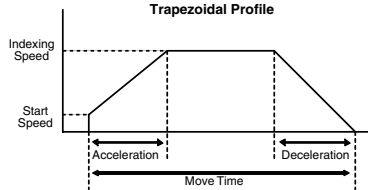

Equation 4: $f_{TRAP} = (P_{\text{total}} - (f_{\text{start}} \times t_{\text{ramp}})) \div (t_{\text{total}} - t_{\text{ramp}})$
for trapezoidal motion profiles

f_{start} = starting speed

t_{ramp} = acceleration or deceleration time

Example 6: What is the required indexing speed to make a “trapezoidal” move in 800ms, accel/decel time of 200 ms each, 10,000 total pulses, and a starting speed of 40 Hz?

$$f_{TRAP} = (10,000 \text{ pulses} - (40 \text{ pulses/sec} \times 0.2 \text{ sec})) \div (0.8 \text{ sec} - 0.2 \text{ sec}) \\ \approx 16,653 \text{ Hz}$$

Calculating the Required Torque

The required torque from the stepping system is the sum of acceleration torque and the running torque. The equation for required motor torque is:

Equation 5: $T_{\text{motor}} = T_{\text{accel}} + T_{\text{run}}$

T_{accel} = motor torque required to accelerate and decelerate the total system inertia (including motor inertia)

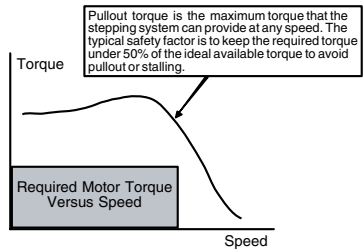

T_{run} = constant motor torque requirement to run the mechanism due to friction, external load forces, etc.

In **Table 1** we show how to calculate torque required to accelerate or decelerate an inertia from one speed to another and the calculation of running torque for common mechanical actuators.

Table 1 – Calculate the Torque for “Acceleration” and “Running”

The torque required to accelerate or decelerate an inertia with a linear change in velocity is:

$$\text{Equation 6: } T_{\text{accel}} = J_{\text{total}} \times (\Delta\text{speed} \div \Delta\text{time}) \times (2\pi + 60)$$

J_{total} is the motor inertia, plus load inertia (“reflected” to the motor shaft). The $(2\pi + 60)$ is a factor used to convert “change in speed” expressed in RPM into angular speed (radians/second). Refer to information in this table to calculate “reflected” load inertia for several common shapes and mechanical mechanisms.

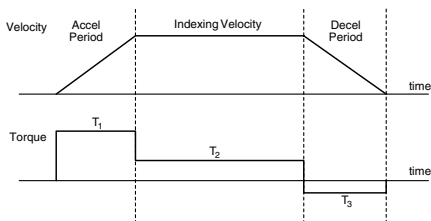

Example 7: What is the required torque to accelerate an inertia of 0.002 lb·in·sec² (motor inertia is 0.0004 lb·in·sec² and “reflected” load inertia is 0.0016 lb·in·sec²) from zero to 600 RPM in 50 ms?

$$T_{\text{accel}} = 0.002 \text{ lb}\cdot\text{in}\cdot\text{sec}^2 \times (600 \text{ RPM} \div 0.05 \text{ seconds}) \times (2\pi + 60) \\ \approx 2.5 \text{ lb}\cdot\text{in}$$

Leadscrew Equations

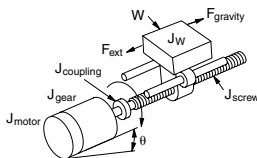

Description:	Equations:
Motor RPM	$n_{\text{motor}} = (v_{\text{load}} \times P) \times i$, n_{motor} (RPM), v_{load} (in/min)
Torque required to accelerate and decelerate the load	$T_{\text{accel}} = J_{\text{total}} \times (\Delta\text{speed} \div \Delta\text{time}) \times 0.1$
Motor total inertia	$J_{\text{total}} = J_{\text{motor}} + J_{\text{gear}} + ((J_{\text{coupling}} + J_{\text{screw}} + J_{\text{W}}) \div i^2)$
Inertia of the load	$J_{\text{W}} = (W \div (g \times e)) \times (1 + 2\pi P)^2$
Pitch and Efficiency	$P = \text{pitch} = \text{revs/inch of travel}$, $e = \text{efficiency}$
Running torque	$T_{\text{run}} = ((F_{\text{total}} \div (2\pi P)) + T_{\text{preload}}) \div i$
Torque due to preload on the ballscrew	$T_{\text{preload}} = \text{ballscrew nut preload to minimize backlash}$
Force total	$F_{\text{total}} = F_{\text{ext}} + F_{\text{friction}} + F_{\text{gravity}}$
Force of gravity and Force of friction	$F_{\text{gravity}} = W \sin\theta$, $F_{\text{friction}} = \mu W \cos\theta$
Incline angle and Coefficient of friction	$\theta = \text{incline angle}$, $\mu = \text{coefficient of friction}$

Table 1 (cont'd)			
Typical Leadscrew Data			
Material:	e = efficiency	Material:	μ = coef. of friction
ball nut	0.90	steel on steel	0.580
acme with plastic nut	0.65	steel on steel (lubricated)	0.150
acme with metal nut	0.40	teflon on steel	0.040
		ball bushing	0.003

Belt Drive (or Rack & Pinion) Equations	
Description:	Equations:
Motor RPM	$n_{motor} = (v_{load} \times 2 \pi r) \times i$
Torque required to accelerate and decelerate the load	$T_{accel} = J_{total} \times (\Delta speed \div \Delta time) \times 0.1$
Inertia of the load	$J_{total} = J_{motor} + J_{gear} + ((J_{pinion} + J_W) \div i^2)$
Inertia of the load	$J_W = (W \div (g \times e)) \times r^2$; $J_{W2} = ((W1 + W2) \div (g \times e)) \times r^2$
Radius of pulleys	$r = \text{radius of pinion or pulleys (inch)}$
Running torque	$T_{run} = (F_{total} \times r) \div i$
Force total	$F_{total} = F_{ext} + F_{friction} + F_{gravity}$
Force of gravity and Force of friction	$F_{gravity} = W \sin \theta$; $F_{friction} = \mu W \cos \theta$

Belt (or Gear) Reducer Equations	
Description:	Equations:
Motor RPM	$n_{motor} = n_{load} \times i$
Torque required to accelerate and decelerate the load	$T_{accel} = J_{total} \times (\Delta speed \div \Delta time) \times 0.1$
Inertia of the load	$J_{total} = J_{motor} + J_{motorpulley} + ((J_{loadpulley} + J_{Load}) \div i^2)$
Motor torque	$T_{motor} \times i = T_{Load}$

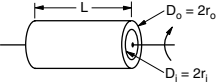
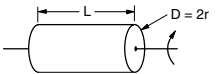
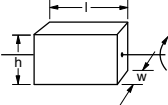
Table 1 (cont'd)	
Inertia of Hollow Cylinder Equations	
	
Description:	Equations:
Inertia	$J = (W \times (r_o^2 + r_i^2)) \div (2g)$
Inertia	$J = (\pi \times L \times \rho \times (r_o^4 - r_i^4)) \div (2g)$
Volume	volume = $\pi/4 \times (D_o^2 - D_i^2) \times L$
Inertia of Solid Cylinder Equations	
	
Description:	Equations:
Inertia	$J = (W \times r^2) \div (2g)$
Inertia	$J = (\pi \times L \times \rho \times r^4) \div (2g)$
Volume	volume = $\pi \times r^2 \times L$
Inertia of Rectangular Block Equations	
	
Description:	Equations:
Inertia	$J = (W \div 12g) \times (h^2 + w^2)$
Volume	volume = $l \times h \times w$
Symbol Definitions	
J = inertia	ρ = density
L = Length	$\rho = 0.098 \text{ lb/in}^3$ (aluminum)
h = height	$\rho = 0.28 \text{ lb/in}^3$ (steel)
w = width	$\rho = 0.04 \text{ lb/in}^3$ (plastic)
W = weight	$\rho = 0.31 \text{ lb/in}^3$ (brass)
D = diameter	$\rho = 0.322 \text{ lb/in}^3$ (copper)
r = radius	
g = gravity = 386 in/sec ²	$\pi \approx 3.14$

Leadscrew – Example Calculations

Step 1 – Define the Actuator and Motion Requirements

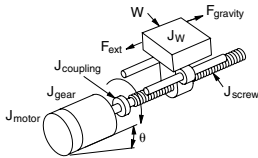

Weight of table and workpiece = 200 lb, where $W = 200$ lb

Angle of inclination = 0°

Friction coefficient of sliding surfaces = 0.05, where $\mu = 0.05$

External load force = 0

Ball screw shaft diameter = 0.6 inch

Ball screw length = 23.6 inch

Ball screw material = steel

Ball screw lead = 0.6 inch/rev, where $P = 1/0.6 = 1.67$ rev/in

Desired Resolution = 0.001 inch/step

Gear reducer = 2:1, where $i = 2$, preliminary (for the 3:1 example, $i = 3$)

Stroke = 4.5 inch

Move time = 1.7 seconds

Acceleration time = Deceleration time = $0.425 \text{ sec} / 2 = 212.5 \text{ ms}$

Lead screw efficiency = 0.9, where $e = 0.9$

Coupling and gear reducer inertias are negligible, which are considered to be 0

Definitions

d_{load} = lead or distance the load moves per revolution of the actuator's drive shaft ($P = \text{pitch} = 1/d_{\text{load}}$)

D_{total} = total move distance

θ_{step} = driver step resolution (steps/rev_{motor})

i = gear reduction ratio (rev_{motor}/rev_{gearshaft})

T_{accel} = motor torque required to accelerate and decelerate the total system inertia (including motor inertia)

T_{run} = constant motor torque requirement to run the mechanism due to friction, external load forces, etc.

t_{total} = move time

Start frequency = 20 Hz (as defined with a Module H0-CTRIO)

Step 2 – Determine the Positioning Resolution of the Load

One revolution of the lead screw shaft advances 0.6 inches. We are looking for a 0.001 inch per step precision.

Check to see if 400 pulses/rev will achieve the desired precision:

- With a reduction of 2:1, there will be two motor shaft revolutions to get a displacement of 0.6 inches.
- $(2 \text{ rev}) \times (400 \text{ pulses/rev}) = 800 \text{ pulses}$ for every 0.6 inches of displacement.
- Therefore, $(0.6 \text{ in}) / (800 \text{ pulses}) = 0.00075 \text{ in/pulse}$.
- This is within the desired 0.001 in/step.

How many pulses are needed for the displacement?

- With the 2:1 gear reduction, the stepping system can be set at 400 steps/rev to exceed the required load positioning resolution.
- Since the lead screw advances 0.6 inches / rev, in the required stroke of 4.5 inches we will need:
 $(4.5 \text{ in}) / (0.6 \text{ rev/in}) = 7.5 \text{ revolutions}$ on the lead screw
- Since we have a reduction of 2:1, the motor shaft shall rotate 15 revolutions.

Step 3 – Determine the Motion Profile

Since we know that 400 pulses gets one revolution on the motor and we need 15 revolutions, then $400 \times 15 = 6,000$ pulses to move 4.5 inches.

From **Equation 4**, the indexing frequency for a trapezoidal move is:

- $f_{\text{TRAP}} = \frac{(P_{\text{total}} - (f_{\text{start}} \times t_{\text{ramp}})) + (t_{\text{total}} - t_{\text{ramp}})}{}$
 $= \frac{(6,000 - (20 \times 0.425\text{s})) + (1.7 - 0.425)}{}$ = 4,699 Hz,
 where the starting speed is 20 Hz
- $(4,699 \text{ Hz}) / (400 \text{ steps/rev}) = 11.7475 \text{ rev/s}$
- To get it in rpm, $(11.7475 \text{ rev/s}) \times (60 \text{ s/min}) = 704.85 \text{ rpm}$.

Step 4 – Determine the Required Motor Torque

Using the equations in **Table 1**:

(Total inertia seen by the motor is the sum of all inertias)

$$J_{\text{total}} = J_{\text{motor}} + J_{\text{gear}} + (J_{\text{coupling}} + J_{\text{screw}} + J_{\text{W}}) \div i^2$$

For this example, we assume the gearbox and coupling inertias are zero.

Load inertia:

$$J_{\text{W}} = \frac{(W \div (g \times e)) \times (1 + 2\pi P)^2}{}$$

$$= \frac{(200 \div (386 \times 0.9)) \times (1 + 2 \times 3.1416 \times 1.67)^2}{}$$

$$= 0.00523 \text{ lb-in-sec}^2$$

Lead screw inertia:

$$J_{\text{screw}} = \frac{(\pi \times L \times r \times r^4) + (2g)}{}$$

$$= \frac{(3.1416 \times 23.6 \times 0.28 \times 0.3^4) + (2 \times 386)}{}$$

$$= 0.0002178 \text{ lb-in-sec}^2$$

The inertia of the load and screw reflected to the motor is the sum of both values divided by the square of the reduction ratio

$$J_{\text{(screw + load)}} \text{ referred to motor} = (J_{\text{screw}} + J_{\text{W}}) \div i^2$$

$$J_{\text{total less the motor inertia}} = ((0.0002178 + 0.00523) \div 2^2) = 0.001362 \text{ lb-in-sec}^2$$

The dynamic torque required to accelerate the inertia (without the motor rotor inertia) is:

$$\begin{aligned} T_{\text{accel}} &= J_{\text{total}} \times ((\Delta_{\text{rpm}} \div \Delta_{\text{time}}) \times (2\pi \div 60)) \\ &= 0.001362 \times ((704.85 \div 0.2125) \times (2 \times 3.1416 \div 60)) \\ &= 0.474309 \text{ lb}\cdot\text{in} \end{aligned}$$

Determine the running torque, or in this case the friction torque:

The forces are:

$$\begin{aligned} F_{\text{total}} &= F_{\text{ext}} + F_{\text{friction}} + F_{\text{gravity}} \quad [\text{External forces and gravity are zero in this case.}] \\ &= 0 + (\mu \times W \times \cos\theta) + 0 \\ &= 0.05 \times 200 = 10 \text{ lb} \end{aligned}$$

And the formula to be used is:

$$\begin{aligned} T_{\text{run}} &= ((F_{\text{total}} \div (2\pi P)) + T_{\text{preload}}) \div i \\ &= (10 \div (2 \times 3.1416 \times 1.67)) \div 2 \quad [\text{related to the motor side}] \\ &= 0.4765 \text{ lb}\cdot\text{in} \quad [\text{where, we have assumed the preload torque to be zero}] \end{aligned}$$

From **Equation 5**, the minimum required motor torque @ 704.85 rpm is:

$$\begin{aligned} T_{\text{motor}} &= T_{\text{accel}} + T_{\text{run}} \\ &= (0.474309 \text{ lb}\cdot\text{in}) + (0.4765 \text{ lb}\cdot\text{in}) \\ &= 0.9508 \text{ lb}\cdot\text{in}, \text{ or } 15.21 \text{ oz}\cdot\text{in} \end{aligned}$$

However, this is the required motor torque before we have picked a motor and included the motor inertia.

Step 5 – Select & Confirm the Stepping Motor & Driver System

There are two commonly used criteria to select a motor and drive:

- Take into account the calculated torque. From step 4, we find we need 15.21 oz-in.
- Per a rule of thumb, the load to motor inertia ratio should be kept below 10.
- In step 4 we calculated that the $J_{(\text{screw} + \text{load})} = 0.001362 \text{ lb}\cdot\text{in}\cdot\text{sec}^2$. To find the ratio, we use the formula: $J_{(\text{screw} + \text{load})} \div J_{\text{motor}}$. The inertia of the motor is found in the motor specifications sheet.

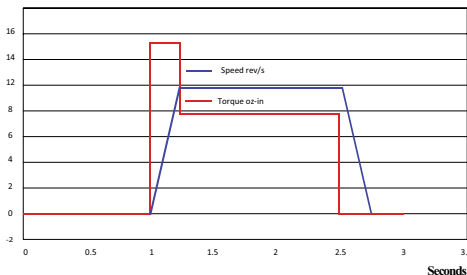

We will check the criteria with 2 motors:

Figure 2 shows the Torque vs. Speed curves for STP-MTR-17040 and figure 3 shows STP-MTR-17048. We use this as an example to observe how different power supply voltages affect the torque output of a motor.

Consider STP-MTR-17040:

STP-MTR-17040 Torque vs Speed (1.8° step motor; 1/2 stepping)

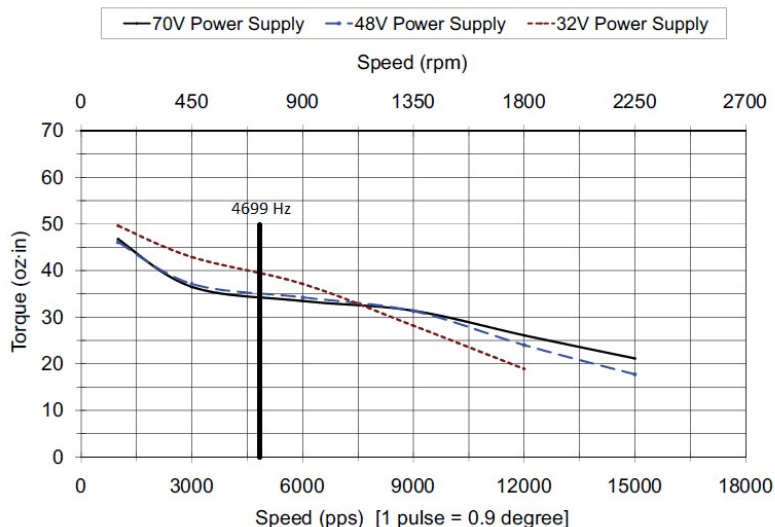

Figure 2: Torque for STP-MTR-17040 at 4.7 kHz

According to the torque/speed curves for this motor, the torque at 4.7 kHz is approximately 39 oz-in at 48VDC and 34 oz-in at 70VDC. Based on the torque, this motor meets the desired 15.21 oz-in with any power supply.

The rotor inertia, per the motor specification is 0.28 oz-in² or 0.0000454 lb-in-sec².

Load/Motor inertia ratio:

$$J(\text{screw} + \text{load}) \div J_{\text{motor}} = 0.001362 \text{ lb-in-sec}^2 \div 0.0000454 \text{ lb-in-sec}^2 = 30$$

The ratio of 30 is well above the desired ratio of 10, so the STP-MTR-17040 motor is not suitable.

Consider STP-MTR-17048:

STP-MTR-17048 Torque vs Speed (1.8° step motor; 1/2 stepping)

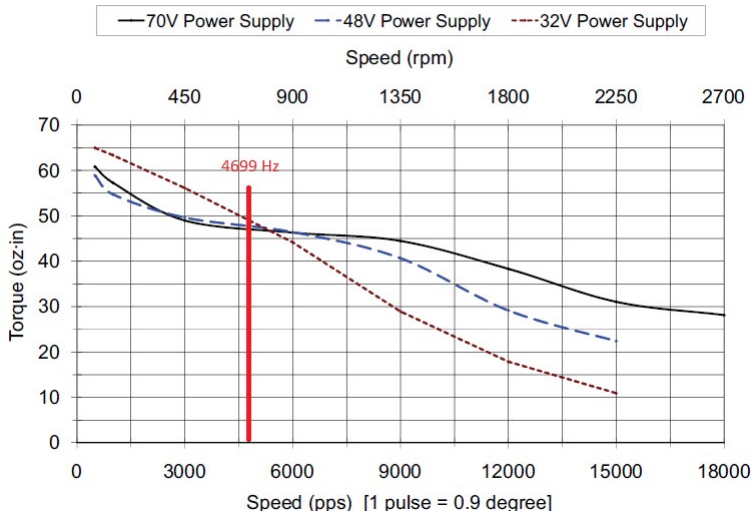

Figure 3: Torque for STP-MTR-17048 at 4.7 kHz

For the purpose of this example, the torque vs. speed curves for this motor at 4.7 kHz will be approximately 48 oz-in at 48VDC, and 46 oz-in at 70VDC. This motor also meets the desired 15.21 oz-in requirement.

The rotor inertia, per the motor specification is 0.45 oz-in² or 0.000024 lb-in·sec². Load/Motor inertia ratio:

$$J_{(\text{screw} + \text{load})} + J_{\text{motor}} = 0.001362 \text{ lb-in}\cdot\text{sec}^2 + 0.000024 \text{ lb-in}\cdot\text{sec}^2 = 18.683$$

The ratio of 18.683 is still above the desired ratio of 10, so the STP-MTR-17048 motor is not suitable.

We can keep increasing the motor size, or maybe change the reflected load inertia by changing the reduction ratio from 2:1 to 3:1.

Reduction Ratio 3:1 (Step 2 revisited) – Determine the Positioning Resolution of the Load

One revolution of the lead screw shaft advances 0.6 inches. We are looking for a 0.001 inch per step precision.

Check to see if 400 pulses/rev will achieve the desired precision:

- With a reduction of 3:1, there will be three motor shaft revolutions to get a displacement of 0.6 inches.

- (3 rev) x (400 pulses/rev) = 1200 pulses for every 0.6 inches of displacement.
- Therefore, (0.6 in) / (1200 pulses) = 0.0005 in/pulse.
- This is within the desired 0.001 in/step.

How many pulses are needed for the displacement?

- With the 3:1 gear reduction, the stepping system can be set at 400 steps/rev to exceed the required load positioning resolution.
- Since the lead screw advances 0.6 inches / rev, in the required stroke of 4.5 inches we will need:
 $(4.5 \text{ in}) / (0.6 \text{ rev/in}) = 7.5 \text{ revolutions on the lead screw}$
- Since we have a reduction of 3:1, the motor shaft shall rotate 22.5 revolutions.

Reduction Ratio 3:1 (Step 3 revisited) – Determine the Motion Profile

Since we know that 400 pulses gets one revolution on the motor and we need 22.5 revolutions, then $400 \times 22.5 = 9,000$ pulses to move 4.5 inches.

From **Equation 4**, the indexing frequency for a trapezoidal move is:

- $f_{\text{TRAP}} = \frac{(P_{\text{total}} - (f_{\text{start}} \times t_{\text{ramp}})) + (t_{\text{total}} - t_{\text{ramp}})}{(9,000 - (20 \times 0.425\text{s})) \div (1.7 - 0.425)} = 8,991.5 \text{ Hz}$,
 where the starting speed is 20Hz
- $(8,991.5 \text{ Hz}) / (400 \text{ steps/rev}) = 22.48 \text{ rev/s}$
- To get it in rpm, $(22.48 \text{ rev/s}) \times (60 \text{ s/min}) = 1349 \text{ rpm}$.

Reduction Ratio 3:1 (Step 4 revisited) – Determine the Required Motor Torque

Using the equations in **Table 1**:

(Total inertia seen by the motor is the sum of all inertias)

$$J_{\text{total}} = J_{\text{motor}} + J_{\text{gear}} + (J_{\text{coupling}} + J_{\text{screw}} + J_{\text{W}}) \div i^2$$

For this example, we assume the gearbox and coupling inertias are zero.

Load inertia:

$$\begin{aligned} J_{\text{W}} &= (W \div (g \times e)) \times (1 + 2\pi P)^2 \\ &= (200 \div (386 \times 0.9)) \times (1 \div 2 \times 3.1416 \times 1.67)^2 \\ &= 0.00523 \text{ lb-in-sec}^2 \end{aligned}$$

Lead screw inertia:

$$\begin{aligned} J_{\text{screw}} &= (\pi \times L \times p \times r^4) \div (2g) \\ &= (3.1416 \times 23.6 \times 0.28 \times 0.3^4) \div (2 \times 386) \\ &= 0.0002178 \text{ lb-in-sec}^2 \end{aligned}$$

The inertia of the load and screw reflected to the motor is the sum of both values divided by the square of the reduction ratio

$$J_{\text{(screw + load) referred to motor}} = (J_{\text{screw}} + J_{\text{W}}) \div i^2$$

$$J_{\text{total less the motor inertia}} = ((0.0002178 + 0.00523) \div 3^2) = 0.000605 \text{ lb-in-sec}^2$$

The dynamic torque required to accelerate the inertia (without the motor rotor inertia) is:

$$\begin{aligned} T_{\text{accel}} &= J_{\text{total}} \times ((\Delta_{\text{rpm}} \div \Delta_{\text{time}}) \times (2\pi \times 60)) \\ &= 0.000605 \times ((1349 \div 0.2125) \times (2 \times 3.1416 \div 60)) \\ &= 0.4022 \text{ lb-in} \end{aligned}$$

Determine the running torque, or in this case the friction torque:

The forces are:

$F_{\text{total}} = F_{\text{ext}} + F_{\text{friction}} + F_{\text{gravity}}$ [External forces and gravity are zero in this case.]

$$= 0 + (\mu \times W \times \cos\theta) + 0$$

$$= 0.05 \times 200 = 10 \text{ Ib}$$

And the formula to be used is:

$$T_{\text{run}} = ((F_{\text{total}} + (2\pi P)) + T_{\text{preload}}) \div i$$

$$= (10 \div (2 \times 3.1416 \times 1.67)) \div 3 \text{ [related to the motor side]}$$

$$= 0.3177 \text{ Ib-in [where, we have assumed the preload torque to be zero]}$$

From **Equation 5**, the minimum required motor torque @ 1349 rpm is:

$$T_{\text{motor}} = T_{\text{accel}} + T_{\text{run}}$$

$$= (0.4022 \text{ lb-in}) + (0.3177 \text{ lb-in})$$

$$= 0.7199 \text{ lb-in, or 11.51 oz-in}$$

Consider STP-MTR-17048 with the new values:

STP-MTR-17048 Torque vs Speed (1.8° step motor; 1/2 stepping)

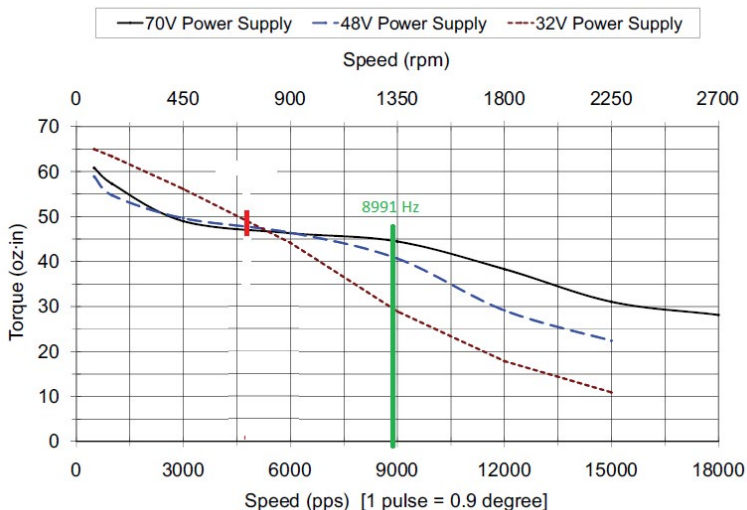

For the purpose of this example, the torque vs. speed curves for this motor at 8.99 kHz will be approximately 26 oz-in at 32VDC and 44 oz-in at 70VDC. Based on the torque, this motor meets the desired 11.51 oz-in requirement.

The rotor inertia, per the motor specification is 0.45 oz-in² or 0.000024 lb-in-sec².

Load/Motor inertia ratio:

$$J_{(\text{screw} + \text{load})} \div J_{\text{motor}} = 0.00605 \text{ lb}\cdot\text{in}\cdot\text{sec}^2 \div 0.000024 \text{ lb}\cdot\text{in}\cdot\text{sec}^2 \\ = 2.52$$

The ratio of 2.52 is below the desired ratio of 10, so the STP-MTR-17048 motor is suitable.

A small change in the mechanical design allowed us to use the motor STP-MTR-17048. The torque in the point of operation is more than enough, and the ratio of inertia criteria is fulfilled with any level of voltage in the drive. To be sure the safety factor is high, it would be better to select a 48V power supply and drive.

Belt Drive – Example Calculations

Step 1 – Define the Actuator and Motion Requirements

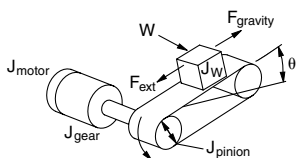

Weight of table and workpiece = 3 lb

External force = 0 lb

Friction coefficient of sliding surfaces = 0.05

Angle of table = 0°

Belt and pulley efficiency = 0.8

Pulley diameter = 1.5 inch

Pulley thickness = 0.75 inch

Pulley material = aluminum

Desired Resolution = 0.001 inch/step

Gear Reducer = 5:1

Stroke = 50 inch

Move time = 4.0 seconds

Accel and decel time = 1.0 seconds

Definitions
d_{load} = lead or distance the load moves per revolution of the actuator's drive shaft ($P = \text{pitch} = 1/d_{load}$)
D_{total} = total move distance
θ_{step} = driver step resolution (steps/rev _{motor})
i = gear reduction ratio (rev _{motor} /rev _{gearshaft})
T_{accel} = motor torque required to accelerate and decelerate the total system inertia (including motor inertia)
T_{run} = constant motor torque requirement to run the mechanism due to friction, external load forces, etc.
t_{total} = move time

Step 2 – Determine the Positioning Resolution of the Load

Rearranging **Equation 4** to calculate the required stepping drive resolution:

$$\begin{aligned} u_{step} &= (d_{load} \div i) \div L_p \\ &= ((3.14 \times 1.5) \div 5) \div 0.001 \\ &= 942 \text{ steps/rev} \end{aligned}$$

where $d_{load} = \pi \times \text{Pulley Diameter}$.

With the 5:1 gear reduction, the stepping system can be set at 1000 steps/rev to slightly exceed the required load positioning resolution.

Reduction is almost always required with a belt drive, and a 5:1 planetary gearhead is common.

Step 3 – Determine the Motion Profile

From **Equation 1**, the total pulses to make the required move is:

$$\begin{aligned} P_{total} &= (D_{total} \div (d_{load} \div i)) \times \theta_{step} \\ &= 50 \div ((3.14 \times 1.5) \div 5) \times 1000 \\ &\approx 53,079 \text{ pulses} \end{aligned}$$

From **Equation 4**, the running frequency for a trapezoidal move is:

$$\begin{aligned} f_{TRAP} &= (P_{total} - (f_{start} \times t_{ramp})) \div (t_{total} - t_{ramp}) \\ &= 53,079 \div (4 - 1) \\ &\approx 17,693 \text{ Hz} \end{aligned}$$

where accel time is 25% of total move time and starting speed is zero.

$$\begin{aligned} &= 17,693 \text{ Hz} \times (60 \text{ sec}/1 \text{ min}) \div 1000 \text{ steps/rev} \\ &\approx 1,062 \text{ RPM motor speed} \end{aligned}$$

Step 4 – Determine the Required Motor Torque

Using the equations in **Table 1**:

$$J_{total} = J_{motor} + J_{gear} + (J_{pulleys} + J_W) \div i^2$$

For this example, let's assume the gearbox inertia is zero.

$$\begin{aligned} J_W &= (W \div (g \times e)) \times r^2 \\ &= (3 \div (386 \times 0.8)) \times 0.752 \\ &\approx 0.0055 \text{ lb-in-sec}^2 \end{aligned}$$

Pulley inertia (remember there are two pulleys) can be calculated as:

$$\begin{aligned} J_{\text{pulleys}} &\approx ((\pi \times L \times p \times r^4) \div (2g)) \times 2 \\ &\approx ((3.14 \times 0.75 \times 0.098 \times 0.754) \div (2 \times 386)) \times 2 \\ &\approx 0.00019 \text{ lb}\cdot\text{in}\cdot\text{sec}^2 \end{aligned}$$

The inertia of the load and pulleys reflected to the motor is:

$$\begin{aligned} J_{(\text{pulleys} + \text{load}) \text{ to motor}} &= (J_{\text{pulleys}} + J_w) \div i^2 \\ &\approx ((0.0055 + 0.00019) \div 52) \approx 0.00023 \text{ lb}\cdot\text{in}\cdot\text{sec}^2 \end{aligned}$$

The torque required to accelerate the inertia is:

$$\begin{aligned} T_{\text{acc}} &\approx J_{\text{total}} \times (\Delta\text{speed} \div \Delta\text{time}) \times 0.1 \\ &= 0.00023 \times (1062 \div 1) \times 0.1 \\ &= 0.025 \text{ lb}\cdot\text{in} \end{aligned}$$

$$T_{\text{run}} = (F_{\text{total}} \times r) \div i$$

$$\begin{aligned} F_{\text{total}} &= F_{\text{ext}} + F_{\text{friction}} + F_{\text{gravity}} \\ &= 0 + \mu W \cos u + 0 = 0.05 \times 3 = 0.15 \text{ lb} \end{aligned}$$

$$\begin{aligned} T_{\text{run}} &= (0.15 \times 0.75) \div 5 \\ &\approx 0.0225 \text{ lb}\cdot\text{in} \end{aligned}$$

From **Equation 5**, the required motor torque is:

$$T_{\text{motor}} = T_{\text{accel}} + T_{\text{run}} = 0.025 + 0.0225 \approx 0.05 \text{ lb}\cdot\text{in}$$

However, this is the required motor torque before we have picked a motor and included the motor inertia.

Step 5 – Select & Confirm the Stepping Motor & Driver System

It looks like a reasonable choice for a motor would be the STP-MTR-17048 or NEMA 17 motor. This motor has an inertia of:

$$J_{\text{motor}} = 0.00006 \text{ lb}\cdot\text{in}\cdot\text{sec}^2$$

The actual motor torque would be modified:

$$\begin{aligned} T_{\text{accel}} &= J_{\text{total}} \times (\Delta\text{speed} \div \Delta\text{time}) \times 0.1 \\ &= (0.00023 + \mathbf{0.00006}) \times (1062 \div 1) \times 0.1 \approx 0.03 \text{ lb}\cdot\text{in} \end{aligned}$$

so that:

$$\begin{aligned} T_{\text{motor}} &= T_{\text{accel}} + T_{\text{run}} \\ &= 0.03 + 0.0225 \approx 0.0525 \text{ lb}\cdot\text{in} \approx 0.84 \text{ oz}\cdot\text{in} \end{aligned}$$

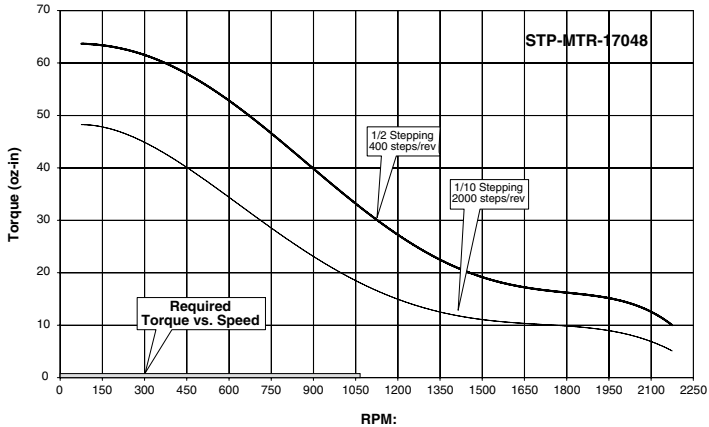

It looks like the STP-MTR-17048 stepping motor will work. However, we still need to check the load to motor inertia ratio:

$$\text{Ratio} = \frac{J_{(\text{pulleys} + \text{load}) \text{ to motor}}}{J_{\text{motor}}} = 0.00023 \div 0.00006 = 3.8$$

It is best to keep the load-to-motor inertia ratio below 10, so 3.8 is within an acceptable range.

Index Table – Example Calculations

Step 1 – Define the Actuator and Motion Requirements

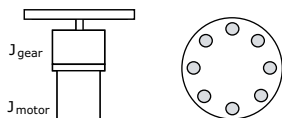

Diameter of index table = 12 inch

Thickness of index table = 2 inch

Table material = steel

Number of workpieces = 8

Desired Resolution = 0.036°

Gear Reducer = 25:1

Index angle = 45°

Index time = 0.7 seconds

Definitions
d_{load} = lead or distance the load moves per revolution of the actuator's drive shaft ($P = \text{pitch} = 1/d_{load}$)
D_{total} = total move distance
θ_{step} = driver step resolution (steps/rev _{motor})
i = gear reduction ratio (rev _{motor} /rev _{gearshaft})
T_{accel} = motor torque required to accelerate and decelerate the total system inertia (including motor inertia)
T_{run} = constant motor torque requirement to run the mechanism due to friction, external load forces, etc.
t_{total} = move time

Step 2 – Determine the Positioning Resolution of the Load

Rearranging **Equation 4** to calculate the required stepping drive resolution:

$$\begin{aligned}\theta_{step} &= (d_{load} \div i) \div L_{\theta} \\ &= (360^\circ \div 25) \div 0.036^\circ \\ &= 400 \text{ steps/rev}\end{aligned}$$

With the 25:1 gear reduction, the stepping system can be set at 400 steps/rev to equal the required load positioning resolution.

It is almost always necessary to use significant gear reduction when controlling a large inertia disk.

Step 3 – Determine the Motion Profile

From **Equation ①**, the total pulses to make the required move is:

$$\begin{aligned} P_{\text{total}} &= (D_{\text{total}} \div (d_{\text{load}} \div i)) \times U_{\text{step}} \\ &= (45^\circ \div (360^\circ \div 25)) \times 400 \\ &= 1250 \text{ pulses} \end{aligned}$$

From **Equation ④**, the running frequency for a trapezoidal move is:

$$\begin{aligned} f_{\text{TRAP}} &= (P_{\text{total}} - (f_{\text{start}} \times t_{\text{ramp}})) \div (t_{\text{total}} - t_{\text{ramp}}) \\ &= 1,250 \div (0.7 - 0.17) \approx 2,360 \text{ Hz} \end{aligned}$$

where accel time is 25% of total move time and starting speed is zero.

$$\begin{aligned} &= 2,360 \text{ Hz} \times (60 \text{ sec}/1 \text{ min}) \div 400 \text{ steps/rev} \\ &\approx 354 \text{ RPM} \end{aligned}$$

Step 4 – Determine the Required Motor Torque

Using the equations in **Table 1**:

$$J_{\text{total}} = J_{\text{motor}} + J_{\text{gear}} + (J_{\text{table}} \div i^2)$$

For this example, let's assume the gearbox inertia is zero.

$$\begin{aligned} J_{\text{table}} &\approx (\pi \times L \times p \times r^4) \div (2g) \\ &\approx (3.14 \times 2 \times 0.28 \times 1296) \div (2 \times 386) \\ &\approx 2.95 \text{ lb}\cdot\text{in}\cdot\text{sec}^2 \end{aligned}$$

The inertia of the indexing table reflected to the motor is:

$$\begin{aligned} J_{\text{table to motor}} &= J_{\text{table}} \div i^2 \\ &\approx 0.0047 \text{ lb}\cdot\text{in}\cdot\text{sec}^2 \end{aligned}$$

The torque required to accelerate the inertia is:

$$\begin{aligned} T_{\text{accel}} &\approx J_{\text{total}} \times (\Delta\text{speed} \div \Delta\text{time}) \times 0.1 \\ &= 0.0047 \times (354 \div 0.17) \times 0.1 \\ &\approx 1.0 \text{ lb}\cdot\text{in} \end{aligned}$$

From **Equation ⑤**, the required motor torque is:

$$\begin{aligned} T_{\text{motor}} &= T_{\text{accel}} + T_{\text{run}} \\ &= 1.0 + 0 = 1.0 \text{ lb}\cdot\text{in} \end{aligned}$$

However, this is the required motor torque before we have picked a motor and included the motor inertia.

Step 5 – Select & Confirm the Stepping Motor & Driver System

It looks like a reasonable choice for a motor would be the STP-MTR-34066, or NEMA 34 motor. This motor has an inertia of:

$$J_{\text{motor}} = 0.0012 \text{ lb-in-sec}^2$$

The actual motor torque would be modified:

$$\begin{aligned} T_{\text{accel}} &= J_{\text{total}} \times (\Delta\text{speed} \div \Delta\text{time}) \times 0.1 \\ &= (0.0047 + 0.0012) \times (354 \div 0.17) \times 0.1 \\ &\approx 1.22 \text{ lb-in} \end{aligned}$$

so that:

$$\begin{aligned} T_{\text{motor}} &= T_{\text{accel}} + T_{\text{run}} \\ &= 1.22 + 0 \\ &= 1.22 \text{ lb-in} = 19.52 \text{ oz-in} \end{aligned}$$

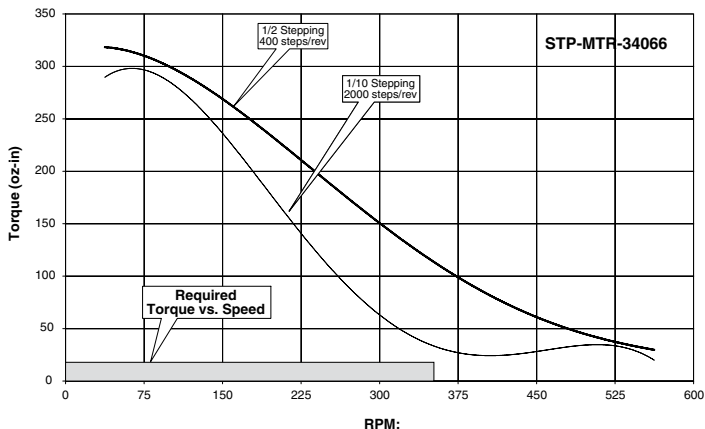

It looks like the STP-MTR-34066 stepping motor will work. However, we still need to check the load to motor inertia ratio:

$$\begin{aligned} \text{Ratio} &= J_{\text{table to motor}} \div J_{\text{motor}} \\ &= 0.0047 \div 0.0012 = 3.9 \end{aligned}$$

It is best to keep the load-to-motor inertia ratio below 10, so 3.9 is within an acceptable range.

Engineering Unit Conversion Tables, Formulae, & Definitions:

Conversion of Length							
To convert A to B, multiply A by the entry in the table.		B					
		μm	mm	m	mil	in	ft
A	μm	1	1.000E-03	1.000E-06	3.937E-02	3.937E-05	3.281E-06
	mm	1.000E+03	1	1.000E-03	3.937E+01	3.937E-02	3.281E-03
	m	1.000E+06	1.000E+03	1	3.937E+04	3.937E+01	3.281E+00
	mil	2.540E+01	2.540E-02	2.540E-05	1	1.000E-03	8.330E-05
	in	2.540E+04	2.540E+01	2.540E-02	1.000E+03	1	8.330E-02
	ft	3.048E+05	3.048E+02	3.048E-01	1.200E+04	1.200E+01	1

Conversion of Torque							
To convert A to B, multiply A by the entry in the table.		B					
		N·m	kg·m	kg·cm	oz·in	lb·in	lb·ft
A	N·m	1	1.020E-01	1.020E+01	1.416E+02	8.850E+00	7.380E-01
	kg·m	9.810E+00	1	1.000E+02	1.390E+03	8.680E+01	7.230E+00
	kg·cm		1.000E-02	1	1.390E+01	8.680E-01	7.230E-02
	oz·in	7.060E-03	7.200E-04	7.200E-02	1	6.250E-02	5.200E-03
	lb·in	1.130E-01	1.150E-02	1.150E+00	1.600E+01	1	8.330E-02
	lb·ft	1.356E+00	1.380E-01	1.383E+01	1.920E+02	1.200E+01	1

Conversion of Moment of Inertia								
To convert A to B, multiply A by the entry in the table.		B						
		$\text{kg}\cdot\text{m}^2$	$\text{kg}\cdot\text{cm}\cdot\text{s}^2$	$\text{oz}\cdot\text{in}\cdot\text{s}^2$	$\text{lb}\cdot\text{in}\cdot\text{s}^2$	$\text{oz}\cdot\text{in}^2$	$\text{lb}\cdot\text{in}^2$	$\text{lb}\cdot\text{ft}^2$
A	$\text{kg}\cdot\text{m}^2$	1	1.020E+01	1.416E+02	8.850E+00	5.470E+04	3.420E+03	2.373E+01
	$\text{kg}\cdot\text{cm}\cdot\text{s}^2$	9.800E-02	1	1.388E+01	8.680E-01	5.360E+03	3.350E+02	2.320E+00
	$\text{oz}\cdot\text{in}\cdot\text{s}^2$	7.060E-03	7.190E-02	1	6.250E-02	3.861E+02	2.413E+01	1.676E-01
	$\text{lb}\cdot\text{in}\cdot\text{s}^2$	1.130E-01	1.152E+00	1.600E+01	1	6.180E+03	3.861E+02	2.681E+00
	$\text{oz}\cdot\text{in}^2$	1.830E-05	1.870E-04	2.590E-03	1.620E-04	1	6.250E-02	4.340E-04
	$\text{lb}\cdot\text{in}^2$	2.930E-04	2.985E-03	4.140E-02	2.590E-03	1.600E+01	1	6.940E-03
	$\text{lb}\cdot\text{ft}^2$	4.210E-02	4.290E-01	5.968E+00	3.730E-01	2.304E+03	1.440E+02	1

Engineering Unit Conversion Tables, Formulae, & Definitions (cont'd):

General Formulae & Definitions	
Description:	Equations:
Gravity	gravity = 9.8 m/s ² ; 386 in/s ²
Torque	$T = J \cdot \alpha$; $\alpha = \text{rad/s}^2$
Power (Watts)	$P (W) = T (N \cdot m) \cdot \omega (\text{rad/s})$
Power (Horsepower)	$P (hp) = T (\text{lb-in}) \cdot v (\text{rpm}) / 63,024$
Horsepower	1 hp = 746W
Revolutions	1 rev = 1,296,000 arc-sec / 21,600 arc-min

Equations for Straight-Line Velocity & Constant Acceleration	
Description:	Equations:
Final velocity	$v_f = v_i + at$ final velocity = (initial velocity) + (acceleration)(time)
Final position	$x_f = x_i + \frac{1}{2}(v_i + v_f)t$ final position = initial position + [(1/2)(initial velocity + final velocity)(time)]
Final position	$x_f = x_i + v_i t + \frac{1}{2}at^2$ final position = initial position + (initial velocity)(time) + (1/2)(acceleration)(time squared)
Final velocity squared	$v_f^2 = v_i^2 + 2a(x_f - x_i)$ final velocity squared = initial velocity squared + [(2)(acceleration)(final position - initial position)]

BLANK
PAGE