

BRX Do-MORE! CPU SPECIFICATIONS



In This Chapter...

The BRX Platform	10-2
Do-more! Designer Software	10-3
BRX Do-more! CPU Common Specifications	10-3
CPU Status Indicators.....	10-6
Mode Switch Functions	10-7
DIP Switch Specifications.....	10-7
Battery Replacement	10-10
microSD Slot	10-11
Customizing the Logo Window	10-12
Replacing Access Covers	10-13
RS-232/485 Port Specifications.....	10-14
Ethernet Port Specifications	10-16
POM Slot.....	10-16

The BRX Platform

The BRX Platform is a very versatile modular Micro PLC system that combines powerful features in a compact standalone footprint. One of the many features that the BRX platform has is the ability to utilize the Do-more! DM1 Technology. This allows the BRX platform to leverage the power of the Do-more! DM1 technology resulting in shorter development time and cost. For example you are able to take an existing Do-more! project that was created using the proven H2-DM1(E) or T1H-DM1(E) CPUs and port the program right into the BRX-DM1(E) CPUs.

The foundation of the platform consists of 4 unique Micro PLC unit (MPU) form factors that incorporates the Do-more! DM1 technology. Shown below are the four unique Micro PLC form factors.

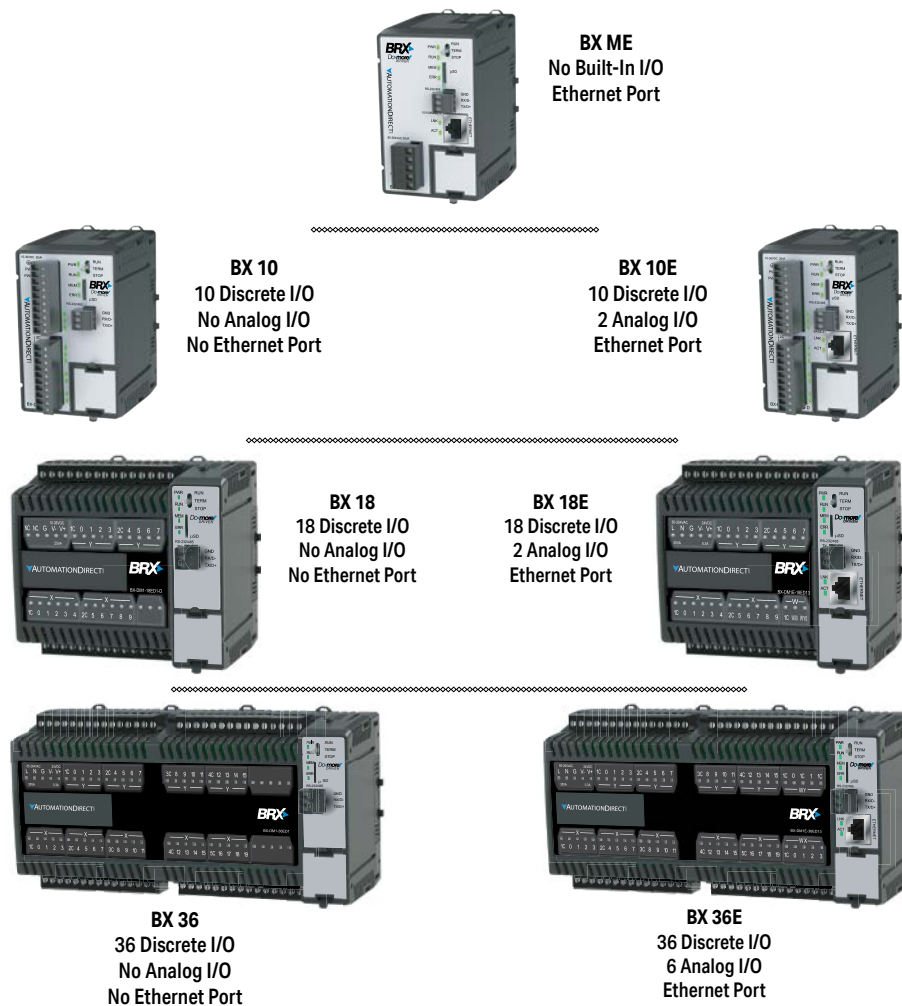

Do-more! Designer Software

The BRX platform uses the Do-more! Designer programming software, which is available as a download from our website. Please see the Do-more! Designer Software Getting Started Guide (DMD-GSG-M) for help on installation and usage of the software.

See <http://support.automationdirect.com/products/domore.html>.

BRX Do-more! CPU Common Specifications

The BRX Do-more! CPUs have standard built-in features such as CPU status indication, a CPU mode selection switch, microSD card slot and a CPU Pluggable Option Module (POM) slot.

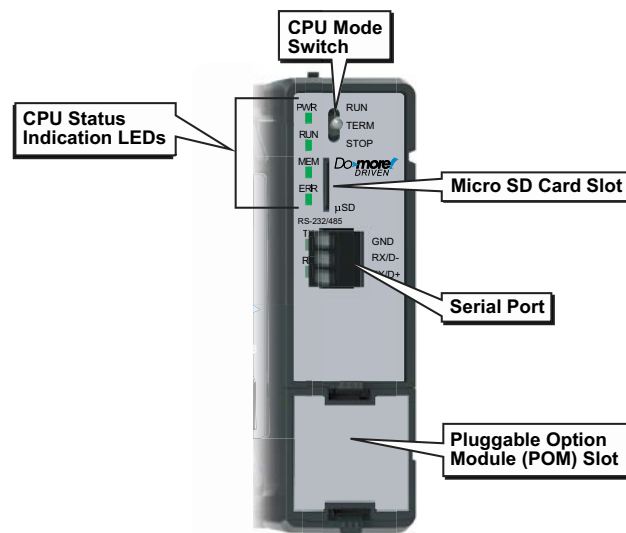

General Specifications	
Operating Temperature	0° to 60°C (32° to 140°F)
Storage Temperature	-20° to 85°C (-4° to 185°F)
Humidity	5 to 95% (non-condensing)
Environmental Air	No corrosive gases permitted
Vibration	IEC60068-2-6 (Test Fc)
Shock	IEC60068-2-27 (Test Ea)
Enclosure Type	Open Equipment
Noise Immunity	NEMA ICS3-304
EU Directive	See the "EU Directive" in Appendix B or topic DMD0331 in the Help File.
Agency Approvals*	UL 61010-2 - UL File # E185989 Canada and USA CE Compliant EN61131-2

* Meets EMC and Safety requirements. See the Declaration of Conformity for details.

MPU Specifications	
Scan Time	50µs 1K Boolean
Serial Port	RS-232/485, 3-Pin, Software configurable
Pluggable Option Module	RS-232, RS-485, Ethernet 10/100, USB 2.0 Type B
Data Logging	microSD card slot (32G max)
Expansion Modules ¹	8 expansion modules
Expansion Module Density	5 ,8, 12, 16 or 32 points/module
Expansion I/O Limits	128 I/O points
Remote Ethernet Slaves	16 slave units
Remote Ethernet Slave Discrete	4096 maximum
Remote Ethernet Slave Analog	4096 maximum
Real Time Clock Accuracy	±2.6 sec per day typical at 25°C ±8s per day max at 60°C
Programming Software ³	Do-more! Designer – Ver. 2.0 or later
Programming Cable Options ²	BX-PGM-CBL
Custom Label Window Size	0.75 in x 2.25 in (19mm x 57.2 mm) (18 & 36 point units only)

1. Always check the power budget to insure that the system can handle all of the expansion IO. Please review Appendix C for power budget information.

2. Can be programmed from any available Serial, Ethernet or USB communications port. Optional programming cable assembly BX-PGM-CBL, includes the BX-USB-P USB POM module and a USB cable which allows programming from the CPU POM option slot.

3. Some expansion modules may have different requirements.

BRX Do-more! Specifications		
Feature	BX-DM1-XXX	BX-DM1E-XXX
User Data Memory Type	Battery Backed RAM, user configurable	
Program Memory	256KB with backup	
Retentive Memory	256KB	
System Configuration	128KB	
Documentation	1MB	
Total Memory	1.8 MB	
Ladder Memory (instruction words)	65,536	
V-Memory (words)	Configurable up to 65536 (4096 default)	
Non-volatile V Memory (words)	Configurable up to 65536 (4096 default)	
D-memory (DWORDs)	Configurable up to 65536 (4096 default)	
Non-volatile D-Memory (DWORDs)	Configurable up to 65536 (4096 default)	
R-memory (REAL DWORDs)	Configurable up to 65536 (4096 default)	
Non-volatile R-Memory (REAL DWORDs)	Configurable up to 65536 (4096 default)	
Stage Programming	Yes	
Number of Stages	128 per program code-block; number of code-blocks configurable to memory limit	
Handheld Programmer	No	
Built-In Communications Ports	RS-232/485	RS-232/485
		Ethernet (10/100 Base-T)
Pluggable Option Module Slot (POM)	1	
Program Memory	Flash ROM	
Total I/O points available	X, Y, each configurable up to 65536 (2048 default); WX, WY (analog in/out) each configurable up to 65536 (256 default)	

Table continued on next page

BRX Do-more! Specifications (continued)		
Feature	BX-DM1-XXX	BX-DM1E-XXX
Number of Instructions Available	>170	>190
Control Relays	Configurable up to 65536 (2048 default)	
Special Relays (system defined)	1024	
Special Registers (system defined)	512	
Timers	Configurable up to 65536 (256 default)	
Counters	Configurable up to 65536 (256 default)	
System Date/Time Structures	8	
User Date/Time Structures	Configurable up to 65536 (32 default)	
Ascii String/Byte Buffer Structures	Configurable up to memory limit (192 default)	
MODBUS Client Memory	Configurable up to memory limit, default 1024 input bits, 1024 coil bits, 2048 input registers, 2048 holding registers	
DL Classic Client Memory	Up to memory limit, default 512 X, 512 Y, 512 C, 2048 V	
Immediate I/O	Yes	
Interrupt Input (hardware / timed)	Yes	
Subroutines	Program, Task, Subroutine Code-blocks, up to memory limit	
Drum Timers	Yes, up to memory limit	
Table Instructions	Yes	
Loops	FOR/NEXT, WHILE/WEND, REPEAT/UNTIL loops	
Math	>60 operators and functions: Integer, Floating Point, Trigonometric, Statistical, Logical, Bitwise, Timing	
ASCII	Yes, IN/OUT, Serial, Ethernet TCP and UDP; 11 output script commands	
PID Loop Control, Built-in	Yes, configurable to memory limit (over 2,000)	
microSD Slot	Several instructions are available to perform data logging and file management interaction on the microSD card.	
Time of Day Clock/Calendar	Yes	
Run Time Edits	Yes	
Supports True Force	Yes	
Internal Diagnostics	Yes	
Password Security	Multi-user, credentialed, session-based security	
System Error Log	Yes	
User Error Log	Yes	
Battery Backup	Yes (Battery included)	

CPU Status Indicators

CPU Status Indicators		
Indicator	Status	Description
PWR	OFF	Base power OFF
	Green	Base power ON
	Yellow	Low battery
RUN	OFF	CPU is in STOP mode
	Green	CPU is in RUN mode
	Yellow	Forces are Active
MEM	OFF	No ROM activity, No SD card
	Yellow	ROM activity (Flash or SD card)
	Green	SD Card installed and mounted*
	Red	SD Card installed and not mounted*
ERR	OFF	CPU is functioning normally
	Red	CPU Fatal Hardware Error or Software Watchdog Error

** A microSD card will become "mounted" to the MPU once the MPU recognizes the microSD card and renders it accessible for use.*

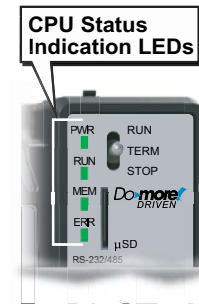

In addition to the individual definition of each LED, there are times when the controller will use combinations of the LED ON/OFF states and colors to convey status information. The following list describes the possible LED combinations:

- ERR LED is blinking RED for (15 seconds) - Do-more! Designer can blink the ERR LED for 15 seconds to verify that a communication link is targeting the correct controller.
- All four (4) of the LEDs are ON and the color of each LED is GREEN - indicates the operating system has started running.
- All four (4) of the LEDs are cycling through RED, GREEN and YELLOW, in a serial 'chase' pattern - indicates the operating system is initializing.
- The four (4) LEDs are cycling through RED and GREEN, in a 'bouncing ball' pattern, this indicates the controller is running only the boot loader and is NOT going to load and run the operating system. The most likely cause is having DIP switch #1 in the ON position.
- All eight (8) of the LEDs are ON and the color of each LED is RED - indicates the hardware watchdog timer has expired because the controller's operating system has stopped running.
- All four (4) of the LEDs are ON and the color of each LED is YELLOW - indicates the PLC has failed to start the OS. To recover from this condition, you can try turning DIP switch #0 ON and updating firmware. If this does not work, the PLC will need to be returned to the manufacturer for recovery.

Mode Switch Functions

The mode switch on the BRX Do-more! CPU allows the user to externally select the different modes of operation. There are three modes available: RUN, TERM and STOP.

CPU Mode Switch Functions	
Position	Function
RUN	CPU is forced into RUN mode if no errors are encountered.
TERM	Allows changing modes (RUN and PROGRAM) using the Do-more! Designer software.
STOP	CPU is forced into STOP mode

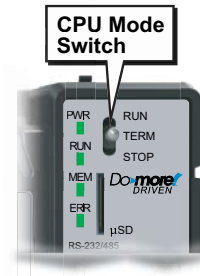

The CPU mode can also be changed through the programming software if the mode switch is placed in the TERM position. In this position, the CPU can be changed remotely between the Run and Program modes. For more information on changing CPU modes through the software, see the *Step 9: Write Project to the BRX MPU* section of Chapter 10 “BRX Do-more! Designer Getting Started”.

When power is applied to the system, the controller will go through its power-up sequence. Then it will either, stay in Program mode if the mode switch is in the STOP position, or attempt to go to Run mode if the mode switch is in the RUN position. If the mode switch is in the TERM position, the CPU will return to the last operational mode before power was lost. For example, if the CPU was in Run mode when power was lost, when power is restored and the mode switch is in the TERM position, the CPU will attempt to return to Run mode.

DIP Switch Specifications

The BRX Do-more! CPU has a block of DIP switches, located on the top of the chassis, that are used to perform various debug and reset operations. The DIP switch settings are only read when the system is first powered up. The default position for all of the DIP switches is OFF.



WARNING: CPU must be powered down prior to changing DIP switch settings!

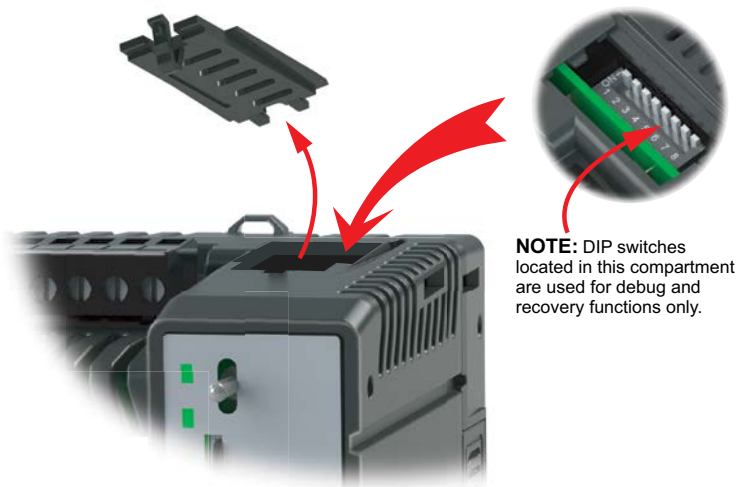

NOTE: DIP switches located in this compartment are used for debug and recovery functions only.

The following table describes the position and function associated with each DIP switch. BRX Do-more! CPUs make use of combinations of DIP switch settings and the Mode switch on the front of the controller to perform two reset functions. These reset functions can only be performed when the CPU is in the Boot Loader portion of the power-up sequence.

DIP Switch Settings		
DIP#	Switch Position	Function
7	ON	Reset the TCP/IP Network Settings to factory default values - Must be used with DIP #1
6	ON	Reserved
5	ON	Reserved
4	ON	Force the Serial port into RS-232 mode with default settings (Programming mode for recovery purposes).
3	ON	Disable ability to update the firmware and/or gate array.
2	ON	Disable the hardware watchdog timer - the hardware watchdog is always enabled, but this switch allows the user to override the ability of the Force Watchdog Error (WATCHDOG) and Debug mode to generate a Watchdog condition.
1	ON	Do not load an Operating System, stay in the Boot Loader.
0	ON	Load the oldest copy of the operating system.



DIP Switch Functions

The following sequence describes the steps necessary to perform one of the reset operations. This combination of DIP switch settings and mode switch manipulation is purposely complex to prevent these reset operations from being accidentally executed.

Clear Only the Network Settings

This reset function will clear ONLY the Network settings, which consists of the Module ID, Module Name, Module Description, IP Address, Subnet Mask and Gateway Address.

1. Begin by powering down the MPU.
2. Record the current DIP switch positions (so they can be set back to their original position after the manual reset is finished).
3. Set ONLY DIP #1 and #7 to ON position to perform the Clear Only the Network Settings operation. Ensure all other DIP switches are in OFF position.
4. Set the CPU mode switch to TERM (the center location) and power up the CPU.
5. At this point the top 4 LEDs (CPU, Run, Mem and Err) should be blinking the 'stay in the boot loader sequence', that is, they should be blinking in sequence, from top to bottom then back to the top, alternating between red and green.
6. Move the CPU mode switch to RUN (to the top).
7. Move the CPU mode switch to TERM (to the center).
8. Move the CPU mode switch to RUN (to the top).
9. Move the CPU mode switch to TERM (to the center).
10. Move the CPU mode switch to STOP (to the bottom).
11. Move the CPU mode switch to TERM (to the center) - the top 4 LEDs should now be ON.

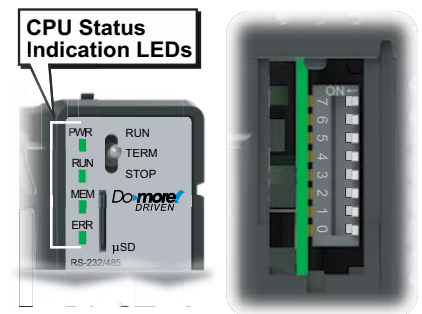



NOTE: If you want to terminate the reset at this point you can do so by moving the CPU mode switch to RUN instead of STOP or power down the MPU.

12. Move the CPU mode switch to STOP (to the bottom) - the bottom 4 LEDs should now be ON.
13. Move the CPU mode switch to TERM (to the center) - the top 4 LEDs begin flashing the power up sequence, and the ROM led should briefly be ON indicating that the data in the ROM is being rewritten. The LEDs will then begin flashing the 'staying in boot loader' sequence indicating the reset is complete.
14. Power down the MPU.
15. Return the DIP switches to their original positions.
16. Set the CPU mode switch to TERM (in the center location).

Reset to Factory Defaults

1. This reset function will clear everything from the CPU, including the Network Settings as described previously, and the System Configuration, Memory Configuration, all control logic, all Documentation, and all of the User Accounts and Passwords.
2. Begin by powering down the MPU.
3. Record the location of the DIP switches (so they can be set back to their original position after the manual reset is finished).
4. Next, set all eight of the DIP switches ON to perform a Reset to Factory Defaults.
5. Set the CPU mode switch to TERM (the center location) and power up the MPU.
6. At this point the top 4 LEDs (CPU, Run, Mem and Err) should be blinking the 'stay in the boot loader sequence', that is, they should be blinking in sequence, from top to bottom then back to the top, alternating between red and green.
7. Move the CPU mode switch to RUN (to the top).
8. Move the CPU mode switch to TERM (to the center).
9. Move the CPU mode switch to RUN (to the top).
10. Move the CPU mode switch to TERM (to the center).
11. Move the CPU mode switch to STOP (to the bottom).
12. Move the CPU mode switch to TERM (to the center) - the top 4 LEDs should now be ON (GREEN).

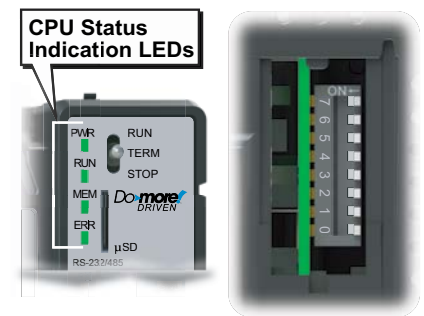

NOTE: If you want to terminate the reset at this point you can do so by moving the CPU mode switch to RUN instead of STOP or power down the MPU.

13. Move the CPU mode switch to STOP (to the bottom) - the Serial and/or Ethernet LEDs should now be ON (GREEN).
14. Move the CPU mode switch to TERM (to the center) - the top 4 LEDs begin flashing the power up sequence, and the ROM led should briefly be ON indicating that the data in the ROM is being rewritten. The LEDs will then begin flashing the 'staying in boot loader' sequence indicating the reset is complete.
15. Power down the MPU.
16. Return the DIP switches to their original positions.
17. Set the CPU mode switch to TERM (in the center location).

Battery Replacement

All BRX MPUs have an onboard battery that maintains the contents of the retentive memory any time the power to the controller is lost. The battery has an expected lifespan of three years; after which the battery will need to be replaced. The battery is a standard CR2032, coin cell battery (AutomationDirect P/N: D0-MC-BAT).

When the controller detects that the battery voltage is too low, and needs to be replaced, the PWR LED will be YELLOW instead of its normal GREEN color. When Do-more! Designer is online with the controller, the system-defined location \$BatteryLow will be ON as well.



NOTE: Retentive memory is not saved automatically when a Do-more! Designer project is saved to disk. Use the Memory Image Manager to create and manage retentive memory data images. Detailed information can be found in Do-more! Designer software help topic DMD0282. It is good practice to make backups of your projects and memory images to recover from unexpected circumstances.

1. Power down the MPU.
2. Remove the battery from its holder located on top of the MPU. Take note of how the battery is aligned in the holder. The battery is removed by pulling on the tape attached to the battery to begin sliding it out of the holder, then grasp the top edge to complete the removal of the battery.

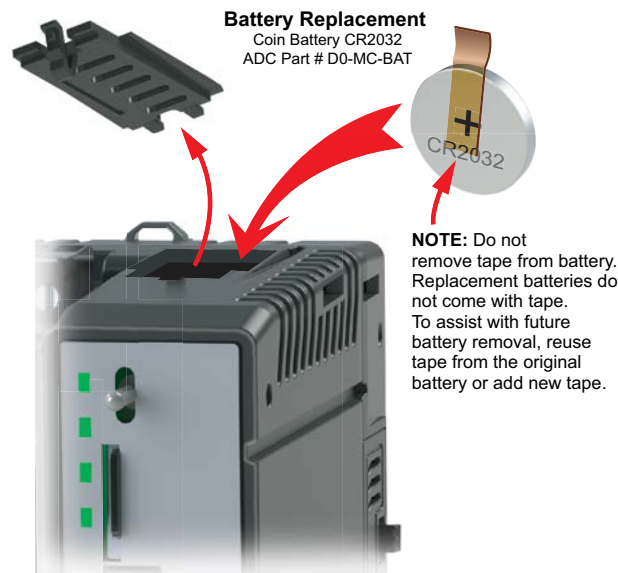

NOTE: The MPU has an onboard capacitor that will maintain the retentive memory contents while the battery is being replaced. The capacitor has a two-hour runtime, which should be more than enough to replace the battery.

Insert the new battery into the holder, making sure the alignment is correct.

Power up the MPU.

Verify that the PWR LED is now GREEN instead of YELLOW and the system-defined location \$BatteryLow will be OFF.

microSD Slot

The BRX Do-more! CPU has data logging and file management instructions that allow a microSD card to be used for data logging and other file storage capabilities. The microSD card must be formatted to FAT32 and a maximum size of 32GB can be used. All card speeds are currently supported.

Insert microSD card with notched side down. Gently press into microSD receptacle until Click. To remove press in microSD card until Click and release. Gently pull microSD card from slot.



NOTE: Card not included with unit. Optional 16G microSD card available (AutomationDirect P/N MICSD-16G).

microSD Specifications				
Port Name	microSD			
Description	Standard microSD socket for data logging or file storage.			
Maximum Card Capacity	32GB			
Transfer Rate (ADATA microSDHC Class 4 memory card)	Mbps	Minimum	Typical	Maximum
	Read	14.3	14.4	14.6
	Write	4.8	4.9	5.1
Port Status LED	Green LED is illuminated when card is inserted/detected.			
Optional microSD Card	ADC Part# MICSD-16G			



Pin	SD
1	DAT2
2	CD/DAT3
3	CMD
4	VDD
5	CLK
6	VSS
7	DAT0
8	DAT1

Customizing the Logo Window



NOTE: The Logo Window feature is only available on the BX 18/18E and BX 36/36E units.

A custom label may be placed in the logo window. The logo window can accommodate label sizes up to 2 1/4" x 3/4".

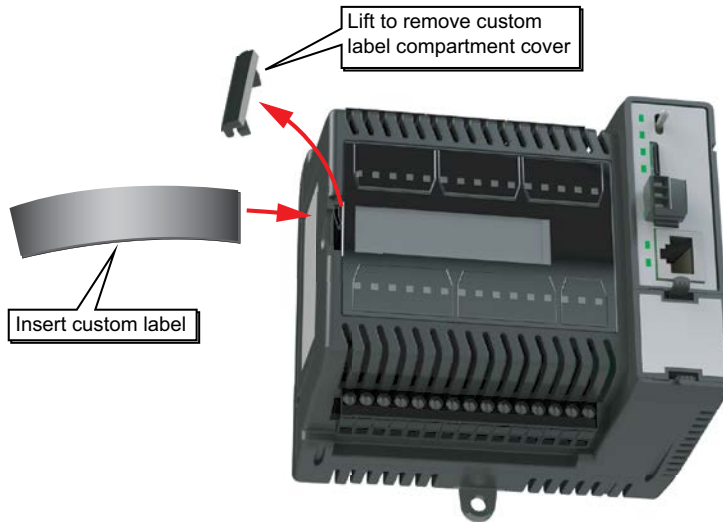

Follow the steps below to add a custom logo/label:

1. Remove the small gray clip at the left edge of the clear plastic window by pulling upward, away from the unit.

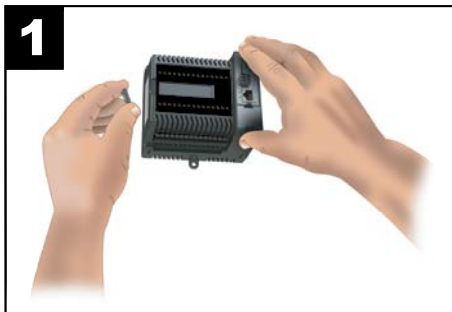

2. If a label has been previously installed you will need to remove the existing label. Needlenose pliers are helpful to grasp the exposed edge of the label

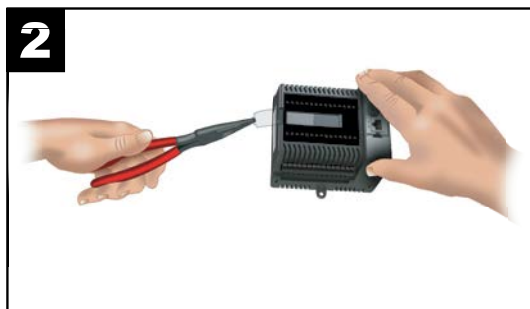



NOTE: Labels do not come with the BRX unit. They must be purchased separately. The part number for the label sheet is BX-LBL-1.

- Remove a plastic label tab from the sheet (Part #BX-LBL-1) and attach a label that you have printed. Avery label models 8987, 6870, 8986 or 8257 may be used.

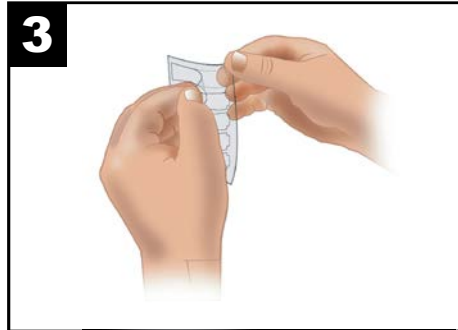

- Slide the plastic tab with attached label into the label slot.

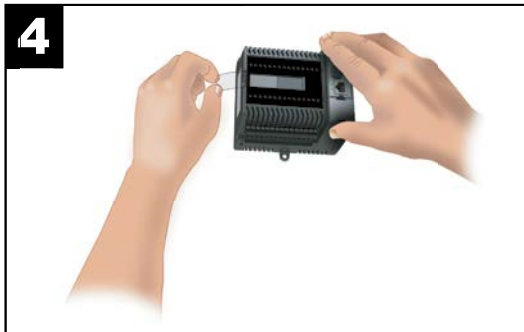

- Reinstall the small gray plastic clip.



The custom logo window can be used to display a company's logo, or a system identification tag, identifying the BRX MPU location and function within your system.

Replacing Access Covers

Replacements for lost or damaged access covers are available in the BRX Access Cover Kit (PN# BX-ACC-1). The kit is for use with all BRX PLCs, and includes (1) battery cover, (1) expansion slot cover, (1) blank POM slot insert and (1) custom label slot cover.

RS-232/485 Port Specifications

The RS-232/485 port utilizes a removable three-pin screw terminal block and is located on the front of the CPU. This port is software selectable to communicate as RS-232 or as RS-485. In the RS-485 mode you can also enable a 120 ohm termination resistor if needed.

The RS-232/485 port can be connected to the Do-more! Designer programming software, Modbus RTU master or slave devices, DirectLogic PLCs via K-Sequence protocol, as well as devices that output non-sequenced ASCII strings or characters.



Built-in RS-232 Specifications	
Port Name	RS-232/RS-485
Description *	Non-isolated Serial port that can communicate via RS-232 or RS-485 (software selectable). Includes ESD protection and built-in surge protection.
Supported Protocols	Do-more!™ Protocol (Slave) (Default) Modbus RTU (Master & Slave) K-Sequence (Slave) ASCII (In & Out)
Data Rates	1200, 2400, 4800, 9600, 19200, 38400, 57600, and 115200 Baud
Default Settings	RS-232, 115200bps, No Parity, 8 Data Bits, 1 Stop Bit, Station #1, Termination resistor OFF
Port Status LED	Green LED is illuminated when active for TXD and RXD
Port Type	Removable 3-pin terminal strip 3.5 mm pitch
RS-232 TXD	RS-232 Transmit output
RS-232 RXD	RS-232 Receive input
RS-232 GND	Logic ground
RS-232 Maximum Output Load (TXD/RTS)	3kΩ, 1000pf
RS-232 Minimum Output Voltage Swing	±5V
RS-232 Output Short Circuit Protection	±15mA
Cable Requirements	RS-232 use P/N Q8604-1 from AutomationDirect.com
Maximum Distance	30 meters (100 feet); 6 meters (20 foot) recommended maximum
Replacement Connector	ADC Part # BX-RTB03S

* When using RS-485 a termination resistor is available and is software selectable.

Built-in RS-485 Specifications	
Port Name	RS-232/RS-485
Description *	Non-isolated Serial port that can communicate via RS-232 or RS-485 (software selectable). Includes ESD protection and built-in surge protection. Includes internal biasing to be a true failsafe receiver while maintaining EIA/TIA-485 compatibility.
Supported Protocols	Do-more!™ Protocol (Slave) (Default) Modbus RTU (Master & Slave) K-Sequence (Slave) ASCII (In & Out)
Data Rates	1200, 2400, 4800, 9600, 19200, 38400, 57600, and 115200 Baud
Default Settings	RS-232, 115200bps, No Parity, 8 Data Bits, 1 Stop Bit, Station #1, Termination resistor OFF
Port Status LED	Green LED is illuminated when active for TXD and RXD
Port Type	Removable 3-pin terminal strip 3.5 mm pitch
RS-485 Station Addresses	1–247
TXD-/RXD-	RS-485 transceiver low
TXD+/RXD+	RS-485 transceiver high
RS-485 GND	Logic ground
RS-485 Input Impedance	19kΩ
RS-485 Maximum Load	50 transceivers, 19kΩ each, 120Ω termination
RS-485 Output Short Circuit Protection	±250mA, thermal shut-down protection
RS-485 Electrostatic Discharge Protection	±8kV per IEC1000-4-2
RS-485 Electrical Fast Transient Protection	±2kV per IEC1000-4-4
RS-485 Minimum Differential Output Voltage	1.5 V with 60Ω load
RS-485 Fail Safe Inputs	Logic high input state if inputs are unconnected
RS-485 Maximum Common Mode Voltage	-7.5 V to 12.5 V
Cable Requirements	RS-485 use P/N L19954-XXX from AutomationDirect.com
Maximum Distance	1000 meters (3280 feet)
Replacement Connector	ADC Part # BX-RTB03S

* When using RS-485 a termination resistor is available and is software selectable.

Ethernet Port Specifications



NOTE: This section applies only to the units with the Built-in Ethernet port. These models include all BRX CPUs with the DM1E technology which includes BX ME, BX 10E, BX 18E and BX 36E.

The Ethernet port utilizes a standard RJ-45 connector and is located on the front of the CPU just below the serial port. This port uses the 10/100BASE-T standard and has built-in auto-crossover capability allowing the use of any standard patch cable or crossover cable.

Ethernet Port Specifications	
Port Name	ETHERNET
Ethernet Port Type	RJ45, Category 5, 10/100 BASE-T, Auto Crossover
Description	Standard transformer isolated Ethernet port with built-in surge protection
Transfer Rate	10 Mbps (Orange LED) and 100 Mbps (Green LED)
Port Status LED	LED is solid when network LINK is established. LED flashes when port is active (ACT).
Supported Protocols	Do-more! Protocol Ethernet Remote I/O Modbus TCP (Client, Server) EtherNet/IP: Explicit Messaging Scanner/Adapter Implicit Messaging Scanner/Adapter HOST ECOM (DirectLogic) Peerlink Embedded Web Server, HTTP (Unsecure) SMTP (Email) SNTP (Time Server) TCP/IP UDP/IP (Raw packet)
Cable Recommendation	C5E-STxxx-xx from AutomationDirect.com
Ethernet Port Numbers	
Modbus TCP	502, TCP (Configurable)
EtherNet I/P	44818, UDP (Configurable)
HOST ECOM	28784, UDP (Configurable)
Do-more! Protocol	28784, UDP (Configurable)

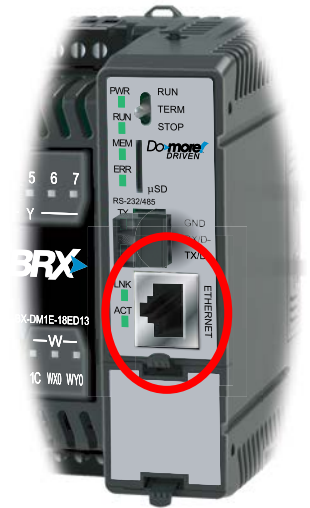

POM Slot

The POM slot allows for an additional communication port, as an Ethernet, USB or serial protocol. See Chapter 6: BRX Pluggable Option Module (POM) for port options.